

# MODEL 15S - INCREMENTAL SHAFT ENCODER



Ø1.5"

## FEATURES

- High performance economical encoder
- Low profile – less than 1.0" (25.4 mm) height and 1.5" (38 mm) diameter
- Extended temperature operating ranges available
- Up to 12 pole commutation optional (for brushless motor control)

The Model 15S Accu-Coder™ offers a high performance feedback solution in a low profile package, making the Model 15S ideal for commercial and light-duty industrial applications. This industry standard Size 15 (1.5" diameter) encoder features a precision bearing set, sealing available to IP64, a durable stainless steel shaft, and a selection of servo, flange, and face mount options. The Model 15S may also be specified with features such as extended operating temperatures from -40° C to 120° C, and up to 12 pole commutation for brushless motor control. The Model 15S features EPC's Opto-ASIC circuitry for a clean, reliable signal. Its durable yet economical design makes it an ideal encoder for high precision OEM applications.

## COMMON APPLICATIONS

Servo Motor Control, Robotics, Medical Diagnostic Equipment, Specialty Assembly Machines, Digital Plotters, Printers, Typesetting Equipment

## MODEL 15S ORDERING GUIDE

Blue type indicates price adder options. Not all configuration combinations may be available. Contact Customer Service for details.

Mechanical			Electrical				Optional Features - Leave blank for standard options																												
<b>15S</b>	<b>19</b>	<b>M1</b>	<b>0500</b>	<b>N</b>	<b>5</b>	<b>A</b>	<b>OC</b>	<b>F00</b>	-20° to 85° C Std	IP50 Std	None Std																								
<b>MODEL</b> 15S Shaft mount	<b>SHAFT SIZE<sup>1</sup></b> 21 3/16", 0.1875" 23 4 mm 19 1/4", 0.250" 20 6 mm	<b>CYCLES PER REVOLUTION</b> See CPR Options below Price adder for >1800	<b>COMMUTATION<sup>2</sup></b> N No commutation A 4 Pole B 6 Pole C 8 Pole E 10 Pole D 12 Pole	<b>INPUT VOLTAGE</b> 5 5 VDC V1 5 to 28 VDC	<b>CONNECTOR TYPE<sup>6</sup></b> F00 18" Cable <sup>7</sup> (Std) F01 12" Cable F02 24" Cable F03 36" Cable M00 2M Cable <sup>7</sup> J00 18" Cable with 5-pin M12 <sup>8</sup> K00 18" Cable with 8-pin M12 <sup>8</sup> A00 15-pin Header with 18" Cable <sup>9</sup>	<b>OPERATING TEMPERATURE</b> -20° to 85° C (Std) T1 -40° to 85° C T2 -20° to 100° C T3 -20° to 120° C <sup>10</sup> T7 -40° to 120° C <sup>10</sup>	<b>CERTIFICATION</b> None (Std) CE CE Marked <sup>11</sup>	<b>OUTPUT TYPE</b> OC Open Collector PP Push-Pull HV Line Driver PU Pull-Up Resistor <sup>5</sup> OD Open Collector with Differential Outputs <i>Available on special request.</i> <i>Additional lead times may apply:</i> LO Line Driver on ABZ Open Collector on UVW <sup>5</sup>	<b>MAXIMUM FREQUENCY</b> Standard F3 Extended See Specifications	<b>SEALING</b> IP50 (Std) S1 IP64																									
<b>MOUNTING</b> M1 3 hole 28 mm BC Servo Mount M2 3 hole 1.210" BC Servo Mount M3 2.093" Square Flange M4 2.096" Servo Mount M5 4 hole 1.100" Servo Mount M6 4 hole 1.000" Servo Mount M7 4 hole 1.181" Servo Mount M8 3 hole 1.181/1.260" Servo Mount M9 3 hole 1.210" BC Servo Mount	<b>NUMBER OF CHANNELS<sup>3</sup></b> A Channel A <i>Channel A Leads B</i> Q Quadrature A & B R Quadrature A & B with Index <i>Channel B Leads A<sup>4</sup></i> K Reverse Quadrature A & B D Reverse Quadrature A & B with Index	<b>Model 15S CPR Options</b>																																	
			<table border="1"> <tr> <td>0001 thru 0189</td> <td>0198</td> <td>0200</td> <td>0250</td> <td>0256</td> </tr> <tr> <td>0300</td> <td>0315</td> <td>0360</td> <td>0400</td> <td>0500</td> </tr> <tr> <td>0580</td> <td>0600</td> <td>0750</td> <td>0800</td> <td>1000</td> </tr> <tr> <td>1200</td> <td>1250</td> <td>1500</td> <td>1800</td> <td>2000</td> </tr> <tr> <td>2500</td> <td>2540</td> <td>3000</td> <td>3600</td> <td>4000</td> </tr> <tr> <td>5000</td> <td>6000</td> <td>7200</td> <td>8192</td> <td>10,000</td> </tr> </table>			0001 thru 0189	0198	0200	0250	0256	0300	0315	0360	0400	0500	0580	0600	0750	0800	1000	1200	1250	1500	1800	2000	2500	2540	3000	3600	4000	5000	6000	7200	8192	10,000
0001 thru 0189	0198	0200	0250	0256																															
0300	0315	0360	0400	0500																															
0580	0600	0750	0800	1000																															
1200	1250	1500	1800	2000																															
2500	2540	3000	3600	4000																															
5000	6000	7200	8192	10,000																															

### NOTES:

- Contact Customer Service for additional options not shown.
- Not available in all configurations, and not available with V1 Input Voltage. Contact Customer Service for availability.
- Contact Customer Service for non-standard index gating or phase relationship options, or see Quadrature Phasing and Index Gating Options at encoder.com.
- Reverse Quadrature not available with PU output type.
- With Input Voltage above 16 VDC, operating temperature is limited to 85° C.
- For mating connectors, cables, and cordsets see Accessories at encoder.com. For Connector Pin Configuration Diagrams, see Connector Pin Configuration Diagrams at encoder.com.
- For non-standard English cable lengths enter 'F' plus cable length expressed in feet. Example: F06 = 6 feet of cable. For non-standard metric cable lengths enter 'M' plus cable length expressed in meters. Example: M06 = 6 meters of cable. Frequency above 300 kHz standard cable lengths only.
- Not available with commutation. 5-pin not available with Line Driver (HV, OD, LO) outputs. Additional cable lengths available. Please contact Customer Service.
- Pin Header available with 5 VDC Input Voltage, HV Line Driver and standard quadrature phasing only. Not available with CE Certification. IP50 sealing option only.
- Only available with 5 VDC Input Voltage.
- Please refer to Technical Bulletin TB100: When to Choose the CE Mark at encoder.com.

# MODEL 15S - INCREMENTAL SHAFT ENCODER

## MODEL 15S SPECIFICATIONS

### Electrical

Input Voltage.....	5 VDC +10% Fixed Voltage 4.75 to 28 VDC max for temperatures up to 85° C 4.75 to 24 VDC for temperatures between 85° to 100° C
Input Current.....	.140 mA max (65 mA typical for most configurations) with no output load
Output Format.....	Incremental – Two square waves in quadrature with channel A leading B for clockwise shaft rotation, as viewed from the encoder mounting face. See Waveform Diagrams.
Output Types.....	Open Collector – 20 mA max per channel Push-Pull – 20 mA max per channel Pull-Up – Open Collector with 2.2K ohm internal resistor, 20 mA max per channel Line Driver – 20 mA max per channel (Meets RS 422 at 5 VDC supply.)
Index.....	Once per revolution. 1 to 400 CPR: Ungated 401 to 10,000 CPR: Gated to output A See Waveform Diagrams.
Max. Frequency.....	Standard Frequency Response is 200 kHz for CPR 1 to 2540 500 kHz for CPR 2541 to 5000 1 MHz for CPR 5001 to 10,000 Extended Frequency Response (optional) is 300 kHz for CPR 2000, 2048, 2500, and 2540.
Electrical Protection.....	Reverse voltage and output short circuit protected. NOTE: Sustained reverse voltage may result in permanent damage.
Noise Immunity.....	Tested to BS EN61000-6-2; BS EN50081-2; BS EN61000-4-2; BS EN61000-4-3; BS EN61000-4-6; BS EN500811
Quadrature.....	.67.5° electrical or better is typical,
Edge Separation.....	.54° electrical minimum at temperatures > 99° C
Waveform Symmetry.....	.180° (±18°) electrical (single channel encoder)
Accuracy.....	Within 0.017° mechanical or 1 arc-minute from true position (for CPR >189).
Commutation.....	Up to 12 pole. Contact Customer Service for availability.
Comm. Accuracy.....	1° mechanical

### Mechanical

Max Shaft Speed.....	8000 RPM. Higher speeds may be achievable, contact Customer Service.
Shaft Material.....	Stainless Steel
Radial Shaft Load.....	.5 lb max. Rated load of 2 to 3 lb for bearing life of 1.2 x 10 <sup>10</sup> revolutions
Axial Shaft Load.....	.5 lb max. Rated load of 2 to 3 lb for bearing life of 1.2 x 10 <sup>10</sup> revolutions
Starting Torque.....	IP50- 0.05 oz-in IP64- 0.4 oz-in
Moment of Inertia.....	.67 x 10 <sup>-5</sup> oz-in-sec <sup>2</sup> (4.8 gm-cm <sup>2</sup> )
Weight.....	.3 oz typical

### Environmental

Storage Temp.....	-25° to 85° C
Humidity.....	98% RH non-condensing
Vibration.....	10 g @ 58 to 500 Hz
Shock.....	.80 g @ 11 ms duration
Sealing.....	IP50 standard; IP64 available

## MODEL 15S STANDARD SERVO MOUNT M1

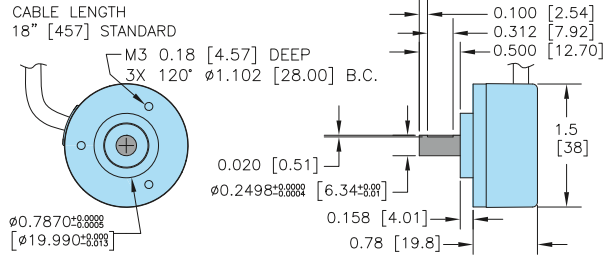

## MODEL 15S SERVO MOUNT M2 & M9\*

\*M9 mount includes a 0.750" boss

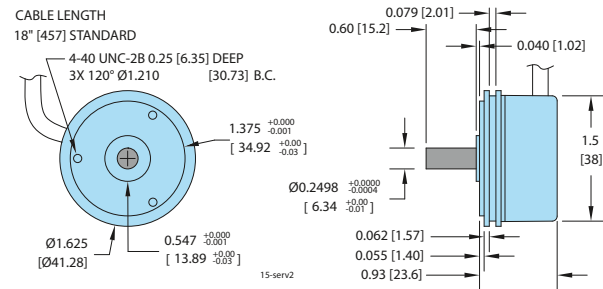

## MODEL 15S SERVO MOUNT M5

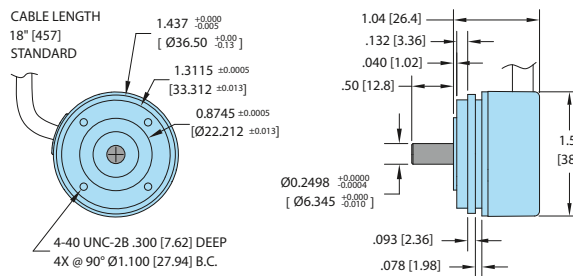

## MODEL 15S SERVO MOUNT M6

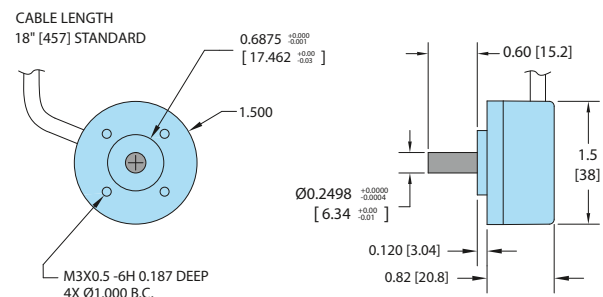

All dimensions are in inches with a tolerance of +0.005" or +0.01" unless otherwise specified. Metric dimensions are given in brackets [mm].

# MODEL 15S - INCREMENTAL SHAFT ENCODER

## MODEL 15S STANDARD SERVO MOUNT M7

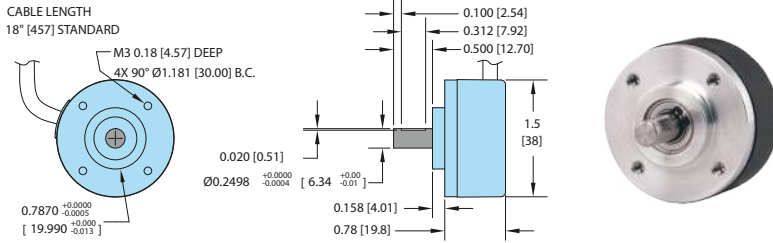

## MODEL 15S SERVO MOUNT M4

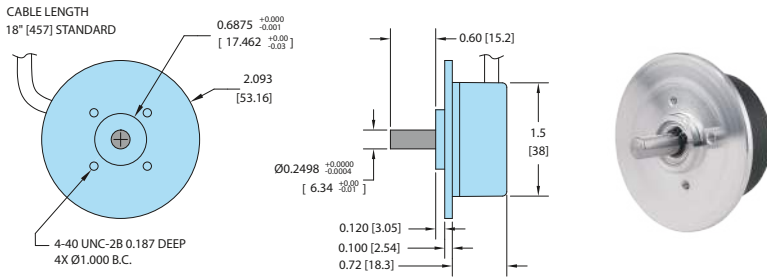

## MODEL 15S SERVO MOUNT M3

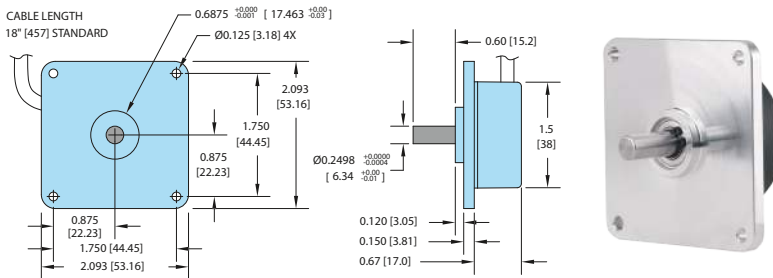

## MODEL 15S SERVO MOUNT M8

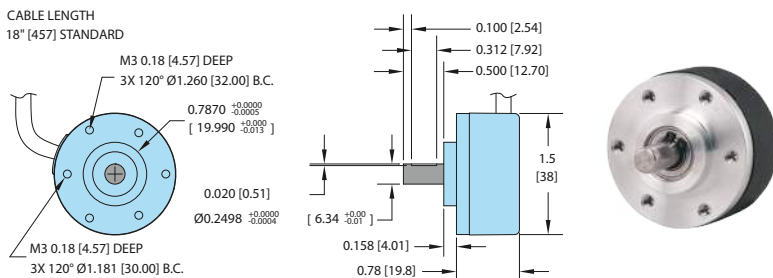

All dimensions are in inches with a tolerance of +0.005" or +0.01" unless otherwise specified. Metric dimensions are given in brackets [mm].

# MODEL 15S - INCREMENTAL SHAFT ENCODER

## WAVEFORM DIAGRAMS

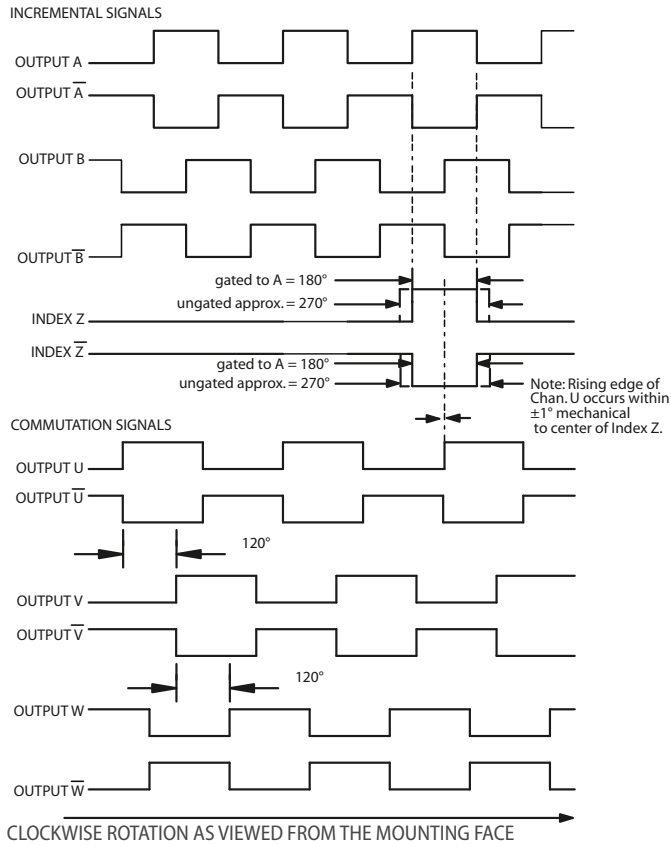

NOTE: ALL DEGREE REFERENCES ARE ELECTRICAL DEGREES. Waveform shown with optional complementary signals  $\bar{A}$ ,  $\bar{B}$ ,  $\bar{Z}$  for HV and OD outputs only.

### 15-pin header

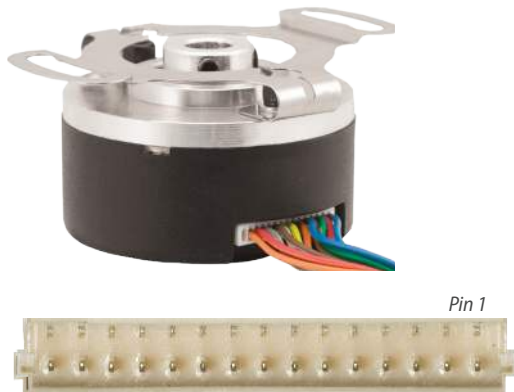

## WIRING TABLE

For EPC-supplied mating cables, refer to wiring table provided with cable. Trim back and insulate unused wires.

Function	Flying Leads Cable† Wire Color	5-pin M12**	8-pin M12**	15-pin Header
Com	Black	3	7	1
+VDC	White	1	2	2
A	Brown	4	1	4
A'	Yellow	--	3	3
B	Red	2	4	6
B'	Green	--	5	5
Z	Orange	5	6	7
Z'	Blue	--	8	8
U	Violet	--	--	10
U'	Gray	--	--	9
V	Pink	--	--	14
V'	Tan	--	--	13
W	Red/Green	--	--	12
W'	Red/Yellow	--	--	11
Shield	Bare*	--	--	--

\*CE Option: Cable shield (bare wire) is connected to internal case.

†Standard cable for non-commutated models is 24 AWG For commutated units, conductors are 28 AWG.

\*\*CE Option: Use cable cordset with shield connected to M12 connector coupling nut.