

6

5

4

3

2

1

APPROVED: _____

DATE: _____ TITLE: _____

Rev	AWO #	Description	Date	Appr
-		RELEASED	9/5/19	

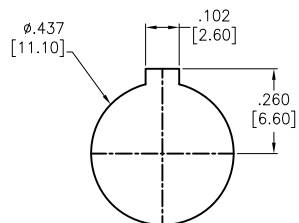

RECOMMENDED PANEL CUT

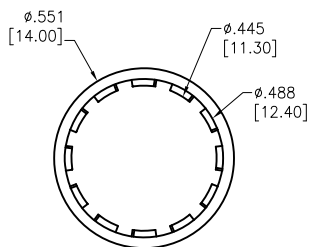
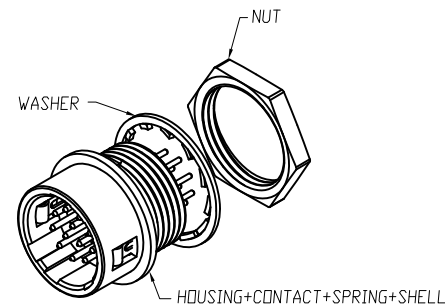
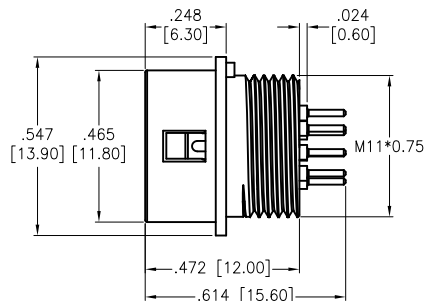
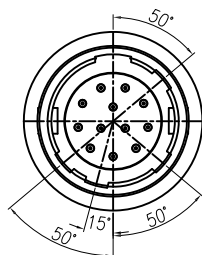

WASHER

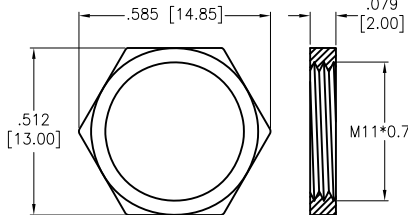
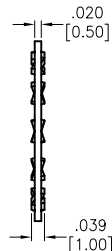

NUT

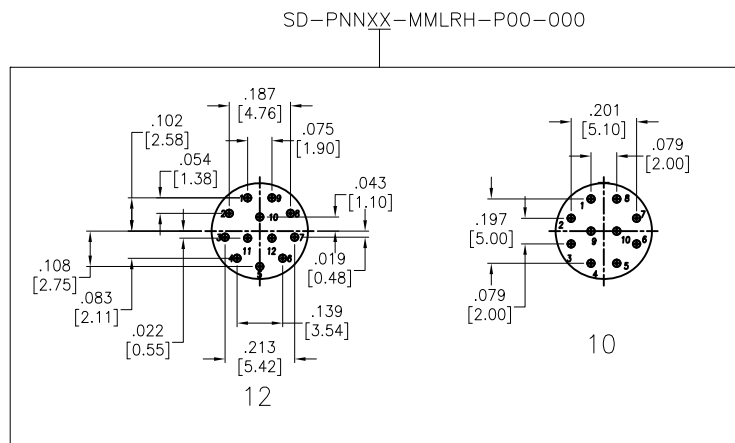

SD-PNNXX-MMLRH-P00-000

SPECIFICATIONS:

- Material:
- Housing: Nylon 46, rated UL 94V-0, Color: Black
- Contacts: Brass, Gold Flash over Nickel
- Shell: Zinc Alloy, Nickel plated
- Spring: Stainless Steel
- Washer: Phosphor Bronze, Nickel plated
- Nut: Brass, Nickel plated
- Environmental:
- Lead free, RoHS compliant



UNLESS OTHERWISE SPECIFIED
 ALL DIMENSIONS ARE INCHES [MM]
 TOLERANCES: EXCEPT AS NOTED

INCHES		HOLES	
.X	± .10	Ø.X	± .10
.XX	± .020	Ø.XX	± .015
.XXX	± .015	Ø.XXX	± .010

ADAM TECH
 INTERCONNECTS

909 Rahway Avenue,
 Union, NJ 07083
 Phone: 908-687-5000
 Fax: 908-687-5710

APPROVALS		DATE
DRAWN	LH	9/5/19
CHECKED	RC	9/5/19
APPROVED		

TITLE WATERPROOF CONNECTOR, MALE DIN, REAR PANEL, SHELL LOCK TYPE, STR PCB		
SIZE X	PART NO. SD-PNNXX-MMLRH-P00-000	REV. -
REF: S00298T	SCALE: NTS	SHEET 1 OF 1

6

5

4

3

2

1