

455870003  
FIRST GENERATION POLARIZATION

- NOTES:
- 1) MATERIAL:  
HOUSING: NYLON, UL94V-0, COLOR: BLACK
  - 2) FINISH: NONE
  - 3) PRODUCT SPECIFICATION: PS-45558-001
  - 4) PACKAGING: PER PK-5557-002
  - 5) 455870003 RECEPTACLE HOUSING MATES WITH 455860001 AND 455860004 HEADER ASSEMBLIES; 455870002 RECEPTACLE HOUSING MATES WITH 455860002 HEADER ASSEMBLY. 455870004 RECEPTACLE HOUSING MATES WITH 455860005 HEADER ASSEMBLY.
  - 6) PART TO BE USED WITH MOLEX FEMALE TERMINAL SERIES 5556.
  - 7) ALL DIMENSIONS ARE REFERENCE UNLESS OTHERWISE SPECIFIED WITH A TOLERANCE.
  - 8) PART IS NOT DESIGNED FOR CURRENT SHARING.
  - 9) PARTS ARE NOT TO BE MATED OR UNMATED WHILE CIRCUITS ARE LIVE.
  - 10) RIB INDICATES CIRCUIT NUMBER 1.
  - 11) PART CONFORMS TO CLASS "B" REQUIREMENTS OF COSMETIC SPECIFICATION PS-45499-002.
  - 12) WIRES ARE TO BE DRESSED IN SUCH A MANNER TO ALLOW THE TERMINALS TO FLOAT FREELY IN THE POCKET

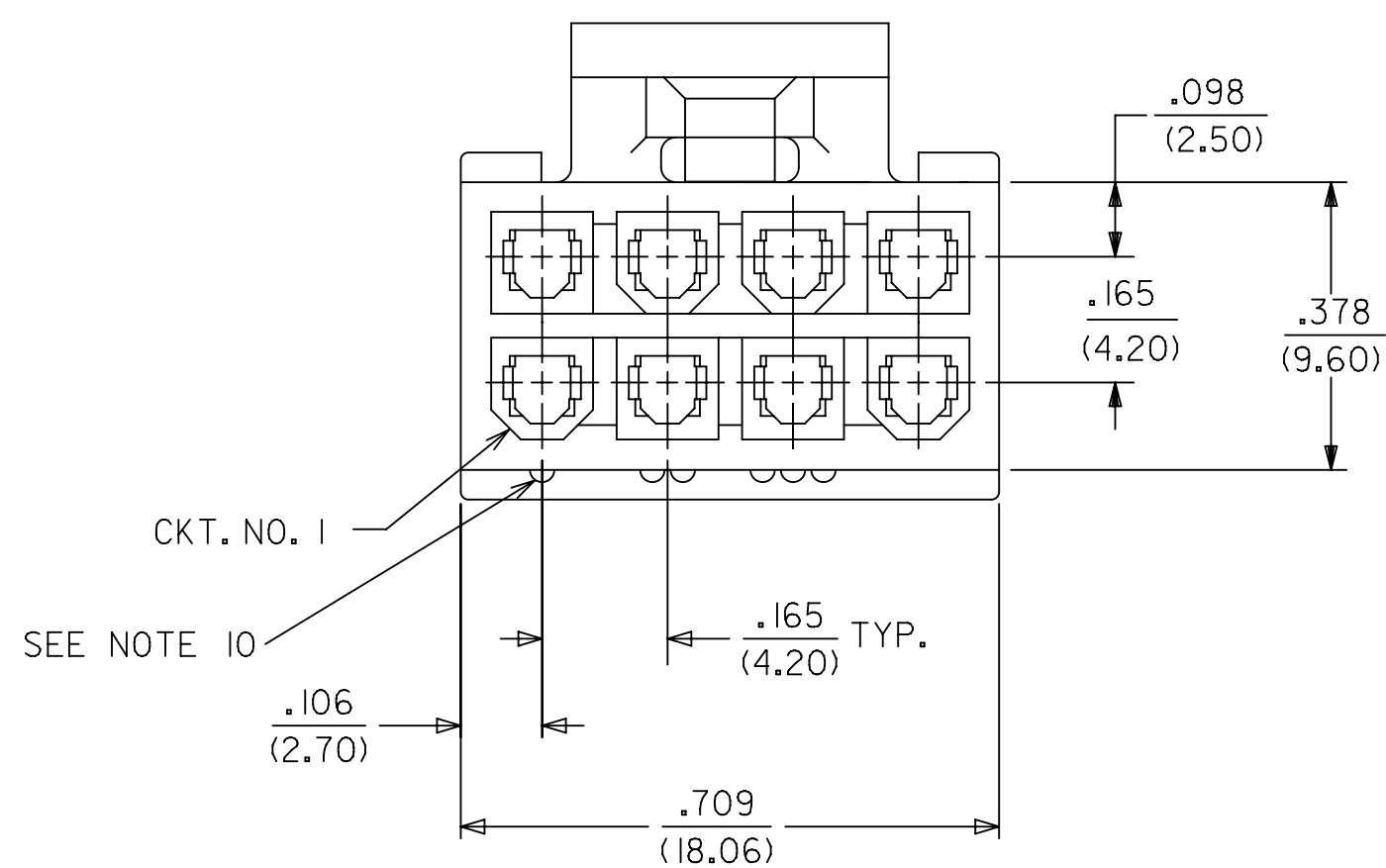

CIRCUIT SIZE	PART NUMBER	POLARIZATION TYPE
8	455870003	FIRST GENERATION
	455870002	SECOND GENERATION
	455870004	THIRD GENERATION

THIS DRAWING CONTAINS INFORMATION THAT IS PROPRIETARY TO MOLEX ELECTRONIC TECHNOLOGIES, LLC AND SHOULD NOT BE USED WITHOUT WRITTEN PERMISSION											
DIMENSION UNITS		SCALE		CURRENT REV DESC:				DOCUMENT NUMBER			
mm	NTS					<b>molex</b>					
GENERAL TOLERANCES (UNLESS SPECIFIED)				8 CKT. RECEPT. HOUSING SPECIAL POLARIZATION MINI-FIT JR. SERIES							
4 PLACES	±	MM	INCH	EC NO: 726879				PRODUCT CUSTOMER DRAWING			
3 PLACES	±			DRWN: JERRYW8 2022/11/02							
2 PLACES	±	0.25	± 0.015	CHK'D: XQZHANG 2022/11/07							
1 PLACE	±	0.38	±	APPR: XQZHANG 2022/11/07							
0 PLACES	±			INITIAL REVISION:				DOCUMENT NUMBER			
ANGULAR TOL ± 5.0 °				DRWN: CLS 2003/07/15				SD-45587-001			
DRAFT WHERE APPLICABLE MUST REMAIN WITHIN DIMENSIONS				APPR: FSMITH 2011/03/01				DOC TYPE   DOC PART   REVISION			
THIRD ANGLE PROJECTION				DRAWING				MATERIAL NUMBER			
C-SIZE				SERIES				CUSTOMER			
				45587				GENERAL MARKET			
								SHEET NUMBER			
								1 OF 2			

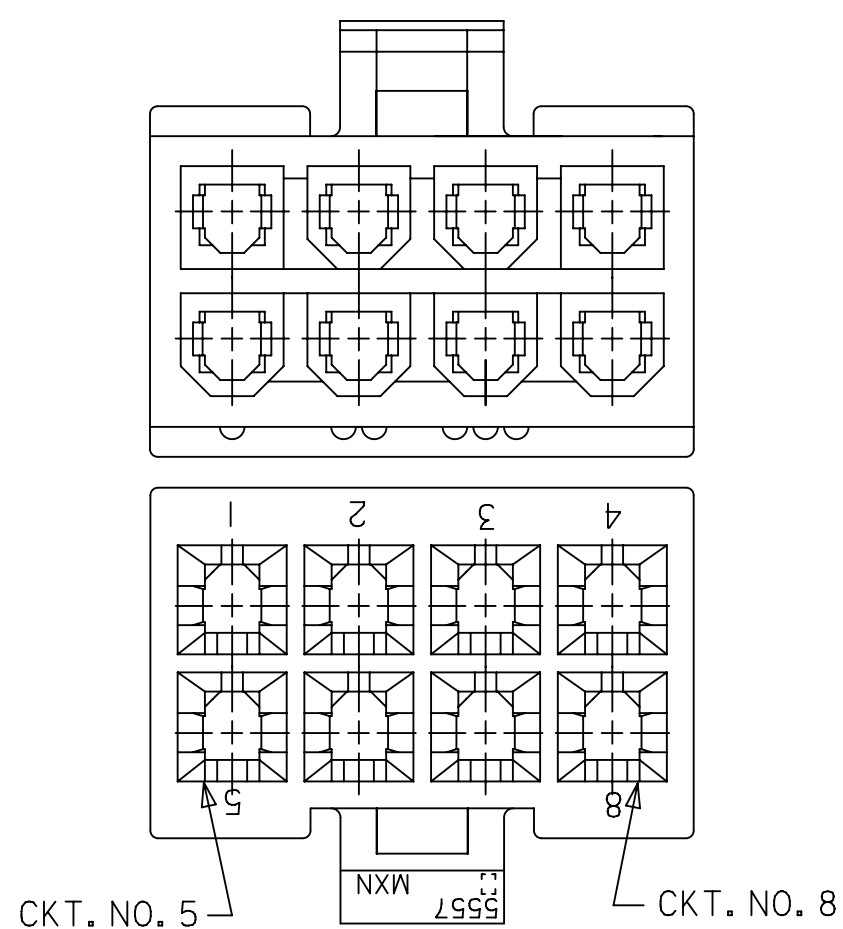

455870002  
SECOND GENERATION POLARIZATION

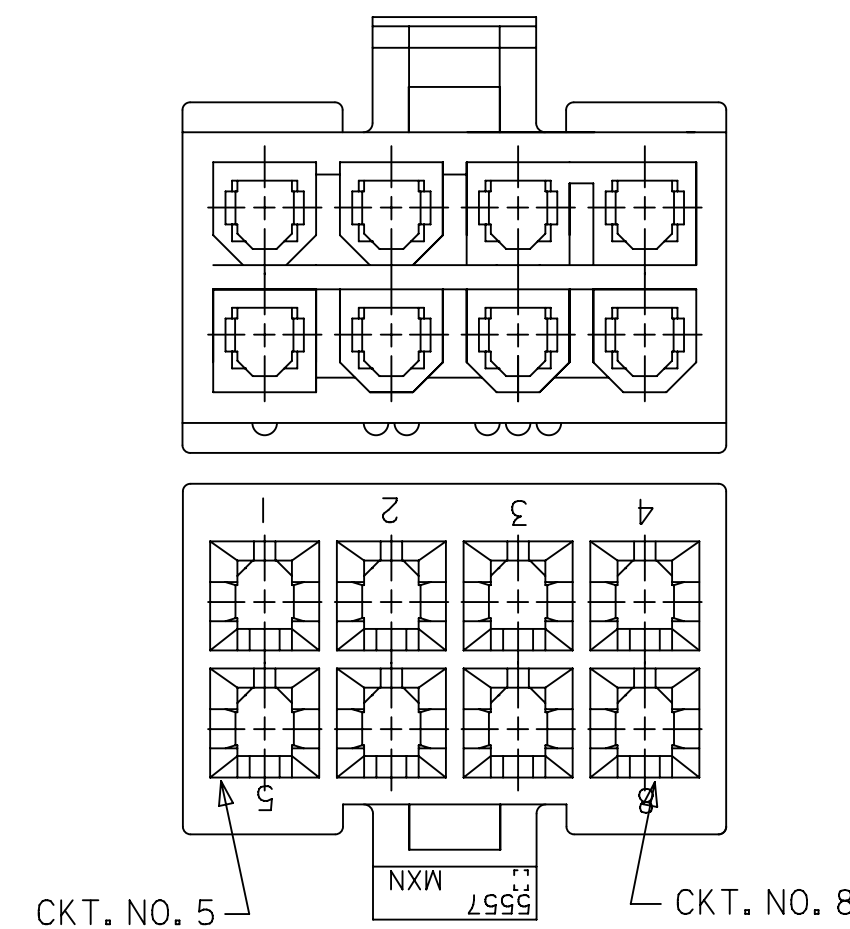

455870004  
THIRD GENERATION POLARIZATION

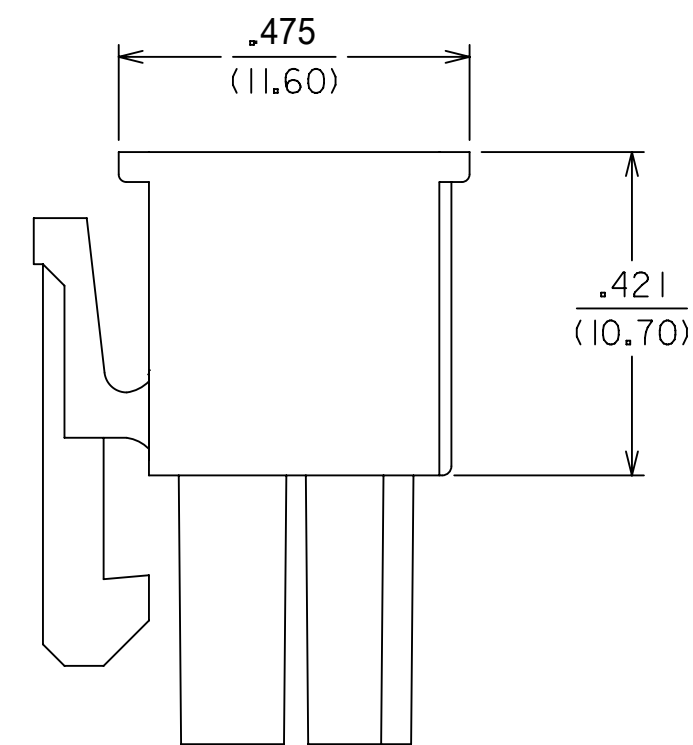
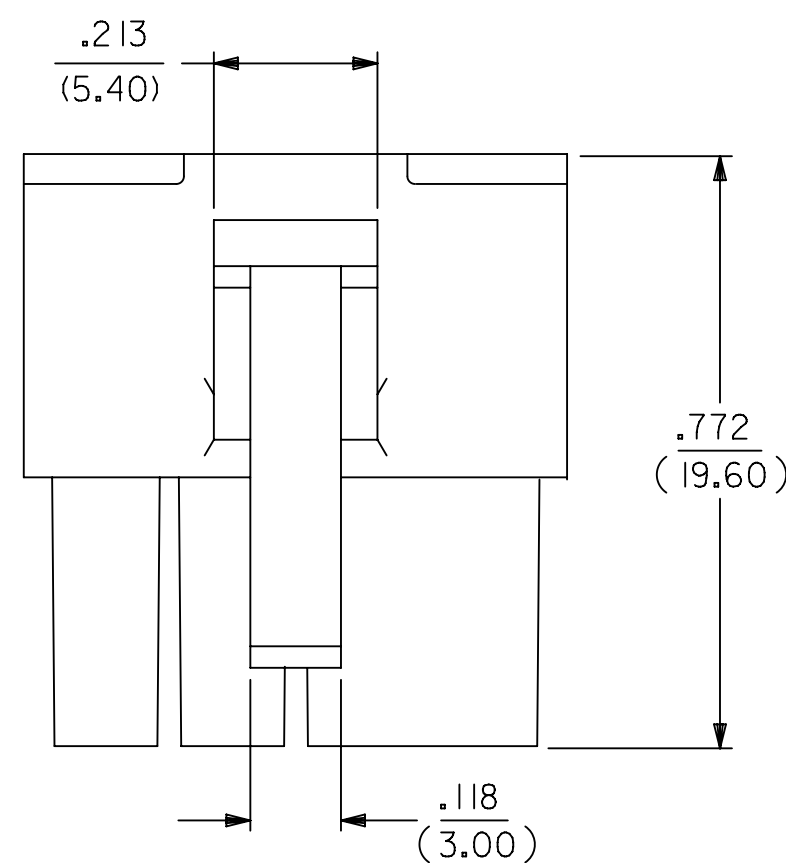
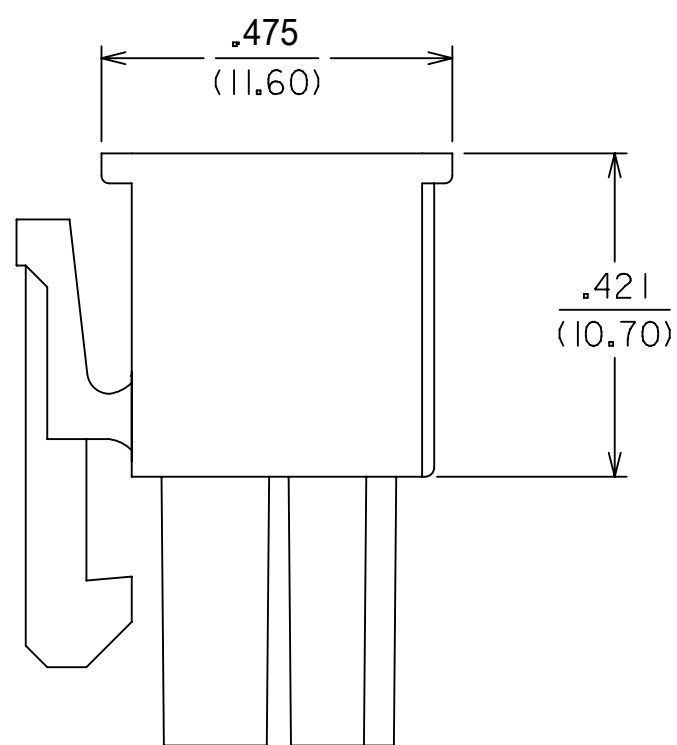
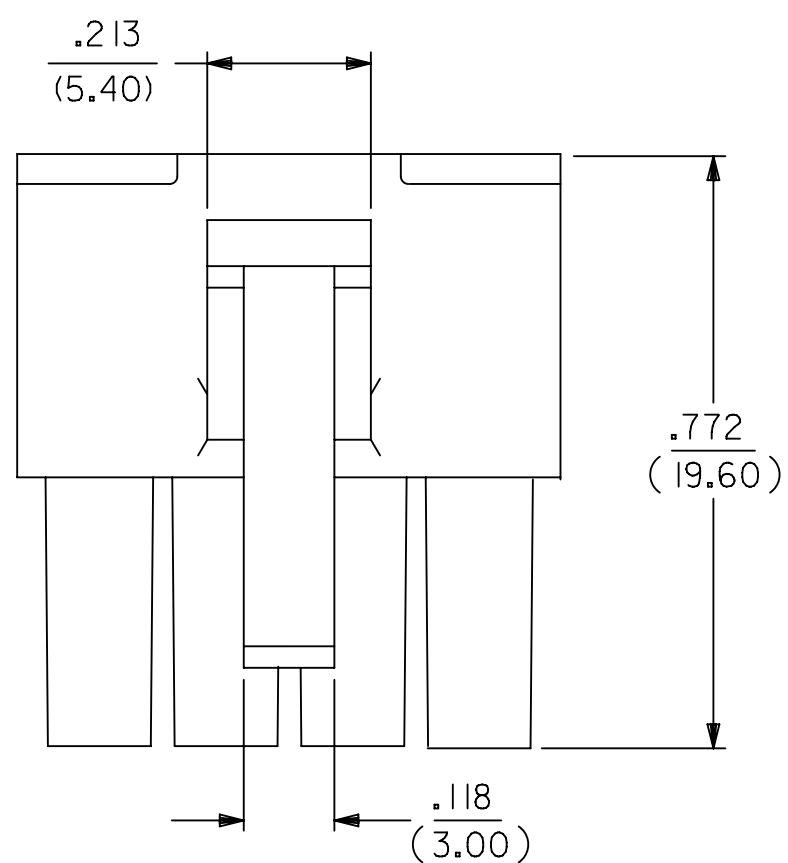

THIS DRAWING CONTAINS INFORMATION THAT IS PROPRIETARY TO MOLEX ELECTRONIC TECHNOLOGIES, LLC AND SHOULD NOT BE USED WITHOUT WRITTEN PERMISSION											
DIMENSION UNITS		SCALE		CURRENT REV DESC:				<b>molex</b>			
mm		NTS									
GENERAL TOLERANCES (UNLESS SPECIFIED)				EC NO: 726879		2022/11/02		8 CKT. RECEPT. HOUSING SPECIAL POLARIZATION MINI-FIT JR. SERIES			
4 PLACES		±		DRWN: JERRYW8		2022/11/07					
3 PLACES		±		CHK'D: XQZHANG		2022/11/07		PRODUCT CUSTOMER DRAWING			
2 PLACES		± 0.25		APPR: XQZHANG		2022/11/07					
1 PLACE		± 0.38		INITIAL REVISION:				DOCUMENT NUMBER			
0 PLACES		±		DRWN: CLS		2003/07/15				SD-45587-001	
ANGULAR TOL		± 5.0 °		APPR: FSMITH		2011/03/01		DOC TYPE			
DRAFT WHERE APPLICABLE MUST REMAIN WITHIN DIMENSIONS				THIRD ANGLE PROJECTION		DRAWING		SERIES		MATERIAL NUMBER	
						C-SIZE		45587		CUSTOMER	
								SEE TABLE		GENERAL MARKET	
										SHEET NUMBER	
										2 OF 2	