

D2FS

Ultra Subminiature Basic Switch

Simple construction and high reliability for long time

- Developed for a few number of operations during a long period of use such as door-detection to avoid sabotage on meters.
- Simple construction with a single-leaf movable spring realizes reasonable cost.
- Self-clinching, right-angled and left-angled PCB terminals are also available.



NEW

RoHS Compliant

Model Number Legend

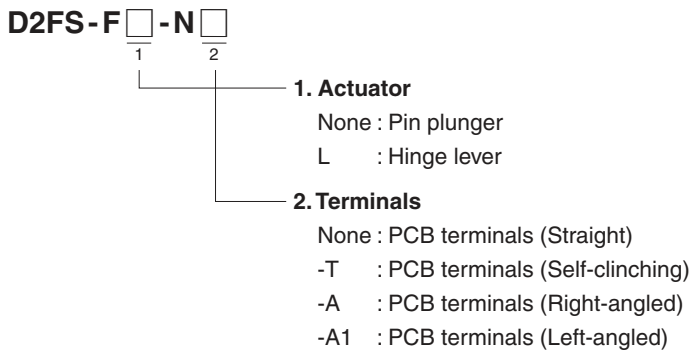

List of Models

Actuator	Terminals	Model
Pin plunger 	PCB terminals (Straight)	D2FS-F-N
	PCB terminals (Self-clinching)	D2FS-F-N-T
	PCB terminals (Right-angled)	D2FS-F-N-A
	PCB terminals (Left-angled)	D2FS-F-N-A1
Hinge lever 	PCB terminals (Straight)	D2FS-FL-N
	PCB terminals (Self-clinching)	D2FS-FL-N-T
	PCB terminals (Right-angled)	D2FS-FL-N-A
	PCB terminals (Left-angled)	D2FS-FL-N-A1

Contact Form

- SPST-NO

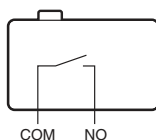

Contact Specifications

Contact	Specification	Crossbar
	Material	Silver
	Gap (standard value)	0.4 mm
Minimum applicable load (see note)		1 mA at 5 VDC

Note: For more information on the minimum applicable load, refer to *Using Micro Loads*.

Ratings

Rated voltage	Resistive load
6 VDC	0.1 A

Note: The rating values apply under the following test conditions.

Ambient temperature: $20 \pm 2^\circ\text{C}$

Ambient humidity: $65 \pm 5\%$

Operating frequency: 20 operations/min

Characteristics

Operating speed		Pin plunger models: 1 mm to 500 mm/s Lever models: 5 mm to 500 mm/s
Operating frequency	Mechanical	Pin plunger models: 200 operations/min max. Lever models: 100 operations/min max.
	Electrical	30 operations/min max.
Insulation resistance		100 M Ω min. (at 500 VDC)
Contact resistance (initial value)		100 m Ω max.
Dielectric strength	Between terminals of same polarity	600 VAC 50/60 Hz 1 min
	Between current carrying metal parts and ground	1,500 VAC 50/60 Hz 1 min
	Between each terminal and non-current carrying metal part	
Vibration resistance	Malfunction *1	10 to 55 Hz, 1.5 mm double amplitude
Shock resistance	Destruction	1,000 m/s ² max.
	Malfunction *1	300 m/s ² max.
Durability *2	Mechanical	100,000 operations min. (at 30 ops./min.)
	Electrical	10,000 operations min. (at 30 ops./min.)
Degree of protection		IP40
Ambient operating temperature		-20 to +70°C (at 60%RH Max.) (with no icing or condensation)
Ambient operation humidity		85%RH max. (for +5 to +35°C)
Weight		Approx. 0.5 g (pin plunger models)

Note: The data given above are initial values.

*1. The values are at Free Position and Total Travel Position values for pin plunger, and Total Travel Position value for lever.

Close or open circuit of the contact is 1 ms max.

*2. For testing conditions, consult your OMRON sales representative.

Terminals (Unit: mm)

● PCB Terminals (Straight)

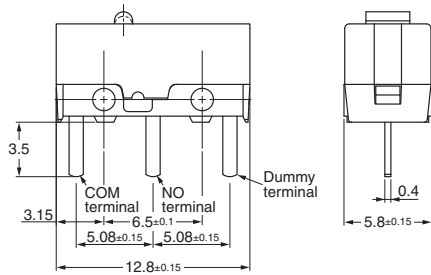

● PCB terminals (Self-clinching)

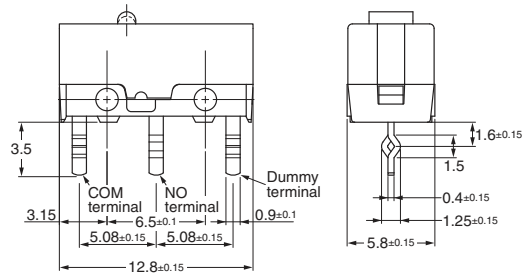

PCB Mounting Dimensions (Reference)

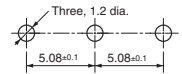

Don't connect the dummy terminal to the circuit.

● PCB Terminals (Right-angled)

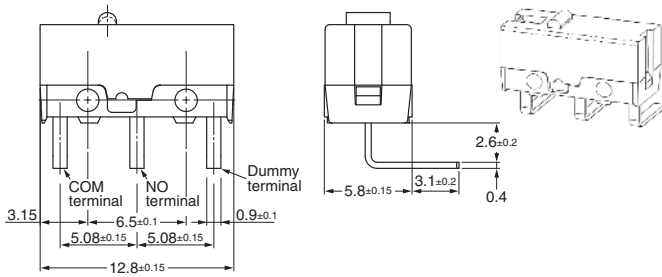

● PCB Terminals (Left-angled)

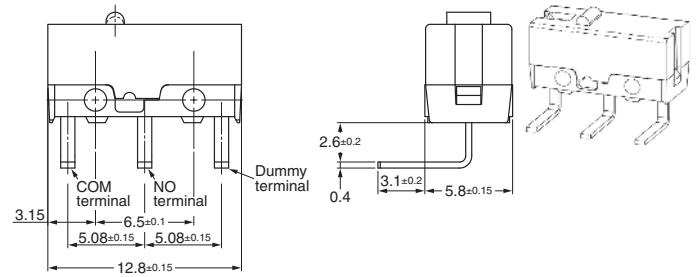

Dimensions (Unit: mm) / Operating Characteristics

The following illustrations and drawings are for D2FS models with PCB terminals (straight). Self-clinching, and right-angled, left angled terminals are omitted from the following drawings. Refer to the above for these terminals.

When ordering, replace \square with the code for the terminal that you need. See the "List of Models" for available combinations of models.

● Pin Plunger Models

D2FS-F-N \square

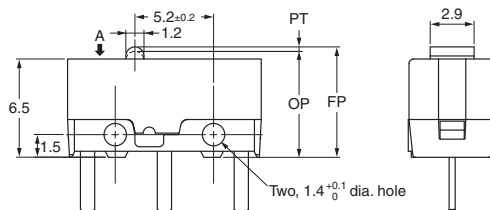

Model	D2FS-F-N \square
OF max.	0.85 N {87 gf}
RF min.	0.05 N {5 gf}
PT max.	0.5 mm
OT min.	0.25 mm
MD max.	0.12 mm
FP max.	7.5 mm
OP	7.0 ± 0.3 mm

● Hinge Lever Models

D2FS-FL-N \square

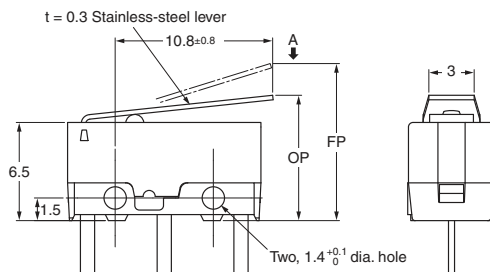
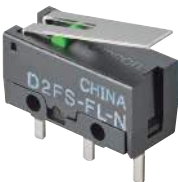

Model	D2FS-FL-N \square
OF max.	0.25 N {25 gf}
RF min.	0.02 N {2 gf}
OT min.	0.55 mm
MD max.	0.5 mm
FP max.	11.5 mm
OP	8.3 ± 1.2 mm

Note: 1. Unless otherwise specified, a tolerance of ± 0.4 mm applies to all dimensions.

2. The operating characteristics are for operation in the A direction (\downarrow).

Precautions

★ Refer to General Information.

Cautions

● Soldering

- When using automatic soldering baths, we recommend soldering at 260°C within 5 seconds. Make sure that the liquid surface of the solder does not flow over the edge of the board.
- When soldering terminals manually, perform soldering within 3 seconds at iron tip temperature not higher than 350°C. Do not apply any external force for at least 1 minute after soldering. When applying solder, keep the solder away from the case of the Switch and do not allow solder or flux to flow into the case.

● Side-actuated (Cam/Dog) Operation

- When using a cam or dog to operate the Switch, factors such as the operating speed, operating frequency, push-button indentation, and material and shape of the cam or dog will affect the durability of the Switch. Confirm performance specifications under actual operating conditions before using the Switch in applications.

Correct Use

● Handling

- When handling the Switch, ensure that uneven pressure or, as shown in the following diagram, pressure in a direction other than the operating direction is not applied to the Actuator, otherwise the Actuator or Switch may be damaged, or durability may be decreased.

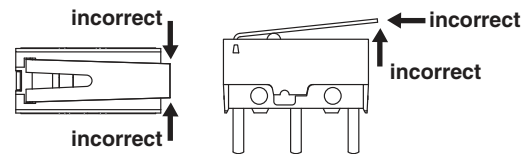

● Using Micro Loads

- Even when using micro load models within the operating range, inrush currents or surges may decrease the life expectancy of the Switch. Therefore, insert a contact protection circuit where necessary.

● Application Environment

- Do not use the Switch in locations that are subject to toxic gas, silicon, excessive dust, excessive dirt, high temperatures, high humidity, sudden temperature changes, water splashes, or oil splashes.

Otherwise, damage resulting by faulty contact of the Switch contacts, corrosion, or other causes, or other functional faults may occur.

• Application examples provided in this document are for reference only. In actual applications, confirm equipment functions and safety before using the product.
 • Consult your OMRON representative before using the product under conditions which are not described in the manual or applying the product to nuclear control systems, railroad systems, aviation systems, vehicles, combustion systems, medical equipment, amusement machines, safety equipment, and other systems or equipment that may have a serious influence on lives and property if used improperly. Make sure that the ratings and performance characteristics of the product provide a margin of safety for the system or equipment, and be sure to provide the system or equipment with double safety mechanisms.

Note: Do not use this document to operate the Unit.