

Thunderbolt® High Speed NPT IGBT

The Thunderbolt HS™ series is based on thin wafer non-punch through (NPT) technology similar to the Thunderbolt® series, but trades higher $V_{CE(ON)}$ for significantly lower turn-on energy E_{off} . The low switching losses enable operation at switching frequencies over 100kHz, approaching power MOSFET performance but lower cost.

An extremely tight parameter distribution combined with a positive $V_{CE(ON)}$ temperature coefficient make it easy to parallel Thunderbolts HS™ IGBT's. Controlled slew rates result in very good noise and oscillation immunity and low EMI. The short circuit duration rating of 10 μ s make these IGBT's suitable for motor drive and inverter applications. Reliability is further enhanced by avalanche energy ruggedness.

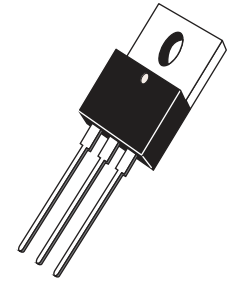

APT30GS60KR(G)

Features

- Fast Switching with low EMI
- Very Low E_{OFF} for Maximum Efficiency
- Short circuit rated
- Low Gate Charge
- Tight parameter distribution
- Easy paralleling
- RoHS Compliant 

Typical Applications

- ZVS Phase Shifted and other Full Bridge
- Half Bridge
- High Power PFC Boost
- Welding
- Induction heating
- High Frequency SMPS



Absolute Maximum Ratings

Symbol	Parameter	Rating	Unit
I_{C1}	Continuous Collector Current $T_C = @ 25^\circ C$	54	A
I_{C2}	Continuous Collector Current $T_C = @ 100^\circ C$	30	
I_{CM}	Pulsed Collector Current ^①	113	
V_{GE}	Gate-Emitter Voltage	$\pm 30V$	V
SSOA	Switching Safe Operating Area	113	
E_{AS}	Single Pulse Avalanche Energy ^②	165	mJ
t_{SC}	Short Circuit Withstand Time ^③	10	μs

Thermal and Mechanical Characteristics

Symbol	Parameter	Min	Typ	Max	Unit
P_D	Total Power Dissipation $T_C = @ 25^\circ C$	-	-	250	W
$R_{\theta JC}$	Junction to Case Thermal Resistance	-	-	0.50	$^\circ C/W$
$R_{\theta CS}$	Case to Sink Thermal Resistance, Flat Greased Surface	-	0.11	-	
T_J, T_{STG}	Operating and Storage Junction Temperature Range	-55	-	150	$^\circ C$
T_L	Soldering Temperature for 10 Seconds (1.6mm from case)	-	-	300	
W_T	Package Weight	-	0.22	-	oz
		-	5.9	-	g
Torque	Mounting Torque, 6-32 M3 Screw	-	-	10	in·lbf
		-	-	1.1	N·m



CAUTION: These Devices are Sensitive to Electrostatic Discharge. Proper Handling Procedures Should be Followed.

Microsemi Website - <http://www.microsemi.com>

Static Characteristics
T_J = 25°C unless otherwise specified
APT30GS60KR(G)

Symbol	Parameter	Test Conditions	Min	Typ	Max	Unit	
V _{BR(CES)}	Collector-Emitter Breakdown Voltage	V _{GE} = 0V, I _C = 250μA	600	-	-	V	
V _{BR(ECS)}	Emitter-Collector Breakdown Voltage	V _{GE} = 0V, I _C = 1A	-	25	-		
ΔV _{BR(CES)/ΔT_J}	Breakdown Voltage Temperature Coeff	Reference to 25°C, I _C = 250μA	-	0.60	-	V/°C	
V _{CE(ON)}	Collector-Emitter On Voltage ^④	V _{GE} = 15V I _C = 30A	T _J = 25°C	-	2.8	3.15	V
			T _J = 125°C	-	3.25	-	
V _{GE(th)}	Gate-Emitter Threshold Voltage	V _{GE} = V _{CE} , I _C = 1mA	3	4	5	mV/°C	
ΔV _{GE(th)/ΔT_J}	Threshold Voltage Temp Coeff		-	6.7	-		
I _{CES}	Zero Gate Voltage Collector Current	V _{CE} = 600V, V _{GE} = 0V	T _J = 25°C	-	-	50	μA
			T _J = 125°C	-	-	1000	
I _{GES}	Gate-Emitter Leakage Current	V _{GE} = ±20V	-	-	±100	nA	

Dynamic Characteristics
T_J = 25°C unless otherwise specified

Symbols	Parameter	Test Conditions	Min	Typ	Max	Unit
g _{fs}	Forward Transconductance	V _{CE} = 50V, I _C = 30A	-	18	-	S
C _{ies}	Input Capacitance	V _{GE} = 0V, V _{CE} = 25V f = 1MHz	-	1600	-	pF
C _{oes}	Output Capacitance		-	140	-	
C _{res}	Reverse Transfer Capacitance		-	90	-	
C _{o(cr)}	Reverse Transfer Capacitance Charge Related ^⑤	V _{GE} = 0V V _{CE} = 0 to 400V	-	130	-	
C _{o(er)}	Reverse Transfer Capacitance Current Related ^⑥		-	95	-	
Q _g	Total Gate Charge	V _{GE} = 0 to 15V I _C = 30A, V _{CE} = 300V	-	145	-	nC
Q _{ge}	Gate-Emitter Charge		-	12	-	
G _{gc}	Gate-Collector Charge		-	65	-	
t _{d(on)}	Turn-On Delay Time	Inductive Switching IGBT and Diode: T _J = 25°C, V _{CC} = 400V, I _C = 30A R _G = 9.1Ω ^⑦ , V _{GG} = 15V	-	16	-	ns
t _r	Rise Time		-	29	-	
t _{d(off)}	Turn-Off Delay Time		-	360	-	
t _f	Fall Time		-	27	-	
E _{on1}	Turn-On Switching Energy ^⑧	Inductive Switching IGBT and Diode: T _J = 125°C, V _{CC} = 400V, I _C = 30A R _G = 9.1Ω ^⑦ , V _{GG} = 15V	-	TBD	-	mJ
E _{on2}	Turn-On Switching Energy ^⑨		-	800	-	
E _{off}	Turn-Off Switching Energy ^⑩		-	570	-	
t _{d(on)}	Turn-On Delay Time	Inductive Switching IGBT and Diode: T _J = 125°C, V _{CC} = 400V, I _C = 30A R _G = 9.1Ω ^⑦ , V _{GG} = 15V	-	16	-	ns
t _r	Rise Time		-	29	-	
t _{d(off)}	Turn-Off Delay Time		-	390	-	
t _f	Fall Time		-	22	-	
E _{on1}	Turn-On Switching Energy ^⑧	Inductive Switching IGBT and Diode: T _J = 125°C, V _{CC} = 400V, I _C = 30A R _G = 9.1Ω ^⑦ , V _{GG} = 15V	-	TBD	-	mJ
E _{on2}	Turn-On Switching Energy ^⑨		-	1185	-	
E _{off}	Turn-Off Switching Energy ^⑩		-	695	-	

TYPICAL PERFORMANCE CURVES

APT30GS60KR(G)

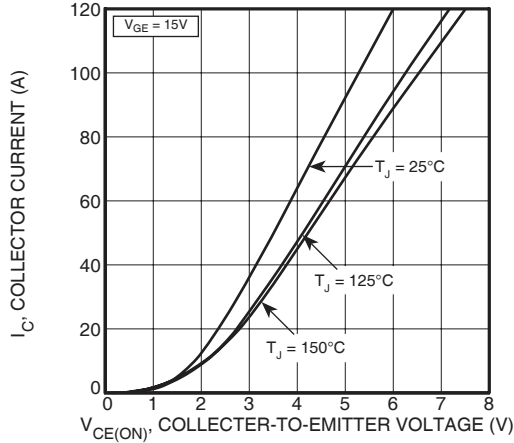

FIGURE 1, Output Characteristics

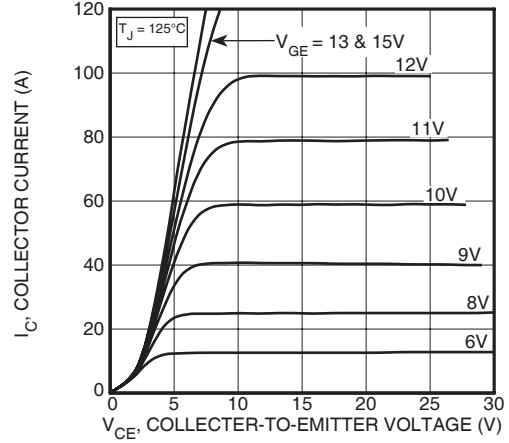

FIGURE 2, Output Characteristics

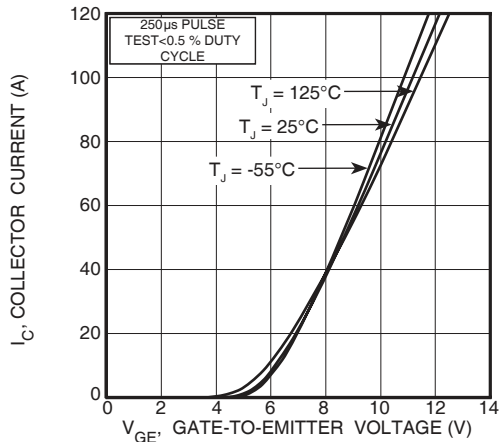

FIGURE 3, Transfer Characteristics

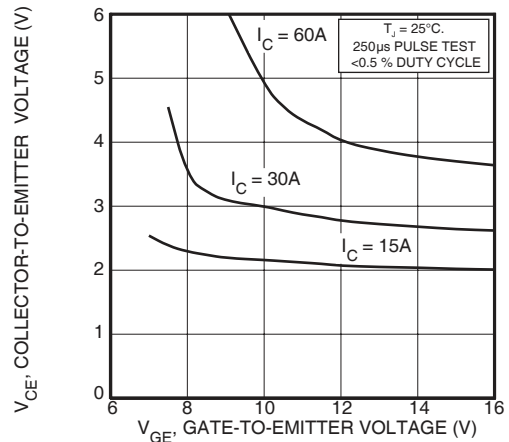

FIGURE 4, On State Voltage vs Gate-to-Emitter Voltage

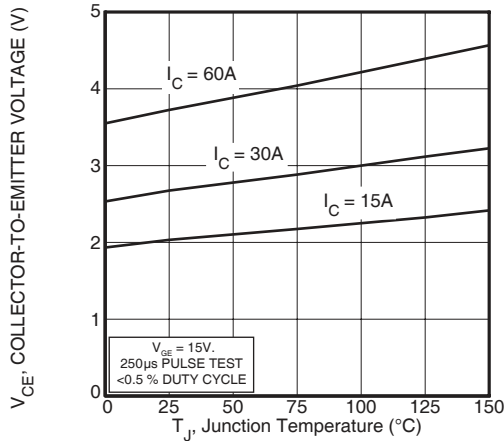

FIGURE 5, On State Voltage vs Junction Temperature

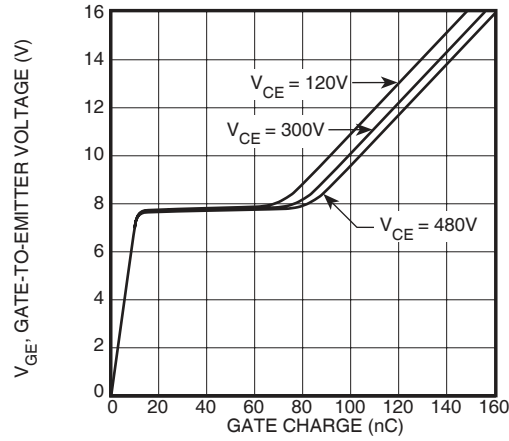

FIGURE 6, Gate Charge

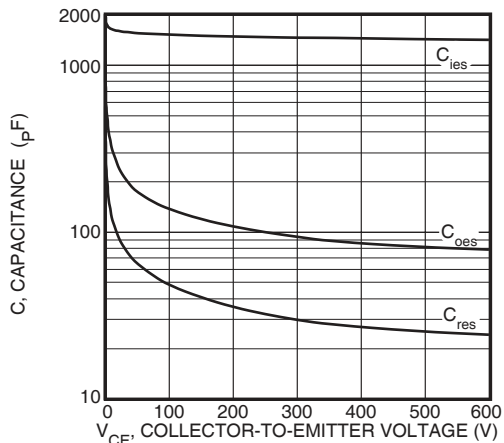

FIGURE 7, Capacitance vs Collector-To-Emitter Voltage

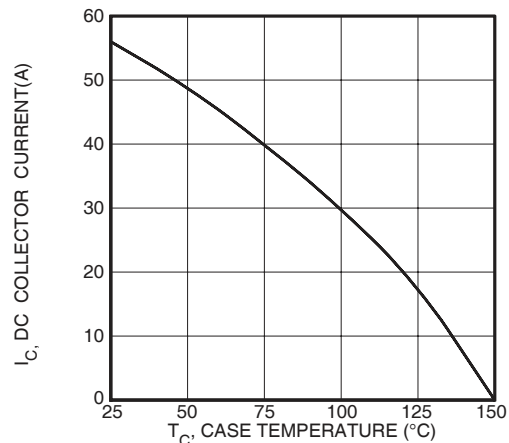

FIGURE 8, DC Collector Current vs Case Temperature

TYPICAL PERFORMANCE CURVES

APT30GS60KR(G)

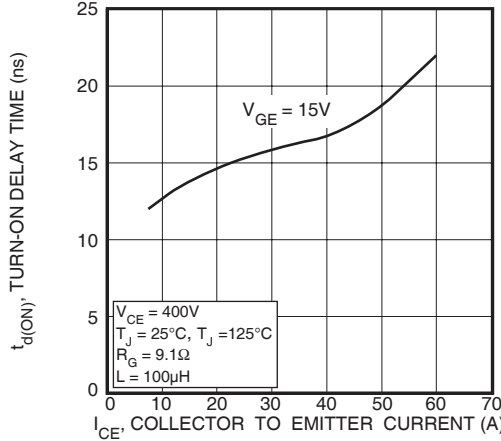

FIGURE 9, Turn-On Delay Time vs Collector Current

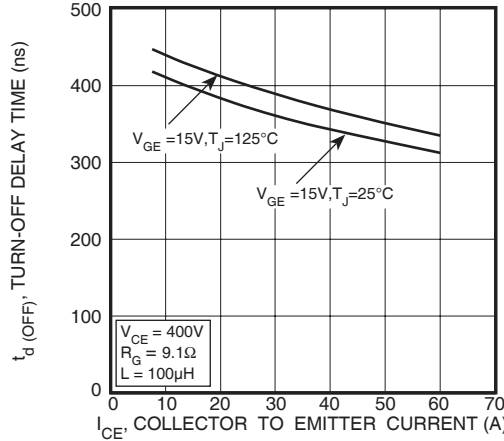

FIGURE 10, Turn-Off Delay Time vs Collector Current

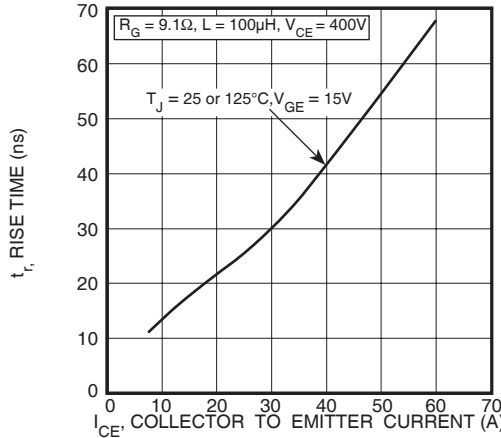

FIGURE 11, Current Rise Time vs Collector Current

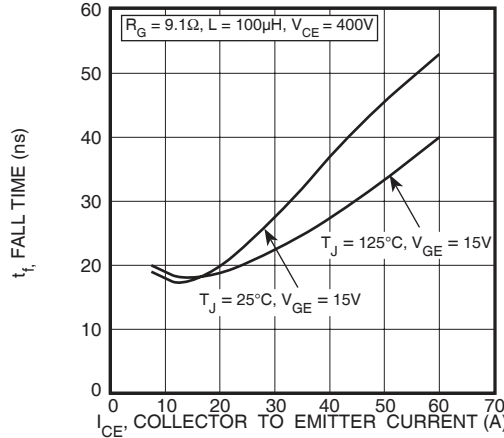

FIGURE 12, Current Fall Time vs Collector Current

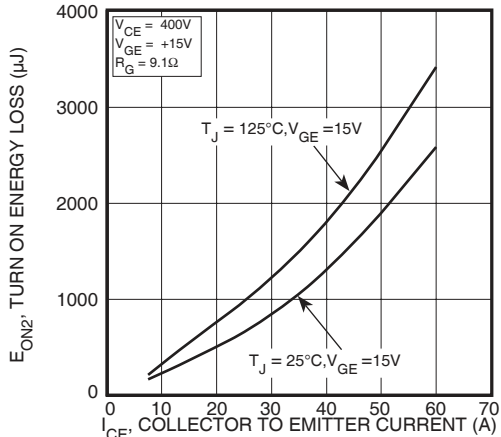

FIGURE 13, Turn-On Energy Loss vs Collector Current

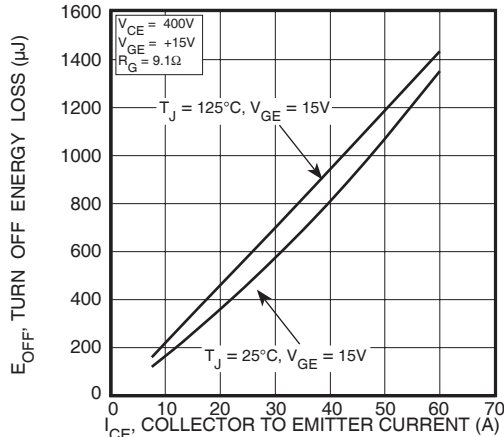

FIGURE 14, Turn Off Energy Loss vs Collector Current

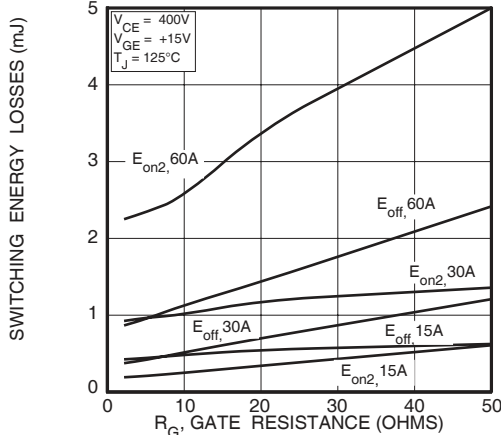

FIGURE 15, Switching Energy Losses vs. Gate Resistance

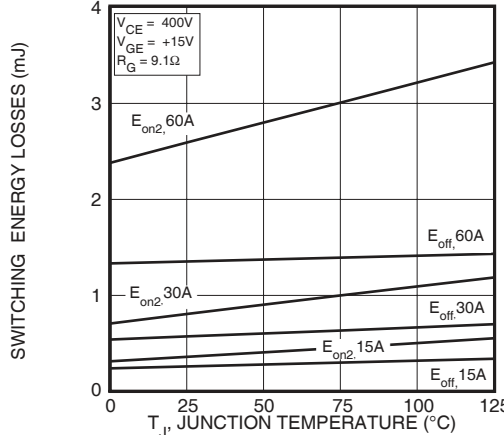

FIGURE 16, Switching Energy Losses vs Junction Temperature

TYPICAL PERFORMANCE CURVES

APT30GS60KR(G)

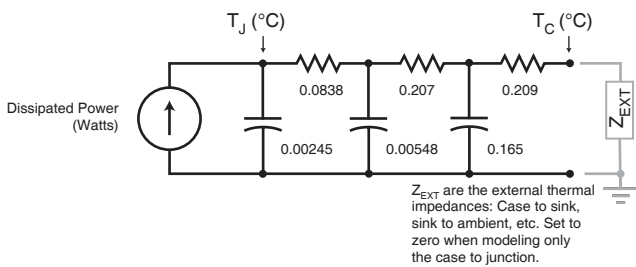
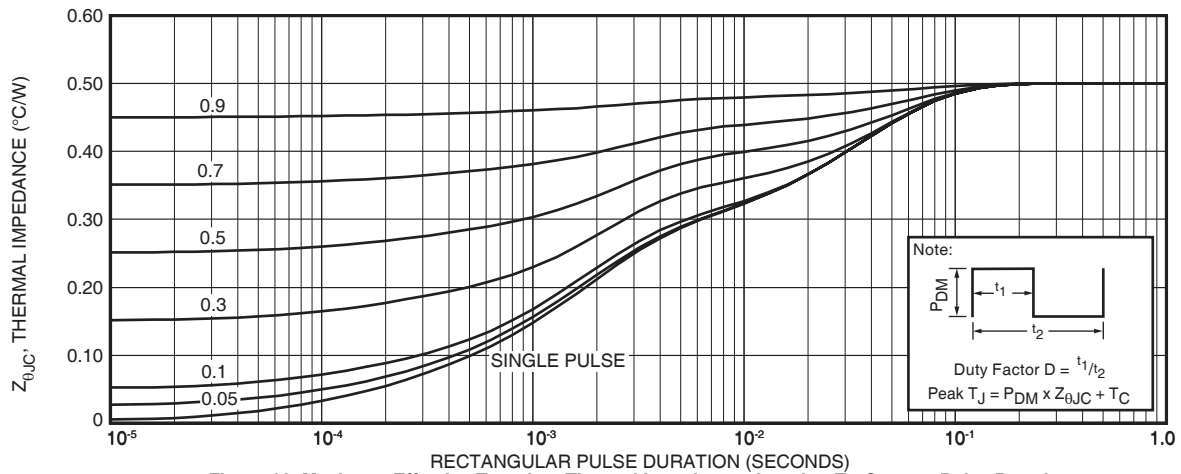
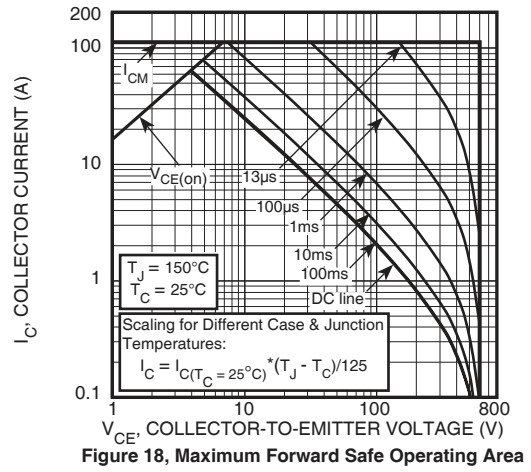
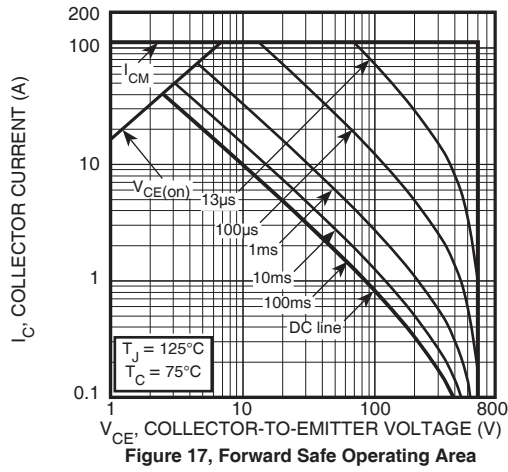

Figure 20, Transient Thermal Impedance Model

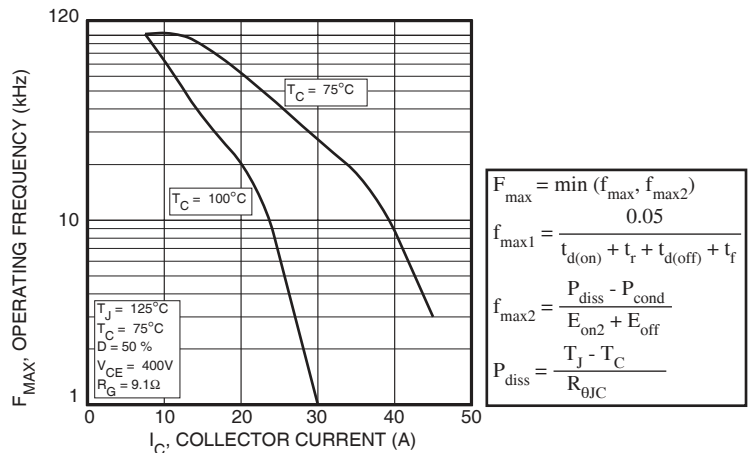

Figure 21, Operating Frequency vs Collector Current

$$f_{max} = \min(f_{max1}, f_{max2})$$

$$f_{max1} = \frac{0.05}{t_{d(on)} + t_r + t_{d(off)} + t_f}$$

$$f_{max2} = \frac{P_{diss} - P_{cond}}{E_{on2} + E_{off}}$$

$$P_{diss} = \frac{T_J - T_C}{R_{\theta JC}}$$

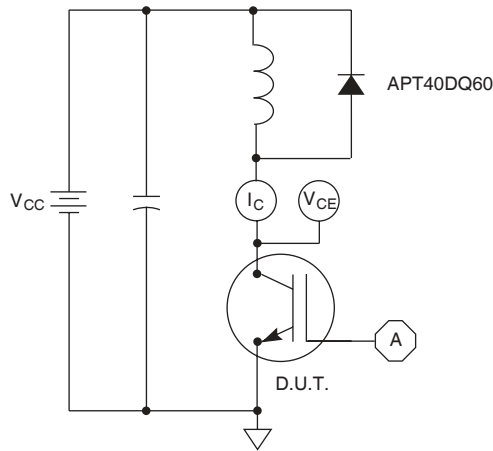

Figure 22, Inductive Switching Test Circuit

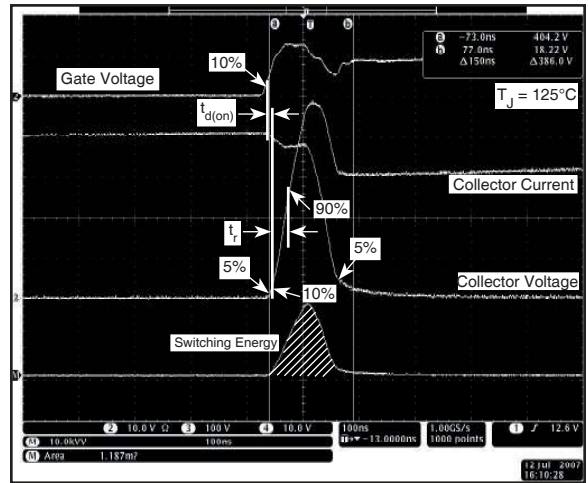

Figure 23, Turn-on Switching Waveforms and Definitions

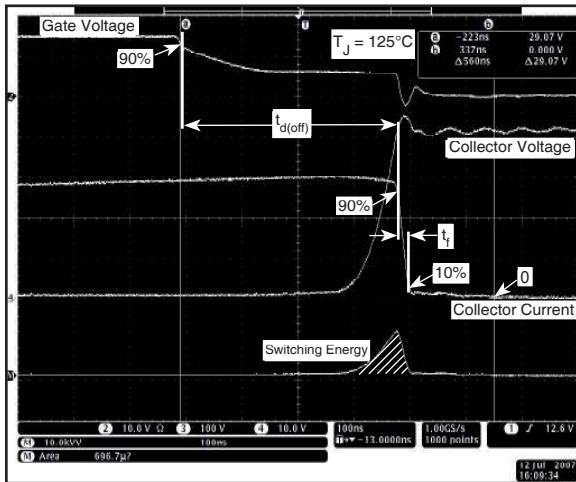

Figure 24, Turn-off Switching Waveforms and Definitions

FOOT NOTE:

- ① Repetitive Rating: Pulse width and case temperature limited by maximum junction temperature.
- ② Starting at $T_J = 25^\circ\text{C}$, $L = 224\mu\text{H}$, $R_G = 25\Omega$, $I_C = 30\text{A}$
- ③ Short circuit time: $V_{GE} = 15\text{V}$, $V_{CC} \leq 600\text{V}$, $T_J \leq 150^\circ\text{C}$
- ④ Pulse test: Pulse width < $380\mu\text{s}$, duty cycle < 2%
- ⑤ $C_{o(cr)}$ is defined as a fixed capacitance with the same stored charge as C_{oes} with $V_{CE} = 67\%$ of $V_{(BR)CES}$.
- ⑥ $C_{o(er)}$ is defined as a fixed capacitance with the same stored energy as C_{oes} with $V_{CE} = 67\%$ of $V_{(BR)CES}$. To calculate $C_{o(er)}$ for any value of V_{CE} less than $V_{(BR)CES}$, use this equation: $C_{o(er)} = -1.40\text{E-}7/V_{DS}^2 + 1.47\text{E-}8/V_{DS} + 5.95\text{E-}11$.
- ⑦ R_G is external gate resistance, not including internal gate resistance or gate driver impedance (MIC4452).
- ⑧ E_{on1} is the inductive turn-on energy of the IGBT only, without the effect of a commutating diode reverse recovery current adding to the IGBT turn-on switching loss. It is measured by clamping the inductance with a Silicon Carbide Schottky diode.
- ⑨ E_{on2} is the inductive turn-on energy that includes a commutating diode reverse recovery current in the IGBT turn-on energy.
- ⑩ E_{off} is the clamped inductive turn-off energy measured in accordance with JEDEC standard JESD24-1.

Microsemi reserves the right to change, without notice, the specifications and information contained herein.

TO-220 K Package Outline

(e1) SAC: Tin, Silver, Copper

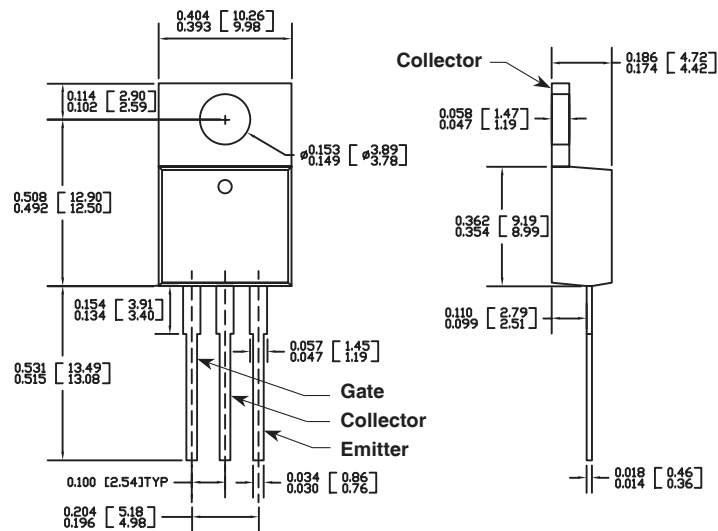

Dimensions in Inches and (Millimeters)