

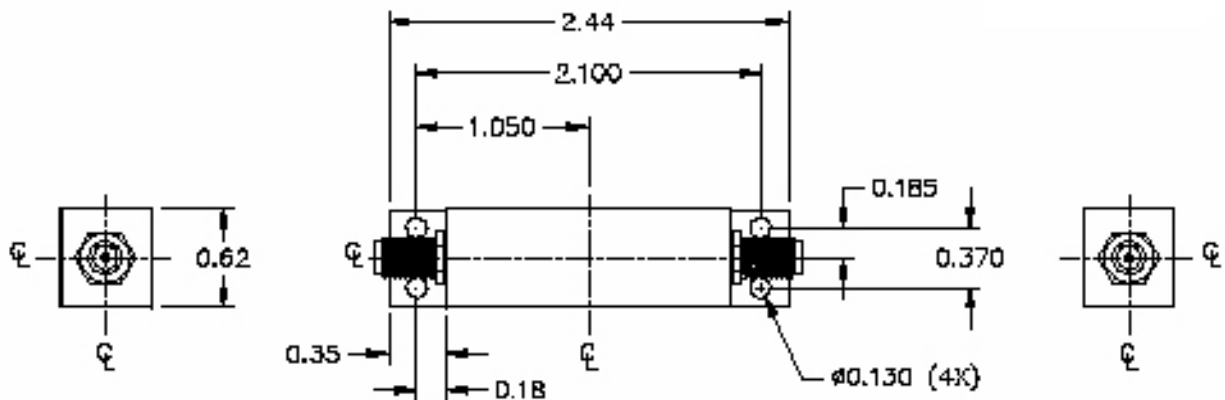

169.140 MHz Crystal Filter

Part Number: AM169.140CR219

Center Frequency (Fo)	169.140 MHz
3 dB Band Width:	15 KHz Min
Insertion Loss:	6 dB Max
Pass Band Return Loss:	15 dB Min
Pass Band Ripple:	.5 dB Max
±50 KHz	20 dB Min
Input Power	0 dBm Max
Impedance:	50 Ohms
Operating Temperature:	-30 to +60°C
Workmanship	IPC-610 Class 2
RoHS COMPLIANT	NO



SMA CONNECTOR (2X)
(REF DA-093)

