



MC68060
MC68LC060
MC68EC060

MICROPROCESSORS
USER'S MANUAL



Introduction	1
Signal Description	2
Integer Unit	3
Memory Management Unit	4
Caches	5
Floating-Point Unit	6
Bus Operation	7
Exception Processing	8
IEEE 1149.1 Test (JTAG) and Debug Pipe Control Modes	9
Instruction Execution Timing	10
Applications	11
Electrical and Thermal Characteristics	12
Ordering Information and Mechanical Data	13
MC68LC060	A
MC68EC060	B
MC68060 Software Package	C
M68060 Instructions	D
Index	I

- 1** Introduction
- 2** Signal Description
- 3** Integer Unit
- 4** Memory Management Unit
- 5** Caches
- 6** Floating-Point Unit
- 7** Bus Operation
- 8** Exception Processing
- 9** IEEE 1149.1 Test (JTAG) and Debug Pipe Control Modes
- 10** Instruction Execution Timing
- 11** Applications
- 12** Electrical and Thermal Characteristics
- 13** Ordering Information and Mechanical Data
- A** MC68LC060
- B** MC68EC060
- C** MC68060 Software Package
- D** M68060 Instructions
- I** Index



MOTOROLA

M68060 User's Manual

**Including the
MC68060,
MC68LC060,
and
MC68EC060**

Motorola reserves the right to make changes without further notice to any products herein. Motorola makes no warranty, representation or guarantee regarding the suitability of its products for any particular purpose, nor does Motorola assume any liability arising out of the application or use of any product or circuit, and specifically disclaims any and all liability, including without limitation consequential or incidental damages. "Typical" parameters can and do vary in different applications. All operating parameters, including "Typicals" must be validated for each customer application by customer's technical experts. Motorola does not convey any license under its patent rights nor the rights of others. Motorola products are not designed, intended, or authorized for use as components in systems intended for surgical implant into the body, or other applications intended to support or sustain life, or for any other application in which the failure of the Motorola product could create a situation where personal injury or death may occur. Should Buyer purchase or use Motorola products for any such unintended or unauthorized application, Buyer shall indemnify and hold Motorola and its officers, employees, subsidiaries, affiliates, and distributors harmless against all claims, costs, damages, and expenses, and reasonable attorney fees arising out of, directly or indirectly, any claim of personal injury or death associated with such unintended or unauthorized use, even if such claim alleges that Motorola was negligent regarding the design or manufacture of the part. Motorola and  are registered trademarks of Motorola, Inc. Motorola, Inc. is an Equal Opportunity/Affirmative Action Employer.

68K FAX-IT

Documentation Comments

FAX 512-891-8593—Documentation Comments Only

The Motorola High-End Technical Publications Department provides a fax number for you to submit any questions or comments about this document or how to order other documents. We welcome your suggestions for improving our documentation. Please do not fax technical questions.

Please provide the part number and revision number (located in upper right-hand corner of the cover) and the title of the document. When referring to items in the manual, please reference by the page number, paragraph number, figure number, table number, and line number if needed.

When sending a fax, please provide your name, company, fax number, and phone number including area code.

Applications and Technical Information

For questions or comments pertaining to technical information, questions, and applications, please contact one of the following sales offices nearest you.

— Sales Offices —

Field Applications Engineering Available Through All Sales Offices

UNITED STATES

ALABAMA , Huntsville	(205) 464-6800
ARIZONA , Tempe	(602) 897-5056
CALIFORNIA , Agoura Hills	(818) 706-1929
CALIFORNIA , Los Angeles	(310) 417-8848
CALIFORNIA , Irvine	(714) 753-7360
CALIFORNIA , Roseville	(916) 922-7152
CALIFORNIA , San Diego	(619) 541-2163
CALIFORNIA , Sunnyvale	(408) 749-0510
COLORADO , Colorado Springs	(719) 599-7497
COLORADO , Denver	(303) 337-3434
CONNECTICUT , Wallingford	(203) 949-4100
FLORIDA , Maitland	(407) 628-2636
FLORIDA , Pompano Beach/ Fort Lauderdale	(305) 486-9776
FLORIDA , Clearwater	(813) 538-7750
GEORGIA , Atlanta	(404) 729-7100
IDAHO , Boise	(208) 323-9413
ILLINOIS , Chicago/Hoffman Estates	(708) 490-9500
INDIANA , Fort Wayne	(219) 436-5818
INDIANA , Indianapolis	(317) 571-0400
INDIANA , Kokomo	(317) 457-6634
IOWA , Cedar Rapids	(319) 373-1328
KANSAS , Kansas City/Mission	(913) 451-8555
MARYLAND , Columbia	(410) 381-1570
MASSACHUSETTS , Marlborough	(508) 481-8100
MASSACHUSETTS , Woburn	(617) 932-9700
MICHIGAN , Detroit	(313) 347-6800
MINNESOTA , Minnetonka	(612) 932-1500
MISSOURI , St. Louis	(314) 275-7380
NEW JERSEY , Fairfield	(201) 808-2400
NEW YORK , Fairport	(716) 425-4000
NEW YORK , Hauppauge	(516) 361-7000
NEW YORK , Poughkeepsie/Fishkill	(914) 473-8102
NORTH CAROLINA , Raleigh	(919) 870-4355
OHIO , Cleveland	(216) 349-3100
OHIO , Columbus/Worthington	(614) 431-8492
OHIO , Dayton	(513) 495-6800
OKLAHOMA , Tulsa	(800) 544-9496
OREGON , Portland	(503) 641-3681
PENNSYLVANIA , Colmar	(215) 997-1020
PENNSYLVANIA , Philadelphia/Horsham	(215) 957-4100
TENNESSEE , Knoxville	(615) 690-5593
TEXAS , Austin	(512) 873-2000
TEXAS , Houston	(800) 343-2692
TEXAS , Plano	(214) 516-5100
VIRGINIA , Richmond	(804) 285-2100
WASHINGTON , Bellevue	(206) 454-4160
WASHINGTON , Seattle Access	(206) 622-9960
WISCONSIN , Milwaukee/Brookfield	(414) 792-0122

CANADA

BRITISH COLUMBIA , Vancouver	(604) 293-7605
ONTARIO , Toronto	(416) 497-8181
ONTARIO , Ottawa	(613) 226-3491
QUEBEC , Montreal	(514) 731-6881

INTERNATIONAL

AUSTRALIA , Melbourne	(61-3)887-0711
AUSTRALIA , Sydney	(61-2)906-3855
BRAZIL , Sao Paulo	55(11)815-4200
CHINA , Beijing	86 505-2180
FINLAND , Helsinki	358-0-35161191
FINLAND , Car Phone	358(49)211501
FRANCE , Paris/Varves	33(1)40 355 900

GERMANY , Langenhagen/ Hanover	49(511)789911
GERMANY , Munich	49 89 92103-0
GERMANY , Nuremberg	49 911 64-3044
GERMANY , Sindelfingen	49 7031 69 910
GERMANY , Wiesbaden	49 611 761921
HONG KONG , Kwai Fong	852-4808333
HONG KONG , Tai Po	852-6668333
INDIA , Bangalore	(91-812)627094
ISRAEL , Tel Aviv	972(3)753-8222
ITALY , Milan	39(2)82201
JAPAN , Aizu	81(241)272231
JAPAN , Atsugi	81(0462)23-0761
JAPAN , Kurmagaya	81(0485)26-2600
JAPAN , Kyushu	81(092)771-4212
JAPAN , Mito	81(0292)26-2340
JAPAN , Nagoya	81(052)232-1621
JAPAN , Osaka	81(06)305-1801
JAPAN , Sendai	81(22)268-4333
JAPAN , Tachikawa	81(0425)23-6700
JAPAN , Tokyo	81(03)3440-3311
JAPAN , Yokohama	81(045)472-2751
KOREA , Pusan	82(51)4635-035
KOREA , Seoul	82(2)554-5188
MALAYSIA , Penang	60(4)374514
MEXICO , Mexico City	52(5)282-2864
MEXICO , Guadalajara	52(36)21-8977
MEXICO , Marketing	52(36)21-9023
MEXICO , Customer Service	52(36)669-9160
NETHERLANDS , Best	(31)49988 612 11
PUERTO RICO , San Juan	(809)793-2170
SINGAPORE	(65)2945438
SPAIN , Madrid	34(1)457-8204
SPAIN , or	34(1)457-8254
SWEDEN , Soina	46(8)734-8800
SWITZERLAND , Geneva	41(22)7991111
SWITZERLAND , Zurich	41(1)730 4074
TAIWAN , Taipei	886(2)717-7089
THAILAND , Bangkok	(66-2)254-4910
UNITED KINGDOM , Aylesbury	44(296)395-252

FULL LINE REPRESENTATIVES

COLORADO , Grand Junction	
Cheryl Lee Whitely	(303) 243-9658
KANSAS , Wichita	
Melinda Shores/Kelly Greiving	(316) 838 0190
NEVADA , Reno	
Galena Technology Group	(702) 746 0642
NEW MEXICO , Albuquerque	
S&S Technologies, Inc.	(505) 298-7177
UTAH , Salt Lake City	
Utah Component Sales, Inc.	(801) 561-5099
WASHINGTON , Spokane	
Doug Kenley	(509) 924-2322
ARGENTINA , Buenos Aires	
Argonics, S.A.	(541) 343-1787

HYBRID COMPONENTS RESELLERS

Elmo Semiconductor	(818) 768-7400
Minco Technology Labs Inc.	(512) 834-2022
Semi Dice Inc.	(310) 594-4631

PREFACE

The complete documentation package for the MC68060, MC68LC060, and MC68EC060 (collectively called M68060) consists of the M68060UM/AD, *M68060 User's Manual*, and the M68000PM/AD, *M68000 Family Programmer's Reference Manual*. The *M68060 User's Manual* describes the capabilities, operation, and programming of the M68060 superscalar 32-bit microprocessors. The *M68000 Family Programmer's Reference Manual* contains the complete instruction set for the M68000 family.

The introduction of this manual includes general information concerning the MC68060 and summarizes the differences among the M68060 family devices. Additionally, appendices provide detailed information on how these M68060 derivatives operate differently from the MC68060.

When reading this manual, disregard information concerning the floating-point unit in reference to the MC68LC060, and disregard information concerning the floating-point unit and memory management unit in reference to the MC68EC060.

The organization of this manual is as follows:

Section 1	Introduction
Section 2	Signal Description
Section 3	Integer Unit
Section 4	Memory Management Unit
Section 5	Caches
Section 6	Floating-Point Unit
Section 7	Bus Operation
Section 8	Exception Processing
Section 9	IEEE 1149.1 Test (JTAG) and Debug Pipe Control Modes
Section 10	Instruction Timings
Section 11	Applications
Section 12	Electrical and Thermal Characteristics
Section 13	Ordering Information and Mechanical Data
Appendix A	MC68LC060
Appendix B	MC68EC060
Appendix C	MC68060 Software Package
Appendix D	M68060 Instructions

MC68060 ACRONYM LIST

AGU—address generation unit
ALU—arithmetic logic unit
ATC—address translation cache
BUSCR—bus control register
CACR—cache control register
CCR—condition code register
CM—cache mode
CPU—central processing unit
DFC—destination function code
DTTx—data transparent translation register
DRAM—dynamic random access memory
FPIAR—floating-point instruction address register
FPCR—floating-point control register
FPSP—floating-point software package
FPSR—floating-point status register
FPU—floating-point unit
FP7–FP0—floating-point data registers 7–0
FSLW—fault status long word
IEE—integer execute unit
IFP—instruction fetch pipeline
IFU—instruction fetch unit
IPU—instruction pipe unit
ISP—interrupt stack pointer
ITTR—instruction transparent translation register
IU—integer unit
JTAG—Joint Test Action Group
MMU—memory management unit

MC68060 Acronym List

MMUSR—memory management unit status register
M68060SP—M68060 software package
NaNs—not-a-numbers
NOP—no operation
OEP—operand execution pipeline
OPU—operand pipe unit
PC—program counter
PCR—processor configuration register
PGI—page index field
PI—pointer index field
PLL—phase-locked loop
pOEP—primary operand execution pipeline
RI—root index field
SFC—source function code
SNAN—signaling not-a-number
sOEP—secondary operand execution pipeline
SP—stack pointer
SR—status register
SRP—supervisor root pointer register
SSP—supervisor stack pointer
TAP—test access port
TCR—translation control register
TTL—transistor-transistor logic
TTR—transparent translation register
UPA—user page attribute
URP—user root pointer register
USP—user stack pointer
VBR—vector base register
VLSI—very large-scale integration

TABLE OF CONTENTS

Section 1 Introduction

1.1	Differences Among M68060 Family Members.....	1-3
1.1.1	MC68LC060.....	1-3
1.1.2	MC68EC060.....	1-3
1.1.2.1	Address Translation Differences.....	1-3
1.1.2.2	Instruction Differences.....	1-3
1.2	Features.....	1-4
1.3	Architecture.....	1-4
1.4	Processor Overview.....	1-5
1.4.1	Functional Blocks.....	1-5
1.4.2	Integer Unit.....	1-7
1.4.2.1	Instruction Fetch Unit.....	1-7
1.4.2.2	Integer Unit.....	1-8
1.4.2.3	Floating-Point Unit.....	1-8
1.4.2.4	Memory Units.....	1-9
1.4.2.5	Address Translation Caches.....	1-9
1.4.2.6	Instruction and Data Caches.....	1-9
1.4.2.6.1	Cache Organization.....	1-10
1.4.2.6.2	Cache Coherency.....	1-10
1.4.3	Bus Controller.....	1-10
1.5	Processing States.....	1-10
1.6	Programming Model.....	1-11
1.7	Data Format Summary.....	1-14
1.8	Addressing Capabilities Summary.....	1-14
1.9	Instruction Set Overview.....	1-15
1.10	Notational Conventions.....	1-21

Section 2 Signal Description

2.1	Address and Control Signals.....	2-3
2.1.1	Address Bus (A31–A0).....	2-3
2.1.2	Cycle Long-Word Address (\overline{CLA}).....	2-4
2.2	Data Bus (D31–D0).....	2-4
2.3	Transfer Attribute Signals.....	2-4
2.3.1	Transfer Cycle Type (TT1, TT0).....	2-4
2.3.2	Transfer Cycle Modifier (TM2–TM0).....	2-4
2.3.3	Transfer Line Number (TLN1, TLN0).....	2-5
2.3.4	User-Programmable Page Attributes (UPA1, UPA0).....	2-5
2.3.5	Read/Write (R/W).....	2-6

Table of Contents

2.3.6	Transfer Size (SIZ1, SIZ0).....	2-6
2.3.7	Bus Lock ($\overline{\text{LOCK}}$).....	2-6
2.3.8	Bus Lock End ($\overline{\text{LOCKE}}$).....	2-6
2.3.9	Cache Inhibit Out ($\overline{\text{CIOUT}}$).....	2-7
2.3.10	Byte Select Lines ($\overline{\text{BS3}}\text{--}\overline{\text{BS0}}$).....	2-7
2.4	Master Transfer Control Signals.....	2-7
2.4.1	Transfer Start ($\overline{\text{TS}}$).....	2-8
2.4.2	Transfer in Progress ($\overline{\text{TIP}}$).....	2-8
2.4.3	Starting Termination Acknowledge Signal Sampling ($\overline{\text{SAS}}$).....	2-8
2.5	Slave Transfer Control Signals.....	2-8
2.5.1	Transfer Acknowledge ($\overline{\text{TA}}$).....	2-8
2.5.2	Transfer Retry Acknowledge ($\overline{\text{TRA}}$).....	2-8
2.5.3	Transfer Error Acknowledge (TEA).....	2-9
2.5.4	Transfer Burst Inhibit ($\overline{\text{TBI}}$).....	2-9
2.5.5	Transfer Cache Inhibit ($\overline{\text{TCI}}$).....	2-9
2.6	Snoop Control ($\overline{\text{SNOOP}}$).....	2-9
2.7	Arbitration Signals.....	2-10
2.7.1	Bus Request ($\overline{\text{BR}}$).....	2-10
2.7.2	Bus Grant ($\overline{\text{BG}}$).....	2-10
2.7.3	Bus Grant Relinquish Control ($\overline{\text{BGR}}$).....	2-10
2.7.4	Bus Tenure Termination ($\overline{\text{BTT}}$).....	2-10
2.7.5	Bus Busy ($\overline{\text{BB}}$).....	2-11
2.8	Processor Control Signals.....	2-11
2.8.1	Cache Disable ($\overline{\text{CDIS}}$).....	2-11
2.8.2	MMU Disable ($\overline{\text{MDIS}}$).....	2-12
2.8.3	Reset In ($\overline{\text{RSTI}}$).....	2-12
2.8.4	Reset Out ($\overline{\text{RSTO}}$).....	2-12
2.9	Interrupt Control Signals.....	2-12
2.9.1	Interrupt Priority Level ($\overline{\text{IPL2}}\text{--}\overline{\text{IPL0}}$).....	2-12
2.9.2	Interrupt Pending Status ($\overline{\text{IPEND}}$).....	2-12
2.9.3	Autovector ($\overline{\text{AVEC}}$).....	2-13
2.10	Status and Clock Signals.....	2-13
2.10.1	Processor Status (PST4–PST0).....	2-13
2.10.2	MC68060 Processor Clock (CLK).....	2-14
2.10.3	Clock Enable (CLKEN).....	2-14
2.11	Test Signals.....	2-15
2.11.1	JTAG Enable ($\overline{\text{JTAG}}$).....	2-15
2.11.2	Test Clock (TCK).....	2-15
2.11.3	Test Mode Select (TMS).....	2-15
2.11.4	Test Data In (TDI).....	2-16
2.11.5	Test Data Out (TDO).....	2-16
2.11.6	Test Reset (TRST).....	2-16
2.12	Thermal Sensing Pins (THERM1, THERM0).....	2-16
2.13	Power Supply Connections.....	2-16
2.14	Signal Summary.....	2-16

Section 3 Integer Unit

3.1	Integer Unit Execution Pipelines	3-1
3.2	Integer Unit Register Description	3-2
3.2.1	Integer Unit User Programming Model	3-2
3.2.1.1	Data Registers (D7–D0)	3-2
3.2.1.2	Address Registers (A6–A0)	3-2
3.2.1.3	User Stack Pointer (A7)	3-2
3.2.1.4	Program Counter	3-3
3.2.1.5	Condition Code Register	3-3
3.2.2	Integer Unit Supervisor Programming Model	3-3
3.2.2.1	Supervisor Stack Pointer	3-4
3.2.2.2	Status Register	3-4
3.2.2.3	Vector Base Register	3-4
3.2.2.4	Alternate Function Code Registers	3-5
3.2.2.5	Processor Configuration Register	3-5

Section 4 Memory Management Unit

4.1	Memory Management Programming Model	4-3
4.1.1	User and Supervisor Root Pointer Registers	4-3
4.1.2	Translation Control Register	4-4
4.1.3	Transparent Translation Registers	4-6
4.2	Logical Address Translation	4-7
4.2.1	Translation Tables	4-7
4.2.2	Descriptors	4-12
4.2.2.1	Table Descriptors	4-12
4.2.2.2	Page Descriptors	4-12
4.2.2.3	Descriptor Field Definitions	4-13
4.2.3	Translation Table Example	4-15
4.2.4	Variations in Translation Table Structure	4-16
4.2.4.1	Indirect Action	4-16
4.2.4.2	Table Sharing Between Tasks	4-17
4.2.4.3	Table Paging	4-17
4.2.4.4	Dynamically Allocated Tables	4-17
4.2.5	Table Search Accesses	4-19
4.2.6	Address Translation Protection	4-20
4.2.6.1	Supervisor and User Translation Tables	4-21
4.2.6.2	Supervisor Only	4-22
4.2.6.3	Write Protect	4-22
4.3	Address Translation Caches	4-24
4.4	Transparent Translation	4-27
4.5	Address Translation Summary	4-28
4.6	$\overline{\text{RSTI}}$ and $\overline{\text{MDIS}}$ Effect on the MMU	4-28
4.6.1	Effect of $\overline{\text{RSTI}}$ on the MMUs	4-28

Table of Contents

4.6.2	Effect of $\overline{\text{MDIS}}$ on Address Translation	4-30
4.7	MMU Instructions	4-30
4.7.1	MOVEC	4-30
4.7.2	PFLUSH	4-30
4.7.3	PLPA	4-30

Section 5 Caches

5.1	Cache Operation	5-1
5.2	Cache Control Register	5-5
5.3	Cache Management	5-6
5.4	Caching Modes	5-7
5.4.1	Cachable Accesses	5-7
5.4.1.1	Writethrough Mode	5-7
5.4.1.2	Copyback Mode	5-8
5.4.2	Cache-Inhibited Accesses	5-8
5.4.3	Special Accesses	5-9
5.5	Cache Protocol	5-9
5.5.1	Read Miss	5-9
5.5.2	Write Miss	5-9
5.5.3	Read Hit	5-9
5.5.4	Write Hit	5-10
5.6	Cache Coherency	5-10
5.7	Memory Accesses for Cache Maintenance	5-11
5.7.1	Cache Filling	5-11
5.7.2	Cache Pushes	5-13
5.8	Push Buffer	5-13
5.9	Store Buffer	5-13
5.10	Push Buffer and Store Buffer Bus Operation	5-14
5.11	Branch Cache	5-14
5.12	Cache Operation Summary	5-15
5.12.1	Instruction Cache	5-15
5.12.2	Data Cache	5-16

Section 6 Floating-Point Unit

6.1	Floating-Point User Programming Model	6-2
6.1.1	Floating-Point Data Registers (FP7–FP0)	6-3
6.1.2	Floating-Point Control Register (FPCR)	6-3
6.1.2.1	Exception Enable Byte	6-3
6.1.2.2	Mode Control Byte	6-3
6.1.3	Floating-Point Status Register (FPSR)	6-4
6.1.3.1	Floating-Point Condition Code Byte	6-5
6.1.3.2	Quotient Byte	6-5
6.1.3.3	Exception Status Byte	6-5

6.1.3.4	Accrued Exception Byte	6-6
6.1.4	Floating-Point Instruction Address Register (FPIAR)	6-7
6.2	Floating-Point Data Formats and Data Types	6-7
6.3	Computational Accuracy	6-11
6.3.1	Intermediate Result	6-12
6.3.2	Rounding the Result	6-13
6.4	Postprocessing Operation	6-15
6.4.1	Underflow, Round, and Overflow	6-15
6.4.2	Conditional Testing	6-16
6.5	Floating-Point Exceptions	6-19
6.5.1	Unimplemented Floating-Point Instructions	6-19
6.5.2	Unsupported Floating-Point Data Types	6-21
6.5.3	Unimplemented Effective Address Exception	6-22
6.6	Floating-Point Arithmetic Exceptions	6-22
6.6.1	Branch/Set on Unordered (BSUN)	6-24
6.6.1.1	Trap Disabled Results (FPCR BSUN Bit Cleared)	6-24
6.6.1.2	Trap Enabled Results (FPCR BSUN Bit Set)	6-24
6.6.2	Signaling Not-a-Number (SNAN)	6-25
6.6.2.1	Trap Disabled Results (FPCR SNAN Bit Cleared)	6-25
6.6.2.2	Trap Enabled Results (FPCR SNAN Bit Set)	6-26
6.6.3	Operand Error	6-26
6.6.3.1	Trap Disabled Results (FPCR OPERR Bit Cleared)	6-27
6.6.3.2	Trap Enabled Results (FPCR OPERR Bit Set)	6-27
6.6.4	Overflow	6-28
6.6.4.1	Trap Disabled Results (FPCR OVFL Bit Cleared)	6-29
6.6.4.2	Trap Enabled Results (FPCR OVFL Bit Set)	6-29
6.6.5	Underflow	6-30
6.6.5.1	Trap Disabled Results (FPCR UNFL Bit Cleared)	6-31
6.6.5.2	Trap Enabled Results (FPCR UNFL Bit Set)	6-31
6.6.6	Divide-by-Zero	6-32
6.6.6.1	Trap Disabled Results (FPCR DZ Bit Cleared)	6-33
6.6.6.2	Trap Enabled Results (FPCR DZ Bit Set)	6-33
6.6.7	Inexact Result	6-33
6.6.7.1	Trap Disabled Results (FPCR INEX1 Bit and INEX2 Bit Cleared)	6-34
6.6.7.2	Trap Enabled Results (Either FPCR INEX1 Bit or INEX2 Bit Set)	6-34
6.7	Floating-Point State Frames	6-35

Section 7 Bus Operation

7.1	Bus Characteristics	7-1
7.2	Full-, Half-, and Quarter-Speed Bus Operation and BCLK	7-3
7.3	Acknowledge Termination Ignore State Capability	7-4
7.4	Bus Control Register	7-4
7.5	Data Transfer Mechanism	7-5
7.6	Misaligned Operands	7-9

Table of Contents

7.7	Processor Data Transfers	7-12
7.7.1	Byte, Word, and Long-Word Read Transfer Cycles	7-12
7.7.2	Line Read Transfer	7-15
7.7.3	Byte, Word, and Long-Word Write Cycles	7-20
7.7.4	Line Write Cycles	7-25
7.7.5	Locked Read-Modify-Write Cycles	7-28
7.7.6	Emulating CAS2 and CAS Misaligned	7-31
7.7.7	Using CLA to Increment A3 and A2	7-32
7.8	Acknowledge Cycles	7-32
7.8.1	Interrupt Acknowledge Cycles	7-32
7.8.1.1	Interrupt Acknowledge Cycle (Terminated Normally)	7-35
7.8.1.2	Autovector Interrupt Acknowledge Cycle	7-35
7.8.1.3	Spurious Interrupt Acknowledge Cycle	7-35
7.8.2	Breakpoint Acknowledge Cycle	7-36
7.8.2.1	LPSTOP Broadcast Cycle	7-38
7.9	Bus Exception Control Cycles	7-46
7.9.1	Bus Errors	7-46
7.9.2	Retry Operation	7-48
7.9.3	Double Bus Fault	7-51
7.10	Bus Synchronization	7-52
7.11	Bus Arbitration	7-52
7.11.1	MC68040-Arbitration Protocol (BB Protocol)	7-53
7.11.2	MC68060-Arbitration Protocol (BTT Protocol)	7-58
7.11.3	External Arbiter Considerations	7-65
7.12	Bus Snooping Operation	7-68
7.13	Reset Operation	7-71
7.14	Special Modes of Operation	7-74
7.14.1	Acknowledge Termination Ignore State Capability	7-74
7.14.2	Acknowledge Termination Protocol	7-76
7.14.3	Extra Data Write Hold Time Mode	7-76

Section 8 Exception Processing

8.1	Exception Processing Overview	8-1
8.2	Integer Unit Exceptions	8-4
8.2.1	Access Error Exception	8-5
8.2.2	Address Error Exception	8-7
8.2.3	Instruction Trap Exception	8-7
8.2.4	Illegal Instruction and Unimplemented Instruction Exceptions	8-8
8.2.5	Privilege Violation Exception	8-10
8.2.6	Trace Exception	8-10
8.2.7	Format Error Exception	8-11
8.2.8	Breakpoint Instruction Exception	8-11
8.2.9	Interrupt Exception	8-12
8.2.10	Reset Exception	8-14

8.3	Exception Priorities	8-17
8.4	Return from Exceptions	8-19
8.4.1	Four-Word Stack Frame (Format \$0)	8-19
8.4.2	Six-Word Stack Frame (Format \$2)	8-20
8.4.3	Floating-Point Post-Instruction Stack Frame (Format \$3)	8-20
8.4.4	Eight-Word Stack Frame (Format \$4)	8-21
8.4.4.1	Program Counter (PC)	8-21
8.4.4.2	Fault Address	8-22
8.4.4.3	Fault Status Long Word (FSLW)	8-22
8.4.5	Recovering from an Access Error	8-25
8.4.6	Bus Errors and Pending Memory Writes	8-27
8.4.7	Branch Prediction Error	8-29

Section 9

IEEE 1149.1 Test (JTAG) and Debug Pipe Control Modes

9.1	IEEE 1149.1 Test Access Port (Normal JTAG) Mode	9-1
9.1.1	Overview	9-2
9.1.2	JTAG Instruction Shift Register	9-3
9.1.2.1	EXTEST	9-4
9.1.2.2	LPSAMPLE	9-5
9.1.2.3	Private Instructions	9-5
9.1.2.4	SAMPLE/PRELOAD	9-5
9.1.2.5	IDCODE	9-5
9.1.2.6	CLAMP	9-6
9.1.2.7	HIGHZ	9-6
9.1.2.8	BYPASS	9-6
9.1.3	JTAG Test Data Registers	9-7
9.1.3.1	Idcode Register	9-7
9.1.3.2	Boundary Scan Register	9-7
9.1.3.3	Bypass Register	9-15
9.1.4	Restrictions	9-15
9.1.5	Disabling the IEEE 1149.1 Standard Operation	9-15
9.1.6	Motorola MC68060 BSDL Description	9-17
9.2	Debug Pipe Control Mode	9-24
9.2.1	Debug Command Interface	9-25
9.2.2	Debug Pipe Control Mode Commands	9-27
9.2.3	Emulator Mode	9-31
9.3	Switching between JTAG and Debug Pipe Control Modes of Operation	9-33

Section 10

Instruction Execution Timing

10.1	Superscalar Operand Execution Pipelines	10-1
10.1.1	Dispatch Test 1: sOEP Opword and Required Extension Words Are Valid	10-2
10.1.2	Dispatch Test 2: Instruction Classification	10-2

Table of Contents

10.1.3	Dispatch Test 3: Allowable Effective Addressing Mode in the sOEP	10-8
10.1.4	Dispatch Test 4: Allowable Operand Data Memory Reference	10-8
10.1.5	Dispatch Test 5: No Register Conflicts on sOEP.AGU Resources	10-8
10.1.6	Dispatch Test 6: No Register Conflicts on sOEP.IEE Resources	10-9
10.2	Timing Assumptions	10-10
10.3	Cache and ATC Performance Degradation Times	10-12
10.3.1	Instruction ATC Miss	10-12
10.3.2	Data ATC Miss	10-13
10.3.3	Instruction Cache Miss	10-13
10.3.4	Data Cache Miss	10-13
10.4	Effective Address Calculation Times	10-14
10.5	Move Instruction Execution Times	10-14
10.6	Standard Instruction Execution Times	10-16
10.7	Immediate Instruction Execution Times	10-17
10.8	Single-Operand Instruction Execution Times	10-18
10.9	Shift/Rotate Execution Times	10-19
10.10	Bit Manipulation and Bit Field Execution Times	10-19
10.11	Branch Instruction Execution Times	10-21
10.12	LEA, PEA, and MOVEM Execution Times	10-22
10.13	Multiprecision Instruction Execution Times	10-22
10.14	Status Register, MOVES, and Miscellaneous Instruction Execution Times	10-22
10.15	FPU Instruction Execution Times	10-24
10.16	Exception Processing Times	10-26

Section 11

Applications Information

11.1	Guidelines for Porting Software to the MC68060	11-1
11.1.1	User Code	11-1
11.1.2	Supervisor Code	11-1
11.1.2.1	Initialization Code (Reset Exception Handler)	11-2
11.1.2.1.1	Processor Configuration Register (PCR) (MOVEC of PCR)	11-2
11.1.2.1.2	Default Transparent Translation Register (MOVEC of TCR)	11-2
11.1.2.1.3	MC68060 Software Package (M68060SP)	11-2
11.1.2.1.4	Cache Control Register (CACR) (MOVEC of CACR)	11-3
11.1.2.1.5	Resource Checking (Access Error Handler)	11-3
11.1.2.2	Virtual Memory Software	11-3
11.1.2.2.1	Translation Control Register (MOVEC of TCR)	11-3
11.1.2.2.2	Descriptors in Cacheable Copyback Pages Prohibited	11-4
11.1.2.2.3	Page and Descriptor Faults (Access Error Handler)	11-4
11.1.2.2.4	PTEST, MOVEC of MMUSR, and PLPA	11-4
11.1.2.3	Context Switch Interrupt Handlers	11-5
11.1.2.4	Trace Handlers	11-5
11.1.2.5	I/O Device Driver Software	11-5
11.1.3	Precise Vs. Imprecise Exception Mode	11-6

11.1.4	Other Considerations	11-6
11.2	Using an MC68060 in an Existing MC68040 System	11-6
11.2.1	Power Considerations	11-6
11.2.1.1	DC to DC Voltage Conversion	11-6
11.2.1.1.1	Linear Voltage Regulator Solution	11-7
11.2.1.1.2	Switching Regulator Solution	11-7
11.2.1.2	Input Signals During Power-Up Requirement	11-11
11.2.2	Output Hold Time Differences	11-11
11.2.3	Bus Arbitration	11-13
11.2.4	Snooping	11-13
11.2.5	Special Modes	11-13
11.2.6	Clocking	11-14
11.2.7	PSTx Encoding	11-14
11.2.8	Miscellaneous Pullup Resistors	11-15
11.3	Example DRAM Access	11-15
11.4	Thermal Management	11-17
11.5	Support Devices	11-20

Section 12

Electrical and Thermal Characteristics

12.1	Maximum Ratings	12-1
12.2	Thermal Characteristics	12-1
12.3	Power Dissipation	12-1
12.4	DC Electrical Specifications (Vcc = 3.3 Vdc ± 5%)	12-2
12.5	Clock Input Specifications (Vcc = 3.3 Vdc ± 5%)	12-3
12.6	Output AC Timing Specifications (Vcc = 3.3 Vdc ± 5%)	12-4
12.7	Input AC Timing Specifications (Vcc = 3.3 Vdc ± 5%)	12-6

Section 13

Ordering Information and Mechanical Data

13.1	Ordering Information	13-1
13.2	Pin Assignments	13-1
13.2.1	MC68060, MC68LC060, and MC68EC060 Pin Grid Array (RC Suffix)	13-2
13.2.2	MC68060, MC68LC060, and MC68EC060 Quad Flat Pack (FE Suffix) ...	13-3
13.3	Mechanical Data	13-4

Appendix A MC68LC060

Appendix B MC68EC060

B.1	Address Translation Differences	B-1
B.2	Instruction Differences	B-1

Table of Contents

Appendix C MC68060 Software Package

C.1	Module Format.....	C-2
C.2	Unimplemented Integer Instructions.....	C-4
C.2.1	Integer Emulation Results.....	C-5
C.2.2	Module 1: Unimplemented Integer Instruction Exception (MC68060ISP).....	C-5
C.2.2.1	Unimplemented Integer Instruction Exception Module Entry Points.....	C-6
C.2.2.2	Unimplemented Integer Instruction Exception Module Call-Outs.....	C-6
C.2.2.3	CAS Misaligned Address and CAS2 Emulation-Related Call-Outs and Entry Points.....	C-6
C.2.3	Module 2: Unimplemented Integer Instruction Library (MC68060ILSP).....	C-9
C.3	Floating-Point Emulation Package (MC68060FPSP).....	C-11
C.3.1	Floating-Point Emulation Results.....	C-13
C.3.2	Module 3: Full Floating-Point Kernel.....	C-14
C.3.2.1	Full Floating-Point Kernel Module Entry Points.....	C-14
C.3.2.2	Full Floating-Point Kernel Module Call-Outs.....	C-14
C.3.2.2.1	The F-Line Exception Call-Outs.....	C-14
C.3.2.2.2	System-Supplied Floating-Point Arithmetic Exception Handler Call-Outs.....	C-15
C.3.2.2.3	Exception-Related Call-Outs.....	C-15
C.3.2.2.4	Exit Point Call-Outs.....	C-15
C.3.2.3	Bypassing Module-Supplied Floating-Point Arithmetic Handlers.....	C-15
C.3.2.3.1	Overflow/Underflow.....	C-16
C.3.2.3.2	Signalling Not-A-Number, Operand Error.....	C-17
C.3.2.3.3	Inexact Exception.....	C-18
C.3.2.3.4	Divide-by-Zero Exception.....	C-19
C.3.2.3.5	Branch/Set on Unordered Exception.....	C-19
C.3.2.4	Exceptions During Emulation.....	C-20
C.3.2.4.1	Trap-Disabled Operation.....	C-20
C.3.2.4.2	Trap-Enabled Operation.....	C-21
C.3.3	Module 4: Partial Floating-Point Kernel.....	C-21
C.3.4	Module 5: Floating-Point Library (M68060FPLSP).....	C-22
C.4	Operating System Dependencies.....	C-23
C.4.1	Instruction and Data Fetches.....	C-23
C.4.2	Instructions Not Recommended.....	C-26
C.5	Installation Notes.....	C-27
C.5.1	Installing the Library Modules.....	C-27
C.5.2	Installing the Kernel Modules.....	C-27
C.5.3	Release Notes and Module Offset Assignments.....	C-28
C.5.4	AESOP Electronic Bulletin Board.....	C-29

Appendix D MC68060 Instructions

LIST OF ILLUSTRATIONS

1-1	MC68060 Block Diagram	1-6
1-2	Programming Model	1-12
2-1	Functional Signal Groups	2-3
3-1	MC68060 Integer Unit Pipeline	3-1
3-2	Integer Unit User Programming Model	3-2
3-3	Integer Unit Supervisor Programming Model	3-3
3-4	Status Register	3-4
3-5	Processor Configuration Register	3-5
4-1	Memory Management Unit	4-2
4-2	Memory Management Programming Model	4-3
4-3	URP and SRP Register Formats	4-3
4-4	Translation Control Register Format	4-4
4-5	Transparent Translation Register Format	4-6
4-6	Translation Table Structure	4-8
4-7	Logical Address Format	4-8
4-8	Detailed Flowchart of Table Search Operation	4-10
4-9	Detailed Flowchart of Descriptor Fetch Operation	4-11
4-10	Table Descriptor Formats	4-12
4-11	Page Descriptor Formats	4-12
4-12	Example Translation Table	4-15
4-13	Translation Table Using Indirect Descriptors	4-16
4-14	Translation Table Using Shared Tables	4-18
4-15	Translation Table with Nonresident Tables	4-19
4-16	Translation Table Structure for Two Tasks	4-21
4-17	Logical Address Map with Shared Supervisor and User Address Spaces	4-22
4-18	Translation Table Using S-Bit and W-Bit To Set Protection	4-23
4-19	ATC Organization	4-24
4-20	ATC Entry and Tag Fields	4-25
4-21	Address Translation Flowchart	4-29
5-1	MC68060 Instruction and Data Caches	5-2
5-2	Instruction Cache Line Format	5-2
5-3	Data Cache Line Format	5-2
5-4	Caching Operation	5-3
5-5	Cache Control Register	5-5
5-6	Instruction Cache Line State Diagram	5-16
5-7	Data Cache Line State Diagrams	5-18
6-1	Floating-Point Unit Block Diagram	6-2
6-2	Floating-Point User Programming Model	6-3
6-3	Floating-Point Control Register Format	6-4

List of Illustrations

6-4	Floating-Point Condition Code (FPSR)	6-5
6-5	Floating-Point Quotient Byte (FPSR)	6-5
6-6	Floating-Point Exception Status Byte (FPSR)	6-6
6-7	Floating-Point Accrued Exception Byte (FPSR)	6-6
6-8	Intermediate Result Format	6-12
6-9	Rounding Algorithm Flowchart	6-14
6-10	Floating-Point State Frame	6-35
6-11	Status Word Contents	6-36
7-1	Signal Relationships to Clocks	7-2
7-2	Full-Speed Clock	7-2
7-3	Half-Speed Clock	7-2
7-4	Quarter-Speed Clock	7-3
7-5	Bus Control Register Format	7-4
7-6	Internal Operand Representation	7-5
7-7	Data Multiplexing	7-6
7-8	Byte Select Signal Generation and PAL Equation	7-8
7-9	Example of a Misaligned Long-Word Transfer	7-10
7-10	Example of Misaligned Word Transfer	7-10
7-11	Misaligned Long-Word Read Bus Cycle Timing	7-11
7-12	Byte, Word, and Long-Word Read Cycle Flowchart	7-13
7-13	Byte, Word, and Long-Word Read Bus Cycle Timing	7-14
7-14	Line Read Cycle Flowchart	7-17
7-15	Line Read Transfer Timing	7-18
7-16	Burst-Inhibited Line Read Cycle Flowchart	7-20
7-17	Burst-Inhibited Line Read Bus Cycle Timing	7-21
7-18	Byte, Word, and Long-Word Write Transfer Flowchart	7-22
7-19	Long-Word Write Bus Cycle Timing	7-23
7-20	Line Write Cycle Flowchart	7-26
7-21	Line Write Burst-Inhibited Cycle Flowchart	7-27
7-22	Line Write Bus Cycle Timing	7-28
7-23	Locked Bus Cycle for TAS Instruction Timing	7-30
7-24	Using \overline{CLA} in a High-Speed DRAM Design	7-33
7-25	Interrupt Pending Procedure	7-33
7-26	Assertion of \overline{IPEND}	7-34
7-27	Interrupt Acknowledge Cycle Flowchart	7-36
7-28	Interrupt Acknowledge Bus Cycle Timing	7-37
7-29	Autovector Interrupt Acknowledge Bus Cycle Timing	7-38
7-30	Breakpoint Interrupt Acknowledge Cycle Flowchart	7-39
7-31	Breakpoint Interrupt Acknowledge Bus Cycle Timing	7-40
7-32	LPSTOP Broadcast Cycle Flowchart	7-41
7-33	LPSTOP Broadcast Bus Cycle Timing, BG Negated	7-42
7-34	LPSTOP Broadcast Bus Cycle Timing, BG Asserted	7-43
7-35	Exiting LPSTOP Mode Flowchart	7-44
7-36	Exiting LPSTOP Mode Timing Diagram	7-45
7-37	Word Write Access Bus Cycle Terminated with \overline{TEA} Timing	7-48

7-38	Line Read Access Bus Cycle Terminated with \overline{TEA} Timing	7-49
7-39	Retry Read Bus Cycle Timing	7-50
7-40	Line Write Retry Bus Cycle Timing	7-51
7-41	MC68040-Arbitration Protocol State Diagram	7-57
7-42	MC68060-Arbitration Protocol State Diagram	7-64
7-43	Processor Bus Request Timing	7-67
7-44	Arbitration During Relinquish and Retry Timing	7-68
7-45	Implicit Bus Ownership Arbitration Timing	7-69
7-46	Effect of \overline{BGR} on Locked Sequences	7-70
7-47	Snooped Bus Cycle	7-71
7-48	Initial Power-On Reset Timing	7-72
7-49	Normal Reset Timing	7-73
7-50	Data Bus Usage During Reset	7-74
7-51	Acknowledge Termination Ignore State Example	7-75
7-52	Extra Data Write Hold Example	7-77
8-1	General Exception Processing Flowchart	8-2
8-2	General Form of Exception Stack Frame	8-3
8-3	Interrupt Recognition Examples	8-13
8-4	Interrupt Exception Processing Flowchart	8-15
8-5	Reset Exception Processing Flowchart	8-16
8-6	Fault Status Long-Word Format	8-22
9-1	JTAG Test Logic Block Diagram	9-3
9-2	JTAG Idcode Register Format	9-7
9-3	Output Pin Cell (O.Pin)	9-8
9-4	Observe-Only Input Pin Cell (I.Obs)	9-8
9-5	Input Pin Cell (I.Pin)	9-9
9-6	Output Control Cell (IO.Ctl)	9-9
9-7	General Arrangement of Bidirectional Pin Cells	9-10
9-8	JTAG Bypass Register	9-15
9-9	Circuit Disabling IEEE Standard 1149.1	9-16
9-10	Debug Command Interface Schematic	9-25
9-11	Interface Timing	9-26
9-12	Transition from JTAG to Debug Mode Timing Diagram	9-34
9-13	Transition from Debug to JTAG Mode Timing Diagram	9-35
11-1	Linear Voltage Regulator Solution	11-7
11-2	LTC1147 Voltage Regulator Solution	11-8
11-3	LTC1148 Voltage Regulator Solution	11-9
11-4	MAX767 Voltage Regulator Solution	11-10
11-5	MC68040 Address Hold Time	11-11
11-6	MC68060 Address Hold Time	11-12
11-7	MC68060 Address Hold Time Fix	11-12
11-8	Simple CLK Generation	11-14
11-9	Generic CLK Generation	11-14
11-10	MC68040 BCLK to \overline{CLKEN} Relationship	11-15
11-11	DRAM Timing Analysis	11-15

List of Illustrations

12-12	Clock Input Timing Diagram.....	12-3
12-13	Drive Levels and Test Points for AC Specifications.....	12-7
12-14	Reset Configuration Timing.....	12-8
12-15	Read/Write Timing.....	12-9
12-16	Bus Arbitration Timing.....	12-10
12-17	Bus Arbitration Timing (Continued).....	12-11
12-18	CL \bar{A} Timing.....	12-12
12-19	Snoop Timing.....	12-13
12-20	Other Signals Timing.....	12-14
13-1	PGA Package Dimensions (RC Suffix).....	13-4
13-2	QFP Package Dimensions (FE Suffix).....	13-5
C-1	Call-Out Dispatch Table Example.....	C-2
C-2	Example Pseudo-Assembly File.....	C-3
C-3	Module Call-In, Call-Out Example.....	C-4
C-4	CAS and CAS2 Call-Outs and Entry Points.....	C-9
C-5	C-Code Representation of Integer Library Routines.....	C-10
C-6	MUL Instruction Call Example.....	C-11
C-7	CMP2 Instruction Call Example.....	C-11
C-8	SNAN/OPERR Exception Handler Pseudo-Code.....	C-18
C-9	Disabled vs. Enabled Exception Actions.....	C-20
C-10	_mem_read Pseudo-Code.....	C-23
C-11	Register Usage of {i,d}mem_{read,write}_{b,w,l}.....	C-25
C-12	Vector Table and M68060SP Relationship.....	C-28

LIST OF TABLES

1-1	Data Formats.....	1-14
1-2	Effective Addressing Modes.....	1-15
1-3	Instruction Set Summary.....	1-16
1-4	Notational Conventions.....	1-21
2-1	Signal Index.....	2-1
2-2	Transfer-Type Encoding.....	2-4
2-3	Normal and MOVE16 Access TMx Encoding.....	2-5
2-4	Alternate Access TMx Encoding.....	2-5
2-5	SIZx Encoding.....	2-6
2-6	Data Bus Byte Select Signals.....	2-7
2-7	PSTx Encoding.....	2-14
2-8	Signal Summary.....	2-17
4-1	Updating U-Bit and M-Bit for Page Descriptors.....	4-20
4-2	SFC and DFC Values.....	4-20
5-1	TLNx Encoding.....	5-11
5-2	Instruction Cache Line State Transitions.....	5-15
5-3	Data Cache Line State Transitions.....	5-18
6-1	RND Encoding.....	6-4
6-2	PREC Encoding.....	6-4
6-3	MC68060 FPU Data Formats and Data Types.....	6-7
6-4	Single-Precision Real Format Summary.....	6-8
6-5	Double-Precision Real Format Summary.....	6-9
6-6	Extended-Precision Real Format Summary.....	6-10
6-7	Packed Decimal Real Format Summary.....	6-11
6-8	Floating-Point Condition Code Encoding.....	6-16
6-9	Floating-Point Conditional Tests.....	6-18
6-10	Floating-Point Exception Vectors.....	6-19
6-11	Unimplemented Instructions.....	6-20
6-12	Possible Operand Errors Exceptions.....	6-27
6-13	Overflow Rounding Mode Values.....	6-29
6-14	Underflow Rounding Mode Values.....	6-31
6-15	Possible Divide-by-Zero Exceptions.....	6-33
6-16	Rounding Mode Values.....	6-34
7-1	Data Bus Requirements for Read and Write Cycles.....	7-7
7-2	Summary of Access Types vs. Bus Signal Encoding.....	7-9
7-3	Memory Alignment Influence on Noncacheable and Writethrough Bus Cycles.....	7-12
7-4	Interrupt Acknowledge Termination Summary.....	7-34
7-5	Termination Result Summary.....	7-46
7-6	MC68040-Arbitration Protocol Transition Conditions.....	7-55

List of Tables

7-7	MC68040-Arbitration Protocol State Description	7-56
7-8	MC68060-Arbitration Protocol State Transition Conditions	7-62
7-9	MC68060-Arbitration Protocol State Description	7-63
7-10	Special Mode vs. \overline{IPLx} Signals	7-74
8-1	Exception Vector Assignments	8-4
8-2	Interrupt Levels and Mask Values	8-12
8-3	Exception Priority Groups	8-17
9-1	JTAG States	9-2
9-2	JTAG Instructions	9-4
9-3	Boundary Scan Bit Definitions	9-10
9-4	Debug Command Interface Pins	9-25
9-5	Command Summary	9-28
10-1	Superscalar OEP Dispatch Test Algorithm	10-4
10-2	MC68060 Superscalar Classification of M680x0 Integer Instructions	10-4
10-3	Superscalar Classification of M680x0 Privileged Instructions	10-7
10-4	Superscalar Classification of M680x0 Floating-Point Instructions	10-7
10-5	Effective Address Calculation Times	10-14
10-6	Move Byte and Word Execution Times	10-15
10-7	Move Long Execution Times	10-15
10-8	MOVE16 Execution Times	10-15
10-9	Standard Instruction Execution Time	10-16
10-10	Immediate Instruction Execution Times	10-17
10-11	Single-Operand Instruction Execution Times	10-18
10-12	Clear (CLR) Execution Times	10-18
10-13	Shift/Rotate Execution Times	10-19
10-14	Bit Manipulation (Dynamic Bit Count) Execution Times	10-19
10-15	Bit Manipulation (Static Bit Count) Execution Times	10-20
10-16	Bit Field Execution Times	10-20
10-17	Branch Execution Times	10-21
10-18	JMP, JSR Execution Times	10-21
10-19	Return Instruction Execution Times	10-21
10-20	LEA, PEA, and MOVEM Instruction Execution Times	10-22
10-21	Multiprecision Instruction Execution Times	10-22
10-22	Status Register (SR) Instruction Execution Times	10-23
10-23	MOVES Execution Times	10-23
10-24	Miscellaneous Instruction Execution Times	10-23
10-25	Floating-Point Instruction Execution Times	10-24
10-26	Exception Processing Times	10-26
11-1	With Heat Sink, No Air Flow	11-18
11-2	With Heat Sink, with Air Flow	11-18
11-3	No Heat Sink	11-19
11-4	Support Devices and Products	11-20
C-1	Call-Out Dispatch Table and Module Size	C-4
C-2	FPU Comparison	C-12
C-3	Unimplemented Instructions	C-13

List of Tables

C-4	Unimplemented Data Formats and Data Types	C-13
C-5	UNIX Operating System Calls	C-23
C-6	Instructions Not Handled by the M68060SP	C-26
C-7	Files Provided in an M68060SP Release	C-27
D-1	M68000 Family Instruction Set and Processor Cross-Reference	D-1
D-2	M68000 Family Instruction Set	D-6
D-3	Exception Vector Assignments for the M68000 Family	D-10

SECTION 1 INTRODUCTION

The superscalar MC68060 represents a new line of Motorola microprocessor products. The first generation of the M68060 product line consists of the MC68060, MC68LC060, and MC68EC060. All three microprocessors offer superscalar integer performance of over 100 MIPS at 66 MHz. The MC68060 comes fully equipped with both a floating-point unit (FPU) and a memory management unit (MMU) for high-performance embedded control and desktop applications. For cost-sensitive embedded control and desktop applications where an MMU is required, but the additional cost of a FPU is not justified, the MC68LC060 offers high-performance at a low cost. Specifically designed for low-cost embedded control applications, the MC68EC060 eliminates both the FPU and MMU, permitting designers to leverage MC68060 performance while avoiding the cost of unnecessary features. Throughout this product brief, all references to the MC68060 also refer to the MC68LC060 and the MC68EC060, unless otherwise noted.

Leveraging many of the same performance enhancements used by RISC designs as well as providing innovative architectural techniques, the MC68060 harnesses new levels of performance for the M68000 family. Incorporating 2.5 million transistors on a single piece of silicon, the MC68060 employs a deep pipeline, dual issue superscalar execution, a branch cache, a high-performance floating-point unit (MC68060 only), eight Kbytes each of on-chip instruction and data caches, and dual on-chip demand paging MMUs (MC68060 and MC68LC060 only). The MC68060 allows simultaneous execution of two integer instructions (or an integer and a float instruction) and one branch instruction during each clock.

The MC68060 features a full internal Harvard architecture. The instruction and data caches are designed to support concurrent instruction fetch, operand read and operand write references on every clock. Separate 8-Kbyte instruction and 8-Kbyte data caches can be frozen to prevent allocation over time-critical code or data. The independent nature of the caches allows instruction stream fetches, data-stream fetches, and external accesses to occur simultaneously with instruction execution. The operand data cache is four-way banked to permit simultaneous read and write access each clock.

A very high bandwidth internal memory system coupled with the compact nature of the M68000 family code allows the MC68060 to achieve extremely high levels of performance, even when operating from low-cost memory such as a 32-bit wide dynamic random access memory system.

Instructions are fetched from the internal cache or external memory by a four-stage instruction fetch pipeline. The MC68060 variable-length instruction system is internally decoded into a fixed-length representation and channeled into an instruction buffer. The instruction buffer acts as a FIFO which provides a decoupling mechanism between the instruction fetch

Introduction

unit and the operand execution units. Fixed format instructions are dispatched to dual four-stage pipelined RISC operand execution engines where they are then executed.

The branch cache also plays a major role in achieving the high performance levels of the MC68060. It has been implemented such that most branches are executed in zero cycles. Using a technique known as branch folding, the branch cache allows the instruction fetch pipeline to detect and change the instruction prefetch stream before the change of flow affects the instruction execution engines, minimizing the need for pipeline refill.

In addition to substantial cost and performance benefits, the MC68060 also offers advantages in power consumption and power management. The MC68060 automatically minimizes power dissipation by using a fully-static design, dynamic power management, and low-voltage operation. It automatically powers-down internal functional blocks that are not needed on a clock-by-clock basis. Explicitly the MC68060 power consumption can be controlled from the operating system. Although the MC68060 operates at a lower operating voltage, it directly interfaces to both 3-V and 5-V peripherals and logic.

Complete code compatibility with the M68000 family allows the designer to draw on existing code and past experience to bring products to market quickly. There is also a broad base of established development tools, including real-time kernels, operating systems, languages, and applications, to assist in product design. The functionality provided by the MC68060 makes it the ideal choice for a range of high-performance embedded applications and computing applications. With M68000 family code compatibility, the MC68060 provides a range of upgrade opportunities to virtually any existing MC68040 application.

1.1 DIFFERENCES AMONG M68060 FAMILY MEMBERS

Because the functionality of individual M68060 family members are similar, this manual is organized so that the reader will take the following differences into account while reading the rest of this manual. Unless otherwise noted, all references to MC68060, with the exception of the differences outlined below, will apply to the MC68060, MC68LC060, and MC68EC060. The following paragraphs describe how the MC68LC060 and the MC68EC060 differ from the MC68060.

1.1.1 MC68LC060

The MC68LC060 is a derivative of the MC68060. The MC68LC060 has the same execution unit and MMU as the MC68060, but has no FPU. The MC68LC060 is 100% pin compatible with the MC68060. Disregard all information concerning the FPU when reading this manual. The following difference exists between the MC68LC060 and the MC68060:

- The MC68LC060 does not contain an FPU. When floating-point instructions are encountered, a floating-point disabled exception is taken.

1.1.2 MC68EC060

The MC68EC060 is a derivative of the MC68060. The MC68EC060 has the same execution unit as the MC68060, but has no FPU or paged MMU, which embedded control applications generally do not require. Disregard information concerning the FPU and MMU when reading this manual. The MC68EC060 is pin compatible with the MC68060. The following differences exist between the MC68EC060 and the MC68060:

- The MC68EC060 does not contain an FPU. When floating-point instructions are encountered, a floating-point disabled exception is taken.
- The $\overline{\text{MDIS}}$ pin name has been changed to the JS0 pin and is included for boundary scan purposes only.

1.1.2.1 ADDRESS TRANSLATION DIFFERENCES. Although the MC68EC060 has no paged MMU, the four transparent translation registers (ITT0, ITT1, DTT0, and DTT1) and the default transparent translation (defined by certain bits in the translation control register (TCR)) operate normally and can still be used to assign cache modes and supervisor and write protection for given address ranges. All addresses can be mapped by the four transparent translation registers (TTRs) and the default transparent translation.

1.1.2.2 INSTRUCTION DIFFERENCES. The PFLUSH and PLPA instructions, the supervisor root pointer (SRP) and user root pointer (URP) registers, and the E- and P-bits of the TCR are not supported by the MC68EC060 and must not be used. Use of these instructions and registers in the MC68EC060 exhibits poor programming practice since no useful results can be achieved. Any functional anomalies that may result from their use will require system software modification (to remove offending instructions) to achieve proper operation.

The PLPA instruction operates normally except that when an address misses in the four TTRs, instead of performing a table search operation, the access cache mode and write protection properties are defined by the default transparent translation bits in the TCR. The address register contents are never changed since all addresses are always transparently

Introduction

translated. The PLPA instruction can only generate an access error exception only on supervisor or write protection violation cases. The PFLUSH instruction operates as a virtual NOP instruction.

When the MOVEC instruction is used to access the SRP and URP registers and the E- and P-bits in the TCR, no exceptions are reported. However, those bits are undefined for the MC68EC060 and must not be used.

1.2 FEATURES

The main features of the MC68060 are as follows:

- 1.6–1.7 Times the MC68040 Performance at the Same Clock Rate with Existing Compilers. 3.2–3.4 Times the Performance of a 25 MHZ MC68040.
- Harvard Architecture with Independent, Decoupled Fetch and Execution Pipelines.
- Branch Prediction Logic with a 256-Entry, 4-Way Set-Associative, Virtual-Mapped Branch Cache for Improved Branch Instruction Performance.
- A Superscalar Pipeline and Dual Integer Execution Units Achieving Simultaneous, but not Out-of-Order Instruction Execution.
- An IEEE Standard, MC68040- and MC68881-/MC68882-Compatible FPU.
- An MC68040-Compatible Paged Memory Management Unit with Dual 64-Entry Address Translation Caches
- Dual 8-Kbyte Caches (Instruction Cache and Data Cache)
- A Flexible, High-Bandwidth Synchronous Bus Interface
- User Object-Code Compatible with All Earlier M68000 Microprocessors

1.3 ARCHITECTURE

The instruction fetch unit (IFU) is a four-stage pipeline for prefetching instructions. The dual operand execution pipelines (OEPs) (named primary" (pOEP) and secondary (sOEP)) are four-stage pipelines for decoding the instructions, fetching the required operand(s), and then performing the actual execution of the instructions. Since the IFU and OEP are decoupled by a first-in-first-out (FIFO) instruction buffer, the IFU is able to prefetch instructions in advance of their actual use by the OEPs.

The MC68060 is designed to maximize the OEP's efficiency through the use of a superscalar pipeline architecture. This architectural advance improves processor performance dramatically by exploiting instruction-level parallelism. The term superscalar denotes the ability to detect, dispatch, execute, and return results from more than one instruction during each machine cycle from an otherwise conventional instruction stream.

As a result, multiple instructions may be executed in a single machine cycle. Since the dual OEPs perform in a lock-step mode of operation, the multiple instruction execution is performed simultaneously, but not out-of-order. The net effect is a software-invisible pipeline architecture capable of sustained execution rates of < 1 machine cycle per instruction of the M68000 instruction set.

Architectural highlights of the MC68060 include:

- Four-Stage Instruction Fetch Unit (IFU)
 - 64-Entry Instruction Address Translation Cache (ATC), Organized as 4-Way Set-Associative, for Fast Virtual-to-Physical Address Translations
 - 8- Kbyte, 4-Way Set-Associative, Physically-Mapped Instruction Cache
 - 256-Entry, 4-Way Set-Associative, Virtually-Mapped Branch Cache, Which Predicts the Direction of Branches Based on Their Past Execution History
 - 96-Byte FIFO Instruction Buffer to Allow Decoupling of the IFU and OEPs
- Four-Stage Execution Pipelines Featuring Primary Pipeline (pOEP), Secondary Pipeline (sOEP), and Register File (RGF) Containing Program-Visible General Registers
 - 64-Entry Operand Data ATC, Organized as 4-Way Set-Associative, for Fast Virtual-to-Physical Address Translations
 - 8- Kbyte, 4-Way Set-Associative, Physically-Mapped Operand Data Cache
 - The Operand Data Cache Is Organized in a Banked Structure to Allow Simultaneous Read/Write Accesses
 - Integer Execute Engines Optimized to Perform Most Instruction Executions in a Single Machine Cycle
 - Floating-Point Execute Engine, with Floating-Point Register File, Optimized for Performance with Extended-Precision-Wide Internal Datapaths.
 - Four-Entry Store Buffer and One-Entry Push Buffer That Provide the Performance Feature of Decoupling the Processor Pipeline from External Memory for Certain Cache Modes of Operation.

This pipeline architecture supports extremely high data transfer rates within the MC68060 processor. The on-chip instruction and operand data caches provide 600 MBytes/sec @ 50 MHz to the pipelines, while the integer execute engines can support sustained transfer rates of 1.2 GBytes/sec.

1.4 PROCESSOR OVERVIEW

The following paragraphs provide a general description of the MC68060.

1.4.1 Functional Blocks

Figure 1-1 illustrates a simplified block diagram of the MC68060.

1 Introduction

The architecture of the MC68060 processor is implemented in the following major blocks:

- Execution Unit
 - Instruction Fetch Unit
 - Integer Unit
 - FPU
- Memory Units
 - Instruction Memory Unit
 - Instruction ATC
 - Instruction Cache
 - Instruction Cache Controller
 - Data Memory Unit
 - Data ATC
 - Data Cache
 - Data Cache Controller
- Bus Controller

These major units execute concurrently to maximize sustained performance. Note that the caches reside on separate buses allowing concurrent instruction fetch, data read, and data write operations (internal Harvard architecture).

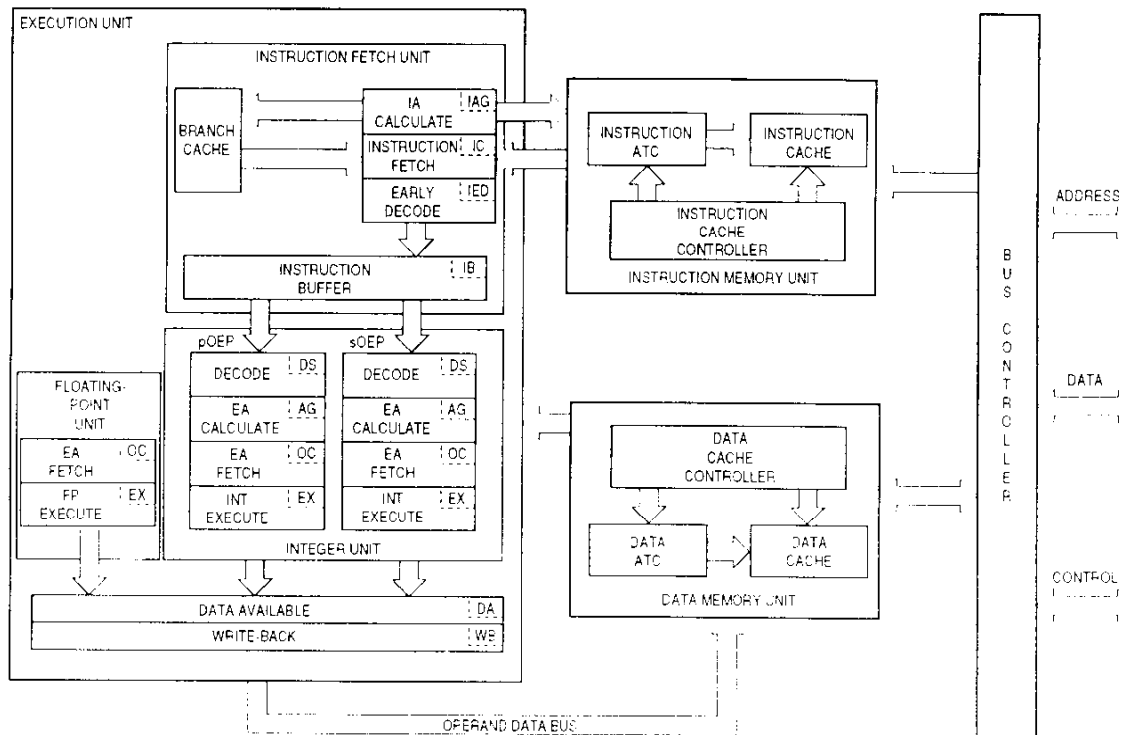

Figure 1-1. MC68060 Block Diagram

The integer unit implements a subset of the MC68040 instruction set. The FPU implements a subset of the MC68881/2 coprocessor instruction set. The instruction and data memory units manage the ATCs and the instruction and data caches. The ATCs provide on-chip storage for the paged MMU's most recently used address translations. The data and instruction caches include the logic necessary to read, write, update, invalidate, and flush the caches. The bus controller manages the interface between the MMUs and the external bus. Snoop invalidation is supported to maintain cache consistency by monitoring the external bus when the processor is not the current master.

1.4.2 Integer Unit

The MC68060's integer unit carries out logical and arithmetic operations. The integer unit contains an instruction fetch controller, an instruction execution controller, and a branch target cache. The superscalar design of the MC68060 provides dual execution pipelines in the instruction execution controller, providing simultaneous execution.

The superscalar operation of the integer unit can be disabled in software, turning off the second execution pipeline for debugging. Disabling the superscalar operation also lowers performance and power consumption.

1.4.2.1 INSTRUCTION FETCH UNIT. The instruction fetch unit contains an instruction fetch pipeline and the logic that interfaces to the branch cache. The instruction fetch pipeline consists of four stages, providing the ability to prefetch instructions in advance of their actual use in the instruction execution controller. The continuous fetching of instructions keeps the instruction execution controller busy for the greatest possible performance. Every instruction passes through each of the four stages before entering the instruction execution controller. The four stages in the instruction fetch pipeline are:

1. Instruction Address Calculation (IAG)—The virtual address of the instruction is determined.
2. Instruction Fetch (IC)—The instruction is fetched from memory.
3. Early Decode (IED)—The instruction is pre-decoded for pipeline control information.
4. Instruction Buffer (IB)—The instruction and its pipeline control information are buffered until the integer execution pipeline is ready to process the instruction.

The branch cache plays a major role in achieving the performance levels of the MC68060. The concept of the branch cache is to provide a mechanism that allows the instruction fetch pipeline to detect and change the instruction stream before the change of flow affects the instruction execution controller.

The branch cache is examined for a valid branch entry after each instruction fetch address is generated in the instruction fetch pipeline. If a hit does not occur in the branch target cache, the instruction fetch pipeline continues to fetch instructions sequentially. If a hit occurs in the branch cache, indicating a branch taken instruction, the current instruction stream is discarded and a new instruction stream is fetched starting at the location indicated by the branch cache.

1.4.2.2 INTEGER UNIT. The integer unit contains dual integer execution pipelines, interface logic to the FPU, and control logic for data written to the data cache and MMU. The superscalar design of the dual integer execution pipelines provide for simultaneous instruction execution, which allows for processing more than one instruction during each machine clock cycle. The net effect of this is a software invisible pipeline capable of sustained execution rates of less than one machine clock cycle per instruction for the M68000 instruction set.

The integer unit's control logic pulls an instruction pair from the instruction buffer every machine clock cycle, stopping only if the instruction information is not available or if an integer execution pipeline hold condition exists. The six stages in the dual integer execution pipelines are:

1. Decode (DS)—The instruction is fully decoded.
2. Effective Address Calculation (AG)—If the instruction calls for data from memory, the location of the data is calculated.
3. Effective Address Fetch (OC)—Data is fetched from the memory location.
4. Integer Execution (EX)—The data is manipulated during execution.
5. Data Available (DA)—The result is available.
6. Write-Back (WB)—The resulting data is written back to on-chip caches or external memory.

The MC68060 is optimized for most integer instructions to execute in one machine clock cycle. If during the instruction decode stage, the instruction is determined to be a floating-point instruction, it will be passed to the FPU after the effective address calculate stage. If data is to be written to either the on-chip caches or external memory after instruction execution, the write-back stage holds the data until memory is ready to receive it.

1.4.2.3 FLOATING-POINT UNIT. Floating-point math is distinguished from integer math, which deals only with whole numbers and fixed decimal point locations. The IEEE-compatible MC68060's FPU computes numeric calculations with a variable decimal point location. Consolidating the FPU on-chip speeds up overall processing and eliminates the interfacing overhead associated with external accelerators. The MC68060's FPU operates in parallel with the integer unit. The FPU performs numeric calculations while the integer unit continues integer processing.

The FPU has been optimized for the most frequently used instructions and data types to provide the highest possible performance. The FPU can also be disabled in software to reduce system power consumption.

The MC68060 is compatible with the *ANSI/IEEE Standard 754 for Binary Floating-Point Arithmetic*. The MC68060's FPU has been optimized to execute the most commonly used subset of the MC68881/MC68882 instruction sets. Software emulates floating-point instructions not directly supported in hardware. Refer to **Appendix C MC68060 Software Package** for details on software emulation. The MC68060FPSP provides the following features:

- Arithmetic and Transcendental Instructions
- IEEE-Compliant Exception Handlers
- Unimplemented Data Type and Data Format Handlers

1.4.2.4 MEMORY UNITS. The MC68060 contains independent instruction and data memory units. Each memory unit consists of an 8-Kbyte cache, a cache controller, and an ATC. The full addressing range of the MC68060 is 4 Gbytes. Even though most MC68060 systems implement a much smaller physical memory, by using virtual memory techniques, the system can appear to have a full 4 Gbytes of memory available to each user program. Each MMU fully supports demand-paged virtual-memory operating systems with either 4- or 8-Kbyte page sizes. Each MMU protects supervisor areas from accesses by user programs and provides write protection on a page-by-page basis. For maximum efficiency, each MMU operates in parallel with other processor activities. The MMUs can be disabled for emulator and debugging support.

1.4.2.5 ADDRESS TRANSLATION CACHES. The 64-entry, four-way, set-associative ATCs store recently used logical-to-physical address translation information as page descriptors for instruction and data accesses. Each MMU initiates address translation by searching for a descriptor containing the address translation information in the ATC. If the descriptor does not reside in the ATC, the MMU performs external bus cycles through the bus controller to search the translation tables in physical memory. After being located, the page descriptor is loaded into the ATC, and the address is correctly translated for the access.

1.4.2.6 INSTRUCTION AND DATA CACHES. Studies have shown that typical programs spend much of their execution time in a few main routines or tight loops. Earlier members of the M68000 family took advantage of this locality-of-reference phenomenon to varying degrees. The MC68060 takes further advantage of cache technology with its two, independent, on-chip physical caches, one for instructions and one for data. The caches reduce the processor's external bus activity and increase CPU throughput by lowering the effective memory access time. For a typical system design, the large caches of the MC68060 yield a very high hit rate, providing a substantial increase in system performance.

The autonomous nature of the caches allows instruction-stream fetches, data-stream fetches, and external accesses to occur simultaneously with instruction execution. For example, if the MC68060 requires both an instruction access and an external peripheral access and if the instruction is resident in the on-chip cache, the peripheral access proceeds unimpeded rather than being queued behind the instruction fetch. If a data operand is also required and it is resident in the data cache, it can be accessed without hindering either the instruction access or the external peripheral access. The parallelism inherent in the MC68060 also allows multiple instructions that do not require any external accesses to exe-

ecute concurrently while the processor is performing an external access for a previous instruction.

Each MC68060 cache is 8 Kbytes, accessed by physical addresses. The data cache can be configured as write-through or deferred copyback on a page basis. This choice allows for optimizing the system design for high performance if deferred copyback is used.

Cachability of data in each memory page is controlled by two bits in the page descriptor. Cachable pages can be either write-through or copyback, with no write-allocate for misses to write-through pages.

The MC68060 implements a four-entry store buffer that maximizes system performance by decoupling the integer pipeline from the external system bus. When needed, the store buffer allows the pipeline to generate writes every clock cycle until full, even if the system bus runs at a slower speed than the processor.

1.4.2.6.1 Cache Organization. The instruction and data caches are each organized as four-way set associative, with 16-byte lines. Each line of data has associated with it an address tag and state information that shows the line's validity. In the data cache, the state information indicates whether the line is invalid, valid, or dirty.

1.4.2.6.2 Cache Coherency. The MC68060 has the ability to watch or snoop the external bus during accesses by other bus masters, maintaining coherency between the MC68060's caches and external memory systems. External bus cycles can be flagged on the bus as snoopable or nonsnoopable. When an external cycle is marked as snoopable, the bus snooper checks the caches and invalidates the matching data. Although the integer execution units and the bus snooper circuit have access to the on-chip caches, the snooper has priority over the execution units.

1.4.3 Bus Controller

The bus is implemented as a nonmultiplexed, fully synchronous protocol that is clocked off the rising edge of the input clock. The bus controller operates concurrently with all other functional units of the MC68060 to maximize system throughput. The timing of the bus is fully configurable to match external memory requirements.

1.5 PROCESSING STATES

The processor is always in one of three states: normal processing, exception processing, or halted. It is in the normal processing state when executing instructions, fetching instructions and operands, and storing instruction results.

Exception processing is the transition from program processing to system, interrupt, and exception handling. Exception processing includes fetching the exception vector, stacking operations, and refilling the instruction pipe caused after an exception. The processor enters exception processing when an exceptional internal condition arises such as tracing an instruction, an instruction results in a trap, or executing specific instructions. External conditions, such as interrupts and access errors, also cause exceptions. Exception processing ends when the first instruction of the exception handler begins to execute.



The processor halts when it receives an access error or generates an address error while in the exception processing state. For example, if during exception processing of one access error another access error occurs, the MC68060 is unable to complete the transition to normal processing and cannot save the internal state of the machine. The processor assumes that the system is not operational and halts. Only an external reset can restart a halted processor. Note that when the processor executes a STOP or LPSTOP instruction, it is in a special type of normal processing state, one without bus cycles. The processor stops, but it does not halt and can be restored by an interrupt or reset.

1.6 PROGRAMMING MODEL

The MC68060 programming model is separated into two privilege modes: supervisor and user. The integer unit identifies a logical address by accessing either the supervisor or user address space, maintaining the differentiation between supervisor and user modes. The MMUs use the indicated privilege mode to control and translate memory accesses, protecting supervisor code, data, and resources from user program accesses. Refer to **1.1.2.1 Address Translation Differences** for details concerning the MC68060 address translation.

Programs access registers based on the indicated mode. User programs can only access registers specific to the user mode; whereas, system software executing in the supervisor mode can access all registers, using the control registers to perform supervisory functions. User programs are thus restricted from accessing privileged information, and the operating system performs management and service tasks for the user programs by coordinating their activities. This difference allows the supervisor mode to protect system resources from uncontrolled accesses.

Most instructions execute in either mode, but some instructions that have important system effects are privileged and can only execute in the supervisor mode. For instance, user programs cannot execute the STOP or RESET instructions. To prevent a user program from entering the supervisor mode, except in a controlled manner, instructions that can alter the S-bit in the status register (SR) are privileged. The TRAP instructions provide controlled access to operating system services for user programs.

If the S-bit in the SR is set, the processor executes instructions in the supervisor mode. Because the processor performs all exception processing in the supervisor mode, all bus cycles generated during exception processing are supervisor references, and all stack accesses use the active supervisor stack pointer. If the S-bit of the SR is clear, the processor executes instructions in the user mode. The bus cycles for an instruction executed in the user mode are user references. The values on the transfer modifier pins indicate either supervisor or user accesses.

The processor utilizes the user mode and the user programming model when it is in normal processing. During exception processing, the processor changes from user to supervisor mode. Exception processing saves the current value of the SR on the active supervisor stack and then sets the S-bit, forcing the processor into the supervisor mode. To return to the user mode, a system routine must execute one of the following instructions: MOVE to SR, ANDI to SR, EORI to SR, ORI to SR, or RTE, which execute in the supervisor mode.

1 Introduction

modifying the S-bit of the SR. After these instructions execute, the instruction pipeline is flushed and is refilled from the appropriate address space.

The MC68060 integrates the functions of the integer unit, FPU, and MMU. The registers depicted in the programming model (see Figure 1-2) provide operand storage and control for these three units. The registers are partitioned into two levels of privilege modes: user and supervisor. The user programming model is the same as the user programming model of the MC68040, which consists of 16 general-purpose 32-bit registers, two control registers, eight 80-bit floating-point data registers, a floating-point control register, a floating-point status register, and a floating-point instruction address register.

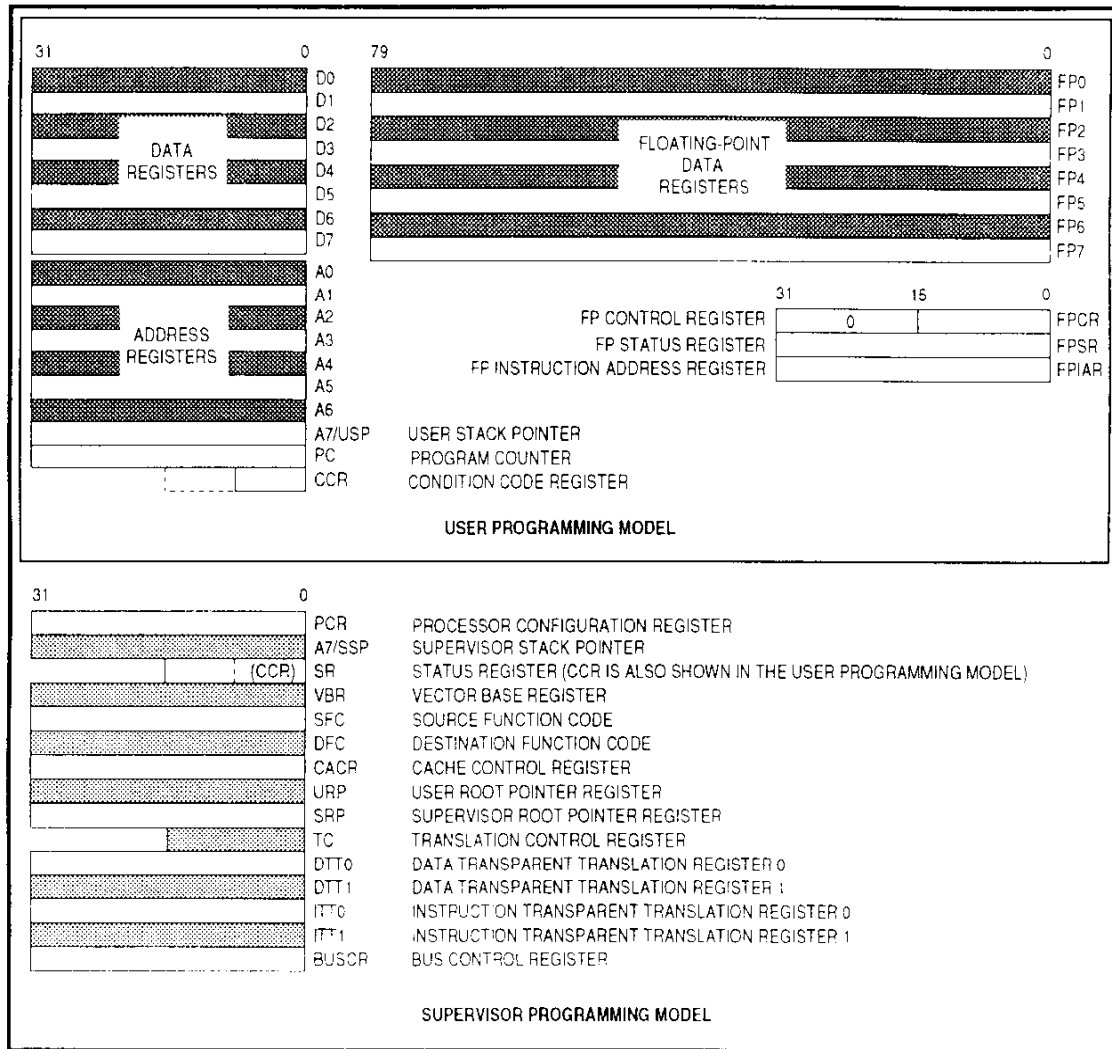

Figure 1-2. Programming Model

Only system programmers can use the supervisor programming model to implement operating system functions, I/O control, and memory management subsystems. This supervisor/user distinction in the M68000 family architecture allows for the writing of application soft-

ware that executes in the user mode and migrates to the MC68060 from any M68000 family platform without modification. The supervisor programming model contains the control features that system designers need to modify system software when porting to a new design. For example, only the supervisor software can read or write to the TTRs of the MC68060. The existence of the TTRs does not affect the programming resources of user application programs.

The user programming model includes eight data registers, seven address registers, and a stack pointer register. The address registers and stack pointer can be used as base address registers or software stack pointers, and any of the 16 registers can be used as index registers. Two control registers are available in the user mode—the program counter (PC), which usually contains the address of the instruction that the MC68060 is executing, and the lower byte of the SR, which is accessible as the condition code register (CCR). The CCR contains the condition codes that reflect the results of a previous operation and can be used for conditional instruction execution in a program.

The supervisor programming model includes the upper byte of the SR, which contains operation control information. The vector base register (VBR) contains the base address of the exception vector table, which is used in exception processing. The source function code (SFC) and destination function code (DFC) registers contain 3-bit function codes. These function codes can be considered extensions to the 32-bit logical address. The processor automatically generates function codes to select address spaces for data and program accesses in the user and supervisor modes. Some instructions use the alternate function code registers to specify the function codes for various operations.

The processor configuration register (PCR) contains bits which control the internal pipelines of the MC68060 design.

The bus control register (BUSCR) is used to control software emulation of locked bus transactions.

The cache control register (CACR) controls enabling of the on-chip instruction and data caches of the MC68060. The supervisor root pointer (SRP) and user root pointer (URP) registers point to the root of the address translation table tree to be used for supervisor and user mode accesses.

The translation control register (TCR) enables logical-to-physical address translation and selects either 4- or 8-Kbyte page sizes. There are four TTRs, two for instruction accesses and two for data accesses. These registers allow portions of the logical address space to be transparently mapped and accessed without the use of resident descriptors in an ATC.

The user programming model can also access the entire floating-point programming model. The eight 80-bit floating-point data registers are analogous to the integer data registers. A 32-bit floating-point control register (FPCR) contains an exception enable byte that enables and disables traps for each class of floating-point exceptions and a mode byte that sets the user-selectable rounding and precision modes. A floating-point status register (FPSR) contains a condition code byte, quotient byte, exception status byte, and accrued exception byte. A floating-point exception handler can use the address in the 32-bit floating-point

instruction address register (FPIAR) to locate the floating-point instruction that has caused an exception. Instructions that do not modify the FPIAR can be used to read the FPIAR in the exception handler without changing the previous value.

1.7 DATA FORMAT SUMMARY

The MC68060 supports the basic data formats of the M68000 family. Some data formats apply only to the integer unit, some only to the FPU, and some to both. In addition, the instruction set supports operations on other data formats such as memory addresses.

The operand data formats supported by the integer unit are the standard two's-complement data formats defined in the M68000 family architecture plus a new data format (16-byte block) for the MOVE16 instruction. Registers, memory, or instructions themselves can contain integer unit operands. The operand size for each instruction is either explicitly encoded in the instruction or implicitly defined by the instruction operation.

Whenever an integer is used in a floating-point operation, the FPU automatically converts it to an extended-precision floating-point number before using the integer. The FPU implements single-, double-, and extended-precision floating-point data formats as defined by the IEEE 754 standard. The FPU does not directly support packed decimal real format. However, software emulation supports this format via the unimplemented data format vector. Additionally, each data format has a special encoding that represents one of five data types: normalized numbers, denormalized numbers, zeros, infinities, and not-a-numbers (NaNs). Table 1-1 lists the data formats for both the integer unit and the FPU. Refer to M68000PM/AD, *M68000 Family Programmer's Reference Manual*, for details on data format organization in registers and memory.

Table 1-1. Data Formats

Operand Data Format	Size	Supported In	Notes
Bit	1 Bit	Integer Unit	—
Bit Field	1–32 Bits	Integer Unit	Field of Consecutive Bits
Binary-Coded Decimal (BCD)	8 Bits	Integer Unit	Packed: 2 Digits/Byte; Unpacked: 1 Digit/Byte
Byte Integer	8 Bits	Integer Unit, FPU	—
Word Integer	16 Bits	Integer Unit, FPU	—
Long-Word Integer	32 Bits	Integer Unit, FPU	—
16-Byte	128 Bits	Integer Unit	Memory Only, Aligned to 16-Byte Boundary
Single-Precision Real	32 Bits	FPU	1-Bit Sign, 8-Bit Exponent, 23-Bit Fraction
Double-Precision Real	64 Bits	FPU	1-Bit Sign, 11-Bit Exponent, 52-Bit Fraction
Extended-Precision Real	96 Bits	FPU	1-Bit Sign, 15-Bit Exponent, 64-Bit Mantissa

1.8 ADDRESSING CAPABILITIES SUMMARY

The MC68060 supports the basic addressing modes of the M68000 family. The register indirect addressing modes support postincrement, predecrement, offset, and indexing, which are particularly useful for handling data structures common to sophisticated applications and high-level languages. The program counter indirect mode also has indexing and offset capabilities. This addressing mode is typically required to support position-independent software. Besides these addressing modes, the MC68060 provides index sizing and scaling features.

An instruction's addressing mode can specify the value of an operand, a register containing the operand, or how to derive the effective address of an operand in memory. Each addressing mode has an assembler syntax. Some instructions imply the addressing mode for an operand. These instructions include the appropriate fields for operands that use only one addressing mode. Table 1-2 lists a summary of the effective addressing modes for the MC68060. Refer to M68000PM/AD, *M68000 Family Programmer's Reference Manual*, for details on instruction format and addressing modes.

Table 1-2. Effective Addressing Modes

Addressing Modes	Syntax
Register Direct Data Address	Dn An
Register Indirect Address Address with Postincrement Address with Predecrement Address with Displacement	(An) (An)+ -(An) (d ₁₆ ,An)
Address Register Indirect with Index 8-Bit Displacement Base Displacement	(d ₈ ,An,Xn) (bd,An,Xn)
Memory Indirect Postindexed Preindexed	((bd,An],Xn,od) ((bd,An,Xn],od)
Program Counter Indirect with Displacement	(d ₁₆ ,PC)
Program Counter Indirect with Index 8-Bit Displacement Base Displacement	(d ₈ ,PC,Xn) (bd,PC,Xn)
Program Counter Memory Indirect Postindexed Preindexed	((bd,PC],Xn,od) ((bd,PC,Xn],od)
Absolute Data Addressing Short Long	(xxx).W (xxx).L
Immediate	#<xxx>

1.9 INSTRUCTION SET OVERVIEW

The instruction set is tailored to support high-level languages and is optimized for those instructions most commonly executed. The floating-point instructions for the MC68060 are a commonly used subset of the MC68881/MC68882 instruction set with new arithmetic instructions to explicitly select single- or double-precision rounding. The remaining unimplemented instructions are less frequently used and are efficiently emulated in the MC68060FPSP, maintaining compatibility with the MC68881/MC68882 floating-point coprocessors. The MC68060 instruction set includes MOVE16 which allows high-speed transfers of 16-byte blocks between external devices such as memory to memory or coprocessor to memory. Table 1-3 provides an alphabetized listing of the MC68060 instruction set's opcode, operation, and syntax. Refer to Table 1-4 for notations used in Table 1-3. The left operand in the syntax is always the source operand, and the right operand is the destination operand. Refer to M68000PM/AD, *M68000 Family Programmer's Reference Manual*, for details on instructions used by the MC68060.

Table 1-3. Instruction Set Summary

Opcode	Operation	Syntax
ABCD	BCD Source + BCD Destination + X * Destination	ABCD Dy,Dx ABCD -(Ay),-(Ax)
ADD	Source + Destination * Destination	ADD <ea>,Dn ADD Dn,<ea>
ADDA	Source + Destination * Destination	ADDA <ea>,An
ADDI	Immediate Data + Destination * Destination	ADDI #<data>,<ea>
ADDQ	Immediate Data + Destination * Destination	ADDQ #<data>,<ea>
ADDX	Source + Destination + X * Destination	ADDX Dy,Dx ADDX -(Ay),-(Ax)
AND	Source \wedge Destination * Destination	AND <ea>,Dn AND Dn,<ea>
ANDI	Immediate Data \wedge Destination * Destination	ANDI #<data>,<ea>
ANDI to CCR	Source \wedge CCR * CCR	ANDI #<data>,CCR
ANDI to SR	If supervisor state then Source \wedge SR * SR else TRAP	ANDI #<data>,SR
ASL, ASR	Destination Shifted by count * Destination	ASd Dx,Dy ¹ ASd #<data>,Dy ASd <ea>
Bcc	If condition true then PC + d _n * PC	Bcc <label>
BCHG	-(bit number of Destination) * Z; -(bit number of Destination) * (bit number) of Destination	BCHG Dn,<ea> BCHG #<data>,<ea>
BCLR	-(bit number of Destination) * Z; 0 * bit number of Destination	BCLR Dn,<ea> BCLR #<data>,<ea>
BFCHG	-(bit field of Destination) * bit field of Destination	BFCHG <ea>{offset:width}
BFCLR	0 * bit field of Destination	BFCLR <ea>{offset:width}
BFEXTS	bit field of Source * Dn	BFEXTS <ea>{offset:width},Dn
BFEXTU	bit offset of Source * Dn	BFEXTU <ea>{offset:width},Dn
BFFFO	bit offset of Source Bit Scan * Dn	BFFFO <ea>{offset:width},Dn
BFINS	Dn * bit field of Destination	BFINS Dn,<ea>{offset:width}
BFSET	1s * bit field of Destination	BFSET <ea>{offset:width}
BFTST	bit field of Destination	BFTST <ea>{offset:width}
BKPT	Run breakpoint acknowledge cycle; TRAP as illegal instruction	BKPT #<data>
BRA	PC + d _n * PC	BRA <label>
BSET	-(bit number of Destination) * Z; 1 * bit number of Destination	BSET Dn,<ea> BSET #<data>,<ea>
BSR	SP - 4 * SP; PC * (SP); PC + d _n * PC	BSR <label>
BTST	-(bit number of Destination) * Z;	BTST Dn,<ea> BTST #<data>,<ea>
CAS ⁸	CAS Destination - Compare Operand * cc; if Z, Update Operand * Destination else Destination * Compare Operand	CAS Dc,Du,<ea>
CAS2 ²	CAS2 Destination 1 - Compare 1 * cc; if Z, Destination 2 - Compare * cc; if Z, Update 1 * Destination 1; Update 2 * Destination 2 else Destination 1 * Compare 1; Destination 2 * Compare 2	CAS2 Dc1-Dc2,Du1-Du2,(Rn1)- (Rn2)
CHK	If Dn < 0 or Dn > Source then TRAP	CHK <ea>,Dn
CHK2 ²	If Rn < LB or If Rn > UB then TRAP	CHK2 <ea>,Rn
CINV	If supervisor state then invalidate selected cache lines else TRAP	CINVL <cache>,(An) CINVP <cache>,(An) CINVA <cache>
CLR	0 * Destination	Clr <ea>

Table 1-3. Instruction Set Summary (Continued)

Opcode	Operation	Syntax
CMP	Destination – Source ♦ cc	CMP <ea>,Dn
CMPA	Destination – Source	CMPA <ea>,An
CMPI	Destination – Immediate Data	CMPI #<data>,<ea>
CMPM	Destination – Source ♦ cc	CMPM (Ay)+,(Ax)+
CMP2 ²	Compare Rn < LB or Rn > UB and Set Condition Codes	CMP2 <ea>,Rn
CPUSH	If supervisor state then if data cache push selected dirty data cache lines; invalidate selected cache lines else TRAP	CPUSHL <caches>,(An) CPUSHP <caches>,(An) CPUSHA <caches>
DBcc	If condition false then (Dn-1 ♦ Dn; if Dn ≠ -1 then PC + dn ♦ PC)	DBcc Dn,<label>
DIVS, DIVSL	Destination ÷ Source ♦ Destination	DIVS.W <ea>,Dn32 + 16 ♦ 16r:16q DIVS.L <ea>,Dq32 + 32 ♦ 32q DIVS.L <ea>,Dr:Dq64 + 32 ♦ 32r:32q ² DIVSL.L <ea>,Dr:Dq 32 + 32 ♦ 32r:32q
DIVU, DIVUL	Destination ÷ Source ♦ Destination	DIVU.W <ea>,Dn32 + 16 ♦ 16r:16q DIVU.L <ea>,Dq32 + 32 ♦ 32q DIVU.L <ea>,Dr:Dq64 + 32 ♦ 32r:32q ² DIVUL.L <ea>,Dr:Dq32 + 32 ♦ 32r:32q
EOR	Source ⊕ Destination ♦ Destination	EOR Dn,<ea>
EORI	Immediate Data ⊕ Destination ♦ Destination	EORI #<data>,<ea>
EORI to CCR	Source ⊕ CCR ♦ CCR	EORI #<data>,CCR
EORI to SR	If supervisor state then Source ⊕ SR ♦ SR else TRAP	EORI #<data>,SR
EXG	Rx ♦♦ Ry	EXG Dx,Dy EXG Ax,Ay EXG Dx,Ay EXG Ay,Dx
EXT EXTB	Destination Sign – Extended ♦ Destination	EXT.W Dnextend byte to word EXT.L.L Dnextend word to long word EXTB.L Dn extend byte to long word
FABS	Absolute Value of Source ♦ FPn	FABS.<fmt> <ea>,FPn FABS.X FPm,FPn FABS.X FPn FrABS.<fmt> <ea>,FPn ³ FrABS.X FPm,FPn ³ FrABS.X FPn ³
FADD	Source + FPn ♦ FPn	FADD.<fmt> <ea>,FPn FADD.X FPm,FPn FrADD.<fmt> <ea>,FPn ³ FrADD.X FPm,FPn ³
FBcc	If condition true then PC + dn ♦ PC	FBcc.SIZE <label>
FCMP	FPn – Source	FCMP.<fmt> <ea>,FPn FCMP.X FPm,FPn
FDBcc ²	If condition true then no operation else Dn – 1 ♦ Dn if Dn ≠ -1 then PC + dn ♦ PC else execute next instruction	FDBcc Dn,<label>
FDIV	FPn ÷ Source ♦ FPn	FDIV.<fmt> <ea>,FPn FDIV.X FPm,FPn FrDIV.<fmt> <ea>,FPn ³ FrDIV.X FPm,FPn ³

Table 1-3. Instruction Set Summary (Continued)

Opcode	Operation	Syntax
FINT	Floating-Point Integer Part	FINT.<fmt><ea>,FPn FINT.X FPm,FPn FINT.X FPn
FINTRZ	Floating-Point Integer Part, Round-to-Zero	FINTRZ.<fmt><ea>,FPn FINTRZ.X FPm,FPn FINTRZ.X FPn
FMOVE	Source ♦ Destination	FMOVE.<fmt><ea>,FPn FMOVE.<fmt> FPm,<ea> FMOVE.P FPm,<ea>{Dn} FMOVE.P FPm,<ea>{#k} FrMOVE.<fmt><ea>,FPn ³
FMOVE	Source ♦ Destination	FMOVE.L <ea>,FPcr FMOVE.L FPcr,<ea>
FMOVE ⁹	Register List ♦ Destination Source ♦ Register List	FMOVE.M.X <list>,<ea> ⁴ FMOVE.M.X Dn,<ea> FMOVE.M.X <ea>,<list> ⁴ FMOVE.M.X <ea>,Dn
FMOVE ⁹	Register List ♦ Destination Source ♦ Register List	FMOVE.M.L <list>,<ea> ⁵ FMOVE.M.L <ea>,<list> ⁵
FMUL	Source × FPn ♦ FPn	FMUL.<fmt><ea>,FPn FMUL.X FPm,FPn FrMUL.<fmt><ea>,FPn ³ FrMUL.X FPm,FPn ³
FNEG	-(Source) ♦ FPn	FNEG.<fmt><ea>,FPn FNEG.X FPm,FPn FNEG.X FPn FrNEG.<fmt><ea>,FPn ³ FrNEG.X FPm,FPn ³ FrNEG.X FPn ³
FNOP	None	FNOP
FRESTORE	If in supervisor state then FPU State Frame ♦ Internal State else TRAP	FRESTORE <ea>
FSAVE	If in supervisor state then FPU Internal State ♦ State Frame else TRAP	FSAVE <ea>
FSc ²	If condition true then 1s ♦ Destination else 0s ♦ Destination	FSc.SIZE <ea>
FSGLDIV	FPn ÷ Source ♦ FPn	FSGLDIV.<fmt><ea>,FPn FSGLDIV.X FPm,FPn
FSGLMUL	Source × FPn ♦ FPn	FSGLMUL.<fmt><ea>,FPn FSGLMUL.X FPm,FPn
FSQRT	Square Root of Source ♦ FPn	FSQRT.<fmt><ea>,FPn FSQRT.X FPm,FPn FSQRT.X FPn FrSQRT.<fmt><ea>,FPn ³ FrSQRT FPm,FPn ³ FrSQRT FPn ³
FSUB	FPn – Source ♦ FPn	FSUB.<fmt><ea>,FPn FSUB.X FPm,FPn FrSUB.<fmt><ea>,FPn ³ FrSUB.X FPm,FPn ³
FTRAP ^{cc2}	If condition true then TRAP	FTRAPcc FTRAPcc.W #<data> FTRAPcc.L #<data>
FTST	Condition Codes for Operand ♦ FPCC	FTST.<fmt><ea> FTST.X FPm
ILLEGAL	SSP – 2 ♦ SSP; Vector Offset ♦ (SSP); SSP – 4 ♦ SSP; PC ♦ (SSP); SSp – 2 ♦ SSP; SR ♦ (SSP); Illegal Instruction Vector Address ♦ PC	ILLEGAL
JMP	Destination Address ♦ PC	JMP <ea>

Table 1-3. Instruction Set Summary (Continued)

Opcode	Operation	Syntax
JSR	$SP - 4 \bullet SP; PC \bullet (SP)$ Destination Address $\bullet PC$	JSR <ea>
LEA	<ea> $\bullet An$	LEA <ea>, An
LINK	$SP - 4 \bullet SP; An \bullet (SP)$ $SP \bullet An, SP+d \bullet SP$	LINK An, d _n
LPSTOP	If supervisor state immediate data $\bullet SR$ $SR \bullet$ broadcast cycle STOP else TRAP	LPSTOP #<data>
LSL, LSR	Destination Shifted by count \bullet Destination	LSd Dx, Dy ¹ LSd #<data>, Dy1 LSd <ea>1
MOVE	Source \bullet Destination	MOVE <ea>, <ea>
MOVEA	Source \bullet Destination	MOVEA <ea>, An
MOVE from CCR	CCR \bullet Destination	MOVE CCR, <ea>
MOVE to CCR	Source \bullet CCR	MOVE <ea>, CCR
MOVE from SR	If supervisor state then SR \bullet Destination else TRAP	MOVE SR, <ea>
MOVE to SR	If supervisor state then Source \bullet SR else TRAP	MOVE <ea>, SR
MOVE USP	If supervisor state then USP \bullet An or An \bullet USP else TRAP	MOVE USP, An MOVE An, USP
MOVE16	Source block \bullet Destination block	MOVE16 (Ax)+, (Ay)+ ⁶ MOVE16 (xxx).L, (An) MOVE16 (An), (xxx).L MOVE16 (An)+, (xxx).L
MOVEC	If supervisor state then Rc \bullet Rn or Rn \bullet Rc else TRAP	MOVEC Rc, Rn MOVEC Rn, Rc
MOVEM	Registers \bullet Destination Source \bullet Registers	MOVEM <list>, <ea> ⁴ MOVEM <ea>, <list> ⁴
MOVEP ²	Source \bullet Destination	MOVEP Dx, (d _n , Ay) MOVEP (d _n , Ay), Dx
MOVEQ	Immediate Data \bullet Destination	MOVEQ #<data>, D _n
MOVES	If supervisor state then Rn \bullet Destination [DFC] or Source [SFC] \bullet Rn else TRAP	MOVES Rn, <ea> MOVES <ea>, Rn
MULS	Source \times Destination \bullet Destination	MULS.W <ea>, D _n 16 \times 16 \bullet 32 MULS.L <ea>, D1 32 \times 32 \bullet 32 MULS.L <ea>, Dh-D1 32 \times 32 \bullet 64 ²
MULU	Source \times Destination \bullet Destination	MULU.W <ea>, D _n 16 \times 16 \bullet 32 MULU.L <ea>, D1 32 \times 32 \bullet 32 MULU.L <ea>, Dh-D1 32 \times 32 \bullet 64 ²
NBCD	0 - (Destination) \div 10 - X \bullet Destination	NBCD <ea>
NEG	0 - (Destination) \bullet Destination	NEG <ea>
NEGX	0 - (Destination) - X \bullet Destination	NEGX <ea>
NOP	None	NOP
NOT	\sim Destination \bullet Destination	NOT <ea>
OR	Source V Destination \bullet Destination	OR <ea>, D _n OR D _n , <ea>
ORI	Immediate Data V Destination \bullet Destination	ORI #<data>, <ea>
ORI to CCR	Source V CCR \bullet CCR	ORI #<data>, CCR

Table 1-3. Instruction Set Summary (Continued)

Opcode	Operation	Syntax
ORI to SR	If supervisor state then Source V SR • SR else TRAP	ORI #<data>,SR
PACK	Source (Unpacked BCD) + adjustment • Destination (Packed BCD)	PACK -(Ax),-(Ay),#(adjustment) PACK Dx,Dy,#(adjustment)
PEA	SP - 4 • SP; <ea> • (SP)	PEA <ea>
PFLUSH ⁷	If supervisor state then invalidate instruction and data ATC entries for destination address else TRAP	PFLUSH (An) PFLUSHN (An) PFLUSHA PFLUSHAN
PLPA	If supervisor state then logical address translate to physical address • An else TRAP	PLPAR (An) PLPAW (An)
RESET	If supervisor state then Assert \overline{RSTO} Line else TRAP	RESET
ROL, ROR	Destination Rotated by count • Destination	ROd Rx,Dy1
ROXL, ROXR	Destination Rotated with X by count • Destination	ROXd Dx,Dy ¹ ROXd #<data>,Dy ¹ ROXd <ea> ¹
RTD	(SP) • PC; SP + 4 + d _n • SP	RTD #(d _n)
RTE	If supervisor state then (SP) • SR; SP + 2 • SP; (SP) • PC; SP + 4 • SP; restore state and deallocate stack according to (SP) else TRAP	RTE
RTR	(SP) • CCR; SP + 2 • SP; (SP) • PC; SP + 4 • SP	RTR
RTS	(SP) • PC; SP + 4 • SP	RTS
SBCD	Destination ₁₀ - Source ₁₀ - X • Destination	SBCD Dx,Dy SBCD -(Ax),-(Ay)
Scc	If condition true then 1s • Destination else 0s • Destination	Scc <ea>
STOP	If supervisor state then Immediate Data • SR; STOP else TRAP	STOP #<data>
SUB	Destination - Source • Destination	SUB <ea>,Dn SUB Dn,<ea>
SUBA	Destination - Source • Destination	SUBA <ea>,An
SUBI	Destination - Immediate Data • Destination	SUBI #<data>,<ea>
SUBQ	Destination - Immediate Data • Destination	SUBQ #<data>,<ea>
SUBX	Destination - Source - X • Destination	SUBX Dx,Dy SUBX -(Ax),-(Ay)
SWAP	Register 31-16 • Register 15-0	SWAP Dn
TAS	Destination Tested • Condition Codes; 1 • bit 7 of Destination	TAS <ea>
TRAP	SSP - 2 • SSP; Format + Offset • (SSP); SSP - 4 • SSP; PC • (SSP); SSP - 2 • SSP; SR • (SSP); Vector Address • PC	TRAP #<vector>
TRAPcc	If cc then TRAP	TRAPcc TRAPcc.W #<data> TRAPcc.L #<data>
TRAPV	If V then TRAP	TRAPV
TST	Destination Tested • Condition Codes	TST <ea>
UNLK	An • SP; (SP) • An; SP + 4 • SP	UNLK An
UNPK	Source (Packed BCD) + adjustment • Destination (Unpacked BCD)	UNPACK -(Ax),-(Ay),#(adjustment) UNPACK Dx,Dy,#(adjustment)



Table 1-3. Instruction Set Summary (Continued)

Opcode	Operation	Syntax
--------	-----------	--------

NOTES:

1. Where d is direction, left or right.
2. Emulation support only, not supported in hardware.
3. Where r is rounding precision, single or double precision.
4. List refers to register.
5. List refers to control registers only.
6. MOVE16 (ax)+,(ay)+ is functionally the same as MOVE16 (ax),(ay)+ when ax = ay. The address register is only incremented once, and the line is copied over itself rather than to the next line.
7. Not available for the MC68EC060.
8. Emulation support for misaligned operands.
9. Emulation support for FMCVEM with dynamic register list.

1.10 NOTATIONAL CONVENTIONS

Table 1-4 lists the notation conventions used throughout this manual.

Table 1-4. Notational Conventions

Single- And Double-Operand Operations	
+	Arithmetic addition or postincrement indicator.
-	Arithmetic subtraction or predecrement indicator.
x	Arithmetic multiplication.
/	Arithmetic division or conjunction symbol.
~	Invert; operand is logically complemented.
•	Logical AND
+	Logical OR
⊕	Logical exclusive OR
♦	Source operand is moved to destination operand.
♦♦	Two operands are exchanged.
<op>	Any double-operand operation.
<operand>tested	Operand is compared to zero and the condition codes are set appropriately.
sign-extended	All bits of the upper portion are made equal to the high-order bit of the lower portion.
Other Operations	
TRAP	Equivalent to Format + Offset Word ♦ (SSP); SSP - 2 ♦ SSP; PC ♦ (SSP); SSP - 4 ♦ SSP; SR ♦ (SSP); SSP - 2 ♦ SSP; (Vector) ♦ PC
STOP	Enter the stopped state, waiting for interrupts.
<operand>10	The operand is BCD; operations are performed in decimal.
If <condition> then <operations> else <operations>	Test the condition. If true, the operations after "then" are performed. If the condition is false and the optional "else" clause is present, the operations after "else" are performed. If the condition is false and else is omitted, the instruction performs no operation. Refer to the Bcc instruction description as an example.
Register Specification	
An	Any Address Register n (example: A3 is address register 3)
Ax, Ay	Source and destination address registers, respectively.
BR	Base Register—An, PC, or suppressed.
Dc	Data register D7–D0, used during compare.
Dh, Dl	Data registers high- or low-order 32 bits of product.
Dn	Any Data Register n (example: D5 is data register 5)
Dr, Dq	Data register's remainder or quotient of divide.
Du	Data register D7–D0, used during update.
Dx, Dy	Source and destination data registers, respectively.
MRn	Any Memory Register n.

Table 1-4. Notational Conventions (Continued)

Rn	Any Address or Data Register
Rx, Ry	Any source and destination registers, respectively.
Xn	Index Register—An, Dn, or suppressed.
Data Format and Type	
+ inf	Positive Infinity
<fmt>	Operand Data Format: Byte (B), Word (W), Long (L), Single (S), Double (D), Extended (X), or Packed (P).
B, W, L	Specifies a signed integer data type (two's complement) of byte, word, or long word.
D	Double-precision real data format (64 bits).
k	A two's complement signed integer (−64 to +17) specifying a number's format to be stored in the packed decimal format.
P	Packed BCD real data format (96 bits, 12 bytes).
S	Single-precision real data format (32 bits).
X	Extended-precision real data format (96 bits, 16 bits unused).
− inf	Negative Infinity
Subfields and Qualifiers	
#<xxx> or #<data>	Immediate data following the instruction word(s).
()	Identifies an indirect address in a register.
{ }	Identifies an indirect address in memory.
bd	Base Displacement
d _n	Displacement Value, n Bits Wide (example: d ₁₆ is a 16-bit displacement).
LSB	Least Significant Bit
LSW	Least Significant Word
MSB	Most Significant Bit
MSW	Most Significant Word
od	Outer Displacement
SCALE	A scale factor (1, 2, 4, or 8, for no-word, word, long-word, or quad-word scaling, respectively).
SIZE	The index register's size (W for word, L for long word).
{offset:width}	Bit field selection.
Register Codes	
.	General Case.
C	Carry Bit in CCR
cc	Condition Codes from CCR
FC	Function Code
N	Negative Bit in CCR
U	Undefined, Reserved for Motorola Use.
V	Overflow Bit in CCR
X	Extend Bit in CCR
Z	Zero Bit in CCR
—	Not Affected or Applicable.
Miscellaneous	
<ea>	Effective Address
<label>	Assemble Program Label
<list>	List of registers, for example D3–D0.
LB	Lower Bound
m	Bit m of an Operand
m–n	Bits m through n of Operand
UB	Upper Bound



SECTION 2 SIGNAL DESCRIPTION

This section contains brief descriptions of the MC68060 signals in their functional groups (see Figure 2-1). Each signal's function is briefly explained, referencing other sections containing detailed information about the signal and related operations. Table 2-1 lists the MC68060 signal names, mnemonics, and functional descriptions of the signals. Timing specifications for these signals can be found in **Section 12 Electrical and Thermal Characteristics**.

NOTE

Assertion and *negation* are used to specify forcing a signal to a particular state. *Assertion* and *assert* refer to a signal that is active or true. *Negation* and *negate* refer to a signal that is inactive or false. These terms are used independently of the voltage level (high or low) that they represent.

Table 2-1. Signal Index

Signal Name	Mnemonic	Function
Address Bus	A31-A0	32-bit address bus used to address any of 4-Gbytes.
Cycle Long-Word Address	CLA	Controls the operation of A3 and A2 during bus cycles.
Data Bus	D31-D0	32-bit data bus used to transfer up to 32 bits of data per bus transfer.
Transfer Type	TT1,TT0	Indicates the general transfer type: normal, MOVE16, alternate logical function code, and acknowledge.
Transfer Modifier	TM2-TM0	Indicates supplemental information about the access.
Transfer Line Number	TLN1,TLN0	Indicates which cache line in a set is being pushed or loaded by the current line transfer cycle.
User-Programmable Attributes	UPA1,UPA0	User-defined signals, controlled by the corresponding user attribute bits from the address translation entry.
Read/Write	R/W	Identifies the transfer as a read or write.
Transfer Size	SIZ1,SIZ0	Indicates the data transfer size. These signals, together with A0 and A1, define the active sections of the data bus. Alternately, BS3-BS0 can be used for this function.
Bus Lock	LOCK	Indicates a bus cycle is part of a read-modify-write operation and that the sequence of bus cycles should not be interrupted.
Bus Lock End	LOCKE	Indicates the current bus cycle is the last in a locked sequence of bus cycles.
Cache Inhibit Out	CIOUT	Indicates the processor will not cache the current bus transfer information.
Byte Select	BS3-BS0	Indicate which bytes within a long word are selected and which data bus bytes are valid.
Transfer Start	TS	Indicates the beginning of a bus cycle.
Transfer in Progress	TIP	Asserted for the duration of a bus cycle.
Starting Termination Acknowledge Signal Sampling	SAS	Indicates the MC68060 will begin sampling the termination acknowledge signals.
Transfer Acknowledge	TA	Asserted to acknowledge a bus transfer.

Signal Description

Table 2-1. Signal Index (Continued)

Signal Name	Mnemonic	Function
Transfer Retry Acknowledge	TRA	Indicates the need to rerun the bus cycle.
Transfer Error Acknowledge	TEA	Indicates an error condition exists for a bus transfer.
Transfer Cycle Burst Inhibit	TBI	Indicates the slave cannot handle a line burst access.
Transfer Cache Inhibit	TCI	Indicates the current bus transfer should not be cached.
Snoop Control	SNOOP	Indicates the MC68060 should snoop bus activity while it is not the bus master.
Bus Request	BR	Asserted by the processor to request bus mastership.
Bus Grant	BG	Asserted by an arbiter to grant bus mastership privileges to the processor.
Bus Grant Relinquish Control	BGR	Qualifies BG by indicating the degree of necessity for relinquishing bus ownership when BG is negated.
Bus Tenure Termination	BTT	Indicates the MC68060 has relinquished the bus in response to the external arbiter's negation of BG.
Bus Busy	BB	Asserted by the current bus master to indicate it has assumed ownership of the bus.
Cache Disable	CDIS	Dynamically disables the internal caches to assist emulator support.
MMU Disable	MDIS	Disables the translation mechanism of the MMUs.
Reset In	RSTI	Processor reset.
Reset Out	RSTO	Asserted during execution of a RESET instruction to reset external devices.
Interrupt Priority Level	IPL2-IPL0	Provides an encoded interrupt level to the processor.
Interrupt Pending	IPEND	Indicates an interrupt is pending.
Autovector	AVEC	Used during an interrupt acknowledge transfer to request internal generation of the vector number.
Processor Status	PST4-PST0	Indicates internal processor status.
Processor Clock	CLK	Clock input used for all internal logic timing.
Clock Enable	CKEN	Defines the speed of the system bus clock to be full, 1/2, or 1/4 the speed of the processor clock.
JTAG Enable	JTAG	Selects between IEEE 1149.1 compliance operation and emulation mode operation.
Test Clock	TCK	Clock signal for the IEEE P1149.1 test access port (TAP).
Test Mode Select	TMS	Selects the principal operations of the test-support circuitry.
Test Data Input	TDI	Serial data input for the TAP.
Test Data Output	TDO	Serial data output for the TAP.
Test Reset	TRST	Provides an asynchronous reset of the TAP controller.
Thermal Resistor Connections	THERM1, THERM0	Provides thermal sensing information.
Power Supply	VCC	Power supply.
Ground	GND	Ground connection.

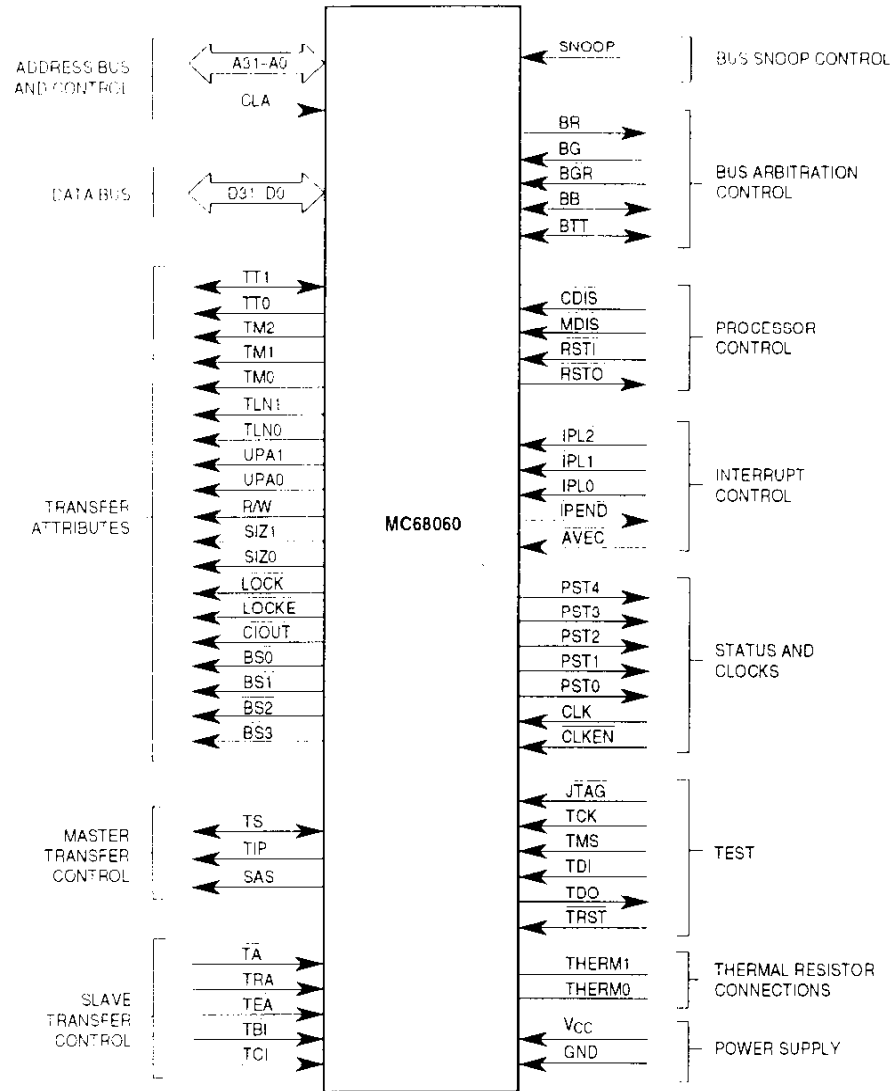

Figure 2-1. Functional Signal Groups

2.1 ADDRESS AND CONTROL SIGNALS

The following paragraphs describe the MC68060 address and control signals.

2.1.1 Address Bus (A31-A0)

These three-state bidirectional signals provide the address of the first item of a bus transfer (except for interrupt acknowledge transfers) when the MC68060 is the bus master. When an alternate bus master is controlling the bus and asserts the SNOOP signal, the address signals are examined to determine whether the processor should invalidate matching cache entries to maintain cache coherency.

Signal Description

2

2.1.2 Cycle Long-Word Address (\overline{CLA})

This active-low input signal controls the operation of A3 and A2 during bus cycles. Following each clock-enabled clock edge in which \overline{CLA} is asserted, the long-word address for each of the four transfers encoded on A3 and A2 will increment in a circular wraparound fashion. If \overline{CLA} is negated during a clock-enabled clock edge, the values on A3 and A2 will not change. It is not necessary to synchronize \overline{CLA} with \overline{TA} .

2.2 DATA BUS (D31–D0)

These three-state bidirectional signals provide the general-purpose data path between the MC68060 and all other devices. The data bus can transfer 8, 16, or 32 bits of data per bus transfer. During a burst bus cycle, the 128 bits of line information are transferred using four 32-bit transfers.

2.3 TRANSFER ATTRIBUTE SIGNALS

The following paragraphs describe the transfer attribute signals, which provide additional information about the bus transfer cycle. Refer to **Section 7 Bus Operation** for detailed information about the relationship of the transfer attribute signals to bus operation.

2.3.1 Transfer Cycle Type (TT1, TT0)

The processor drives these three-state signals to indicate the type of access for the current bus cycle. During bus cycle transfers by an alternate bus master when the processor is allowed to snoop bus transactions, TT1 is sampled. Only normal and MOVE16 accesses can be snooped. Table 2-2 lists the definition of the TTx encoding. The acknowledge access (TT1 = 1 and TT0 = 1) is used for interrupt acknowledge, breakpoint acknowledge, and low-power stop broadcast bus cycles.

Table 2-2. Transfer-Type Encoding

TT1	TT0	Transfer Type
0	0	Normal Access
0	1	MOVE16 Access
1	0	Alternate Logical Function Code Access, Debug Access
1	1	Acknowledge Access, Low-Power Stop Broadcast

2.3.2 Transfer Cycle Modifier (TM2–TM0)

These three-state outputs provide supplemental information for each transfer cycle type. Table 2-3 lists the encoding for normal (TTx = 00) and MOVE16 (TTx = 01) transfers, and Table 2-4 lists the encoding for alternate access transfers (TTx = 10). For interrupt acknowledge transfers, the TMx signals carry the interrupt level being acknowledged. For breakpoint acknowledge transfers and low-power stop broadcast cycles, the TMx signals are negated. When the MC68060 is not the bus master, the TMx signals are in a high-impedance state.

Table 2-3. Normal and MOVE16 Access TMx Encoding

TM2	TM1	TM0	Transfer Modifier
0	0	0	Data Cache Push Access
0	0	1	User Data Access*
0	1	0	User Code Access
0	1	1	MMU Table Search Data Access
1	0	0	MMU Table Search Code Access
1	0	1	Supervisor Data Access*
1	1	0	Supervisor Code Access
1	1	1	Reserved

*MOVE16 accesses use only these encodings.

Table 2-4. Alternate Access TMx Encoding

TM2	TM1	TM0	Transfer Modifier
0	0	0	Logical Function Code 0
0	0	1	Debug Access
0	1	0	Reserved
0	1	1	Logical Function Code 3
1	0	0	Logical Function Code 4
1	0	1	Debug Pipe Control Mode Access
1	1	0	Debug Pipe Control Mode Access
1	1	1	Logical Function Code 7

2.3.3 Transfer Line Number (TLN1, TLN0)

These three-state outputs indicate which line in the set of four data or instruction cache lines is being accessed for normal push and line data read accesses. TLNx signals are undefined for all other accesses and are placed in a high-impedance state when the processor is not the bus master.

The TLNx signals can be used in high-performance systems to build an external snoop filter with a duplicate set of cache tags. The TLNx signals and address bus provide a direct indication of the state of the data caches and can be used to help maintain the duplicate tag store. The TLNx signals do not indicate the correct TLN number when an instruction cache burst fill occurs.

2.3.4 User-Programmable Page Attributes (UPA1, UPA0)

The UPAx signals are three-state outputs. These signals are only valid for normal code, data, and MOVE16 accesses. For all other accesses (including table search and cache line push accesses), the UPAx signals are low. When the MC68060 is not the bus master, these signals are placed in a high-impedance state.

During normal and MOVE16 accesses, if a transparent translation register (TTR) is enabled and the address and attributes match the TTR values, the UPAx signals are defined by the logical values of the U1 and U0 bits the TTR. If the MMU is enabled via the translation control register (TCR) and the address and attributes result in an address translation cache (ATC) hit, the UPAx signals are defined by the logical values of the U1 and U0 bits in the ATC entry. If a given logical address is not mapped by the TTRs and if address translation is disabled,



Signal Description



then the MC68060 invokes default transparent translation. The cache mode, user page attributes, and other TTR fields for the default translation are defined by the contents of the TCR. For more information about the LIPAx signals, refer to **Section 4 Memory Management Unit**.

2.3.5 Read/Write ($\overline{R/\overline{W}}$)

This three-state output signal defines the data transfer direction for the current bus cycle. A high (logic one) level indicates a read cycle, and a low (logic zero) level indicates a write cycle. This signal is placed in a high-impedance state when the MC68060 is not the bus master.

2.3.6 Transfer Size (SIZ1, SIZ0)

These three-state output signals indicate the data size for the bus cycle. These signals are placed in a high-impedance state when the MC68060 is not the bus master. Table 2-5 shows the definitions of the SIZx encoding.

Table 2-5. SIZx Encoding

SIZ1	SIZ0	Transfer Size
0	0	Long Word (4 Bytes)
0	1	Byte
1	0	Word (2 Bytes)
1	1	Line (16 Bytes)

2.3.7 Bus Lock (\overline{LOCK})

This three-state output indicates that the current bus cycle is part of a sequence of locked bus cycles. An external arbiter can use \overline{LOCK} with its control of an alternate bus master's \overline{BG} to prevent an alternate bus master from gaining control of the bus and accessing the same operand between processor accesses for the locked sequence of transfers. Although \overline{LOCK} indicates that the processor requests that the bus be locked, the processor will relinquish the bus if the external arbiter negates \overline{BG} and asserts \overline{BGR} .

When the MC68060 is not the bus master, the \overline{LOCK} signal is set to a high-impedance state. If the MC68060 relinquishes the bus while \overline{LOCK} is asserted, \overline{LOCK} will be negated for one full clock-enabled clock cycle and then three-stated one clock-enabled clock cycle after the address bus is idled. If \overline{LOCK} was already negated in the clock cycle in which the MC68060 relinquishes the bus, it will be three-stated in the same clock cycle the address bus is idled.

Refer to **Section 7 Bus Operation** for information on locked transfers.

2.3.8 Bus Lock End (\overline{LOCKE})

This three-state output indicates that the current bus cycle is the last in a sequence of locked bus cycles (except in the case in which a retry termination is indicated on the last write of a read-modify-write sequence).

When the MC68060 is not the bus master, the \overline{LOCKE} signal is set to a high-impedance state. If the MC68060 relinquishes the bus while \overline{LOCKE} is asserted, \overline{LOCKE} will be negated

for one full BCLK cycle and then three-stated one BCLK cycle after the address bus is idled. If $\overline{\text{LOCKE}}$ was already negated in the BCLK cycle in which the MC68060 relinquishes the bus, it will be three-stated in the same BCLK cycle the address bus is idled.

$\overline{\text{LOCKE}}$ is provided to help make the MC68060 bus compatible with the MC68040-style bus protocol; however, for new designs, external bus arbitration logic can be simplified with the use of $\overline{\text{BGR}}$ instead of $\overline{\text{LOCKE}}$.

Do not use $\overline{\text{LOCKE}}$. The $\overline{\text{LOCKE}}$ protocol breaks the integrity of the locked read-modify-write sequence if it is possible to retry the last write of a read-modify-write operation. The reason is that when $\overline{\text{LOCKE}}$ is asserted, a bus arbiter can grant the bus to an alternate master when the current bus cycle is finished (before the retry is attempted). The bus is arbitrated away, the last write's retry is deferred until the bus is returned to the processor. In the meantime, the alternate master can access the same location where the write should have taken place. Hence, the integrity of the locked read-modify-write sequence is compromised in this situation.

2.3.9 Cache Inhibit Out ($\overline{\text{CIOUT}}$)

When asserted, this three-state output indicates that the MC68060 will not cache the current bus information in its internal caches. Refer to **Section 4 Memory Management Unit** for more information on $\overline{\text{CIOUT}}$ function. When the MC68060 is not the bus master, the $\overline{\text{CIOUT}}$ signal is placed in a high-impedance state.

2.3.10 Byte Select Lines ($\overline{\text{BS3}}\text{--}\overline{\text{BS0}}$)

These three-state outputs indicate which bytes within a long-word transfer are being selected and which bytes of the data bus will be used for the transfer. $\overline{\text{BS0}}$ refers to D31–D24, $\overline{\text{BS1}}$ refers to D23–D16, $\overline{\text{BS2}}$ refers to D15–D8, and $\overline{\text{BS3}}$ refers to D7–D0. These signals are generated to provide byte data select signals which are decoded from the SIZx, A1, and A0 signals as shown in Table 2-6. These signals are placed in a high-impedance state when the MC68060 is not the bus master.

Table 2-6. Data Bus Byte Select Signals

Transfer Size	SIZ1	SIZ0	A1	A0	$\overline{\text{BS0}}$	$\overline{\text{BS1}}$	$\overline{\text{BS2}}$	$\overline{\text{BS3}}$
					D31–D24	D23–D16	D15–D8	D7–D0
Byte	0	1	0	0	0	1	1	1
Byte	0	1	0	1	1	0	1	1
Byte	0	1	1	0	1	1	0	1
Byte	0	1	1	1	1	1	1	0
Word	1	0	0	0	0	0	1	1
Word	1	0	1	0	1	1	0	0
Long Word	0	0	x	x	0	0	0	0
Line	1	1	x	x	0	0	0	0

2.4 MASTER TRANSFER CONTROL SIGNALS

The following signals provide control functions for bus cycles when the MC68060 is the bus master. Refer to **Section 7 Bus Operation** for detailed information about the relationship of the bus cycle control signals to bus operation.

Signal Description

2

2.4.1 Transfer Start (\overline{TS})

The processor asserts this three-state bidirectional signal for one clock-enabled clock period to indicate the start of each bus cycle. During alternate bus master accesses, the processor monitors \overline{TS} and \overline{SNOOP} to detect the start of each bus cycle which is to be snooped. \overline{TS} is placed in a high-impedance state when the MC68060 is not the bus master. To properly maintain internal state information, all masters on the bus must have their \overline{TS} signals tied together.

2.4.2 Transfer in Progress (\overline{TIP})

This three-state output is asserted to indicate that a bus cycle is in progress and is negated during idle bus cycles if the bus is still granted to the processor. \overline{TIP} remains asserted during the time between back-to-back bus cycles.

If the MC68060 relinquishes the bus while \overline{TIP} is asserted, \overline{TIP} will be negated for one clock period after completion of the final transfer and then goes to a high-impedance state one clock period after the address is idled. Note that this one clock period in which \overline{TIP} is driven negated refers to an MC68060 processor clock period, not a full clock-enabled clock period. If \overline{TIP} was already negated in the clock period in which the MC68060 relinquishes the bus, it will be placed in a high-impedance state in the same clock period that the address bus becomes idle.

2.4.3 Starting Termination Acknowledge Signal Sampling (\overline{SAS})

This three-state output is asserted for one clock-enabled clock period to indicate that the MC68060 will begin sampling \overline{TA} , \overline{TEA} , \overline{TRA} , \overline{TBI} , \overline{TCI} , \overline{AVEC} , and spurious interrupt indication on the next rising edge of the clock-enabled clock. \overline{SAS} is negated at all other times while the MC68060 is the bus master. When the MC68060 relinquishes the bus, \overline{SAS} is driven negated for one clock-enabled clock period and then three-stated one clock-enabled clock period after the address bus is idled. When the MC68060 newly gains bus ownership and immediately starts a bus cycle with the assertion of \overline{TS} , \overline{SAS} remains three-stated until the clock-enabled clock period after \overline{TS} is asserted.

2.5 SLAVE TRANSFER CONTROL SIGNALS

The following signals provide control functions for bus transfers when the MC68060 is not the bus master. Refer to **Section 7 Bus Operation** for detailed information about the relationship of the bus cycle control signals to bus operation.

2.5.1 Transfer Acknowledge (\overline{TA})

This input indicates the completion of a requested data transfer operation. During transfers by the MC68060, \overline{TA} is an input signal from the referenced slave device indicating completion of the transfer. For the MC68060 to accept the transfer as successful with a transfer acknowledge, \overline{TRA} and \overline{TEA} must be negated when \overline{TA} is asserted.

2.5.2 Transfer Retry Acknowledge (\overline{TRA})

For native-MC68060-style (non-MC68040-style) acknowledge termination, this input signal may be asserted by the current slave on the first transfer of a bus cycle to indicate the need

to rerun the current bus cycle. The assertion of $\overline{\text{TR}\bar{\text{A}}}$ on any transfer other than the first transfer is ignored. The assertion of $\overline{\text{TR}\bar{\text{A}}}$ has precedence over $\overline{\text{T}\bar{\text{A}}}$, but does not have precedence over $\overline{\text{T}\bar{\text{E}}\bar{\text{A}}}$.

If the MC68060 processor is to be used with MC68040-style acknowledge termination, then $\overline{\text{TR}\bar{\text{A}}}$ must be held negated. In this case, $\overline{\text{T}\bar{\text{E}}\bar{\text{A}}}$ does not have precedence over $\overline{\text{T}\bar{\text{A}}}$ and the slave must assert both $\overline{\text{T}\bar{\text{E}}\bar{\text{A}}}$ and $\overline{\text{T}\bar{\text{A}}}$ on the first transfer of a bus cycle to cause a retry of the current bus cycle. The assertion of $\overline{\text{T}\bar{\text{E}}\bar{\text{A}}}$ and $\overline{\text{T}\bar{\text{A}}}$ on any transfer other than the first will be interpreted by the MC68060 as if only $\overline{\text{T}\bar{\text{E}}\bar{\text{A}}}$ had been asserted, which immediately terminates the bus cycle with a bus error indication.

2.5.3 Transfer Error Acknowledge ($\overline{\text{T}\bar{\text{E}}\bar{\text{A}}}$)

The current slave asserts this input signal to indicate an error condition for the current transfer to immediately terminate the bus cycle. The assertion of $\overline{\text{T}\bar{\text{E}}\bar{\text{A}}}$ has precedence over $\overline{\text{TR}\bar{\text{A}}}$ and $\overline{\text{T}\bar{\text{A}}}$ for native-MC68060-style acknowledgment termination.

For MC68040-style acknowledge termination, $\overline{\text{T}\bar{\text{E}}\bar{\text{A}}}$ must be asserted with $\overline{\text{T}\bar{\text{A}}}$ negated to cause the current bus cycle to immediately terminate with a bus error indication. For MC68040-style acknowledge termination, $\overline{\text{TR}\bar{\text{A}}}$ must be held negated.

2.5.4 Transfer Burst Inhibit ($\overline{\text{T}\bar{\text{B}}\bar{\text{I}}}$)

This input signal indicates to the processor that the device cannot support burst mode accesses and that the requested line transfer cycle should be divided into individual long-word bus cycles. Asserting $\overline{\text{T}\bar{\text{B}}\bar{\text{I}}}$ with $\overline{\text{T}\bar{\text{A}}}$ terminates the first data transfer of a line access, causing the processor to terminate the burst bus cycle and access the remaining data for the line as three successive long-word transfer cycles.

2.5.5 Transfer Cache Inhibit ($\overline{\text{T}\bar{\text{C}}\bar{\text{I}}}$)

This input signal inhibits line read data from being loaded into the MC68060 instruction or data caches. $\overline{\text{T}\bar{\text{C}}\bar{\text{I}}}$ is ignored during all writes and after the first data transfer for both burst line reads and burst-inhibited line reads. $\overline{\text{T}\bar{\text{C}}\bar{\text{I}}}$ is also ignored during all alternate bus master transfers.

2.6 SNOOP CONTROL ($\overline{\text{SNOOP}}$)

This input signal controls the operation of the MC68060 internal snoop logic. The MC68060 examines $\overline{\text{SNOOP}}$ when $\overline{\text{T}\bar{\text{S}}}$ is asserted by an alternate master controlling the bus. If snooping is disabled (i.e., $\overline{\text{SNOOP}}$ negated) during the clock when $\overline{\text{T}\bar{\text{S}}}$ is asserted, the MC68060 will not snoop the bus transaction. If snooping is enabled (i.e., $\overline{\text{SNOOP}}$ asserted) during the clock when $\overline{\text{T}\bar{\text{S}}}$ is asserted, the MC68060 will snoop the access and invalidate matching cache lines for either read or write bus cycles without any external indication that a cache entry has been invalidated upon cache snoop hits.

Section 5 Caches provides information about the relationship of $\overline{\text{SNOOP}}$ to the caches, and **Section 7 Bus Operation** discusses the relationship of $\overline{\text{SNOOP}}$ to bus operation.

2.7 ARBITRATION SIGNALS

The following control signals support bus mastership control by an external arbiter over the MC68060. Refer to **Section 7 Bus Operation** for detailed information about the relationship of the arbitration signals to bus operation.

2.7.1 Bus Request (\overline{BR})

This output signal indicates to an external arbiter that the processor needs to become bus master for one or more bus cycles. \overline{BR} is negated when the MC68060 begins an access to the external bus with no other internal accesses pending, and \overline{BR} remains negated until another internal request occurs. The assertion and negation of \overline{BR} are independent of bus activity and there are some situations in which the MC68060 asserts \overline{BR} and then negates it without having run a bus cycle; this is a disregard request condition. Refer to **Section 7 Bus Operation** for details about this state.

2.7.2 Bus Grant (\overline{BG})

This input signal from an external arbiter indicates that the bus is available to the MC68060 as soon as the current bus cycle completes. The MC68060 assumes bus ownership when \overline{BG} is asserted and \overline{BB} is negated, when \overline{BG} is asserted and a \overline{TS} - \overline{BTT} pair (\overline{TS} asserted, followed by \overline{BTT} asserted) has occurred in the past without another assertion of \overline{TS} , or when \overline{BG} and \overline{BTT} are asserted and \overline{TS} is negated. The MC68060 indicates its ownership of the bus by asserting \overline{BB} . When the external arbiter negates \overline{BG} , the MC68060 relinquishes the bus as soon as the current bus cycle is complete unless a locked sequence of bus cycles is in progress with \overline{BGR} negated. In this case, the MC68060 will complete the entire sequence of locked bus cycles and then indicate that it is relinquishing the bus by asserting \overline{BTT} and negating \overline{BB} .

2.7.3 Bus Grant Relinquish Control (\overline{BGR})

This input signal is a qualifier for \overline{BG} and indicates to the MC68060 the degree of necessity for relinquishing bus ownership when \overline{BG} is negated by an external arbiter. \overline{BGR} controls MC68060 behavior when \overline{BG} is negated during sequences of locked bus cycles (\overline{LOCK} asserted). When the external arbiter negates \overline{BG} during a series of locked bus cycles, the assertion of \overline{BGR} will cause the MC68060 to relinquish the bus on the last transfer of the current bus cycle, even though the MC68060 had intended the series to be locked. If \overline{BGR} remains negated when \overline{BG} is negated during locked transfers, then the MC68060 will not relinquish the bus until the series of locked bus cycles is complete.

2.7.4 Bus Tenure Termination (\overline{BTT})

This three-state bidirectional signal is asserted for one clock-enabled clock period and negated for one clock-enabled clock period to indicate that the MC68060 has relinquished its bus tenure following the negation of \overline{BG} by an external arbiter. At all other times, \overline{BTT} is in a high-impedance state. When an alternate master is controlling the bus, the MC68060 samples \overline{BTT} as an input to maintain internal state information and to monitor when the MC68060 may become the bus master. To properly maintain this internal state information, all masters on the bus must have their \overline{TS} signals tied together and their \overline{BTT} signals tied together so the MC68060 can keep track of \overline{TS} - \overline{BTT} pairs.

The MC68060 provides the \overline{BB} signal and protocol to provide compatibility with MC68040-style buses. Either the \overline{BTT} signal and protocol or the \overline{BB} signal and protocol (but not both) should be used. The unused signal, either \overline{BTT} or \overline{BB} , must be pulled up with a pullup resistor and tied to V_{CC} . Use of the \overline{BTT} signal and protocol yields higher performance at full bus speed and high operating frequencies. The use of \overline{BB} and its associated protocol is not recommended at full bus speeds. The \overline{BTT} protocol is discussed in detail in **Section 7 Bus Operation**.

2.7.5 Bus Busy (\overline{BB})

This three-state bidirectional signal indicates that the bus is currently owned. \overline{BB} is monitored as a processor input to determine when an alternate bus master has released control of the bus. The MC68060 samples bus availability on each clock-enabled clock edge. \overline{BG} must be asserted and both \overline{TS} and \overline{BB} must be negated (indicating the bus is free) before the MC68060 asserts \overline{BB} (with the first assertion of \overline{TS}) as an output to assume ownership of the bus. The processor keeps \overline{BB} asserted until the external arbiter negates \overline{BG} and the processor completes the bus cycle in progress. When releasing the bus, the processor negates \overline{BB} for one clock period, then places it in a high-impedance state and begins to sample it as an input. Note that the one clock period in which \overline{BB} is negated is one MC68060 processor clock period, not a full clock-enabled clock period.

The MC68060 provides the \overline{BB} signal and protocol to support compatibility with MC68040-style buses. Either the \overline{BTT} signal and protocol or the \overline{BB} signal and protocol (but not both) should be used. The unused signal, either \overline{BTT} or \overline{BB} , must be pulled up through a pullup resistor and tied to V_{CC} . Use of the \overline{BTT} signal and protocol yields higher performance at full bus speed and high operating frequencies. The use of \overline{BB} and its associated protocol is not recommended at full bus speeds. The \overline{BTT} protocol is discussed in detail in **Section 7 Bus Operation**.

2.8 PROCESSOR CONTROL SIGNALS

The following signals control the caches and MMUs and support processor and external device initialization.

2.8.1 Cache Disable (\overline{CDIS})

When asserted, this input signal dynamically disables the on-chip caches on the next internal cache access boundary. The caches are enabled on the next boundary after \overline{CDIS} is negated.

\overline{CDIS} does not flush the data and instruction caches. Cache entries remain unaltered and become available after \overline{CDIS} is negated, unless one of the cache invalidate instructions (CINVA, CINVP, CINVL) are executed. The execution of one of the cache invalidate instructions may invalidate entries even if the caches have been disabled with this signal. The assertion of \overline{CDIS} does not affect snooping.

Refer to **Section 5 Caches** for information about the caches.

Signal Description

2

2.8.2 MMU Disable ($\overline{\text{MDIS}}$)

When asserted, this input signal dynamically disables the MC68060 internal operand data and instruction MMUs on the next internal access boundary. While $\overline{\text{MDIS}}$ is asserted, all accesses bypass the MMU ATCs, and thus translate transparently. The execution of one of the MMU flush instructions (PFLUSHA, PFLUSHAN, PFLUSH, PFLUSHN) may cause the deletion of the MMU entries, even if the MMU has been disabled by this signal. The MMUs are enabled on the next boundary after $\overline{\text{MDIS}}$ is negated. Refer to **Section 4 Memory Management Unit** for a description of address translation.

2.8.3 Reset In ($\overline{\text{RSTI}}$)

The assertion of this input signal causes the MC68060 to enter reset exception processing. The $\overline{\text{RSTI}}$ signal is an asynchronous input that is internally synchronized to the next rising clock-enabled clock (CLK) edge. All three-state signals will eventually be set to the high-impedance state when $\overline{\text{RSTI}}$ is recognized. The assertion of $\overline{\text{RSTI}}$ does not affect the test pins. Refer to **Section 7 Bus Operation** for a description of reset operation and to **Section 8 Exception Processing** for information about the reset exception.

2.8.4 Reset Out ($\overline{\text{RSTO}}$)

The MC68060 asserts this output during execution of the RESET instruction to initialize external devices. All bus cycles by the MC68060 are suspended prior to the assertion of $\overline{\text{RSTO}}$, but bus arbitration and snooping still function. Refer to **Section 7 Bus Operation** for a description of reset out bus operation.

2.9 INTERRUPT CONTROL SIGNALS

The following signals control the interrupt functions.

2.9.1 Interrupt Priority Level ($\overline{\text{IPL2}}\text{--}\overline{\text{IPL0}}$)

These input signals provide an indication of an interrupt condition with the interrupt level from a peripheral or external prioritizing circuitry encoded. $\overline{\text{IPL2}}$ is the most significant bit of the level number. For example, since the $\overline{\text{IPLx}}$ signals are active low, $\overline{\text{IPL2}}\text{--}\overline{\text{IPL0}} = 101$ corresponds to an interrupt request at interrupt priority level 2. $\overline{\text{IPL2}}\text{--}\overline{\text{IPL0}} = 000$ (level 7) is the highest priority interrupt and cannot be internally masked. $\overline{\text{IPL2}}\text{--}\overline{\text{IPL0}} = 111$ (level 0) indicates no interrupt is requested. The $\overline{\text{IPLx}}$ signals are asynchronous inputs that are internally synchronized to rising clock (CLK) edges.

During a processor reset, the levels on the $\overline{\text{IPLx}}$ lines are registered and used to configure the various operating modes for the MC68060 bus. Refer to **Section 7 Bus Operation** for more information on bus operating modes and **Section 8 Exception Processing** for information on interrupts.

2.9.2 Interrupt Pending Status ($\overline{\text{IPEND}}$)

This output signal indicates that an interrupt request has been recognized internally by the processor and exceeds the current interrupt priority mask in the status register (SR). External devices (other bus masters) can use $\overline{\text{IPEND}}$ to predict processor operation on the next instruction boundaries. $\overline{\text{IPEND}}$ is not intended for use as an interrupt acknowledge to exter-

nal peripheral devices. Refer to **Section 7 Bus Operation** for bus information related to interrupts and to **Section 8 Exception Processing** for interrupt information.

2.9.3 Autovector (\overline{AVEC})

This input signal is asserted with \overline{TA} during an interrupt acknowledge bus cycle to request internal generation of the vector number. Refer to **Section 7 Bus Operation** for more information about automatic vectors.

2.10 STATUS AND CLOCK SIGNALS

The following paragraphs describe the signals that provide timing and the internal processor status.

2.10.1 Processor Status (PST4–PST0)

These outputs indicate the internal execution unit status. The timing is synchronous with the MC68060 processor clock (CLK), and the status may have nothing to do with the current bus transfer. Table 2-7 lists the definition of the PSTx encodings.

The encodings \$16, \$17, and \$1C indicate the present status and do not reflect a specific stage of the pipe. These encodings persist as long as the processor stays in the indicated state. The default encoding \$00 is indicated if none of the above conditions apply. Most other encodings indicate that the instruction is in its last instruction execution stage. These encodings exist for only one CLK period per instruction and are mutually exclusive.

In general, the PSTx bits indicate the following information:

- PST4 = Supervisor Mode
- PST3 = Branch Instruction
- PST2 = Taken Branch Instruction
- PST1, PST0 = Number of Instructions Completed that Cycle

Signal Description

Table 2-7. PSTx Encoding

Hex	PST4	PST3	PST2	PST1	PST0	Internal Processor Status
\$00	0	0	0	0	0	Continue Execution in User Mode
\$01	0	0	0	0	1	Complete 1 Instruction in User Mode
\$02	0	0	0	1	0	Complete 2 Instructions in User Mode
\$03	0	0	0	1	1	---
\$04	0	0	1	0	0	---
\$05	0	0	1	0	1	---
\$06	0	0	1	1	0	---
\$07	0	0	1	1	1	---
\$08	0	1	0	0	0	Emulator Mode Entry Exception Processing
\$09	0	1	0	0	1	Complete Not Taken Branch in User Mode
\$0A	0	1	0	1	0	Complete Not Taken Branch Plus 1 Instruction in User Mode
\$0B	0	1	0	1	1	IED Cycle of Branch to Vector, Emulator Entry Exception
\$0C	0	1	1	0	0	---
\$0D	0	1	1	0	1	Complete Taken Branch in User Mode
\$0E	0	1	1	1	0	Complete Taken Branch Plus 1 Instruction in User Mode
\$0F	0	1	1	1	1	Complete Taken Branch Plus 2 Instructions in User Mode
\$10	1	0	0	0	0	Continue Execution in Supervisor Mode
\$11	1	0	0	0	1	Complete 1 Instruction in Supervisor Mode
\$12	1	0	0	1	0	Complete 2 Instructions in Supervisor Mode
\$13	1	0	0	1	1	---
\$14	1	0	1	0	0	---
\$15	1	0	1	0	1	Complete RTE Instruction in Supervisor Mode
\$16	1	0	1	1	0	Low-Power Stopped State; Waiting for an Interrupt or Reset
\$17	1	0	1	1	1	MC68060 Is Stopped Waiting for an Interrupt
\$18	1	1	0	0	0	MC68060 Is Processing an Exception
\$19	1	1	0	0	1	Complete Not Taken Branch in Supervisor Mode
\$1A	1	1	0	1	0	Complete Not Taken Branch Plus 1 Instruction in Supervisor Mode
\$1B	1	1	0	1	1	IED Cycle of Branch to Vector, Exception Processing
\$1C	1	1	1	0	0	MC68060 Is Halted
\$1D	1	1	1	0	1	Complete Taken Branch in Supervisor Mode
\$1E	1	1	1	1	0	Complete Taken Branch Plus 1 Instruction in Supervisor Mode
\$1F	1	1	1	1	1	Complete Taken Branch Plus 2 Instructions in Supervisor Mode

2.10.2 MC68060 Processor Clock (CLK)

CLK is the synchronous clock of the MC68060. This signal is used internally to clock or sequence the internal logic of the MC68060 processor and is qualified with $\overline{\text{CLKEN}}$ to clock all external bus signals.

Since the MC68060 is designed for static operation, CLK can be gated off to lower power dissipation (e.g., during low-power stopped states). Refer to **Section 7 Bus Operation** for more information on low-power stopped states.

2.10.3 Clock Enable ($\overline{\text{CLKEN}}$)

This input signal is a qualifier for the MC68060 processor clock (CLK) and is provided to support lower bus frequency MC68060 designs. The internal MC68060 bus interface controller will sample, assert, negate, or three-state signals (except for $\overline{\text{BB}}$ and $\overline{\text{TIP}}$ which can three-

state on the rising edge of CLK regardless of the state of the $\overline{\text{CLKEN}}$ only on those rising edges of CLK which are spanned by the assertion of $\overline{\text{CLKEN}}$.

$\overline{\text{CLKEN}}$ may be used to allow the external bus to run at 1/2 or 1/4 the speed of the MC68060 processor clock which controls all internal operations. The MC68060 bus interface controller will not detect those rising edges of CLK which are spanned with the negation of $\overline{\text{CLKEN}}$. To operate the external bus at 1/2 or 1/4 the speed of CLK, $\overline{\text{CLKEN}}$ must be asserted and stable during the rising edges of CLK which coincide with the system clock running at 1/2 or 1/4 the frequency of the MC68060 processor clock. $\overline{\text{CLKEN}}$ must be negated and stable during all other rising CLK edges.

For full speed operation of the MC68060 processor, $\overline{\text{CLKEN}}$ must be continuously asserted.

Refer to **Section 7 Bus Operation** for more information on the MC68060 bus interface and controller. Refer to **Section 12 Electrical and Thermal Characteristics** for the timing specifications of CLK and $\overline{\text{CLKEN}}$.

2.11 TEST SIGNALS

The MC68060 includes dedicated user-accessible test logic that is fully compatible with the *IEEE 1149.1 Standard Test Access Port and Boundary Scan Architecture*. Problems associated with testing high-density circuit boards have led to the development of this standard under the IEEE Test Technology Committee and Joint Test Action Group (JTAG) sponsorship. The MC68060 implementation supports circuit board test strategies based on this standard. However, the JTAG interface is not intended to provide an in-circuit test to verify MC68060 operations; therefore, it is impossible to test MC68060 operations using this interface. **Section 9 IEEE 1149.1 Test (JTAG) and Debug Pipe Control Modes** describes the MC68060 implementation of IEEE 1149.1 and is intended to be used with the supporting IEEE document.

2.11.1 JTAG Enable ($\overline{\text{JTAG}}$)

This input signal is used to select between 1149.1 operation and debug emulation mode. The 1149.1 test access port (TAP) pins are remapped to emulation mode functions when this pin is negated. For normal 1149.1 operation, $\overline{\text{JTAG}}$ should be grounded.

2.11.2 Test Clock (TCK)

This input signal is used as a dedicated clock for the test logic. Since clocking of the test logic is independent of the normal operation of the MC68060, several other components on a board can share a common test clock with the processor even though each component may operate from a different system clock. The design of the test logic allows the test clock to run at low frequencies, or to be gated off entirely as required for test purposes. TCK should be grounded if it is not used and emulation mode is not to be used.

2.11.3 Test Mode Select (TMS)

This input signal is decoded by the TAP controller and distinguishes the principal operations of the test support circuitry. TMS should be tied to V_{CC} if it is not used and emulation mode is not to be used.

Signal Description

2

2.11.4 Test Data In (TDI)

This input signal provides a serial data input to the TAP. TDI should be tied to V_{CC} if it is not used and emulation mode is not to be used.

2.11.5 Test Data Out (TDO)

This three-state output signal provides a serial data output from the TAP. The TDO output can be placed in a high-impedance mode to allow parallel connection to board-level test data paths.

2.11.6 Test Reset (\overline{TRST})

This input signal provides an asynchronous reset of the TAP controller. \overline{TRST} should be grounded if 1149.1 operation is not to be used.

2.12 THERMAL SENSING PINS (THERM1, THERM0)

THERM1 and THERM0 are connected to an internal thermal resistor and provide information about the average temperature of the die. The resistance across these two pins is proportional to the average temperature of the die. The temperature coefficient of the resistor is approximately $1.2 \Omega/^\circ\text{C}$ with a nominal resistance of 400Ω at 25°C .

2.13 POWER SUPPLY CONNECTIONS

The MC68060 requires connection to a V_{CC} power supply, positive with respect to ground. The V_{CC} and ground connections are grouped to supply adequate current to the various sections of the processor. **Section 13 Ordering Information and Mechanical Data** describes the groupings of the V_{CC} and ground connections.

2.14 SIGNAL SUMMARY

Table 2-8 provides a summary of the electrical characteristics of the MC68060 signals.

Table 2-8. Signal Summary

Signal Name	Mnemonic	Input/Output	Active State	Three-State	Reset State
Address Bus	A31-A0	Input/Output	High	Yes	Three-Stated
Cycle Long-Word Address	CLA	Input	Low	—	—
Data Bus	D31-D0	Input/Output	High	Yes	Three-Stated
Transfer Type 1	TT1	Input/Output	High	Yes	Three-Stated
Transfer Type 0	TT0	Output	High	Yes	Three-Stated
Transfer Modifier	TM2-TM0	Output	High	Yes	Three-Stated
Transfer Line Number	TLN1, TLN0	Output	High	Yes	Three-Stated
User-Programmable Attributes	UPA1, UPA0	Output	High	Yes	Three-Stated
Read/Write	R/W	Output	High/Low	Yes	Three-Stated
Transfer Size	SIZ1, SIZ0	Output	High	Yes	Three-Stated
Bus Lock	LOCK	Output	Low	Yes	Three-Stated
Bus Lock End	LOCKE	Output	Low	Yes	Three-Stated
Cache Inhibit Out	CIOUT	Output	Low	Yes	Three-Stated
Byte Select	BS3-BS0	Output	Low	Yes	Three-Stated
Transfer Start	TS	Input/Output	Low	Yes	Three-Stated
Transfer in Progress	TIP	Output	Low	Yes	Three-Stated
Starting Termination Acknowledge Signal Sampling	SAS	Output	Low	Yes	Three-Stated
Transfer Acknowledge	TA	Input	Low	—	—
Transfer Retry Acknowledge	TRA	Input	Low	—	—
Transfer Error Acknowledge	TEA	Input	Low	—	—
Transfer Burst Inhibit	TBI	Input	Low	—	—
Transfer Cache Inhibit	TCI	Input	Low	—	—
Snoop Control	SNOOP	Input	Low	—	—
Bus Request	BR	Output	Low	No	Negated
Bus Grant	BG	Input	Low	—	—
Bus Grant Relinquish Control	BGR	Input	Low	—	—
Bus Busy	BB	Input/Output	Low	Yes	Three-Stated
Bus Tenure Termination	BTT	Input/Output	Low	Yes	Three-Stated
Cache Disable	CDIS	Input	Low	—	—
MMU Disable	MDIS	Input	Low	—	—
Reset In	RSTI	Input	Low	—	—
Reset Out	RSTO	Output	Low	No	Negated
Interrupt Priority Level	IPL2-IPL0	Input	Low	—	—
Interrupt Pending	IPEND	Output	Low	No	Negated
Autovector	AVEC	Input	Low	—	—
Processor Status	PST4-PST0	Output	High	No	10000
Processor Clock	CLK	Input	—	—	—
Clock Enable	CLKEN	Input	Low	—	—
JTAG Enable	JTAG	Input	Low	—	—
Test Clock	TCK	Input	—	—	—
Test Mode Select	TMS	Input	High	—	—
Test Data Input	TDI	Input	High	—	—
Test Data Output	TDO	Output	High	Yes	Three-Stated
Test Reset	TRST	Input	Low	—	—
Thermal Resistor Connections	THERM1, THERM0	—	—	—	—
Power Supply	VCC	Input	—	—	—
Ground	GND	Input	—	—	—



SECTION 3 INTEGER UNIT

This section describes the organization of the MC68060 integer unit and presents a brief description of the associated registers. Refer to **Section 4 Memory Management Unit** for details concerning the paged memory management unit (MMU) programming model and to **Section 6 Floating-Point Unit** for details concerning the floating-point unit (FPU) programming model.

3.1 INTEGER UNIT EXECUTION PIPELINES

The MC68060 integer unit execution pipelines are four-stage pipelines which perform final instruction decode, effective address calculation, and execution or integer operations. The operand execution pipelines (OEPs) are referred to individually as the primary OEP (pOEP) and the secondary OEP (sOEP). Figure 3-1 shows the integer unit of the MC68060.

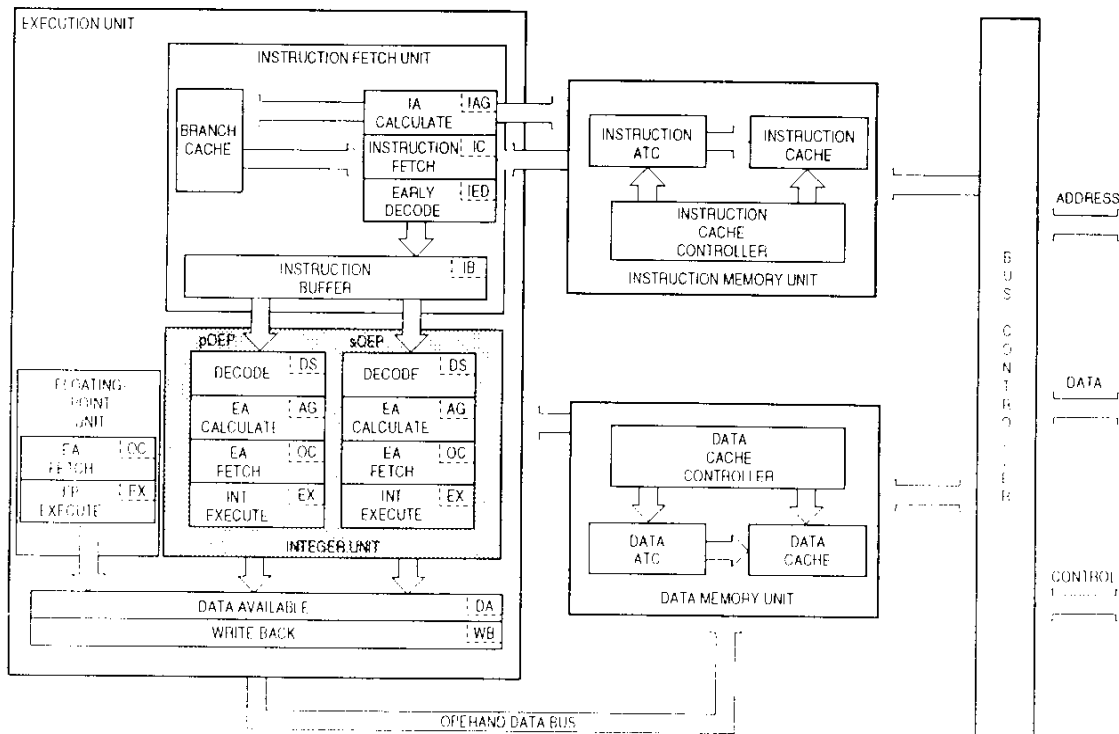

Figure 3-1. MC68060 Integer Unit Pipeline

Integer Unit

3

The operation of the instruction fetch unit (IFU) and the OEPs are decoupled by a 96-byte FIFO instruction buffer. The IFU prefetches instructions every processor clock cycle, stopping only if the instruction buffer is full or encountering a wait condition due to instruction fetch address translation or cache miss. The OEPs attempt to read instructions from the instruction buffer and execute them every clock cycle, stopping only if full instruction information is not present in the buffer or due to operand pipeline wait conditions.

3.2 INTEGER UNIT REGISTER DESCRIPTION

The following paragraphs describe the integer unit registers in the user and supervisor programming models. Refer to **Section 4 Memory Management Unit** for details on the MMU programming model and **Section 6 Floating-Point Unit** for details on the FPU programming model.

3.2.1 Integer Unit User Programming Model

Figure 3-2 illustrates the integer unit portion of the user programming model. The model is the same as for previous M68000 family microprocessors, consisting of the following registers:

- 16 General-Purpose 32-Bit Registers (D7–D0, A7–A0)
- 32-Bit Program Counter (PC)
- 8-Bit Condition Code Register (CCR)

3.2.1.1 DATA REGISTERS (D7–D0). Registers D7–D0 are used as data registers for bit and bit field (1- to 32-bit), byte (8-bit), word (16-bit), long-word (32-bit), and quad-word (64-bit) operations. These registers may also be used as index registers.

3.2.1.2 ADDRESS REGISTERS (A6–A0). These registers can be used as software stack pointers, index registers, or base address registers. The address registers may be used for word and long-word operations.

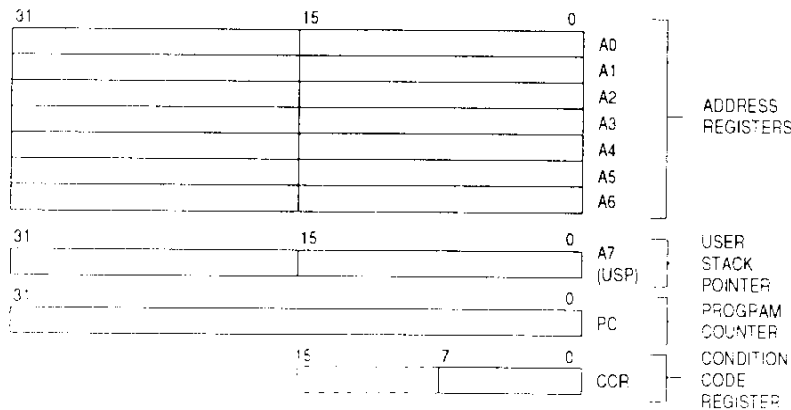

Figure 3-2. Integer Unit User Programming Model

3.2.1.3 USER STACK POINTER (A7). A7 is used as a hardware stack pointer during implicit or explicit stacking for subroutine calls and exception handling. The register designation A7 refers to the user stack pointer (USP) in the user programming model and to the

supervisor stack pointer (SSP) in the supervisor programming model. When the S-bit in the status register (SR) is clear, the USP is the active stack pointer.

A subroutine call saves the program counter (PC) on the active system stack, and the return restores the PC from the active system stack. Both the PC and the SR are saved on the supervisor stack during the processing of exceptions and interrupts. Thus, the execution of supervisor level code is independent of user code and the condition of the user stack. Conversely, user programs use the USP independently of supervisor stack requirements.



3.2.1.4 PROGRAM COUNTER. The PC contains the address of the currently executing instruction. During instruction execution and exception processing, the processor automatically increments the contents of the PC or places a new value in the PC, as appropriate. For some addressing modes, the PC can be used as a pointer for PC-relative addressing.

3.2.1.5 CONDITION CODE REGISTER. The CCR is the least significant byte of the processor SR. Bits 3–0 represent a condition of a result generated by a processor operation. Bit 4, the extend bit (X-bit), is an operand for multiprecision computations. The carry bit (C-bit) and the X-bit are separate in the M68000 family to simplify programming techniques that use them.

3.2.2 Integer Unit Supervisor Programming Model

Only system programmers use the supervisor programming model (see Figure 3-3) to implement sensitive operating system functions, I/O control, and MMU subsystems. All accesses that affect the control features of the MC68060 are in the supervisor programming model. Thus, all application software is written to run in the user mode and migrates to the MC68060 from any M68000 platform without modification.

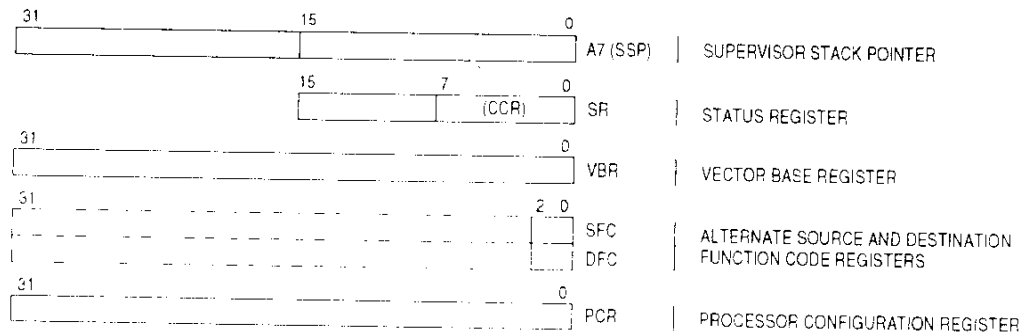

Figure 3-3. Integer Unit Supervisor Programming Model

Integer Unit

The supervisor programming model consists of the registers available to the user as well as the following control registers:

- 32-Bit Supervisor Stack Pointer (SSP, A7)
- 16-Bit Status Register (SR)
- 32-Bit Vector Base Register (VBR)
- Two 32-Bit Alternate Function Code Registers: Source Function Code (SFC) and Destination Function Code (DFC)
- 32-Bit Processor Configuration Register (PCR)

The following paragraphs describe the supervisor programming model registers. Additional information on the SSP, SR, and VBR registers can be found in **Section 8 Exception Processing**.

3.2.2.1 SUPERVISOR STACK POINTER. When the MC68060 is operating at the supervisor level, instructions that use the system stack implicitly, or access address register A7 explicitly, use the SSP. The SSP is a general-purpose register and can be used as a software stack pointer, index register, or base address register. The SSP can be used for word and long-word operations. The initial value of the SSP is loaded from the reset exception vector, address offset 0.

3.2.2.2 STATUS REGISTER. The SR (see Figure 3-4) stores the processor status and includes the CCR, the interrupt priority mask, and other control bits. In the supervisor mode, software can access the entire SR. The control bits indicate the following states for the processor: trace mode (T-bit), supervisor or user mode (S-bit), and master or interrupt state (M).

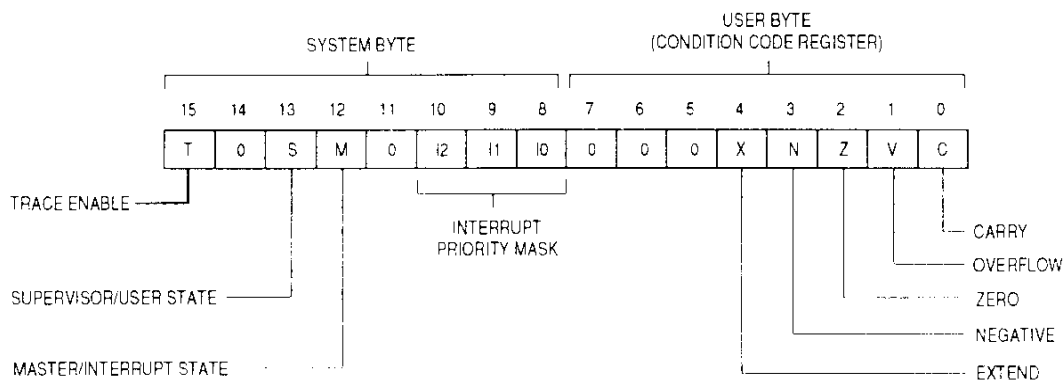

Figure 3-4. Status Register

3.2.2.3 VECTOR BASE REGISTER. The VBR contains the base address of the exception vector table in memory. The displacement of an exception vector is added to the value in this register to access the vector table. Refer to **Section 8 Exception Processing** for information on exception vectors.

3.2.2.4 ALTERNATE FUNCTION CODE REGISTERS. The alternate function code registers contain 3-bit function codes. Function codes can be considered extensions of the 32-bit logical address that optionally provides as many as eight 4-Gbyte address spaces. The processor automatically generates function codes to select address spaces for data and programs at the user and supervisor modes. Certain instructions use the SFC and DFC registers to specify the function codes for operations.

3.2.2.5 PROCESSOR CONFIGURATION REGISTER. The PCR is an 32-bit register which controls the operations of the MC68060 internal pipelines and contains a software readable revision number. The PCR is shown in Figure 3-5.

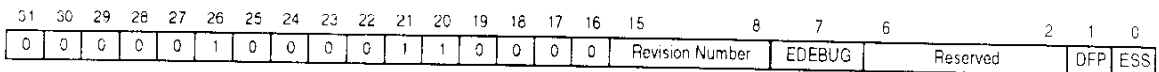

Figure 3-5. Processor Configuration Register

Bits 31–16—Identification

These bits are configured with the value which identifies this device as an MC68060. These bits are ignored when writing to the PCR.

See **Appendix A MC68LC060** and **Appendix B MC68EC060** for MC68LC060 and MC68EC060, respectively, identification field values.

Bits 15–8—Revision Number

Bits 15–8 contain the 8-bit device revision number. The first revision is 00000000. These bits are ignored when writing to the PCR.

EDEBUG—Enable Debug Features

When this bit is set, the MC68060 outputs internal control information on the address bus (A31–A0) and data bus (D31–D0) during idle bus cycles. This capability is implemented to support debug of designs that include the MC68060. When this bit is cleared, operation proceeds in a normal manner and no internal information is output on idle bus cycles. This bit is cleared at reset.

Bits 6–2—Reserved by Motorola for future use and must always be zero.

DFP—Disable Floating-Point Unit

When this bit is set, the on-chip FPU is disabled and any attempt to execute a floating-point instruction generates a line F emulator exception. When this bit is cleared, the FPU executes all floating-point instructions. This bit is cleared at reset. Note that before this bit is set via the MOVEC instruction, an FNOP must be executed to ensure that all floating-point exceptions are caught and handled. This would prevent unexpected floating-point related exceptions to be reported when the FPU is re-enabled at a later time.

ESS—Enable Superscalar Dispatch

When this bit is set, the ability of the MC68060 to execute multiple instructions per machine cycle is enabled. When this bit is cleared, the ability to execute multiple instructions per cycle is disabled and the MC68060 operates at a slower rate with lower performance. This bit is cleared at reset.

SECTION 4 MEMORY MANAGEMENT UNIT

NOTE

This section does not apply to the MC68EC060. Refer to **Appendix B MC68EC060** for details.

The MC68060 supports a demand-paged virtual memory environment. Demand means that programs request permission to use memory area by accessing logical addresses, and paged means that memory is divided into blocks of equal size, called page frames. Each page frame is divided into pages of the same size. The operating system assigns pages to page frames as they are required to meet the needs of the program.

The MC68060 memory management includes the following features:

- Independent Instruction and Data Memory Management Units (MMUs)
- 32-Bit Logical Address Translation to 32-Bit Physical Address
- User-Defined 2-Bit Physical Address Extension
- Addresses Translated in Parallel with Indexing into Data or Instruction Cache
- 64-Entry Four-Way Set-Associative Address Translation Cache (ATC) for Each MMU (128 Total Entries)
- Global Bit Allowing Flushes of All Nonglobal Entries from ATCs
- Selectable 4- or 8-Kbyte Page Size
- Separate Supervisor and User Translation Tables
- Two Independent Blocks for Each MMU Can Be Defined as Transparent (Untranslated)
- Three-Level Translation Tables with Optional Indirection
- Supervisor and Write Protections
- History Bits Automatically Maintained in Descriptors
- External Translation Disable Input Signal ($\overline{\text{MDIS}}$) for Emulator Support
- Caching Mode Selected on Page Basis
- Default Transparent Translation
- Default Cache Mode and User Attributes

The MMUs completely overlap address translation time with other processing activities when the translation is resident in the corresponding ATC. ATC accesses operate in parallel with indexing into the on-chip instruction and data caches. The MMU $\overline{\text{MDIS}}$ signal dynamically disables address translation for emulation and diagnostic support.

Memory Management Unit

Figure 4-1 illustrates the MMUs contained in the two memory units, one for instructions (supporting instruction prefetches) and one for data (supporting all other accesses). Each MMU contains a 64-entry ATC, two transparent translation registers (TTRs), and control logic. The ATCs hold recently used logical to physical address translations, cache mode and protection information, and whether or not the page has been written. The TTRs are used for defining the cache modes, enabling protection modes and defining user page attributes for large regions of untranslated address space. Each MMU also allows enabling a default cache mode, protection, and user page attributes for address regions not covered by the ATC or TTRs.

4

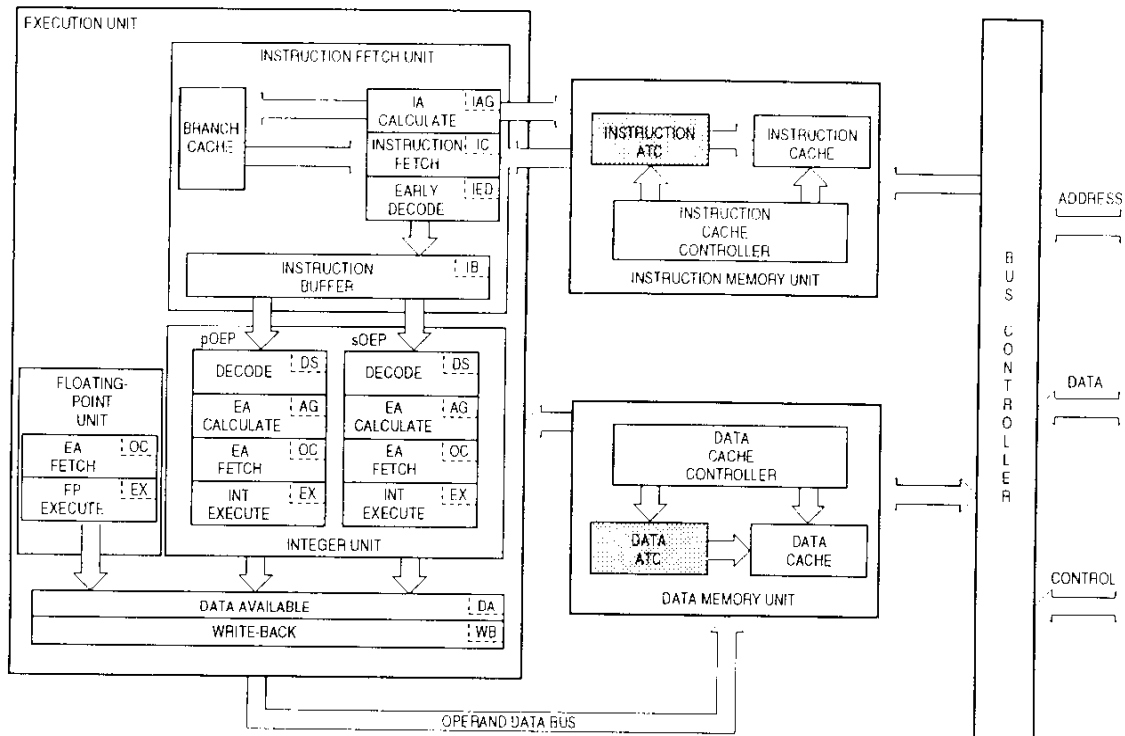

Figure 4-1. Memory Management Unit

One of the principal functions of the MMU is to provide logical to physical address translation using translation tables stored in memory. As an MMU receives a request from the corresponding pipe unit, its ATC is searched for the translation, using the upper logical address bits as a tag. If the translation is resident (or one of the TTRs hit causing transparent translation), the MMU provides the physical address for the corresponding cache lookup. If the translation is not in the ATC (and the TTRs miss), then a table search is done using translation tables stored in memory. When the translation is obtained, it is used for the cache lookup, and is placed in the ATC for future use. The table search is performed automatically by the MC68060 using on-chip logic.

4.1 MEMORY MANAGEMENT PROGRAMMING MODEL

The memory management programming model is part of the supervisor programming model for the MC68060. The seven registers that control and provide status information for address translation in the MC68060 are: the user root pointer register (URP), the supervisor root pointer register (SRP), the translation control register (TCR), and four independent transparent translation registers (ITTR0, ITTR1, DTTR0, and DTTR1). Only programs that execute in the supervisor mode can directly access these registers. Figure 4-2 illustrates the memory management programming model.

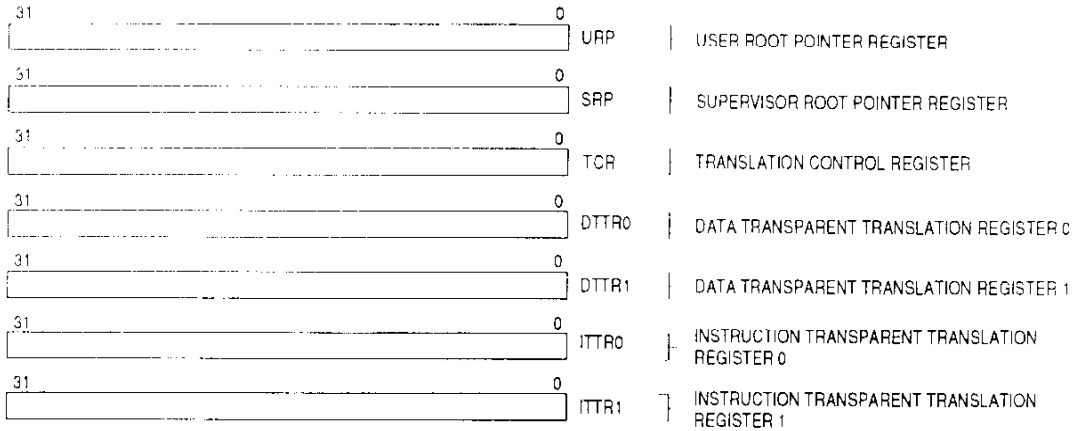

Figure 4-2. Memory Management Programming Model

4.1.1 User and Supervisor Root Pointer Registers

The SRP and URP registers each contain the physical address of the translation table's root, which the MMU uses for supervisor and user accesses, respectively. The URP points to the translation table for the current user task. When a new task begins execution, the operating system typically writes a new root pointer to the URP. A new translation table address implies that the contents of the ATCs may no longer be valid. Writing a root pointer register does not affect the contents of the ATCs. A PFLUSH instruction should be executed to flush the ATCs before loading a new root pointer value, if necessary. Figure 4-3 illustrates the format of the 32-bit URP and SRP registers. Bits 8–0 of an address loaded into the URP or the SRP must be zero. Transfers of data to and from these 32-bit registers are long-word transfers.

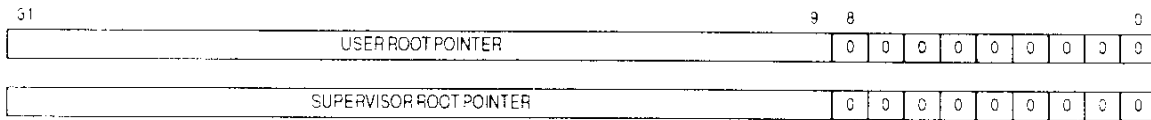

Figure 4-3. URP and SRP Register Formats

4.1.2 Translation Control Register

The 32-bit TCR contains control bits which select translation properties. The operating system must flush the ATCs before enabling address translation since the TCR accesses and reset do not flush the ATCs. All unimplemented bits of this register are read as zeros and must always be written as zeros. The MC68060 always uses long-word transfers to access this 32-bit register. All bits are cleared by reset. Figure 4-4 illustrates the TCR.

4

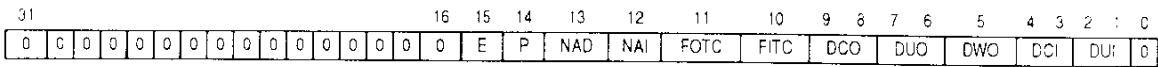

Figure 4-4. Translation Control Register Format

Bits 31–16—Reserved by Motorola. Always read as zero.

E—Enable

This bit enables and disables paged address translation.

- 0 = Disable
- 1 = Enable

A reset operation clears this bit. When translation is disabled, logical addresses are used as physical addresses. The MMU instruction, PFLUSH, can be executed successfully despite the state of the E-bit. If translation is disabled and an access does not match a transparent translation register (TTR), the default attributes for the access on the TTR is defined by the DCO, DUO, DCI, DWO, DUI (default TTR) bits in TCR.

P—Page Size

This bit selects the memory page size.

- 0 = 4 Kbytes
- 1 = 8 Kbytes

NAD—No Allocate Mode (Data ATC)

This bit freezes the data ATC in the current state, by enforcing a no-allocate policy for all accesses. Accesses can still hit, misses will cause a table search. A write access which finds a corresponding valid read will update the M-bit and the entry remains valid.

- 0 = Disabled
- 1 = Enable

NAI—No Allocate Mode (Instruction ATC)

This bit freezes the instruction ATC in the current state, by enforcing a no-allocate policy for all accesses. Accesses can still hit, misses will cause a table search.

- 0 = Disabled
- 1 = Enable

FOTC—1/2-Cache Mode (Data ATC)

- 0 = The data ATC operates with 64 entries.
- 1 = The data ATC operates with 32 entries.

FITC—1/2-Cache Mode (Instruction ATC)

- 0 = The instruction ATC operates with 64 entries.
- 1 = The instruction ATC operates with 32 entries.

DCO—Default Cache Mode (Data Cache)

- 00 = Writethrough, cachable
- 01 = Copyback, cachable
- 10 = Cache-inhibited, precise exception model
- 11 = Cache-inhibited, imprecise exception model

DUO—Default UPA bits (Data Cache)

These bits are two user-defined bits for operand accesses (see **4.2.2.3 Descriptor Field Definitions**).

DWO—Default Write Protect (Data Cache)

- 0 = Reads and writes are allowed.
- 1 = Reads are allowed, writes cause a protection exception.

DCI—Default Cache Mode (Instruction Cache)

- 00 = Writethrough, cachable
- 01 = Copyback, cachable
- 10 = Cache-inhibited, precise exception model
- 11 = Cache-inhibited, imprecise exception model

DUI—Default UPA Bits (Instruction Cache)

These bits are two user-defined bits for instruction prefetch bus cycles (see **4.2.2.3 Descriptor Field Definitions**)

Bit 0—Reserved by Motorola. Always read as zero.

Memory Management Unit

4.1.3 Transparent Translation Registers

The data transparent translation registers (DTTR0 and DTTR1) and instruction transparent translation registers (ITTR0 and ITTR1) are 32-bit registers that define blocks of logical address space that are untranslated by the MMU (the logical address is the physical address). The TTRs operate independently of the E-bit in the TCR and the state of the MDIS signal. Data transfers to and from these registers are long-word transfers. The TTR fields are defined following Figure 4-5, which illustrates TTR format. Bits 12–10, 7, 4, 3, 1, and 0 always read as zero.

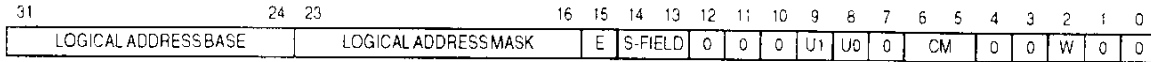

Figure 4-5. Transparent Translation Register Format

Bits 31–24—Logical Address Base

This 8-bit field is compared with address bits A31–A24. Addresses that match in this comparison (and are otherwise eligible) are transparently translated.

Bits 23–16—Logical Address Mask

Since this 8-bit field contains a mask for the Logical Address Mask field, setting a bit in this field causes the corresponding bit in the Logical Address Base field to be ignored. Blocks of memory larger than 16 Mbytes can be transparently translated by setting some of the logical address mask bits to ones. The low-order bits of this field can be set to define contiguous blocks larger than 16 Mbytes. The mask can be used to define multiple non-contiguous blocks of addresses.

E—Enable

This bit enables or disables transparent translation of the block defined by this register:

- 0 = Transparent translation disabled
- 1 = Transparent translation enabled

S—Supervisor Mode

This field specifies the way FC2 is used in matching an address:

- 00 = Match only if FC2 = 0 (user mode access)
- 01 = Match only if FC2 = 1 (supervisor mode access)
- 1X = Ignore FC2 when matching

U0, U1—User Page Attributes

The user defines these bits, and the MC68060 does not interpret them. U0 and U1 are echoed to the UPA0 and UPA1 signals, respectively, if an external bus transfer results

from an access. These bits can be programmed by the user to support external addressing, bus snooping, or other applications.

CM—Cache Mode

This field selects the cache mode and access precision as follows:

- 00 = Cachable, Writethrough
- 01 = Cachable, Copyback
- 10 = Cache-Inhibited, Precise Exception Model
- 11 = Cache-Inhibited, Imprecise Exception Model

Section 5 Caches provides detailed information on caching modes.

W—Write Protect

This bit indicates the write privilege of the TTR block.

- 0 = Read and write accesses permitted
- 1 = Write accesses not permitted

Bits 4,3,1,0—Reserved by Motorola.

4.2 LOGICAL ADDRESS TRANSLATION

The primary function of the MMUs is to translate logical addresses to physical addresses. The MMUs perform translations according to control information in translation tables. The operating system creates these translation tables and stores them in memory. The processor then searches through a translation table as needed and stores the resulting translation in an ATC.

4.2.1 Translation Tables

Both instruction and data access use the same translation tree. Separate translations trees are available for user and supervisor accesses.

Figure 4-6 illustrates the three-level tree structure of a general translation table supported by the MC68060. The root- and pointer-level tables contain the base addresses of the tables at the next level. The page-level tables contain either the physical address for the translation or a pointer to the memory location containing the physical address. Only a portion of the translation table for the entire logical address space is required to be resident in memory at any time—specifically, only the portion of the table that translates the logical addresses of the currently executing process. Portions of translation tables can be dynamically allocated as the process requires additional memory.

The current privilege mode determines the use of the URP or SRP for translation of the access. The root pointer contains the base address of the translation table's root-level table. The translation table consists of several linked tables of descriptors. The table descriptors of the root- and pointer-levels can have resident or invalid descriptor types. The page descriptors of the page-level table have resident, indirect, or invalid descriptor types. The page descriptors of the page-level table can be resident, indirect, or invalid. A page descriptor defines the physical address of a page frame in memory that corresponds to the logical address of a page. An indirect descriptor, which contains a pointer to the actual page

Memory Management Unit

4

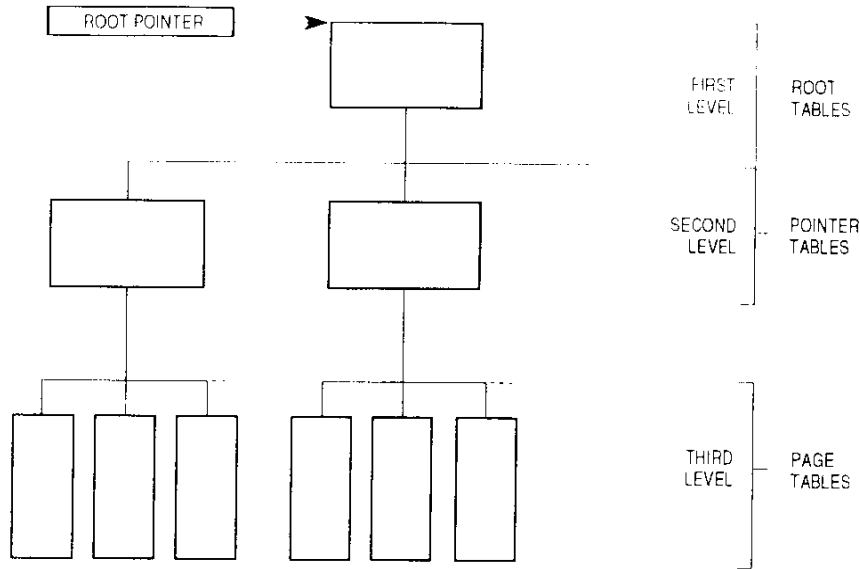

Figure 4-6. Translation Table Structure

descriptor, can be used when two or more logical addresses access a single page descriptor.

The table search uses logical addresses to access the translation tables. Figure 4-7 illustrates a logical address format, which is segmented into four fields: root index (RI), pointer index (PI), page index (PGI), and page offset. The first three fields extracted from the logical address index the base address for each table level. The seven bits of the logical address RI field are multiplied by 4 or shifted to the left by two bits. This sum is concatenated with the upper 23 bits of the appropriate root pointer (URP or SRP) to yield the physical address of a root-level table descriptor. Each of the 128 root-level table descriptors corresponds to a 32-Mbyte block of memory and points to the base of a pointer-level table.

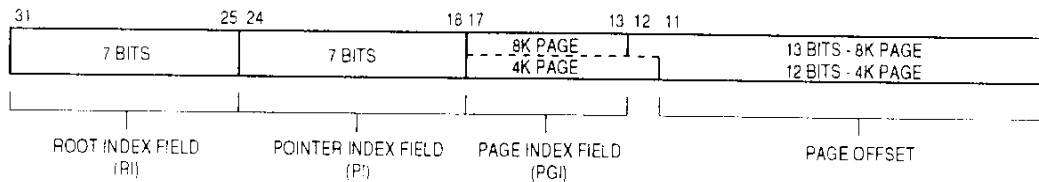

Figure 4-7. Logical Address Format

The seven bits of a logical address PI field are multiplied by 4 (shifted to the left by two bits) and concatenated with the fetched root-level descriptor's upper 23 bits to produce the physical address of the pointer-level table descriptor. Each of the 128 pointer-level table descriptors corresponds to a 256-Kbyte block of memory.

For 8-Kbyte pages, the five bits of the PGI field are multiplied by 4 (shifted to the left by two bits) and concatenated with the fetched pointer-level descriptor's upper 25 bits to produce the physical address of the 8-Kbyte page descriptor. The upper 19 bits of the page descriptor are the page frame's physical address. There are 32 8-Kbyte page descriptors in a page-level table.

Similarly, for 4-Kbyte pages, the six bits of the PGI field are multiplied by 4 (shifted to the left by two bits) and concatenated with the fetched pointer-level descriptor's upper 24 bits to produce the physical address of the 4-Kbyte page descriptor. The upper 20 bits of the page descriptor are the page frame's physical address. There are 64 4-Kbyte page descriptors in a page-level table.

Write-protect status is accumulated from each level's descriptor and combined with the status from the page descriptor to form the ATC entry status. The MC68060 creates the ATC entry from the page frame address and the associated status bits and uses this address and attributes to generate a bus access. Refer to **4.3 Address Translation Caches** for details on ATC entries.

If the descriptor from a page table is an indirect descriptor, the page descriptor pointed to by this descriptor is fetched. Invalid descriptors can be used at any level of the tree except the root. When a table search for a normal translation encounters an invalid descriptor, the processor takes an access error exception. The invalid descriptor can be used to identify either a page or branch of the tree that has been stored on an external device and is not resident in memory or a portion of the translation table that has not yet been defined. In these two cases, the exception routine can either restore the page from disk or add to the translation table. Figure 4-8 and Figure 4-9 illustrate detailed flowcharts of table search and descriptor fetch operations.

A table search terminates successfully when a page descriptor is encountered. The occurrence of an invalid descriptor or a transfer error acknowledge also terminates a table search, and the MC68060 takes an access error exception immediately on the data access and is delayed for instruction fetches until the instruction is ready to be executed. The exception handler should distinguish between anticipated conditions and true error conditions. The exception handler can correct an invalid descriptor that indicates a nonresident page or one that identifies a portion of the translation table yet to be allocated. An access error due to a system malfunction can require the exception handler to write an error message and terminate the task. The fault status long word (FSLW) of the access error stack frame provides detailed information regarding the cause of the exception. Refer to **Section 8 Exception Processing** for more information on exception handling.

The processor does not use the data cache when performing a table search. Therefore, translation tables must not be placed in copyback space, since the normal accesses which build the translation tables would be cached and not written to external memory, but the processor only uses tables in external memory. This is a functional difference between the MC68060 and the MC68040.

Table and page descriptors must not be left in a state that is incoherent to the processor. Violation of this restriction can result in an undefined operation. Page descriptors must not

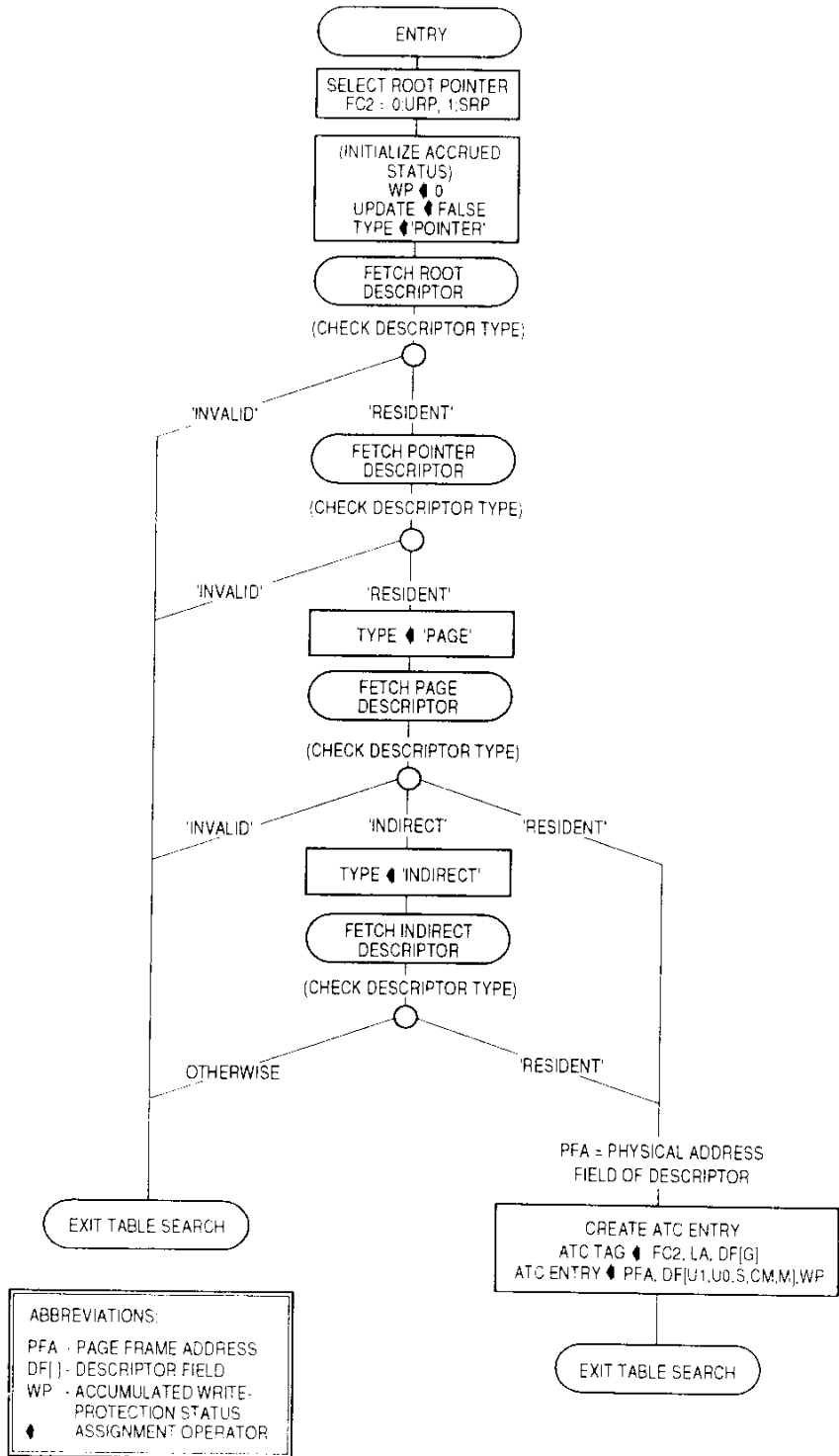

Figure 4-8. Detailed Flowchart of Table Search Operation

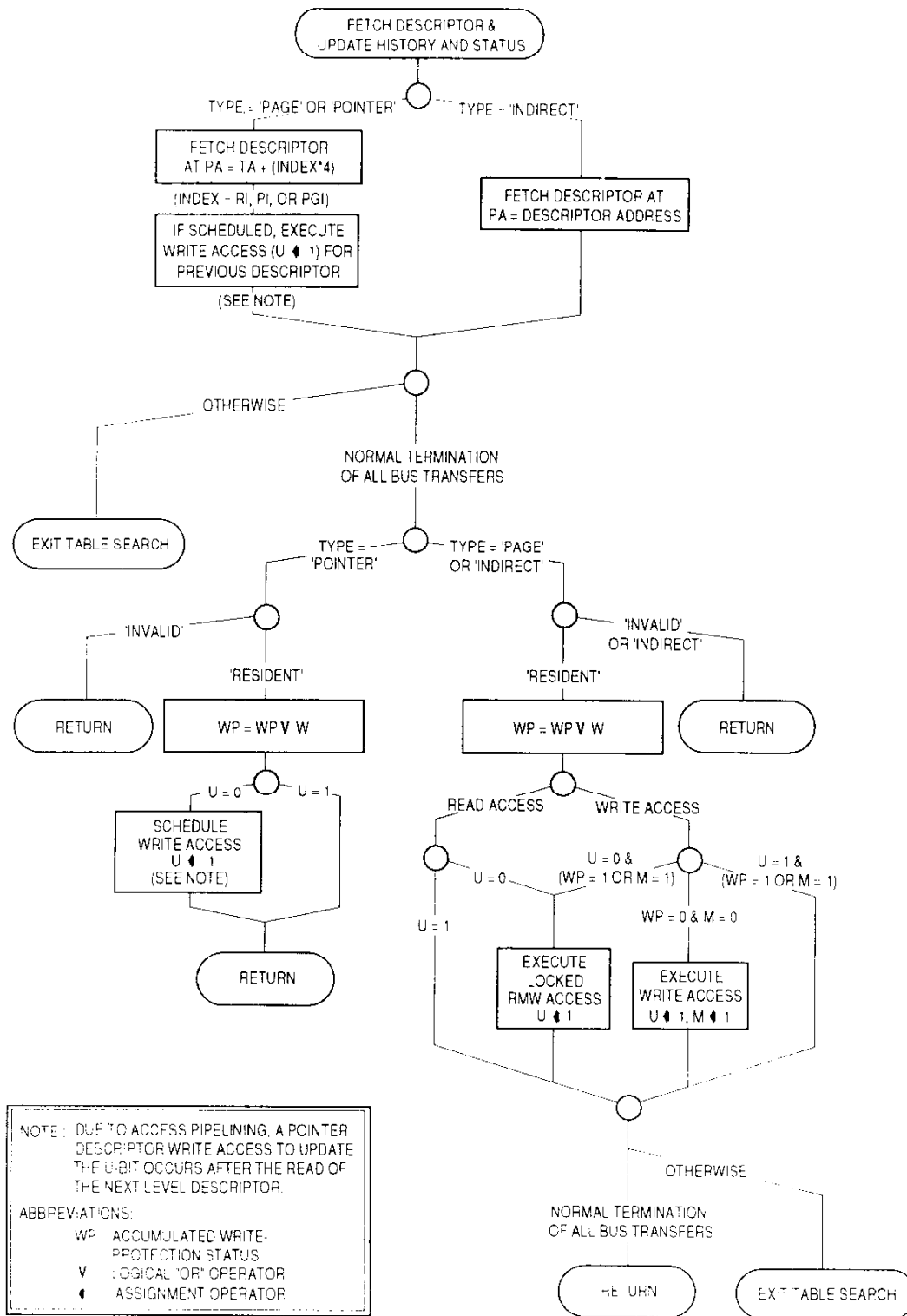

Figure 4-9. Detailed Flowchart of Descriptor Fetch Operation

Memory Management Unit

have an encoding of U-bit = 0, M-bit = 1, and PDT field = 01 or 11. This encoding indicates that the page descriptor is resident, not used, and modified. The processor's table search algorithm never leaves a descriptor in this state. This state is possible through direct manipulation by the operating system for this specific instance.

4.2.2 Descriptors

4

There are three types of descriptors used in the translation tables, root, pointer, and page. Root table descriptors are used in root-level tables and pointer table descriptors are used in pointer-level tables. Descriptors in the page-level tables contain either a page descriptor for the translation or an indirect descriptor that points to a memory location containing the page descriptor. The P-bit in the TCR selects the page size as either 4 or 8 Kbytes.

4.2.2.1 TABLE DESCRIPTORS. Figure 4-10 illustrates the formats of the root and pointer table descriptors.

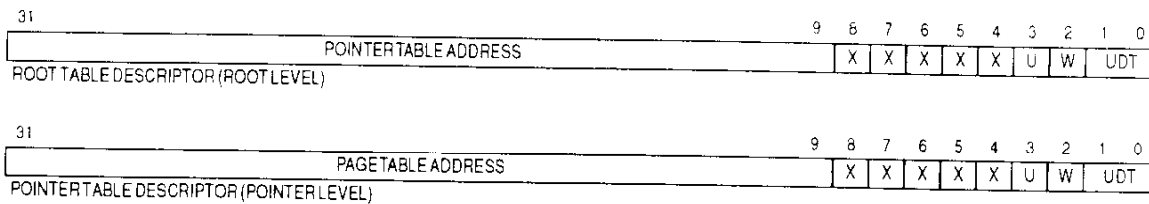

Figure 4-10. Table Descriptor Formats

4.2.2.2 PAGE DESCRIPTORS. Figure 4-11 illustrates the page descriptors for both 4-Kbyte and 8-Kbyte page sizes. Refer to **Section 5 Caches** for details concerning caching page descriptors.

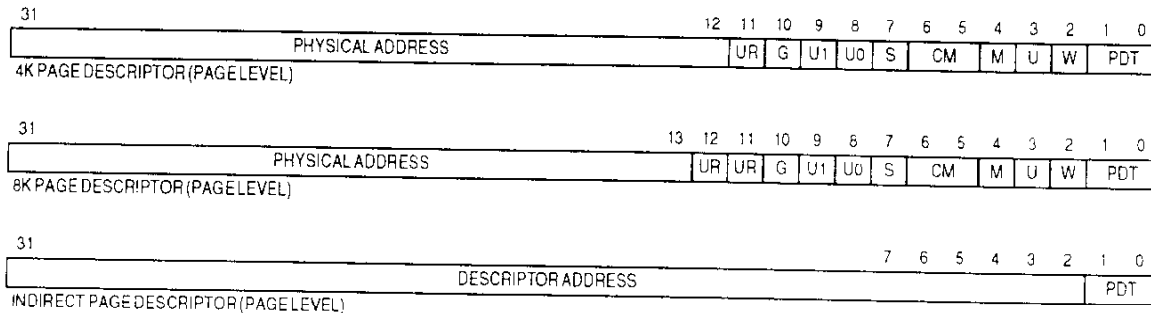

Figure 4-11. Page Descriptor Formats

4.2.2.3 DESCRIPTOR FIELD DEFINITIONS. The field definitions for the table- and page-level descriptors are listed in alphabetical order:

CM—Cache Mode

This field selects the cache mode and accesses serialization as follows:

- 00 = Cachable, Writethrough
- 01 = Cachable, Copyback
- 10 = Cache-Inhibited, Precise exception model
- 11 = Cache-Inhibited, Imprecise exception model

Section 5 Caches provides detailed information on caching modes.

Descriptor Address

This 30-bit field, which contains the physical address of a page descriptor, is only used in indirect descriptors.

G—Global

When this bit is set, it indicates the entry is global which gives the user the option of grouping entries as global or nonglobal for use when PFLUSHing the ATC, and has no other meaning. PFLUSH instruction variants that specify nonglobal entries do not invalidate global entries, even when all other selection criteria are satisfied. If these PFLUSH variants are not used, then system software can use this bit.

M—Modified

This bit identifies a page which has been written to by the processor. The MC68060 sets the M-bit in the corresponding page descriptor before a write operation to a page for which the M-bit is clear, except for write-protect or supervisor violations in which case the M-bit is not set. The read portion of a locked read-modify-write access is considered a write for updating purposes. The MC68060 never clears this bit.

PDT—Page Descriptor Type

This field identifies the descriptor as an invalid descriptor, a page descriptor for a resident page, or an indirect pointer to another page descriptor.

00 = Invalid

This code indicates that the descriptor is invalid. An invalid descriptor can represent a nonresident page or a logical address range that is out of bounds. All other bits in the descriptor are ignored. When an invalid descriptor is encountered, an ATC entry is not created.

01 or 11 = Resident

These codes indicate that the page is resident.

10 = Indirect

This code indicates that the descriptor is an indirect descriptor. Bits 31–2 contain the physical address of the page descriptor. This encoding is invalid for a page descriptor pointed to by an indirect descriptor (that is, only one level of indirection is allowed).

Memory Management Unit

Physical Address—

This 20-bit field contains the physical base address of a page in memory. The logical address supplies the low-order bits of the address required to index into the page. When the page size is 8-Kbyte, the least significant bit of this field is not used.

S—Supervisor Protected

This bit identifies a page as supervisor only. Only programs operating in the supervisor mode are allowed to access the portion of the logical address space mapped by this descriptor when the S-bit is set. If the bit is clear, both supervisor and user accesses are allowed.

Page Table Address

This field contains the physical base address of a table of page descriptors. The low-order bits of the address required to index into the page table are supplied by the logical address.

U—Used

The processor automatically sets this bit when a descriptor is accessed in which the U-bit is clear. In a page descriptor table, this bit is set to indicate that the page corresponding to the descriptor has been accessed. In a pointer table, this bit is set to indicate that the pointer has been accessed by the MC68060 as part of a table search. The U-bit is updated before the MC68060 allows a page to be accessed. The processor never clears this bit.

U0, U1—User Page Attributes

These bits are user defined and the processor does not interpret them. U0 and U1 are echoed to the UPA0 and UPA1 signals, respectively, if an external bus transfer results from the access. Applications for these bits include extended addressing and snoop protocol selection.

UDT—Upper Level Descriptor Type

These bits indicate whether the next level table descriptor is resident.

00 or 01 = Invalid

These codes indicate that the table at the next level is not resident or that the logical address is out of bounds. All other bits in the descriptor are ignored. When an invalid descriptor is encountered, an ATC entry is not created.

10 or 11 = Resident

These codes indicate that the page is resident.

UR—User Reserved

These single bit fields are reserved for use by the user.

W—Write Protected

Setting the W-bit in a table descriptor write protects all pages accessed with that descriptor. When the W-bit is set, a write access or a locked read-modify-write access to the logical address corresponding to this entry causes an access error exception to be taken.

X—Motorola Reserved

These bit fields are reserved for future use by Motorola.

4.2.3 Translation Table Example

Figure 4-12 illustrates an access example to the logical address \$76543210 while in the supervisor mode with an 8-Kbyte memory page size. The RI field of the logical address, \$3B, is mapped into bits 8–2 of the SRP value to select a 32-bit root table descriptor at a root-level table. The selected root table descriptor points to the base of a pointer-level table, and the PI field of the logical address, \$15, is mapped into bits 8–2 of this base address to select a pointer descriptor within the table. This pointer table descriptor points to the base of a page-level table, and the PGI field of the logical address, \$1, is mapped into bits 6–2 of this base address to select a page descriptor within the table.

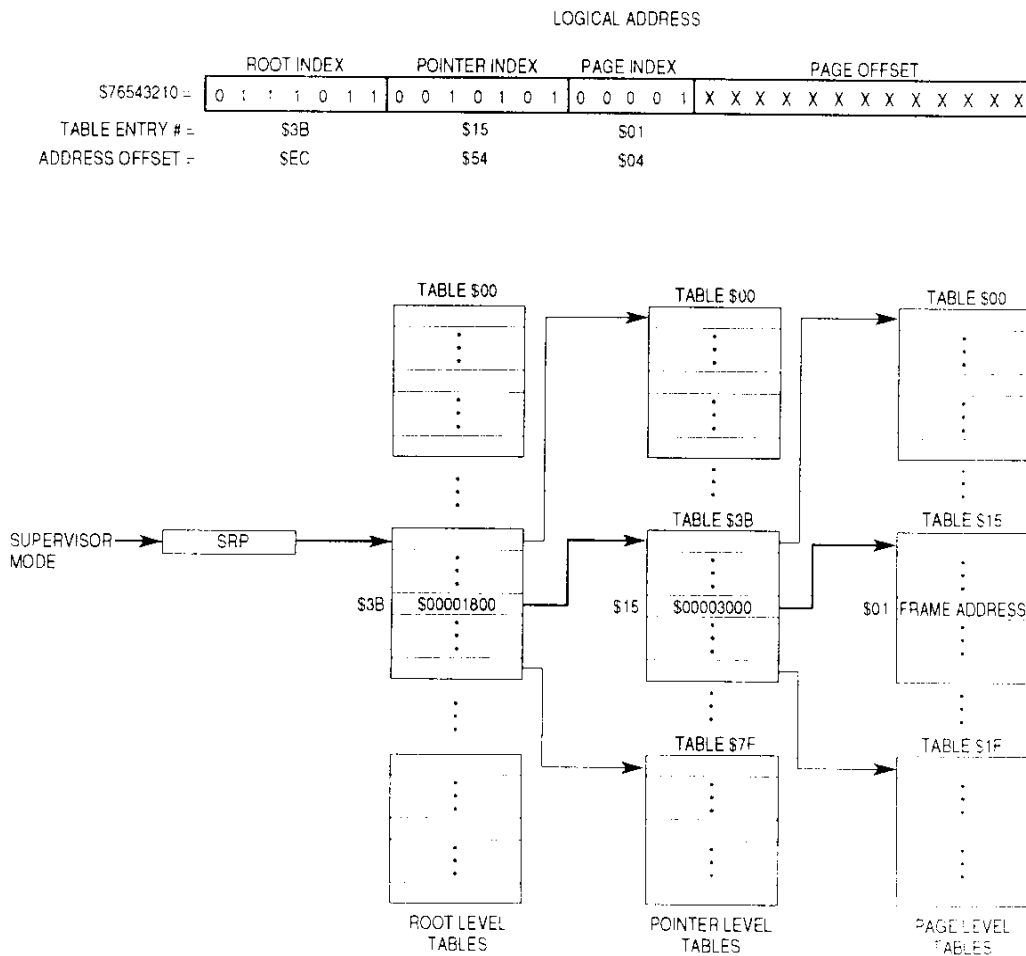

Figure 4-12. Example Translation Table

Memory Management Unit

4.2.4 Variations in Translation Table Structure

Several aspects of the MMU translation table structure are software configurable, allowing the system designer flexibility to optimize the performance of the MMUs for a particular system. The following paragraphs discuss the variations of the translation table structure.

4.2.4.1 INDIRECT ACTION. The MC68060 provides the ability to replace an entry in a page table with a pointer to an alternate entry. The indirection capability allows multiple tasks to share a physical page while maintaining only a single set of history information for the page (i.e., the modified indication is maintained only in the single descriptor). The indirection capability also allows the page frame to appear at arbitrarily different addresses in the logical address spaces of each task.

Using the indirection capability, single entries or entire tables can be shared between multiple tasks. Figure 4-13 illustrates two tasks sharing a page using indirect descriptors.

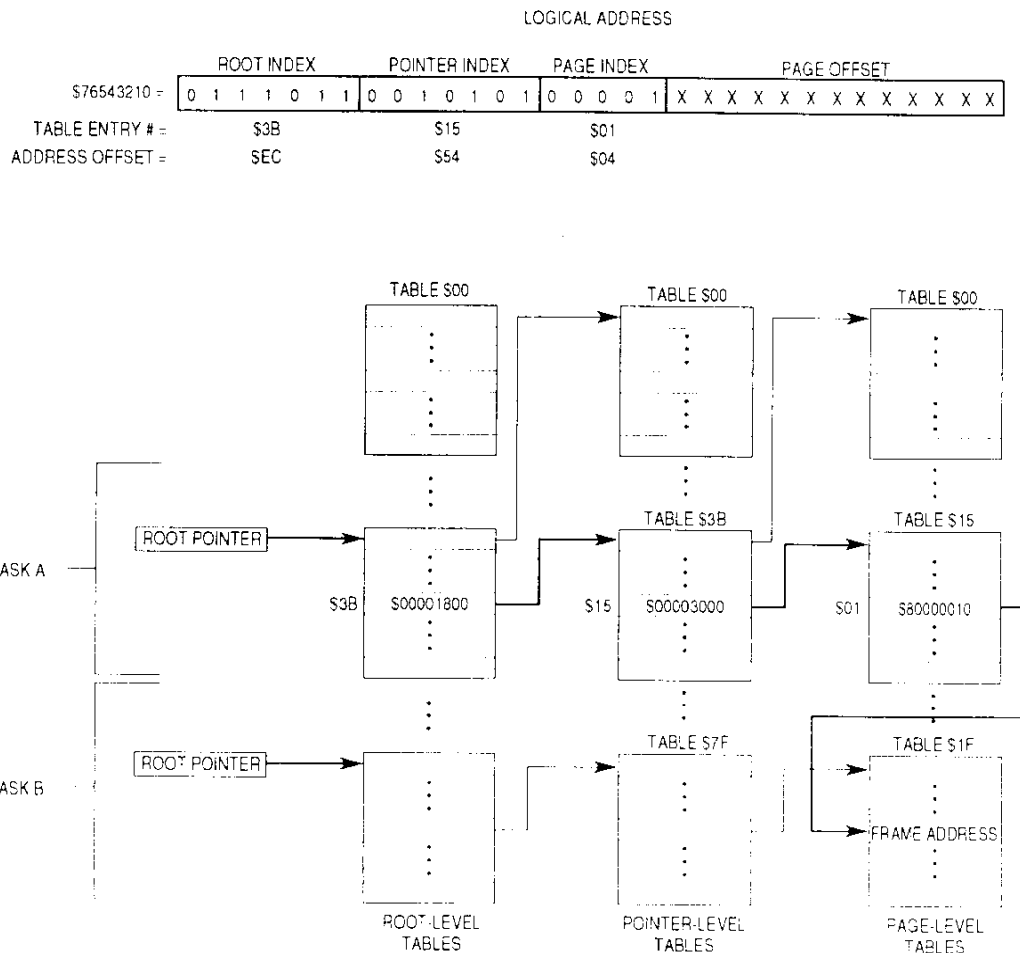

Figure 4-13. Translation Table Using Indirect Descriptors



When the MC68060 has completed a normal table search, it examines the PDT field of the last entry fetched from the page tables. If the PDT field contains an indirect (\$2) encoding, it indicates that the address contained in the highest order 30 bits of the descriptor is a pointer to the page descriptor that is to be used to map the logical address. The processor then fetches the page descriptor from this address and uses the physical address field of the page descriptor as the physical mapping for the logical address.

The page descriptor located at the address given by the indirect descriptor must not have a PDT field with an indirect encoding (it must be either a resident descriptor or invalid). Otherwise, the descriptor is treated as invalid, and the MC68060 takes an access error exception.

4

4.2.4.2 TABLE SHARING BETWEEN TASKS. More than one task can share a pointer- or page-level table by placing a pointer to a shared table in the address translation tables. The upper (nonshared) tables can contain different write-protected settings, allowing different tasks to use the memory areas with different write permissions. In Figure 4-14, two tasks share the memory translated by the table at the pointer table level. Task A cannot write to the shared area; task B, however, has the W-bit clear in its pointer to the shared table so that it can read and write the shared area. Also, the shared area appears at different logical addresses for each task. Figure 4-14 illustrates shared tables in a translation table structure.

4.2.4.3 TABLE PAGING. The entire translation table for an active task need not be resident in main memory. In the same way that only the working set of pages must be allocated in main memory, only the tables that describe the resident set of pages need be available. Placing the invalid code (\$0 or \$1) in the UDT field of the table descriptor that points to the absent table(s) implements this paging of tables. When a task attempts to use an address that an absent table would translate, the MC68060 is unable to locate a translation and takes an access error exception when the access is needed (immediately for operand accesses and when the instruction is needed for instructions).

The operating system determines that the invalid code in the descriptor corresponds to non-resident tables. This determination can be facilitated by using the unused bits in the descriptor to store status information concerning the invalid encoding. The MC68060 does not interpret or modify an invalid descriptor's fields except for the UDT field. This interpretation allows the operating system to store system-defined information in the remaining bits. Information typically stored includes the reason for the invalid encoding (tables paged out, region unallocated, etc.) and possibly the disk address for nonresident tables. Figure 4-15 illustrates an address translation table in which only a single page table (table \$15) is resident; all other page tables are not resident.

4.2.4.4 DYNAMICALLY ALLOCATED TABLES. Similar to paged tables, a complete translation table need not exist for an active task. The operating system can dynamically allocate the translation table based on requests for access to particular areas.

Since it is difficult and less efficient to predict and reserve memory in advance for a task, an operating system may choose to allocate no memory for a task until a demand is made requesting access. This access may be to a previously unused area or for data that is no longer resident in memory. If the access error handler adds to and updates the translation

Memory Management Unit

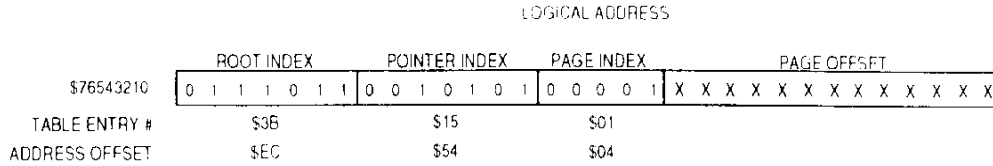

4

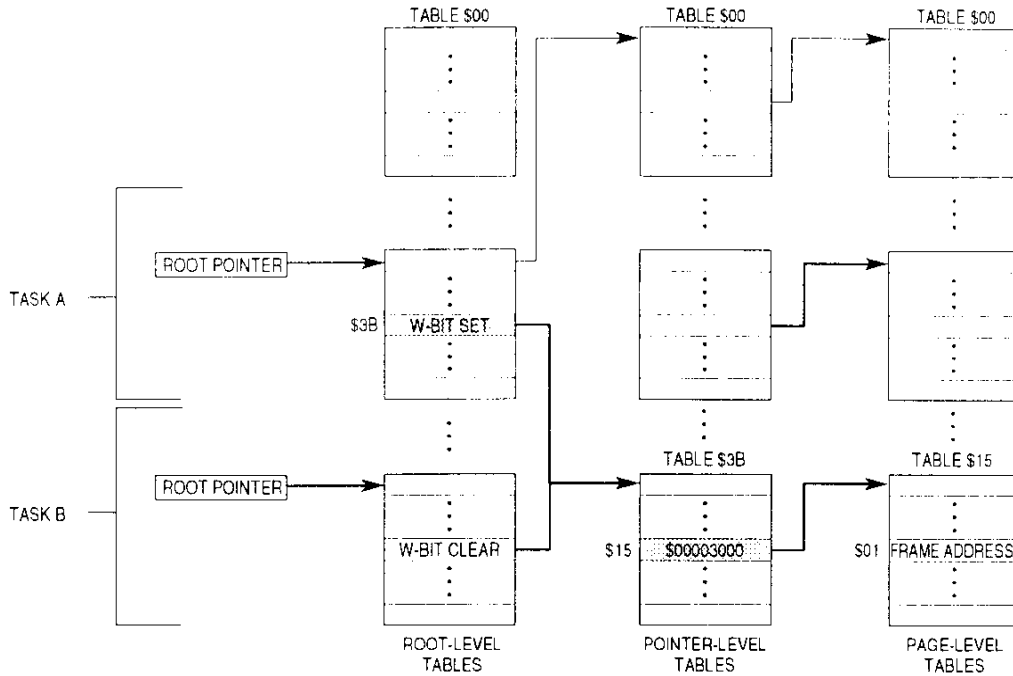

* PAGE FRAME ADDRESS SHARED BY TASK A AND B; WRITE PROTECTED FROM TASK A.

Figure 4-14. Translation Table Using Shared Tables

table for each demand, then the process of making such demands builds the translation table.

For example, consider an operating system that is preparing the system to execute a previously unexecuted task that has no translation table. Rather than guessing what the memory-usage requirements of the task are, the operating system creates a translation table for the task that maps one page corresponding to the initial value of the program counter (PC) for that task and one page corresponding to the initial stack pointer of the task, leaving the other branches with invalid descriptors. All other branches of the translation table for this task remain unallocated until the task requests access to the areas mapped by these branches. This technique allows the operating system to construct a minimal translation table for each task, conserving physical memory utilization and minimizing operating system overhead.

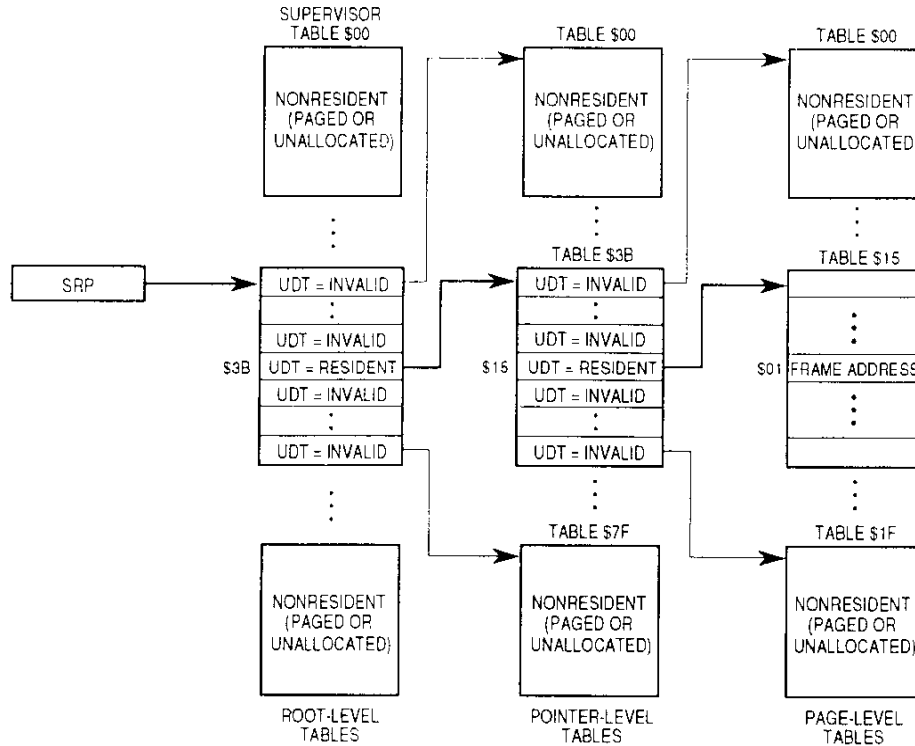
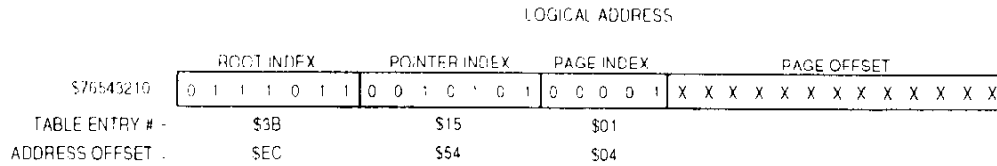

Figure 4-15. Translation Table with Nonresident Tables

4.2.5 Table Search Accesses

Table search accesses bypass the data cache. No allocation is done and no cache search is performed. Translation tables must not be placed in copyback space, since the normal accesses which build the translation tables would be cached and not written to external memory, but the processor only uses tables in external memory.

During a table search, the U- and M-bits of the table descriptors are examined. For any access, if the U-bit is not set, the processor sets it using a complete read-modify-write sequence with the LOCK pin asserted. LOCK is asserted in this case to avoid loss of the status in certain multiprocessor applications which share translation tables. For a write access, if the M-bit in the page descriptor is not set, and if the page is not write-protected (W = 0) and the access is not a supervisor violation (for user accesses, the S-bit of the page descriptor must be clear), then the M-bit is set using a simple write. The U- and M-bits are

Memory Management Unit

updated before the MC68060 allows a page to be accessed. Table 4-1 lists the page descriptor update operations for each combination of U-bit, M-bit, write-protected, and read or write access type.

Table 4-1. Updating U-Bit and M-Bit for Page Descriptors

Previous Status		WP Bit	Access Type	Page Descriptor Update Operation	New Status	
U-Bit	M-Bit				U-Bit	M-Bit
0	0	X	Read	Locked RMW Access to Set U	1	0
0	1			Locked RMW Access to Set U	1	1
1	0			None	1	0
1	1			None	1	1
0	0	0	Write	Write to Set U and M	1	1
0	1			Write to Set U	1	1
1	0			Write to Set M	1	1
1	1			None	1	1
0	0	1	Write	None	0	0
0	1			None	0	1
1	0			None	1	0
1	1			None	1	1

NOTE: WP indicates the accumulated write-protect status.

An alternate address space access is a special case that is immediately used as a physical address without translation. Because the MC68060 implements a merged instruction and data space, instruction address spaces (SFC/DFC = \$6 or \$2) using the MOVES instruction are converted into data references (SFC/DFC = \$5 or \$1). The data memory unit handles these translated accesses as normal data accesses. If the access fails due to an ATC fault or a physical bus error, the resulting access error stack frame contains the converted function code in the TM field for the faulted access. If the MOVES instruction is used to write instruction address space, then to maintain cache coherency, the corresponding addresses must be invalidated in the instruction cache. The SFC and DFC values and results for normal (TT = 0) and for MOVES (TT = 10) accesses are listed in Table 4-2.

Table 4-2. SFC and DFC Values

SFC/DFC Value	Results	
	TT	TM
000	10	000
001	00	001
010	00	001
011	10	011
100	10	100
101	00	101
110	00	101
111	10	111

4.2.6 Address Translation Protection

The MC68060 MMUs provide separate translation tables for supervisor and user address spaces. The translation tables contain both mapping and protection information. Each table and page descriptor includes a write-protect (W) bit that can be set to provide write protec-



tion at any level. Page descriptors also contain a supervisor-only (S) bit that can limit access to programs operating at the supervisor privilege level.

The protection mechanisms can be used individually or in any combination to protect:

- Supervisor address space from accesses by user programs.
- User address space from accesses by other user programs.
- Supervisor and user program spaces from write accesses (implicitly supported by designating all memory pages used for program storage as write protected).
- One or more pages of memory from write accesses.



4.2.6.1 SUPERVISOR AND USER TRANSLATION TABLES. One way of protecting supervisor and user address spaces from unauthorized accesses is to use separate supervisor and user translation tables. Separate trees protect supervisor programs and data from accesses by user programs and user programs and data from access by supervisor programs. Supervisor programs may access user space through the MOVES instruction. With a user-space SFC/DFC, the MOVES access will be translated according to the user-mode translation tables. This translation table can be common to all tasks. Figure 4-16 illustrates separate translation tables for supervisor accesses and for two user tasks that share the common supervisor space. Each user task has a translation table with unique mappings for the logical addresses in its user address space.

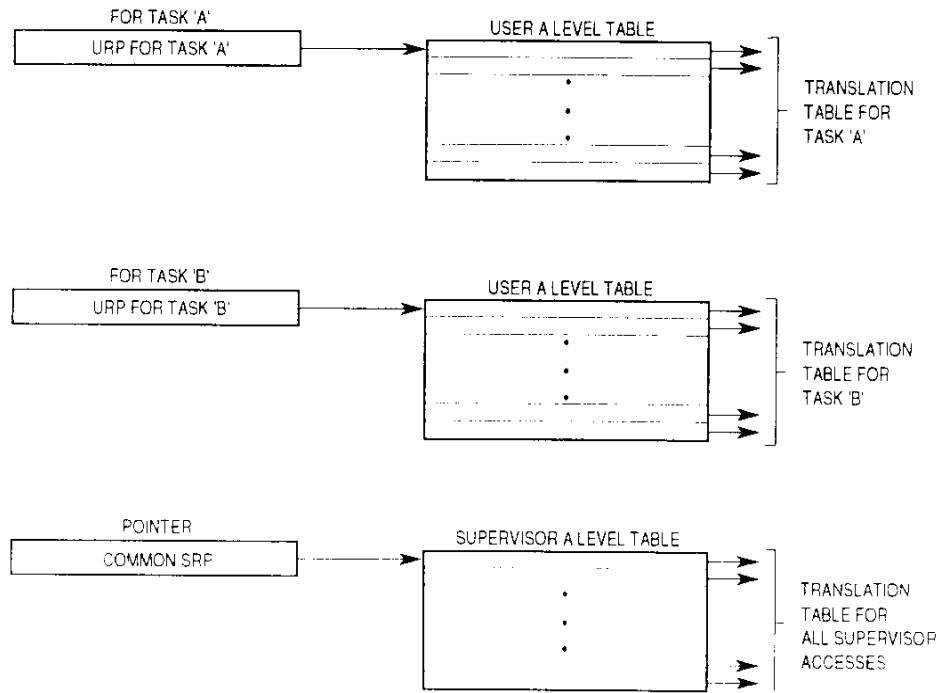

Figure 4-16. Translation Table Structure for Two Tasks

Memory Management Unit

4

4.2.6.2 SUPERVISOR ONLY. A second mechanism protects supervisor programs and data without requiring segmenting of the logical address space into supervisor and user address spaces. Page descriptors contain S-bits to protect areas of memory from access by user programs. When a table search for a user access encounters an S-bit set in a page descriptor, the table search ends, and an access error exception is taken immediately for data accesses, or when the instruction is needed for instruction accesses. The S-bit can be used to protect one or more pages from user program access. Supervisor and user mode accesses can share descriptors by using indirect descriptors or by sharing tables. The entire user and supervisor address spaces can be mapped together by loading the same root pointer address into both the SRP and URP registers.

4.2.6.3 WRITE PROTECT. The MC68060 provides write protection independent of other protection mechanisms. All table and page descriptors contain W-bits to protect areas of memory from write accesses of any kind, including supervisor writes. On a read-only access, if the ATC misses, and a W-bit (write-protect) is set in one or more of the table descriptors, the table search completes normally and the ATC is loaded with the internal W-bit set. Subsequent read-only accesses are allowed, but a subsequent write or read-modify-write access to that address will immediately take the access error exception as a write-protect violation. The ATC entry and the related translation table entries are unchanged. On a write or read-modify-write access, if the ATC misses and a W-bit is found set in any table descriptor, the table search will terminate immediately and the access error exception is taken. In this case the ATC is not loaded, and the translation table history bits (U and M) for that descriptor are not updated. The W-bit can be used to protect the entire area of memory defined by a branch of the translation table or protect only one or more pages from write accesses. Figure 4-17 illustrates a memory map of the logical address space organized to use supervisor-only and write-protect bits for protection. Figure 4-18 illustrates an example translation table for this technique.

SUPERVISOR AND USER SPACE
THIS AREA IS SUPERVISOR ONLY, READ-ONLY
THIS AREA IS SUPERVISOR ONLY, READ/WRITE
THIS AREA IS SUPERVISOR OR USER, READ-ONLY
THIS AREA IS SUPERVISOR OR USER, READ/WRITE

Figure 4-17. Logical Address Map with Shared Supervisor and User Address Spaces

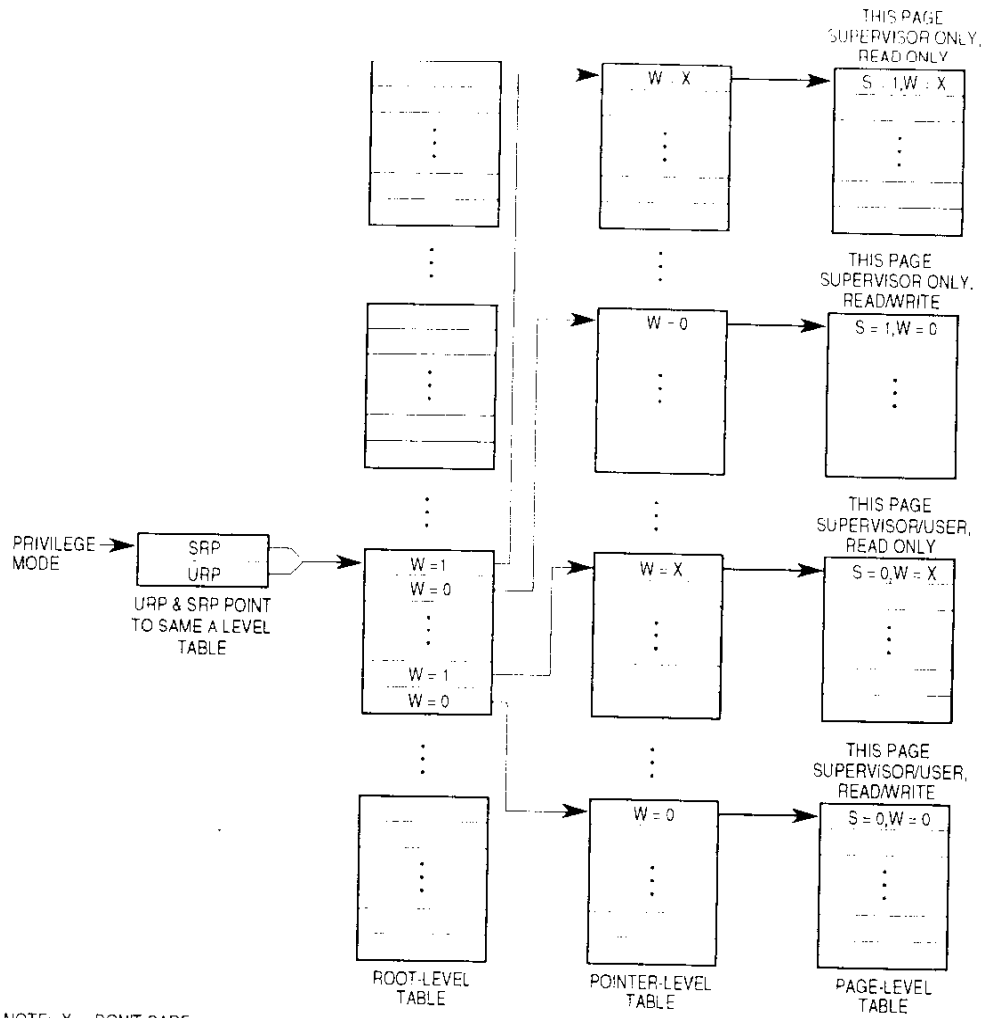

Figure 4-18. Translation Table Using S-Bit and W-Bit To Set Protection

4.3 ADDRESS TRANSLATION CACHES

The ATCs in the MMUs are four-way set-associative caches that each store 64 logical-to-physical address translations and associated page information similar in form to the corresponding page descriptors in memory. The purpose of the ATC is to provide a fast mechanism for address translation by avoiding the overhead associated with a table search of the logical-to-physical mapping of recently used logical addresses. Figure 4-19 illustrates the organization of the ATC.

4

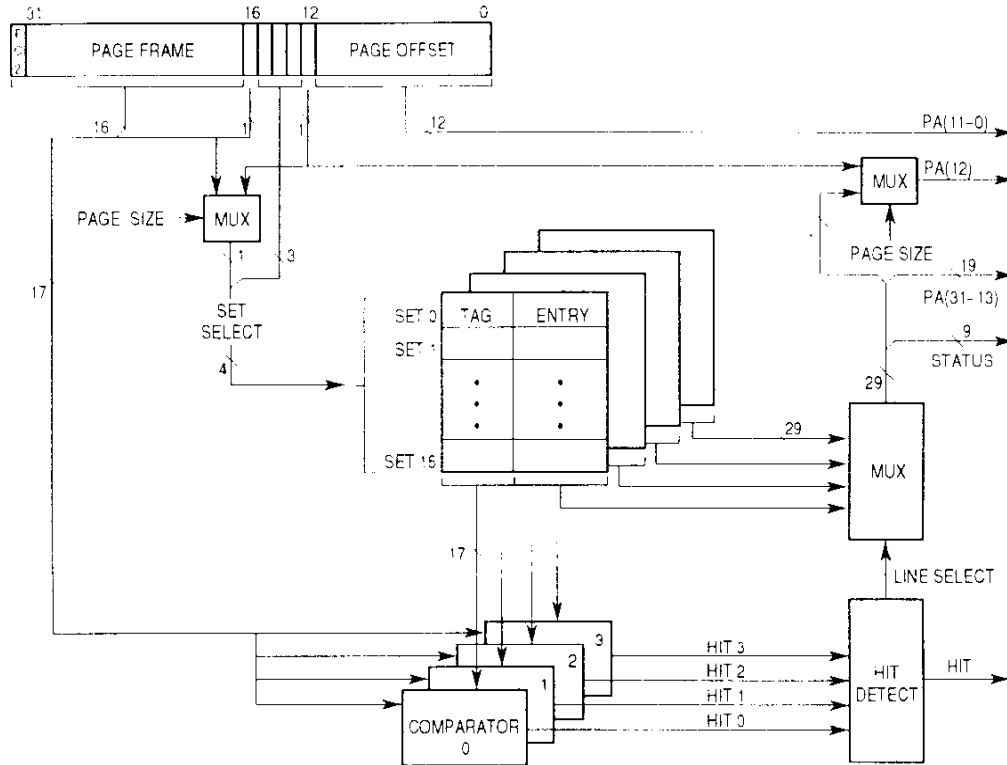
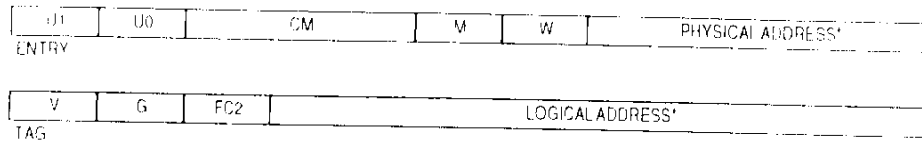

Figure 4-19. ATC Organization

Each ATC entry consists of a physical address, attribute information from a corresponding page descriptor, and a tag that contains a logical address and status information. Figure 4-20, which illustrates the entry and tag fields, is followed by field definitions listed in alphabetical order.



*FOR 4-KBYTE PAGE SIZES, THIS FIELD USES ADDRESS BITS 31-12; FOR 8-KBYTE PAGE SIZES, BITS 31-13

Figure 4-20. ATC Entry and Tag Fields



CM—Cache Mode

This field selects the cache mode and accesses serialization as follows:

- 00 = Cachable, Writethrough
- 01 = Cachable, Copyback
- 10 = Noncachable, Precise
- 11 = Noncachable, Imprecise

Section 5 Caches provides detailed information on caching modes.

FC2—Function Code Bit 2 (Supervisor/User)

This bit contains the function code corresponding to the logical address in this entry. FC2 is set for supervisor mode accesses and cleared for user mode accesses.

G—Global

When set, this bit indicates the entry is global. Global entries are not invalidated by the PFLUSH instruction variants that specify nonglobal entries, even when all other selection criteria are satisfied.

Logical Address

This 16-bit field contains the most significant logical address bits for this entry. All 16 bits of this field are used in the comparison of this entry to an incoming logical address when the page size is 4 Kbytes. For 8-Kbytes pages, the least significant bit of this field is ignored.

M—Modified

The modified bit is set when a valid write access to the logical address corresponding to the entry occurs. If the M-bit is clear and a write access to this logical address is attempted, the MC68060 suspends the access, initiates a table search to set the M-bit in the page descriptor, and writes over the old ATC entry with the current page descriptor information. The MMU then allows the original write access to be performed. This procedure ensures that the first write operation to a page sets the M-bit in both the ATC and the page descriptor in the translation tables, even when a previous read operation to the page had created an entry for that page in the ATC with the M-bit clear.

Physical Address

The upper bits of the translated physical address are contained in this field.

Memory Management Unit

U0, U1—User Page Attributes

These user-defined bits are not interpreted by the MC68060. U0 and U1 are echoed to the UPA0 and UPA1 signals, respectively, if an external bus transfer results from the access.

V—Valid

When set, this bit indicates that the entry is valid. This bit is set when the MC68060 loads an entry. A flush operation by a PFLUSH or PFLUSHA instruction that selects this entry clears the bit.

W—Write Protected

This write-protect bit is set when a W-bit is set in any of the descriptors encountered during the table search for this entry. Setting a W-bit in a table descriptor write protects all pages accessed with that descriptor. When the W-bit is set, a write access or a locked read-modify-write access to the logical address corresponding to this entry causes an access error exception to be taken immediately.

For each access to a memory unit, the MMU uses the four bits of the logical address located just above the page offset (LA16–LA13 for 8K pages, LA15–LA12 for 4K pages) to index into the ATC. The tags are compared with the remaining upper bits of the logical address and FC2. If one of the tags matches and is valid, then the multiplexer chooses the corresponding entry to produce the physical address and status information. The ATC outputs the corresponding physical address to the cache controller, which accesses the data within the cache and/or requests an external bus cycle. Each ATC entry contains a logical address, a physical address, and status bits.

When the ATC does not contain the translation for a logical address, a miss occurs. The MMU aborts the current access and searches the translation tables in memory for the correct translation. If the table search completes without any errors, the MMU stores the translation in the ATC and provides the physical address and attributes for the access. Otherwise, if any bus errors (TEA asserted) or invalid descriptors are encountered, the ATC is not modified and an access error exception is taken. The MC68040 differs from the MC68060 in that the MC68040 ATC contains an R-bit. An R-bit is not needed on the MC68060 because the ATC is not updated when an access error occurs and therefore all ATC entries represent usable translations.

There are some variations in the logical-to-physical mapping because of the two page sizes. If the page size is 4 Kbytes, then logical address bit 12 is used to access the ATC's memory, the tag comparators use bit 16, and physical address bit 12 is an ATC output. If the page size is 8 Kbytes, then logical address bit 16 is used to access the ATC's memory, and physical address bit 12 is driven by logical address bit 12. It is advisable that a translation always be disabled before changing size and that the ATCs are flushed before enabling translation again.

The MMU is organized such that other operations always completely overlap the translation time of the ATCs; thus, no performance penalty is associated with ATC searches. The address translation occurs in parallel with indexing into the on-chip instruction and data caches.

The MMU replaces an invalid entry when the ATC stores a new address translation. When all entries in an ATC set are valid, the ATC selects a valid entry to be replaced, using a pseudo round robin replacement algorithm. A 2-bit counter, which is incremented for each ATC access, points to the entry to replace when an access misses in the ATC. ATC hit rates are application and page-size dependent, but hit rates ranging from 98% to greater than 99% can be expected. These high rates are achieved because the ATCs are relatively large (64 entries) and utilization efficiency is high with 8-Kbyte and 4-Kbyte page sizes.

4.4 TRANSPARENT TRANSLATION

4

Four independent TTRs (DTT0 and DTT1 in the data MMU, ITT0 and ITT1 in the instruction MMU) define four blocks of logical address space to be translated to physical address space. These logical address spaces must be at least 16 Mbytes and can overlap or be separate. Each TTR can be disabled and completely ignored. The following description assumes that the TTRs are enabled.

When an MMU receives an address to be translated, the privilege mode and the eight high-order bits of the address are compared to the logical address spaces defined by the two TTRs for the corresponding MMU. The logical address space for each TTR is defined by an S-field, logical base address field, and logical address mask field. The S-field allows matching either user or supervisor accesses or both accesses. When a bit in the logical address mask field is set, the corresponding bit of the logical base address is ignored in the address comparison. Setting successively higher order bits in the address mask increases the size of the physical address space.

The address for the current bus cycle and a TTR address match when the privilege mode and logical base address bits are equal. Each TTR can specify write protection for the block. When write protection is enabled for a block, write or locked read-modify-write accesses to the block are aborted.

By appropriately configuring a TTR, flexible transparent mappings can be specified (refer to **4.1.3 Transparent Translation Registers** for field identification). For instance, to transparently translate the user address space, the S-field is set to \$0, and the logical address mask is set to \$FF in both an instruction and data TTR. To transparently translate supervisor accesses of addresses \$00000000–\$0FFFFFFF with write protection, the logical base address field is set to \$0x, the logical address mask is set to \$0F, the W-bit is set to one, and the S-field is set to \$1. It is not necessary for the mask field to specify a contiguous block of memory. The inclusion of independent TTRs in both the instruction and data MMUs provides an exception to the merged instruction and data address space, allowing different translations for instruction and operand accesses. Also, since the instruction memory unit is only used for instruction prefetches, different instruction and data TTRs can cause PC relative operand fetches to be translated differently from instruction prefetches.

If either of the TTRs matched during an access to a memory unit (either instruction or data), the access is transparently translated. If both registers match, the TT0 status bits are used for the access. Transparent translation can also be implemented by the translation tables of the translation tables if the physical addresses of pages are set equal to their logical addresses.

Memory Management Unit

If the paged MMU is disabled (the E-bit in the TCR register is clear) and the TTRs are disabled or do not match, then the status and protection attributes are defined by the default translation bits (DCO, DUO, DWO, DCI, and DUI) in the TCR.

4.5 ADDRESS TRANSLATION SUMMARY

If the paged MMU is enabled (the E-bit in the TCR is set), the instruction and data MMUs process translations by first comparing the logical address and privilege mode with the parameters of the TTRs if they are enabled. If there is a match, the MMU uses the logical address as a physical address for the access. If there is no match, the MMU compares the logical address and privilege mode with the tag portions of the entries in the ATC and uses the corresponding physical address for the access when a match occurs. When neither a TTR nor a valid ATC entry matches, the MMU initiates a table search operation to obtain the corresponding physical address from the translation table. When a table search is required, the processor suspends instruction execution activity and, at the end of a successful table search, stores the address mapping in the appropriate ATC and retries the access. The MMU creates a valid ATC entry for the logical address. If the table search encounters an invalid descriptor, or a write-protect for a write, or is a user access and encounters a supervisor-only flag, then the access error exception is taken whenever the access is needed (immediately for operands and deferred for instruction fetches).

If a write or locked read-modify-write access results in an ATC hit but the page is write protected, the access is aborted, and an access error exception is taken. If the page is not write protected and the modified bit of the ATC entry is clear, a table search proceeds to set the modified bit in both the page descriptor in memory and in the ATC; the access is retried. The ATC provides the address translation for the access if the modified bit of the ATC entry is set for a write or locked read-modify-write access to an unprotected page and if none of the TTRs (instruction or data, as appropriate) match.

Figure 4-21 illustrates a general flowchart for address translation. The top branch of the flowchart applies to transparent translation. The bottom three branches apply to ATC translation.

4.6 \overline{RSTI} AND \overline{MDIS} EFFECT ON THE MMU

The following paragraph describes how the MMU is affected by the \overline{RSTI} and \overline{MDIS} pins.

4.6.1 Effect of \overline{RSTI} on the MMUs

When the MC68060 is reset by the assertion of the reset input signal, the E-bits of the TCR and TTRs are cleared, disabling address translation. This reset causes logical addresses to be passed through as physical addresses, allowing an operating system to set up the translation tables and MMU registers as required. After the translation tables and registers are initialized, the E-bit of the TCR can be set, enabling paged address translation. While address translation is disabled, the default TTR is used. The default TTR attribute bits are cleared upon reset, so that immediately after assertion of \overline{RSTI} the attributes will specify write-through cachable mode, no write protection, user page attribute bits cleared, and 1/2-cache mode disabled.

A reset of the processor does not invalidate any entries in the ATCs page size. A PFLUSH instruction must be executed to flush all existing valid entries from the ATCs after a reset

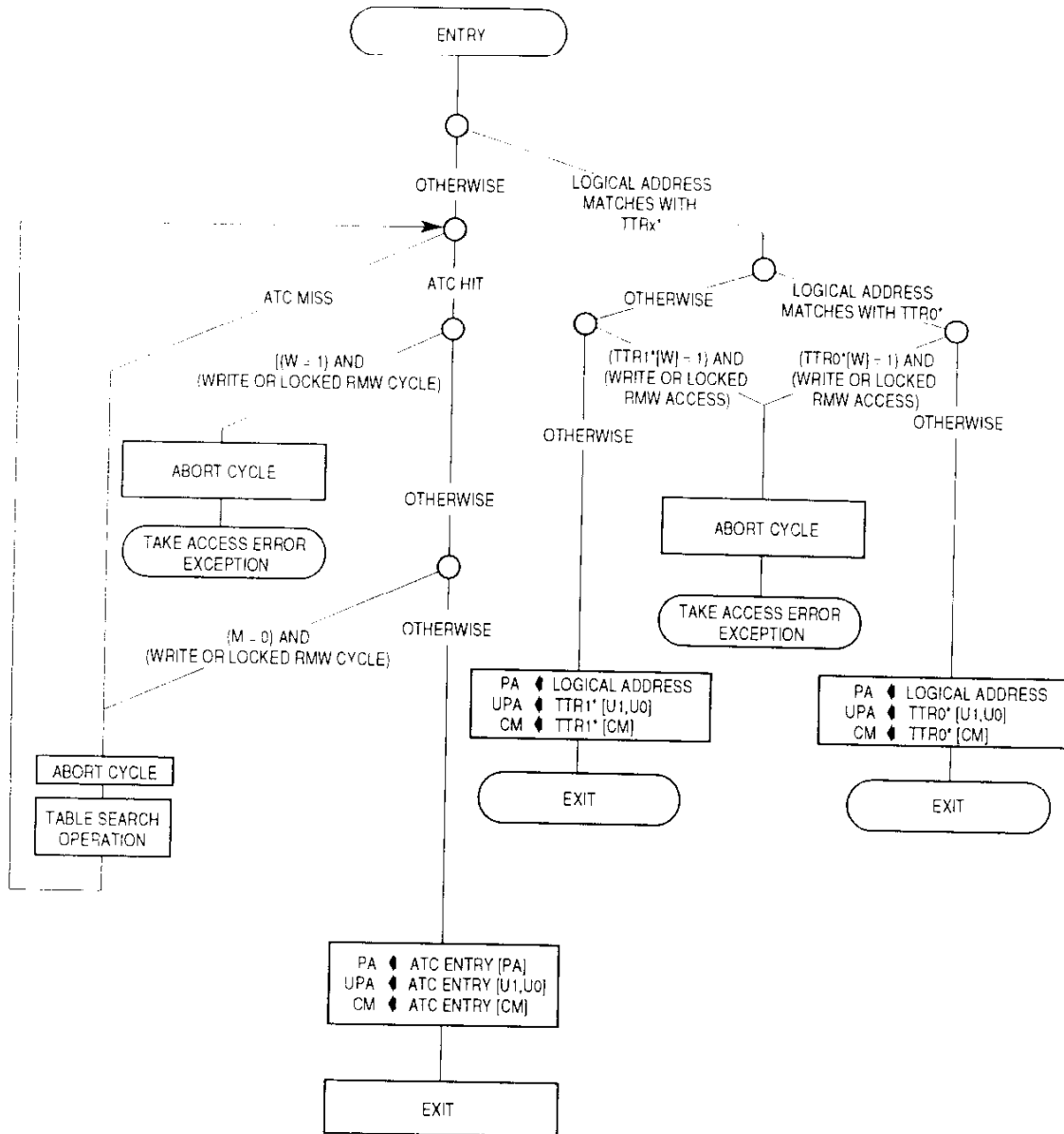

* Refers to either instruction or data transparent translation register.

Figure 4-21. Address Translation Flowchart

operation and before translation is enabled. PFLUSH can be executed even if the E-bit is cleared.

4.6.2 Effect of $\overline{\text{MDIS}}$ on Address Translation

The assertion of $\overline{\text{MDIS}}$ prevents the MMUs from performing ATC searches and the execution unit from performing table searches. With address translation disabled, logical addresses are used as physical addresses. $\overline{\text{MDIS}}$ disables the MMUs on the next internal access boundary when asserted and enables the MMUs on the next boundary after the signal is negated. The assertion of this signal does not affect the operation of the transparent translation registers or execution of the PFLUSH instruction.

4

4.7 MMU INSTRUCTIONS

The MC68060 instruction set includes three privileged instructions that perform MMU operations. The following paragraphs briefly describe each of these instructions. For detailed descriptions of these instructions, refer to M68000PR/AD, *M68000 Family Programmer's Reference Manual*.

4.7.1 MOVEC

The MOVEC instruction transfers data between an integer data register and any of the MC68060 control and status registers. The operating system uses the MOVEC instruction to control and monitor MMU operation by manipulating and reading the seven MMU registers.

4.7.2 PFLUSH

The PFLUSH instruction invalidates (flushes) address translation descriptors in the specified ATC(s). PFLUSHA, a version of the PFLUSH instruction, flushes all entries. The PFLUSH instruction flushes a user or supervisor entry with a specified logical address. The PFLUSHAN and PFLUSHN instruction variants qualify entry selection further by flushing only entries that are nonglobal, indicated by a cleared G-bit in the entry.

4.7.3 PLPA

The PLPA instruction ensures that an ATC is loaded with a valid translation, and returns the related physical address. If there is a hit in the ATC, and the access has write and supervisor privilege as specified, the PLPA returns the related physical address. If the PLPA misses in the ATC, a table search is performed. A successful table search results in the ATC being loaded with a valid translation; a table search which encounters an invalid descriptor, write-protection violation, bus error or a supervisor violation will cause the access error exception to be taken. There are two variants of PLPA, which are PLPAR and PLPAW, which check the privilege and set the table and ATC history bits as if a read or write access, respectively, were being performed.

SECTION 5 CACHES

The MC68060 contains two independent 8-Kbyte, on-chip caches which can be accessed simultaneously for instruction and operand data. The caches improve system performance by providing low latency data to the MC68060 instruction and data pipes. This decouples processor performance from system memory performance and increases bus availability for alternate bus masters.

5

As shown in Figure 5-1, the instruction and data caches are contained in the instruction and data memory units. The appropriate memory unit independently services instruction prefetch from the instruction fetch unit (IFU) and data requests from the operand pipe unit (OPU). The memory units translate the logical address in parallel with indexing into the cache. If the translated (physical) address matches one of the cache entries, the access hits in the cache. For a read operation, the memory unit supplies the data to the IPU instruction buffer or the OPU, and for a write operation, the memory unit updates the cache. If the access does not match one of the cache entries (misses in the cache) or a write access must be written through to memory, the appropriate memory unit sends an external bus request to the bus controller. The bus controller then reads or writes the required data. In the event that the bus controller receives an external bus request from both memory units, the bus controller invokes its priority scheme to choose between IPU and OPU requests.

To maintain cache coherency, the MC68060 provides automatic snoop-invalidation when it is not the bus master. Unlike the MC68040, the MC68060 cannot not source or sink cache data during alternate bus master accesses.

The MC68060 implements a bus snoop that maintains cache coherency by monitoring an alternate bus master access to memory and invalidating matching cache lines during the alternate bus master access. The MC68060 requires that memory pages shared with other bus masters be cache inhibited or marked cachable writethrough (instead of copyback). When a processor writes to writethrough pages, external memory is always updated through an external bus access after updating the cache, keeping memory and cached data consistent.

5.1 CACHE OPERATION

Both four-way set-associative caches have 128 sets of four 16-byte lines. Each set in both caches has a tag (consisting of the upper 21 bits of the physical address), status information, and four long words (128 bits) of data. The status information for the instruction cache is a single valid bit for the line. The status information for the data cache is a valid bit and a dirty

Caches

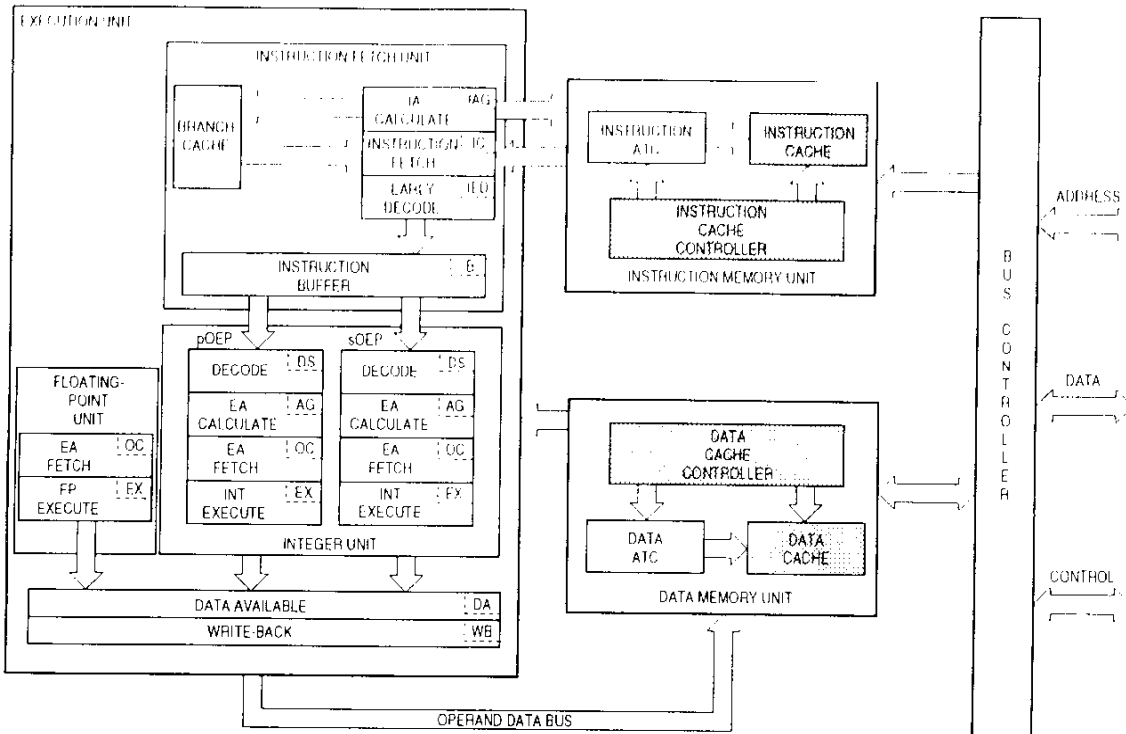

Figure 5-1. MC68060 Instruction and Data Caches

bit for the line. Note that only the data cache supports dirty cache lines. Figure 5-2 illustrates the instruction cache line format and Figure 5-3 illustrates the data cache line format.

TAG	V	LW3	LW2	LW1	LW0
-----	---	-----	-----	-----	-----

WHERE:
 TAG—21-BIT PHYSICAL ADDRESS TAG
 V—VALID BIT FOR LINE
 LW_n—LONGWORD_n (32-BIT) DATA ENTRY

Figure 5-2. Instruction Cache Line Format

TAG	V	D	LW3	LW2	LW1	LW0
-----	---	---	-----	-----	-----	-----

WHERE:
 TAG—21-BIT PHYSICAL ADDRESS TAG
 V—VALID BIT FOR LINE
 D—DIRTY BIT FOR LINE
 LW_n—LONGWORD_n (32-BIT) DATA ENTRY

Figure 5-3. Data Cache Line Format

The cache stores an entire line, providing validity on a line-by-line basis. Only burst mode accesses that successfully read four long words can be cached.

A cache line is always in one of three states: invalid, valid, or dirty. For invalid lines, the V-bit is clear, causing the cache line to be ignored during lookups. Valid lines have their V-bit set and D-bit cleared, the line contains valid data consistent with memory. Dirty cache lines

have the V-bit and D-bit set, indicating that the line has valid entries that have not been written to memory. A cache line changes states from valid or dirty to invalid if the execution of the CINV or CPUSH instruction explicitly invalidates the cache line or if a snoop access hits the cache line. Both caches should be explicitly cleared using the CINVA instruction after a hardware reset of the processor since reset does not invalidate the cache lines.

Figure 5-4 illustrates the general flow of a caching operation. The caches use the physical addresses, and to simplify the discussion, the discussion of the translation of logical to physical addresses is omitted.

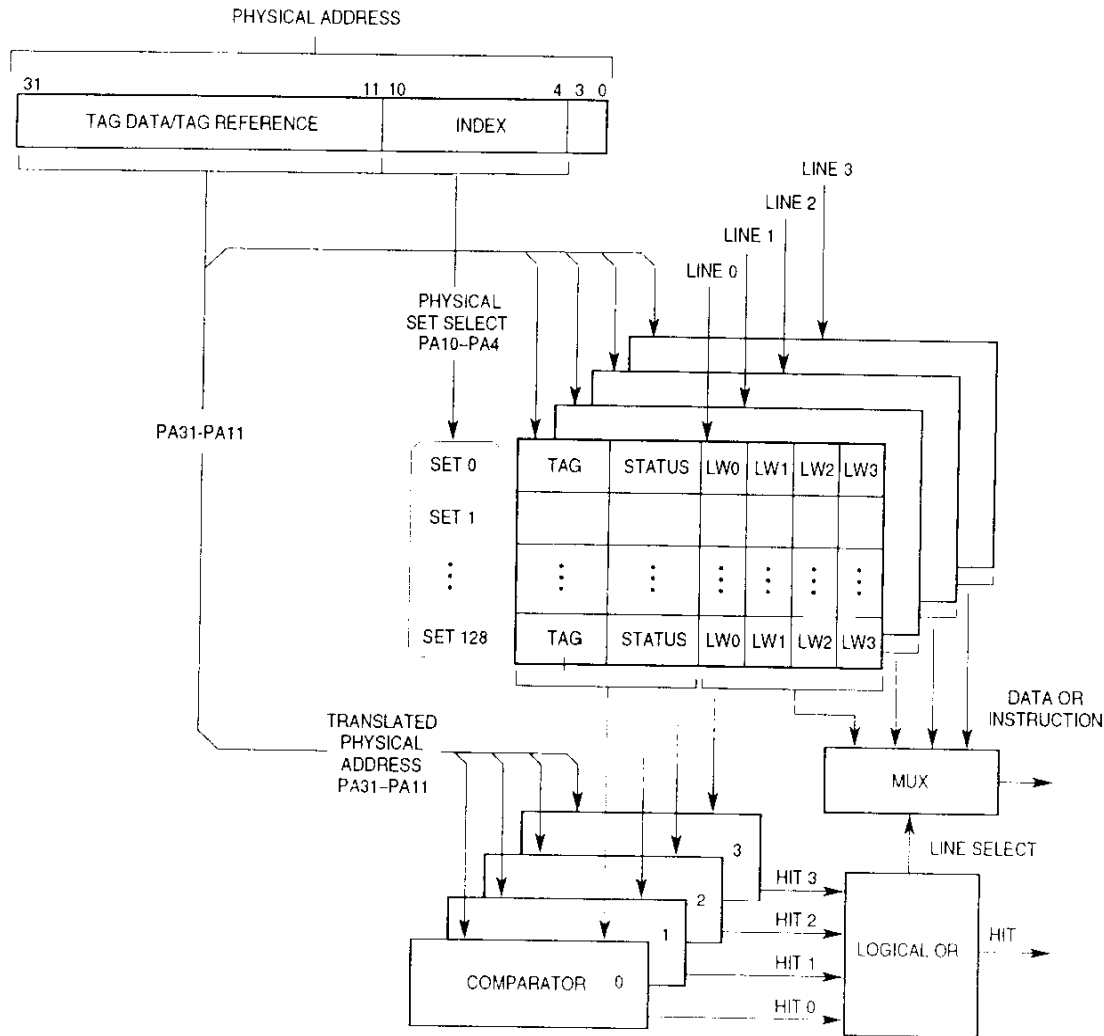

Figure 5-4. Caching Operation

To determine if the physical address is already allocated in the cache, the lower physical address bits 10–4 are used to index into the cache and select 1 of 128 sets of cache lines. Physical address bits 31–11 are used as a tag reference or to update the cache line tag field. The four tags from the selected cache set are compared with the tag reference. If any one of the four tags matches the tag reference and the tag status is either valid or dirty, then

Caches

a cache hit has occurred. A cache hit indicates that the data entries (LW3–LW0) in that cache line contain valid data (for a read access) or is written with new data (for a write access).

To allocate an entry into the cache, the physical address bits 10–4 are used to index into the cache and select one of the 128 sets of cache lines. The status of each of the four cache lines is examined. The cache control logic first looks for an invalid cache line to use for the new entry. If no invalid cache lines are available, then one of the four cache lines must be deallocated to host the new entry. The cache controller uses a pseudo round-robin replacement algorithm to determine which cache line will be deallocated and replaced.

5

In the process of deallocation, a cache line that is valid and not dirty is invalidated. A dirty cache line is placed in a push buffer (to do an external cache line write push) before being invalidated. Once a cache line is invalidated, it is replaced with the new entry.

When a cache line is selected to host a new cache entry, the new physical address bits 31–11 are written to the tag, the data bits LW3–LW0 are updated with the new memory data, and the cache line status is changed to a valid state. Allocating a new entry into the cache is always associated with a visible cache line read bus cycle externally.

Read cycles that miss in the cache allocate normally as described in the previous paragraphs. Write cycles that miss in the cache do not allocate on a cachable writethrough page, but do allocate on a cachable copyback page. The allocation process initiates a line read to allocate a valid entry in the cache as previously described, and is immediately followed by a write to the newly allocated cache line changing the cache line status to dirty. No external write to memory occurs.

Read hits do not change the cache status of the cache line that hit and no deallocation and replacement occurs. Write hits on cachable writethrough pages perform an external write bus cycle; write hits on cachable copyback pages do not perform an external bus cycle.

If the instruction cache hits on an instruction fetch access, one long word is driven onto the internal instruction data bus. If the operand data cache hits on an operand read access, 32-bits or 64-bits (for double-precision floating-point accesses) are driven onto the internal operand data bus. If the data cache hits on a write access, the data is written to the appropriate portion of the accessed cache line. If the data access is misaligned, then the operand cache controller breaks up the access into a sequence of smaller aligned fetches to the data cache. Any misaligned operand reference generates at least two cache accesses. Since the entry validity is provided only on a line basis, the entire line must be loaded from system memory on a cache miss in order for a cache to be able to contain any valid information for that line address.

Non-cachable addresses (i.e., those designated as cache inhibited by the memory management unit (MMU) page descriptor or transparent translation register) bypass the cache to allow support for I/O, etc. Valid data cache entries that match during non-cachable address accesses are pushed and invalidated if dirty and are invalidated if not dirty.

Operands of locked instructions (CAS and TAS) and operand references while the lock bit in the bus control register is set which miss in the data cache do not allocate for reads or

writes regardless of the caching mode, and therefore will bypass the cache. Locked instructions that hit in the data cache invalidate a matching valid entry or will push and invalidate a matching dirty entry. The locked operand access will then bypass the cache.

5.2 CACHE CONTROL REGISTER

The cache control register (CACR) is a 32-bit register which contains control information for the instruction and data caches. A MOVEC sets all of the bits in the CACR. A hardware reset clears the CACR, disabling both caches; however, reset does not affect the tags, state information, and data within the caches. The CACR is illustrated in Figure 5-5.

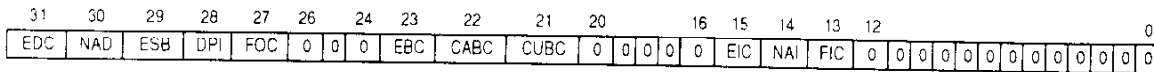

Figure 5-5. Cache Control Register



EDC—Enable Data Cache

- 0 = Data cache is disabled.
- 1 = Data cache is enabled.

NAD—No Allocate Mode (Data Cache)

- 0 = Read and write misses will allocate in the data cache.
- 1 = Read and write misses will not allocate in the data cache.

ESB—Enable Store Buffer

- 0 = All writes to writethrough or cache-inhibited imprecise pages will bypass the store buffer and generate bus cycles directly.
- 1 = The four entry first-in-first-out (FIFO) store buffer to the MC68060 is enabled. This buffer is used to defer pending writes to writethrough or cache-inhibited imprecise pages to maximize performance.

Locked write accesses and accesses to cache-inhibited precise pages always bypass the store buffer.

DPI—Disable CPUSH Invalidation

- 0 = Each cache line is invalidated as it is pushed. Affects only the data cache.
- 1 = CPUSHed lines remain valid in the cache.

FOC—1/2 Cache Operation Mode Enable (Data Cache)

- 0 = The data cache operates in normal, full-cache mode.
- 1 = The data cache operates in 1/2-cache mode.

Bits 26–24—Reserved.

EBC—Enable Branch Cache

- 0 = The branch cache is disabled and branch cache information is not used in the branch prediction strategy.
- 1 = The on-chip branch cache is enabled. Branches are cached. A predicted branch executes more quickly, and often can be folded onto another instruction.

Caches

CABC—Clear All Entries in the Branch Cache

This bit is always read as zero.

- 0 = No operation is done on the branch cache.
- 1 = The entire content of the MC68060 branch cache is invalidated.

CUBC—Clear All User Entries in the Branch Cache

This bit is always read as zero.

- 0 = No operation is performed on the branch cache.
- 1 = All user-mode entries in the MC68060 branch cache are invalidated; supervisor-mode branch cache entries remain valid.

Bits 20–16—Reserved.

EIC—Enable Instruction Cache

- 0 = Instruction cache is disabled.
- 1 = Instruction cache is enabled.

NAI—No Allocate Mode (Instruction Cache)

- 0 = Accesses that miss in the instruction cache will allocate.
- 1 = The instruction cache will continue to supply instructions to the processor, but an access that misses will not allocate.

FIC—1/2 Cache Operation Mode Enable (Instruction Cache)

- 0 = The instruction cache operates in normal, full-cache mode.
- 1 = The instruction cache operates in 1/2-cache mode.

Bits 13–0—Reserved.

5.3 CACHE MANAGEMENT

The caches are individually enabled and configured by using the MOVEC instruction to access the CACR. A hardware reset clears the CACR, disabling both caches and removing all configuration information; however, reset does not affect the tags, state information, and data within the caches. The CINV instruction must clear the caches before enabling them. The MC68060 cannot cache page descriptors.

System hardware can assert the cache disable (\overline{CDIS}) signal to dynamically disable the both the instruction and data caches, regardless of the state of the enable bits in the CACR. The caches are disabled immediately after the current access completes. If \overline{CDIS} is asserted during the access for the first half of a misaligned operand spanning two cache lines, the data cache is disabled for the second half of the operand. Internal accesses always bypass the instruction and data caches while \overline{CDIS} is recognized, and the contents of the caches are unchanged. Disabling the caches with \overline{CDIS} does not affect snoop operations. \overline{CDIS} is intended primarily for use by in-circuit emulators to allow swapping between the tags and emulator memories.

The privileged CINV and CPUSH instructions support cache management, by selectively pushing and/or invalidating an individual cache line, a full page, or an entire cache, for either



or both instruction and data caches. CINV allows selective invalidation of cache entries. The CPUSH instruction will either push and invalidate all matching lines, or push and leave the line valid, depending on the state of the DPI bit of the CACR register. (Note that only CPUSH instructions which specify the data cache are affected by the DPI bit. Since the instruction cache cannot have dirty data, a CPUSH specifying the instruction cache is interpreted as a CINV instruction.) Because of the size of the caches, pushing pages or an entire cache may incur a significant time penalty. Therefore, the CPUSH instruction may be interrupted to avoid large interrupt latencies. The state of the $\overline{\text{CDIS}}$ signal or the cache enable or no-allocate bits in the CACR does not affect the operation of CINV and CPUSH.

5.4 CACHING MODES

Every cache access has an associated caching mode from the MMU that determines how the cache handles the access. An access can be cachable in either the writethrough or copyback modes, or it can be cache inhibited in precise or imprecise modes. The CM field (from the transparent translation register (TTR) or MMU translation table page descriptor) corresponding to the logical address of the access normally specifies, on a page-by-page basis, one of these caching modes. When the cache is enabled and memory management is disabled, the default caching mode is writethrough.

The MMU provides the cache mode user page attributes (UPAx) and write protection for each access. This information may come from a TTR which matches or from the MMU translation tables via the ATC. If both the TTR and the ATC match the access, the TTR provides the information. If the paging MMU is disabled (TCR bit clear) and neither TTR matches, then the cache mode, UPAx, and write protection will be that which is specified in the default bits of the TCR. After reset, the defaults are writethrough cache mode, UPAx bits are zero, and all addresses may be written.

The TTRs and MMUs allow the defaults to be overridden. In addition, some instructions and integer unit operations perform data accesses that have an implicit caching mode associated with them. The following paragraphs discuss the different caching accesses and their related cache modes.

5.4.1 Cachable Accesses

If the CM field of a page descriptor, TTR, or default field of the TCR indicates writethrough or copyback, then the access is cachable. A read access to a writethrough or copyback page is read from the cache if matching data is found. Otherwise, the data is read from memory and used to update the cache. Since instruction cache accesses are always reads, the selection of writethrough or copyback modes do not affect them. The following paragraphs describe the writethrough and copyback modes in detail.

5.4.1.1 WRITETHROUGH MODE. Accesses to pages specified as writethrough are always written to the external address, although the cycle can be buffered (depending on the state of the ESB bit in the CACR). Writes in writethrough mode are handled with a no-write-allocate policy—i.e., writes that miss in the data cache are written to memory or the write buffer, but do not cause the corresponding line in memory to be loaded into the cache. Write accesses that hit always write through to memory and update matching cache lines. Specifying writethrough mode for the shared pages maintains cache coherency for shared mem-

Caches

ory areas in a multiprocessing environment. The cache supplies data to instruction or data read accesses that hit in the appropriate cache; misses cause a new cache line to be loaded into the cache, unless no-allocate mode is selected (NAD or NAI is set) via the CACR.

5.4.1.2 COPYBACK MODE. Copyback pages are typically used for local data structures or stacks to minimize external bus usage and reduce write access latency. Write accesses to pages specified as copyback that hit in the data cache update the cache line and set the corresponding D-bit without an external bus access. The dirty cached data is only written to memory if the line is replaced due to a miss, or a writethrough or cache-inhibited access which hits the dirty line, or a CPUSH which pushes the line. If a write access misses in the cache, then the needed cache line is read from memory and the cache is updated if the NAD bit in the CACR is clear. If a write miss occurs when the NAD bit is set, the cache is not updated. When a miss causes a dirty cache line to be selected for replacement, the current cache line data is moved to the push buffer. The replacement line is read into the cache, and the push buffer contents are written to external memory.

5.4.2 Cache-Inhibited Accesses

Address space regions containing targets such as I/O devices and shared data structures in multiprocessing systems can be designated cache inhibited. If a page descriptor's CM field indicates precise or imprecise, then the access is cache inhibited. The caching operation is identical for both cache-inhibited modes. The difference between these inhibited cache modes has to do with recovery from an exception (either external bus error, or interrupt).

If the CM field of a matching address indicates either precise or imprecise modes, the cache controller bypasses the cache and performs an external bus transfer. The data associated with the access is not cached internally, and the cache inhibited out (\overline{CIOUT}) signal is asserted during the bus cycle to indicate to external memory that the access should not be cached. If the data cache line is already resident in an internal cache and the current cache mode for that page becomes cache inhibited, either through an operating system change, or due to a shared physical page, then the caches provide additional support for cache coherency, by pushing the line if dirty or invalidating the line if it is valid.

If the CM field indicates precise mode, then the sequence of read and write accesses to the page is guaranteed to match the sequence of the instruction order. In imprecise mode, the operand pipeline allows read accesses that hit in the cache to occur before completion of a pending write from a previous instruction. Writes will not be deferred past operand read accesses that miss in the cache (i.e. that must be read from the bus). Precise operation forces operand read accesses for an instruction to occur only once by preventing the instruction from being interrupted after the operand fetch stage. Otherwise, if not in precise mode and an exception occurs, the instruction is aborted, and the operand may be accessed again when the instruction is restarted. These guarantees apply only when the CM field indicates the precise mode and the accesses are aligned. Regardless of the selected cache mode, locked accesses are implicitly precise. Locked accesses are performed by the MC68060 for the operands of the TAS and CAS instructions, and for updating history information in the translation tables during table search operations.

5.4.3 Special Accesses

Several other processor operations result in accesses that have special caching characteristics besides those with an implied cache-inhibited access in the precise mode. Exception stack accesses and exception vector fetches that miss in the cache do not allocate cache lines in the data cache, preventing replacement of a cache line. Cache hits by these accesses are handled in the normal manner according to the caching mode specified for the accessed address.

MC68060-initiated MMU table searches bypass the cache.

Accesses by the MOVE16 instruction also do not allocate cache lines in the data cache for either read or write misses. Read hits on either valid or dirty cache lines are read from the cache. Write hits invalidate a matching line and perform an external access. Interacting with the cache in this manner prevents a large block move or block initialization implemented with a MOVE16 from being cached, since the data may not be needed immediately.

5

5.5 CACHE PROTOCOL

The cache protocol for processor and snoop accesses is described in the following paragraphs. In all cases, an external bus transfer will cause a cache line state to change only if the bus transfer is marked as snoopable on the bus by asserting the $\overline{\text{SNOOP}}$ signal. The protocols described in the following paragraphs assume that the data is cachable (i.e., writethrough and copyback).

5.5.1 Read Miss

A processor read that misses in the cache causes the cache controller to request a bus transaction that reads the needed line from memory and supplies the required data to the integer unit. The line is placed in the cache in the valid state, unless the no-allocate bit (NAD for the data cache or NAI for the instruction cache) for the corresponding cache in the CACR is set. Snooped external reads that miss in the cache have no affect on the cache.

5.5.2 Write Miss

The cache controller handles processor writes that miss in the cache differently for writethrough and copyback pages. Write misses to copyback pages cause a line read from the external bus to load the cache line (unless the corresponding no-allocate bit, NAD or NAI, in the CACR is set). The new cache line is then updated with the write data, and the D-bit for the line is set, leaving the cache line in the dirty state. Write misses to writethrough pages write directly to memory without loading the corresponding cache line in the cache. Snooped external writes that miss in the cache have no affect on the cache.

5.5.3 Read Hit

On a read hit, the appropriate cache provides the data to the requesting pipe unit. In most cases no bus transaction is performed, and the state of the cache line does not change. However, when a writethrough read hit to a line containing dirty data occurs, the dirty line is pushed and the cache line state changes to valid before the data is provided to the requesting pipe unit.

Caches

A snooped external read hit invalidates the cache line that is hit.

5.5.4 Write Hit

The cache controller handles processor writes that hit in the cache differently for writethrough and copyback pages. For write hits to a writethrough page, the portions of the cache line(s) corresponding to the size of the access are updated with the data, and the data is also written to external memory. The cache line state does not change. A writethrough access to a line containing dirty data results in the dirty line being pushed and then written to memory. If the access is copyback, the cache controller updates the cache line and sets the D-bit for the line. An external write is not performed, and the cache line state changes to, or remains in, the dirty state.

An alternate bus master can assert the $\overline{\text{SNOOP}}$ signal for a write that it initiates, which will invalidate any corresponding entry in the internal cache.

5.6 CACHE COHERENCY

The MC68060 provides several different mechanisms to assist in maintaining cache coherency in multimaster systems. Both writethrough and copyback memory update techniques are supported to maintain coherency between the data cache and memory.

Alternate bus master accesses can reference data that the MC68060 may have cached, causing coherency problems if the accesses are not handled properly. The MC68060 snoops the bus during alternate bus master transfers if $\overline{\text{SNOOP}}$ is asserted. Snoop hits invalidate the cache line in all cases (read, write, long word, word, byte) for MOVE16 and normal accesses. Since the processor may be accessing data in its caches even when it does not have the bus, a snoop has priority over the processor, to maintain cache coherency.

The snooping protocol and caching mechanism supported by the MC68060 requires that pages shared with any other bus master be marked cachable writethrough or cache inhibited (either precise or imprecise). This procedure allows each processor to cache shared data for read access while forcing a processor write to shared data to appear as an external write to memory, which the other processors can snoop. If shared data is stored in copyback pages, cache coherency is not guaranteed.

Coherency between the instruction cache and the data cache must be maintained in software since the instruction cache does not monitor data accesses. Processor writes that modify code segments (i.e., resulting from self-modifying code or from code executed to load a new page from disk) access memory through the data memory unit. Because the instruction cache does not monitor these data accesses, stale data occurs in the instruction cache if the corresponding data in memory is modified. Invalidating instruction cache lines before writing to the corresponding memory lines can prevent this coherency problem, but only if the data cache line is in writethrough or cache-inhibited mode. A cache coherency problem could arise if the data cache line is configured as copyback.

To fully support self-modifying code in any situation, it is imperative that a CPUSHA instruction specifying both caches be executed before the execution of the first self-modified

instruction. The CPUSHA instruction has the effect of ensuring that there is no stale data in memory, the pipeline is flushed, and instruction prefetches are repeated and taken from external memory.

5.7 MEMORY ACCESSES FOR CACHE MAINTENANCE

The cache controller in each memory unit performs all maintenance activities that supply data from the cache to the instruction and operand pipeline units. The activities include requesting accesses to the bus interface unit for reading new cache lines and writing dirty cache lines to memory. The following paragraphs describe the memory accesses resulting from cache fill operations (by both caches) and push operations (by the data cache). Refer to **Section 7 Bus Operation** for detailed information about the bus cycles required.

5

5.7.1 Cache Filling

When a new cache line is required, the cache controller requests a line read from the bus controller. The bus controller requests a burst read transfer by indicating a line access with the size signals (SIZ1, SIZ0) and indicates which line in the set is being loaded with the transfer line number signals (TLN1, TLN0). TLN1 and TLN0 are undefined for the instruction cache. These pins indicate the appropriate line numbers for cache transfers. Table 5-1 lists the definition of the TLNx encoding.

Table 5-1. TLNx Encoding

TLN1	TLN0	Line
0	0	Zero
0	1	One
1	0	Two
1	1	Three

The responding device sequentially supplies four long words of data and can assert the transfer cache inhibit signal ($\overline{\text{TCI}}$) if the line is not cachable. If the responding device does not support the burst mode, it should assert the $\overline{\text{TBI}}$ signal for the first long word of the line access. The bus controller responds by terminating the line access and completes the remainder of the line read as three, sequential, long-word reads.

Bus controller line accesses implicitly request burst mode operations from external memory. To operate in the burst mode, the device or external hardware must be able to increment the low-order address bits as described in **Section 7 Bus Operation**. The device indicates its ability to support the burst access by acknowledging the initial long-word transfer with transfer acknowledge ($\overline{\text{TA}}$) asserted and $\overline{\text{TBI}}$ negated. This procedure causes the processor to continue to drive the address and bus control signals and to latch a new data value for the cache line at the completion of each subsequent cycle (as defined by $\overline{\text{TA}}$) for a total of four cycles. The bursting mechanism requires addresses to wrap around so that the entire four long words in the cache line are filled in a single operation.

When a cache line read is initiated, the first cycle attempts to load the line entry corresponding to the address requested by the IFU. Subsequent transfers are for the remaining entries in the cache line. In the case of a misaligned access in which the operand spans two line

Caches

entries, the first cycle corresponds to the line entry containing the portion of the operand at the lower address.

Line read data is handled differently by the instruction cache and the data cache. In the instruction cache, the first long word fetched is immediately available to the IFU. It is also put in a line read buffer. The data for the rest of the line is also put in this buffer as it is received. If subsequent IFU requests are sequential and within the address range in the line read buffer, these requests hit in the instruction read buffer as data becomes available. If subsequent IFU requests are not sequential, or are outside the address range in the read buffer, the IFU stalls until the line is completely fetched. In the data cache, the first long word or first two long words are available to the integer or floating-point units. The amount of data which is available immediately depends on the size and alignment of the operation that initiated the cache miss. These long words along with the remainder of the line fetch are also put in the data line read buffer. All subsequent data cache requests stall until the line is completely fetched. A misaligned access which spans two cache lines is handled by the data cache unit as two separate accesses.

5

The assertion of $\overline{\text{TCI}}$ during the first cycle of a burst read operation inhibits loading of the buffered line into the cache, but it does not cause the burst transfer (or pseudo-burst transfer if $\overline{\text{TBI}}$ is asserted with $\overline{\text{TCI}}$) to be terminated early. If $\overline{\text{TCI}}$ is asserted during the first data transfer cycle for a read operand, the initial bypass of data for both instruction and data accesses takes place normally, as described above in the paragraph on line reads. The line read buffers in both caches are filled normally. The instruction cache unit will allow sequential access in the address range of the line read buffer until the last long word of the burst is transferred from the bus controller. No additional data from the line is available from the data cache unit. When the line fetch is completed, the contents of both line buffers are discarded. No data is transferred to either cache memory. The assertion of $\overline{\text{TCI}}$ is ignored during the second, third, or fourth cycle of a burst operation and is ignored for write operations.

A bus error occurring during a burst operation causes the burst operation to abort. If the bus error occurs during the first cycle of a burst, the data from the bus is ignored. If the access is a data cycle, exception processing proceeds immediately. If the cycle is for an instruction prefetch, a bus error exception is not taken immediately, but will be taken if the instruction flow subsequently causes the instruction to be attempted. Refer to **Section 7 Bus Operation** for more information about pipeline operation.

For either cache, when a bus error occurs on the second cycle or later, the burst operation is aborted and the line buffer is invalidated. The processor may or may not take an exception, depending on the status of the pending data request. If the bus error cycle contains a portion of a data operand that the processor is specifically waiting for (e.g., the second half of a misaligned operand), the processor immediately takes an exception. Otherwise, no exception occurs, and the cache line fill is repeated the next time data within the line is required. In the case of an instruction cache line fill, the unneeded data from the aborted cycle is completely ignored.

The MC68060 supports native retry functionality using the $\overline{\text{TRA}}$ signal, as well as MC68040-compatible retry functionality using $\overline{\text{TA}}$ and $\overline{\text{TEA}}$. The MC68040-compatible retry functions as the 040. For either type, on the initial access of a line read, a retry termination causes a

retry of the bus cycle. A MC68040-compatible retry signaled during the remaining cycles of the line access (either burst or pseudo-burst) is recognized as a bus error, and the processor handles it as described in the previous paragraphs. Assertion of the $\overline{\text{TRA}}$ signal (native retry) during the remaining cycles of the line access is ignored.

5.7.2 Cache Pushes

When the cache controller selects a dirty data cache line for replacement, memory must be updated with the dirty data before the line is replaced. Cache pushes occur for line replacement, as required for the execution of the CPUSH instruction, and when a writethrough or cache-inhibited access hits a dirty cache line. To reduce the requested data's latency in the new line, the dirty line being replaced is temporarily placed in a push buffer while the new line is fetched from memory. When a line is allocated to the push buffer, an alternate bus master can snoop it, but the execution units cannot access it. After the bus transfer for the new line successfully completes, the dirty cache line is copied back to memory, and the push buffer is invalidated. If the operation to access the replacement line is abnormally terminated or the external cache inhibit signal is asserted, the line in the push buffer is restored back into its original position in the cache and validated.

A cache line is written to memory using a line push transfer if it is dirty. A push transfer is distinguished from a normal write transfer by an encoding of 000 on the transfer modifier signals (TM2–TM0) for the push. Refer to **Section 8 Exception Processing** for information on the case of a bus error terminating a push transfer.

A dirty cache line hit by a cache-inhibited access is pushed before the external bus access occurs.

5.8 PUSH BUFFER

The MC68060 processor implements a push buffer to reduce latency for requested new data on a cache miss by temporarily putting displaced dirty data into the push buffer while the new data is fetched from memory. While the dirty line resides in the push buffer, it can be snooped by an external bus master. The push buffer contains 16 bytes of storage (one displaced cache line).

If a data cache miss displaces a dirty line, the miss reference is immediately placed on the system bus. While waiting for the response, the current contents of the data cache location are loaded into the push buffer. Once the bus transaction (burst read) completes, the MC68060 is able to generate the appropriate line write bus transaction to store the contents of the push buffer into memory.

5.9 STORE BUFFER

The MC68060 processor provides a four-entry store buffer (16 bytes maximum). This store buffer is a FIFO buffer that can be used for deferring pending writes to imprecise pages to maximize performance.

For operand writes destined for the store buffer, the operand execution pipeline incurs no stalls. The store buffer effectively provides a measure of decoupling between the pipeline's ability to generate writes (one write per cycle maximum) and the ability of the system bus to

Caches

retire those writes (one write per two cycles minimum). When writing to imprecise pages, only in the event the store buffer becomes full and there is a write operation in the EX cycle of the operand execution pipeline will a stall be incurred.

If the store buffer is not utilized (store buffer disabled or cache inhibited, precise mode), system bus cycles are generated directly for each pipeline write operation. The instruction is held in the EX cycle of the operand execution pipeline (OEP) until bus transfer termination is received. This means each write operation is stalled for a minimum of five cycles in the EX cycle when the store buffer is not utilized.

5

A store buffer enable bit is contained in the CACR. This bit can be set and cleared via the MOVEC instruction. Upon reset, this bit is cleared and all writes are precise. When the bit is set, the cache mode generated by the MMU is used. The store buffer is utilized by the cacheable/writethrough and the cache-inhibited/imprecise modes.

The store buffer can queue data up to four bytes in width per entry. Each entry matches a corresponding bus cycle it will generate; therefore, a misaligned long-word write to a writethrough page will create two entries if the address is to an odd word boundary, three entries if to an odd byte boundary—one per bus cycle.

A misaligned write access which straddles a precise/imprecise page boundary will use the store buffer for the imprecise portion of the write.

5.10 PUSH BUFFER AND STORE BUFFER BUS OPERATION

Once either the store buffer or the push buffer has valid data, the MC68060 bus controller uses the next available bus cycle to generate the appropriate write cycles. In the event that during the continued instruction execution by the processor pipeline another system bus cycle is required (e.g., data cache miss to process, address translation cache (ATC) tablesearch to perform), the pipeline will stall until both push and store buffers are empty before generating the required system bus transaction.

Certain instructions and exception processing which synchronize the MC68060 processor pipeline guarantee both push and store buffers are empty before proceeding.

5.11 BRANCH CACHE

The branch cache plays a major role in achieving the performance levels of the MC68060 processor. The branch cache provides a table associating branch program counter values with the corresponding branch target virtual addresses. The fundamental concept is to provide a mechanism that allows the instruction fetch pipeline to detect and change instruction streams before the change-of-flow instructions enter an operand execution pipeline.

The branch cache implementation is made up of a five-state prediction model based on past execution history, in addition to the current program counter/branch target virtual address association logic.

For each instruction fetch address generated, the branch cache is examined to see if a valid branch entry is present. If there is not a branch cache hit, the instruction fetch unit continues to fetch instructions sequentially. If a branch cache hit occurs indicating a “taken branch”.

the instruction fetch unit discards the current instruction stream and begins fetching at the location indicated by the branch target address. As long as the branch cache prediction is correct, which happens a very significant percentage of the time, the change-of-flow of the instruction stream is "invisible" to the OEP and performance is maximized. If the branch cache prediction is wrong, the internal pipelines are "cancelled" and the correct instruction flow is established.

The branch cache must be cleared by the operating system on all context switches (using the MOVEC to CACR instruction), because it is virtually-mapped.

The branch cache is automatically cleared by the hardware as part of any cache invalidate (CINV) or any cache push and invalidate (CPUSH) instruction operating on the instruction cache.

Programs that use the TRAPF instruction extension word as a possible branch target destination interfere with proper operation of the branch target cache, resulting in an access error exception. This condition is indicated by the BPE bit in the FSLW of the access error stack.

5

5.12 CACHE OPERATION SUMMARY

The instruction and data caches function independently when servicing access requests from the integer unit. The following paragraphs discuss the operational details for the caches and present state diagrams depicting the cache line state transitions.

5.12.1 Instruction Cache

The integer unit uses the instruction cache to store instruction prefetches as it requests them. Instruction prefetches are normally requested from sequential memory locations except when a change of program flow occurs (e.g., a branch taken) or when an instruction that can modify the status register (SR) is executed, in which case the instruction pipe is automatically flushed and refilled. The instruction cache supports a line-based protocol that allows individual cache lines to be in either the invalid or valid states.

For instruction prefetch requests that hit in the cache, the long word containing the instruction is placed onto the internal instruction data bus. When an access misses in the cache, the cache controller requests the line containing the required data from memory and places it in the cache. If available, an invalid line is selected and updated with the tag and data from memory. The line state then changes from invalid to valid by setting the V-bit. If all lines in the set are already valid, a pseudo round-robin replacement algorithm is used to select one of the four cache lines replacing the tag and data contents of the line with the new line information. Figure 5-6 illustrates the instruction-cache line state transitions resulting from processor and snoop controller accesses. Transitions are labeled with a capital letter, indicating the previous state, followed by a number indicating the specific case listed in Table 5-2.

Caches

Table 5-2. Instruction Cache Line State Transitions

Cache Operation	Current State			
	Invalid Cases		Valid Cases	
IPU Read Miss	I1	Read line from memory; supply data to IPU and update cache; go to valid state.	V1	Read line from memory; supply data to IPU and update cache (replacing old line); remain in current state.
IPU Read Hit	I2	Not Possible.	V2	Supply data to IPU; remain in current state.
Cache Invalidate or Push (CINV or CPUSH)	I3	No action; remain in current state.	V3	No action; go to invalid state.
Alternate Master Snoop Hit (Read or Write)	I4	Not possible.	V4	No action; go to invalid state.
Alternate Master Snoop Miss	I5	Not possible.	V5	No action; remain in current state.
TCl Asserted on Read Miss (during the First Access)	I6	Read line for memory; Supply data to the IPU; remain in current state.	V6	Not Possible.

5

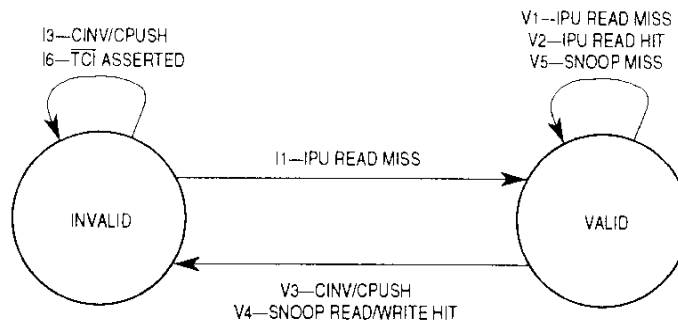

Figure 5-6. Instruction Cache Line State Diagram

5.12.2 Data Cache

The integer unit uses the data cache to store operand data as it requires or generates the data. The data cache supports a line-based protocol allowing individual cache lines to be in one of three states: invalid, valid, or dirty. To maintain coherency with memory, the data cache supports both writethrough and copyback modes, specified by the CM field for the page.

Read misses and write misses to copyback pages cause the cache controller to read a new cache line from memory into the cache. If available, an invalid line in the selected set is updated with the tag and data from memory. The line state then changes from invalid to valid by setting the V-bit for the line. If all lines in the set are already valid or dirty, the pseudo round-robin replacement algorithm is used to select one of the four lines and replace the tag and data contents of the line with the new line information. Before replacement, dirty lines are temporarily buffered and later copied back to memory after the new line has been read from memory. Snoops always check both the push buffer and the cache. Figure 5-7 illustrates the three possible states for a data cache line, with the possible transitions caused by either the processor or snooped accesses. Transitions are labeled with a capital letter, indicating the previous state, followed by a number indicating the specific case listed in Table 5-3.

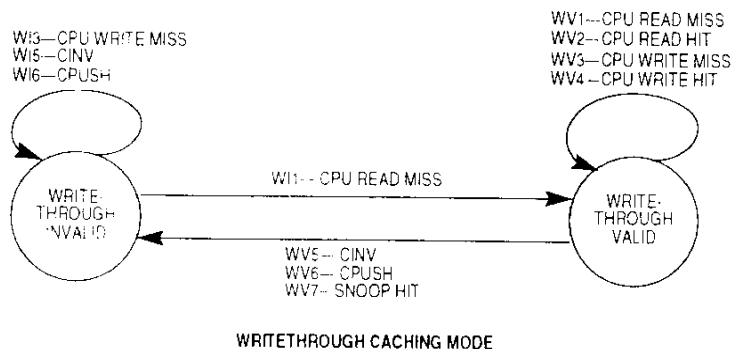
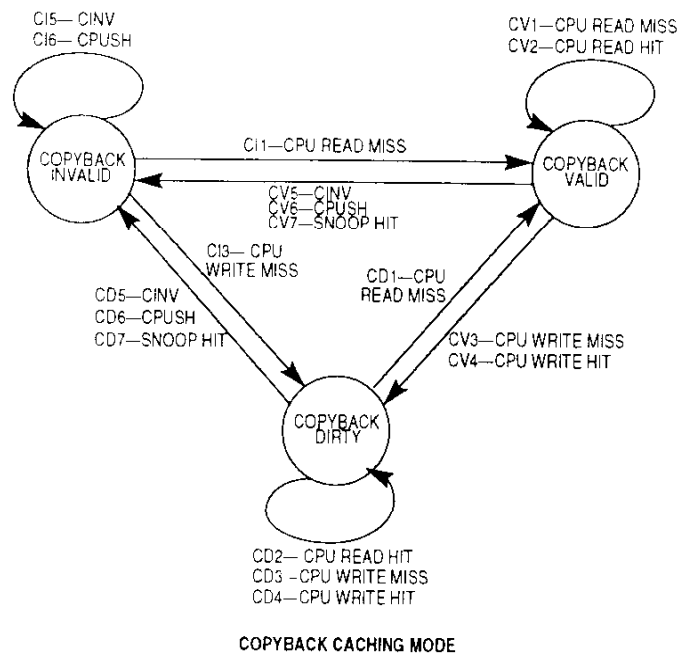

Figure 5-7. Data Cache Line State Diagrams

Caches

Table 5-3. Data Cache Line State Transitions

Cache Operation	Current State					
	Invalid Cases		Valid Cases		Dirty Cases	
OPU Read Miss	(C,W)I1	Read line from memory and update cache; Supply data to OPU; Go to valid state.	(C,W)V1	Read new line from memory and update cache; supply data to OPU; Remain in current state.	CD1	Push dirty cache line to push buffer; Read new line from memory and update cache; Supply data to OPU; Write push buffer contents to memory; Go to valid state.
OPU Read Hit	(C,W)I2	Not possible.	(C,W)V2	Supply data to OPU; Remain in current state.	CD2	Supply data to OPU; Remain in current state.
OPU Write Miss (Copyback Mode)	CI3	Read line from memory and update cache; Write data to cache; Go to dirty state.	CV3	Read new line from memory and update cache; Write data to cache; Go to dirty state.	CD3	Push dirty cache line to push buffer; Read new line from memory and update cache; Write push buffer contents to memory; Remain in current state.
OPU Write Miss (Writethrough Mode)	WI3	Write data to memory; Remain in current state.	WV3	Write data to memory; Remain in current state.	WD3	Write data to memory; Remain in current state.
OPU Write Hit (Copyback Mode)	CI4	Not possible.	CV5	Write data to cache; Go to dirty state.	CD4	Write data to cache; Remain in current state.
OPU Write Hit (Writethrough Mode)	WI4	Not possible.	WV4	Write data to memory and to cache; Remain in current state.	WD4	Push dirty cache line to memory; Write data to memory and to cache; Go to valid state.
Cache Invalidate	(C,W)I5	No action; Remain in current state.	(C,W)V5	No action; Go to invalid state.	CD5	No action (dirty data lost); Go to invalid state.
Cache Push	(C,W)I6	No action; Remain in current state.	(C,W)V6	No action; Go to invalid state.	CD6	Push dirty cache line to memory; Go to invalid state or remain in current state, depending on the DPI bit the the CACR.
Alternate Master Snoop Hit	(C,W)I7	Not possible.	(C,W)V7	No action; Go to invalid state.	CD7	No action (dirty data lost); Go to invalid state.

5

SECTION 6 FLOATING-POINT UNIT

NOTE

This section does not apply to the MC68LC060 or MC68EC060. Refer to **Appendix A MC68LC060** and **Appendix B MC68EC060** for details.

Floating-point math refers to numeric calculations with a variable decimal point location. It is distinguished from integer math, which deals only with whole numbers and fixed decimal point locations. Historically, general-purpose microprocessors have had to depend on add-on coprocessors and accelerators such as the MC68881/MC68882 for fast floating-point capabilities. The MC68060 features a built-in floating-point unit (FPU). Consolidating this important function on chip speeds up the overall processing and eliminates interfacing overhead required for external accelerators. The MC68060 FPU operates in parallel with the integer unit. The FPU does the numeric calculation while the integer unit performs other tasks. When used with Motorola-supplied emulation software, the M68060 software package (M68060SP), the MC68060 FPU is fully compliant with the *ANSI/IEEE 754–1985 Standard for Binary Floating-Point Arithmetic*.

The on-chip FPU (shown in Figure 6-1) consists of four functional units: FPADD, FPMUL, FPDIV, and FPMISC. These functional units exist in parallel with the integer unit. The decode of floating-point operations is done in the same pipeline stage as integer instructions, and operands are fetched by the same logic which feeds the integer unit. The floating-point functional units are located in the primary pipeline of the integer unit. Only one floating-point functional unit at a time can be active. The FPU allows no concurrency between floating-point instructions to achieve a streamlined floating-point exception model.

The FPADD unit performs floating-point addition and subtraction, compare, absolute value, negate, floating-point to integer and integer to floating-point conversions, and move-in and move-out of floating-point data when the precision and destination are not single, double, or extended precision. Results produced in this unit are rounded to the desired precision and rounding mode. The FPMUL unit performs floating-point multiply and rounding to desired precision and rounding mode. The FPDIV unit performs floating-point divide, square root, and move-in and move-out of floating-point data when the precision and destination are single, double, or extended precision. Results produced in the FDIV unit are rounded to the desired precision and rounding mode. The FPMISC unit handles the remaining functions within the FPU. This includes logic for FSAVE and FRESTORE, logic for FMOVEM, and exception logic. The floating-point control register (FPCR) and floating-point status register (FPSR) reside within this block. All of these functional units access the floating-point register file, which contains the program-visible register set.

Floating-Point Unit

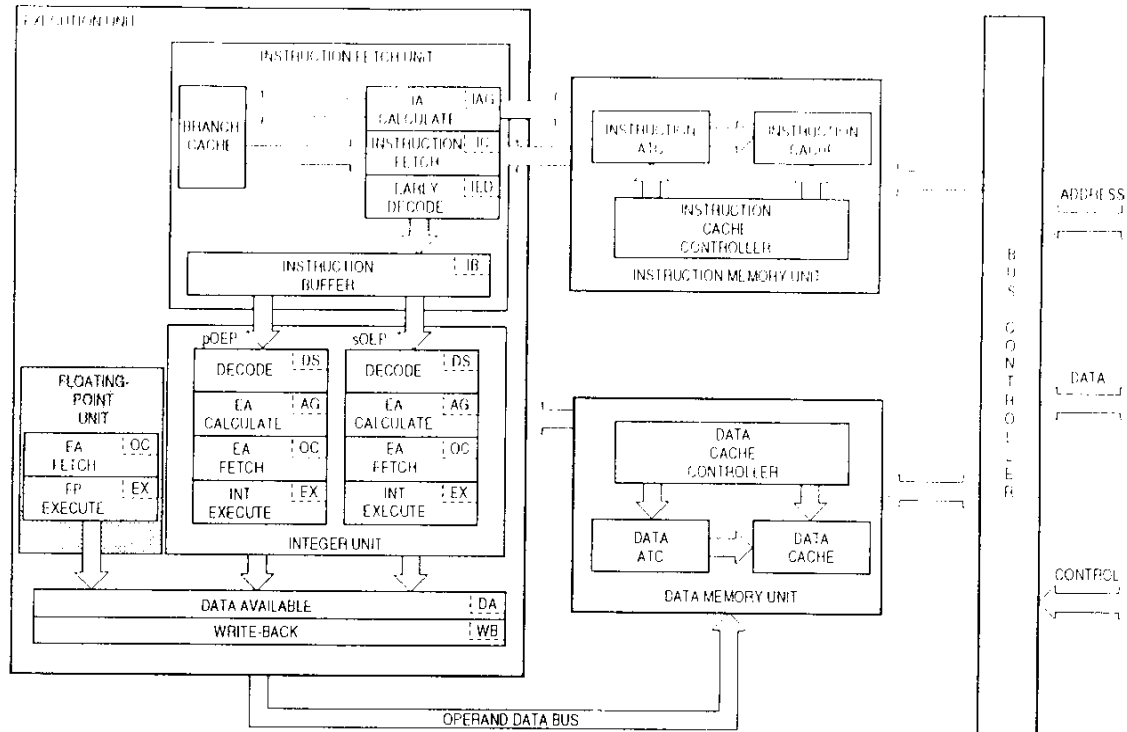

Figure 6-1. Floating-Point Unit Block Diagram

The MC68060 FPU has been optimized for the most frequently used instructions and data types. The MC68060 fully conforms to the *ANSI/IEEE 754-1985 Standard for Binary Floating-Point Arithmetic*. In addition, the MC68060 processor maintains compatibility with the Motorola extended-precision architecture and is user object code compatible with the MC68881/MC68882 floating-point coprocessors and the MC68040 microprocessor FPU. With the inclusion of the M68060SP, the MC68060 provides MC68881/MC68882-compatible software functions. Details on the M68060SP are provided in **Appendix C MC68060 Software Package**.

6.1 FLOATING-POINT USER PROGRAMMING MODEL

Figure 6-2 illustrates the floating-point portion of the user programming model. The following paragraphs describe the FPU portion of the user programming model for the MC68060. The model, which is identical to the programming model for the MC68881/MC68882 floating-point coprocessors, consists of the following registers:

- Eight 80-Bit Floating-Point Data Registers (FP7–FP0)
- 16-Bit Floating-Point Control Register (FPCR)
- 32-Bit Floating-Point Status Register (FPSR)
- 32-Bit Floating-Point Instruction Address Register (FPIAR)

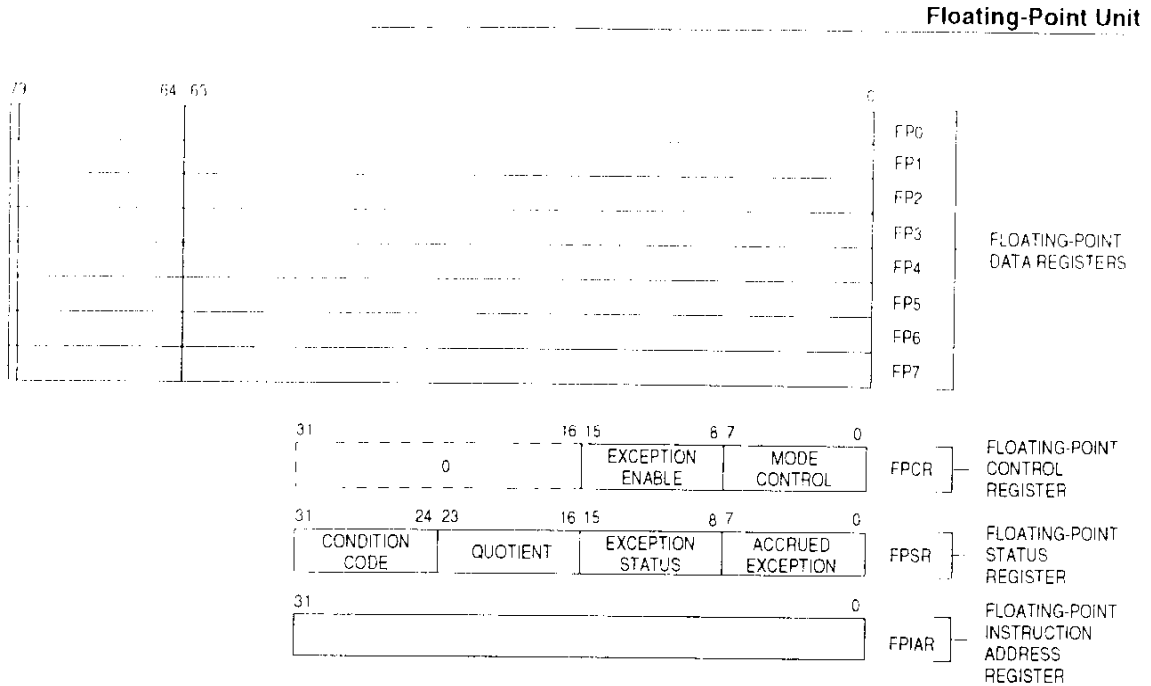

Figure 6-2. Floating-Point User Programming Model

6.1.1 Floating-Point Data Registers (FP7–FP0)

The floating-point data registers are analogous to the integer data registers of the M68000 family. The floating-point data registers always contain extended-precision numbers. All external operands, regardless of the data format, are converted to extended-precision values before being used in any calculation or stored in a floating-point data register. A reset or a restore operation of the null state sets FP7–FP0 to positive, nonsignaling not-a-numbers (NaNs).

6.1.2 Floating-Point Control Register (FPCR)

The FPCR (see Figure 6-3) contains an exception enable (ENABLE) byte that enables or disables traps for each class of floating-point exceptions and a mode control (MODE) byte that sets the user-selectable modes. The user can read or write to the FPCR. Motorola reserves bits 31–16 for future definition; these bits are always read as zero and are ignored during write operations. The reset function or a restore operation of the null state clears the FPCR. When cleared, this register provides the IEEE 754 standard defaults.

6.1.2.1 EXCEPTION ENABLE BYTE. Each bit of the ENABLE byte (see Figure 6-3) corresponds to a floating-point exception class. The user can separately enable traps for each class of floating-point exceptions.

6.1.2.2 MODE CONTROL BYTE. The MODE byte (see Figure 6-3) controls the user-selectable rounding modes and precisions. Zeros in this byte select the IEEE 754 standard defaults. The rounding mode field (RND) specifies how inexact results are rounded, and the rounding precision field (PREC) selects the boundary for rounding the mantissa.

Floating-Point Unit

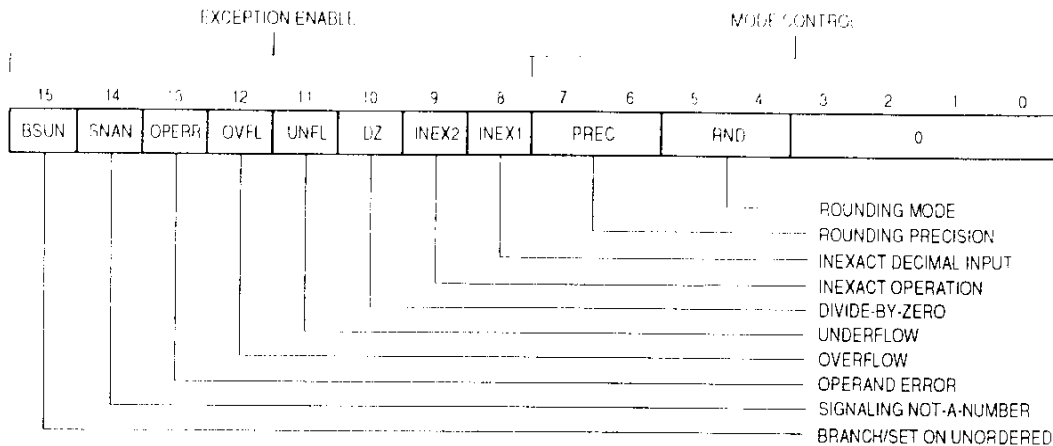

Figure 6-3. Floating-Point Control Register Format

The processor supports four rounding modes specified by the IEEE 754 standard. These modes are round to nearest (RN), round toward zero (RZ), round toward plus infinity (RP), and round toward minus infinity (RM). The RP and RM modes are directed rounding modes that are useful in interval arithmetic. Rounding is accomplished through the intermediate result. Single-precision results are rounded to a 24-bit boundary; double-precision results are rounded to a 53-bit boundary; and extended-precision results are rounded to a 64-bit boundary. Table 6-1 lists the encoding for the rounding mode. Table 6-2 lists the encoding for rounding precision.

Table 6-1. RND Encoding

Encoding		Rounding Mode
0	0	To Nearest (RN)
0	1	Toward Zero (RZ)
1	0	Toward Minus Infinity (RM)
1	1	Toward Plus Infinity (RP)

Table 6-2. PREC Encoding

Encoding		Rounding Precision
0	0	Extend (X)
0	1	Single (S)
1	0	Double (D)
1	1	Undefined

6.1.3 Floating-Point Status Register (FPSR)

The FPSR (see Figure 6-2) contains a floating-point condition code byte (FPCC), a quotient byte, a floating-point exception status byte (EXC), and a floating-point accrued exception byte (AEXC). The user can read or write to all defined bits in the FPSR. Execution of most floating-point instructions modifies this register. The reset function or a restore operation of the null state clears the FPSR. Floating-point conditional operations are not guaranteed if the FPSR is written directly, because the FPSR is only valid as a result of a floating-point instruction.

6.1.3.1 FLOATING-POINT CONDITION CODE BYTE. The FPCC byte (see Figure 6-4) contains four condition code bits that are set at the end of all arithmetic instructions involving the floating-point data registers. These bits are sign of mantissa (N), zero (Z), infinity (I), and NAN. The FMOVE FPM,<ea>, FMOVEM FPM, and FMOVE FPCR instructions do not affect the FPCC.

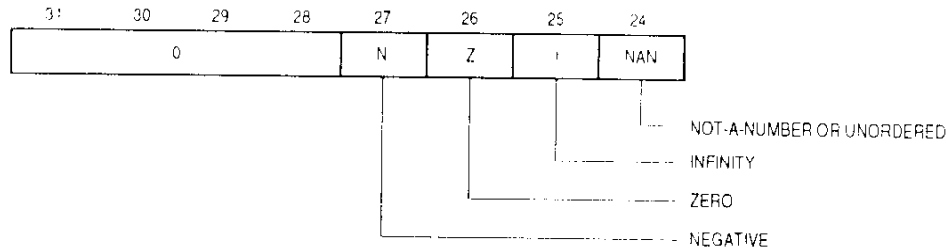

Figure 6-4. Floating-Point Condition Code (FPSR)



To aid programmers of floating-point subroutine libraries, the MC68060 implements the four FPCC bits in hardware instead of only implementing the four IEEE conditions. An instruction derives the IEEE conditions when needed. For example, the programmers of a complex arithmetic multiply subroutine usually prefer to handle special data types, such as zeros, infinities, or NANs, separately from normal data types. The floating-point condition codes allow users to efficiently detect and handle these special values.

6.1.3.2 QUOTIENT BYTE. The quotient byte (see Figure 6-5) provides compatibility with the MC68881/MC68882. This byte is set at the completion of the modulo (FMOD) or IEEE remainder (FREM) instruction, and contains the seven least significant bits of the unsigned quotient as well as the sign of the entire quotient.

The quotient bits can be used in argument reduction for transcendentals and other functions. For example, seven bits are more than enough to determine the quadrant of a circle in which an operand resides. The quotient field (bits 22–16) remains set until the user clears it.

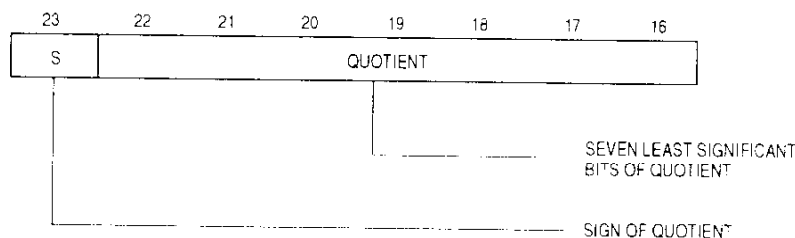

Figure 6-5. Floating-Point Quotient Byte (FPSR)

6.1.3.3 EXCEPTION STATUS BYTE. The EXC byte (see Figure 6-6) contains a bit for each floating-point exception that can occur during the most recent arithmetic instruction or move operation. The start of most operations clears this byte; however, operations that cannot generate floating-point exceptions (the FMOVEM and FMOVE control register instructions) do not clear this byte. An exception handler can use this byte to determine which floating-point exception(s) caused a trap.

Floating-Point Unit

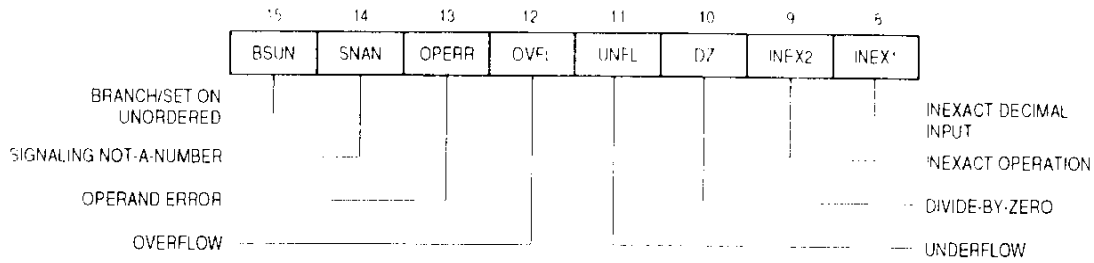

Figure 6-6. Floating-Point Exception Status Byte (FPSR)

6.1.3.4 ACCRUED EXCEPTION BYTE. The AEXC byte contains five exception bits (see Figure 6-7) that the IEEE 754 standard requires for exception-disabled operations. These exceptions are logical combinations of the bits in the EXC byte. The AEXC byte contains the history of all floating-point exceptions that have occurred since the user last cleared the AEXC byte. In normal operations, only the user clears this byte by writing to the FPSR; however, a reset or a restore operation of the null state can also clear the AEXC byte.

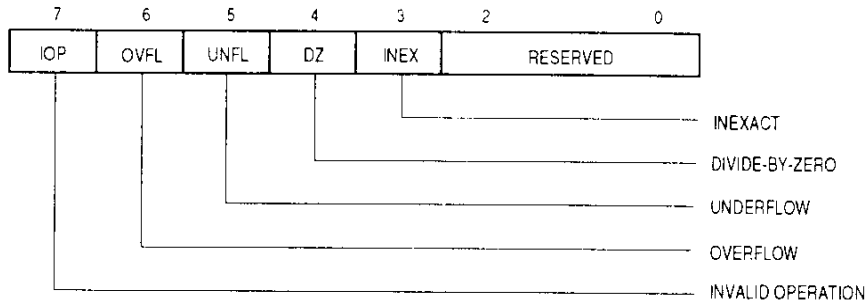

Figure 6-7. Floating-Point Accrued Exception Byte (FPSR)

Many users elect to disable traps for all or part of the floating-point exception classes. The AEXC byte makes it unnecessary to poll the EXC byte after each floating-point instruction. At the end of most operations (FMOVEM and FMOVE excluded), the bits in the EXC byte are logically combined to form an AEXC value that is logically ORed into the existing AEXC byte. This operation creates sticky floating-point exception bits in the AEXC byte that the user needs to poll only once (i.e., at the end of a series of floating-point operations). A sticky bit is one that remains set until the user clears it.

Setting or clearing the AEXC bits neither causes nor prevents an exception. The following equations show the comparative relationship between the EXC byte and AEXC byte. Comparing the current value in the AEXC bit with a combination of bits in the EXC byte derives a new value in the corresponding AEXC bit. These equations apply to setting the AEXC bits at the end of each operation affecting the AEXC byte:

New AEXC Bit	= Old AEXC Bit	+	EXC Bits
IOP	= IOP	+	(BSUN + SNAN + OPERR)
OVFL	= OVFL	+	(OVFL)
UNFL	= UNFL	+	(UNFL • INEX2)
DZ	= DZ	+	(DZ)
INEX	= INEX	+	(INEX1 + INEX2 + OVFL)

6.1.4 Floating-Point Instruction Address Register (FPIAR)

For the subset of the floating-point instructions that generate exception traps, the FPU loads the 32-bit FPIAR with the logical address of the instruction before executing the instruction. Because the integer unit can execute instructions while the FPU executes floating-point instructions, the program counter (PC) value stacked by the MC68060 in response to a floating-point exception handler may not point to the offending instruction. Therefore, a floating-point exception handler uses the address in the FPIAR to locate a floating-point instruction that has caused an exception. Since the FMOVE to/from the FPCR, FPSR, or FPIAR and FMOVEM instructions cannot generate floating-point exceptions, these instructions do not modify the FPIAR. However, they can be used to read the FPIAR in an exception handler without changing the previous value. A reset or a restore operation of the null state clears the FPIAR.



6.2 FLOATING-POINT DATA FORMATS AND DATA TYPES

The M68000 floating-point model (MC68881, MC68882, MC68040, and MC68060) supports the following floating-point data formats: single precision, double precision, extended precision, and packed decimal. The M68000 floating-point model supports the following data types: normalized, zeros, infinities, unnormalized numbers, denormalized numbers, and NaNs. The MC68060 supports part of the M68000 floating-point model in hardware. Table 6-3 lists the floating-point data formats and data types supported by the MC68060. Table 6-4 through Table 6-7 summarize the floating-point data formats and data types details.

Table 6-3. MC68060 FPU Data Formats and Data Types

Number Types	Data Formats						
	Single-Precision Real	Double-Precision Real	Extended-Precision Real	Packed-Decimal Real	Byte Integer	Word Integer	Long-Word Integer
Normalized	•	•	•	†	•	•	•
Zero	•	•	•	†	•	•	•
Infinity	•	•	•	†	—	—	—
NAN	•	•	•	†	—	—	—
Denormalized	†	†	†	†	—	—	—
Unnormalized	—	—	†	†	—	—	—

• Data Format/Type Supported by On-Chip MC68060 FPU Hardware

† Data Format/Type Supported by Software (M68060SP)

Table 6-4. Single-Precision Real Format Summary

Data Format	
$\begin{array}{ c c c c } \hline & 31 & 30 & \dots & 23 & 22 & & & & & 0 \\ \hline & s & & & e & & & & & & f \\ \hline \end{array}$	f
Field Size In Bits	
Sign (s)	1
Biased Exponent (e)	8
Fraction (f)	23
Total	32
Interpretation of Sign	
Positive Fraction	s = 0
Negative Fraction	s = 1
Normalized Numbers	
Bias of Biased Exponent	+127 (\$7F)
Range of Biased Exponent	$0 < e < 255$ (\$FF)
Range of Fraction	Zero or Nonzero
Fraction	1.f
Relation to Representation of Real Numbers	$(-1)^s \times 2^{e-127} \times 1.f$
Denormalized Numbers	
Biased Exponent Format Minimum	0 (\$00)
Bias of Biased Exponent	+126 (\$7E)
Range of Fraction	Nonzero
Fraction	0.f
Relation to Representation of Real Numbers	$(-1)^s \times 2^{-126} \times 0.f$
Signed Zeros	
Biased Exponent Format Minimum	0 (\$00)
Fraction	0.f = 0.0
Signed Infinities	
Biased Exponent Format Maximum	255 (\$FF)
Fraction	0.f = 0.0
NaNs	
Sign	Don't Care
Biased Exponent Format Maximum	255 (\$FF)
Fraction	Nonzero
Representation of Fraction	Nonsignaling Signaling Nonzero Bit Pattern Created by User Fraction When Created by FPU
	1xxxx...xxxx 0xxxx...xxxx xxxxx...xxxx 11111...1111
Approximate Ranges	
Maximum Positive Normalized	3.4×10^{38}
Minimum Positive Normalized	1.2×10^{-38}
Minimum Positive Denormalized	1.4×10^{-45}

Table 6-6. Extended-Precision Real Format Summary

Data Format	
<div style="text-align: center;"> 95 94 80 79 64 63 62 0 </div> <div style="text-align: center;"> s e u i f </div>	
Field Size (in Bits)	
Sign (s)	1
Biased Exponent (e)	15
Zero, Reserved (u)	16
Explicit Integer Bit (i)	1
Mantissa (f)	63
Total	96
Interpretation of Unused Bits	
Input	Don't Care
Output	All Zeros
Interpretation of Sign	
Positive Mantissa	s = 0
Negative Mantissa	s = 1
Normalized Numbers	
Bias of Biased Exponent	+16383 (\$3FFF)
Range of Biased Exponent	0 < e < 32767 (\$7FFF)
Explicit Integer Bit	1
Range of Mantissa	Zero or Nonzero
Mantissa (Explicit Integer Bit and Fraction)	1.f
Relation to Representation of Real Numbers	$(-1)^s \times 2^{e-16383} \times 1.f$
Denormalized Numbers	
Biased Exponent Format Minimum	0 (\$0000)
Bias of Biased Exponent	+16383 (\$3FFF)
Explicit Integer Bit	0
Range of Mantissa	Nonzero
Mantissa (Explicit Integer Bit and Fraction)	0.f
Relation to Representation of Real Numbers	$(-1)^s \times 2^{e-16383} \times 0.f$
Signed Zeros	
Biased Exponent Format Minimum	0 (\$0000)
Mantissa (Explicit Integer Bit and Fraction)	0.0
Signed Infinities	
Biased Exponent Format Maximum	32767 (\$7FFF)
Explicit Integer Bit	Don't Care
Mantissa (Explicit Integer Bit and Fraction)	x.000...0000
NaNs	
Sign	Don't Care
Explicit Integer Bit	Don't Care
Biased Exponent Format Maximum	32767 (\$7FFF)
Mantissa	Nonzero
Representation of Mantissa	
Nonsignaling	x.1xxxx...xxxx
Signaling	x.0xxxx...xxxx
Nonzero Bit Pattern Created by User	x.xxxxx...xxxx
Mantissa When Created by FPU	1.11111...1111

Table 6-6. Extended-Precision Real Format Summary (Continued)

Approximate Ranges	
Maximum Positive Normalized	1.2×10^{4932}
Minimum Positive Normalized	1.7×10^{-4932}
Minimum Positive Denormalized	1.7×10^{-4951}

Table 6-7. Packed Decimal Real Format Summary

95										64									
SM	SE	Y	Y	EXP2	EXP1	EXP0	(EXP3)	X	X	X	X	X	X	X	X	X	X	INTEGER	
63										32									
FRAC15	FRAC14	FRAC13	FRAC12	FRAC11	FRAC10	FRAC9	FRAC8	FRAC7	FRAC6	FRAC5	FRAC4	FRAC3	FRAC2	FRAC1	FRAC0				
31										0									
FRAC7	FRAC6	FRAC5	FRAC4	FRAC3	FRAC2	FRAC1	FRAC0												

Data Type	SM	SE	Y	Y	3-Digit Exponent	1-Digit Integer	16-Digit Fraction
!Infinity	0/1	1	1	1	\$FFF	\$XXXX	\$00...00
±NAN	0/1	1	1	1	\$FFF	\$XXXX	Nonzero
±SNAN	0/1	1	1	1	\$FFF	\$XXXX	Nonzero
+Zero	0	0/1	X	X	\$000-\$999	\$XXX0	\$00...00
-Zero	1	0/1	X	X	\$000-\$999	\$XXX0	\$00...00
+In-Range	0	0/1	X	X	\$000-\$999	\$XXX0-\$XXX9	\$00...01-\$99...99
-In-Range	1	0/1	X	X	\$000-\$999	\$XXX0-\$XXX9	\$00...01-\$99...99

NOTE: EXP3 is generated only during an FMOVE OUT if the source is too large to be represented with a three-digit exponent. Otherwise, it is a don't care.

6.3 COMPUTATIONAL ACCURACY

Whenever an attempt is made to represent a real number in a binary format of finite precision, there is a possibility that the number can not be represented exactly. This is commonly referred to as a round-off error. Furthermore, when two inexact numbers are used in a calculation, the error present in each number is reflected, and possibly aggravated, in the result. All FPU calculations use an intermediate result. When the MC68060 performs an operation, the calculation is carried out using extended-precision inputs, and the intermediate result is calculated as if to produce infinite precision. After the calculation is complete, the intermediate result is rounded to the selected precision and stored in the destination.

The FPCR RND and PREC encodings (see Table 6-1 and Table 6-2) provide emulation for devices that only support single and double precision. By setting the rounding precision to single, the MC68060 will perform all calculations as if only 24 bits of precision were available for the result. Setting the rounding precision to double does the same to 53 bits of precision. The execution speed of all instructions is the same whether using single- or double-precision rounding. When using these two forced rounding precisions, the MC68060 produces the same results as any other device that conforms to the IEEE 754 standard, but does not support extended precision. The results are the same when performing the same operation in extended precision and storing the results in single- or double-precision format.

Floating-Point Unit

The FPU performs all floating-point internal operations in extended precision. It supports mixed-mode arithmetic by converting single- and double-precision operands to extended-precision values before performing the specified operation. The FPU converts all memory data formats to extended precision before using it in a floating-point operation or loading it in a floating-point data register. The FPU also converts extended-precision data formats in a floating-point data register to any data format and either stores it in a memory destination or in an integer data register.

If the external operand is a denormalized number or unnormalized number, the number is normalized before an operation is performed. However, an external denormalized number moved into a floating-point data register is stored as a denormalized number.

If an external operand is an unnormalized number, the number is normalized before it is used in an arithmetic operation. If the external operand is an unnormalized zero (i.e., with a mantissa of all zeros), the number is converted to a normalized zero before the specified operation is performed. The regular use of unnormalized inputs not only defeats the purpose of the IEEE 754 standard, but also can produce gross inaccuracies in the results.

6.3.1 Intermediate Result

Figure 6-8 illustrates the intermediate result format. The intermediate result's exponent for some dyadic operations (e.g., multiply and divide) can easily overflow or underflow the 15-bit exponent of the destination floating-point register. To simplify the overflow and underflow detection, intermediate results in the FPU maintain a 16-bit, two's-complement integer exponent. Detection of an overflow or underflow intermediate result always converts the 16-bit exponent into a 15-bit biased exponent before being stored in a floating-point data register. The FPU internally maintains the 67-bit mantissa for rounding purposes. The mantissa is always rounded to 64 bits (or less, depending on the selected rounding precision) before it is stored in a floating-point data register.

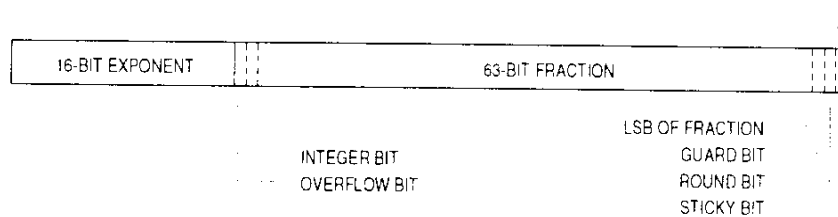

Figure 6-8. Intermediate Result Format

If the destination is a floating-point data register, the result is in the extended-precision format and is rounded to the precision specified by the FPCR PREC bits before being stored. All mantissa bits beyond the selected precision are zero. If the single- or double-precision mode is selected, the exponent value is in the correct range even if it is stored in extended-precision format. If the destination is a memory location, the FPCR PREC bits are ignored. In this case, a number in the extended-precision format is taken from the source floating-point data register, rounded to the destination format precision, and then written to memory.

Depending on the selected rounding mode or destination data format in effect, the location of the least significant bit of the mantissa and the locations of the guard, round, and sticky bits in the 67-bit intermediate result mantissa varies. The guard and round bits are always calculated exactly. The sticky bit is used to create the illusion of an infinitely wide intermediate result. As the arrow illustrates in Figure 6-8, the sticky bit is the logical OR of all the bits in the infinitely precise result to the right of the round bit. During the calculation stage of an arithmetic operation, any nonzero bits generated that are to the right of the round bit set the sticky bit to one. Because of the sticky bit, the rounded intermediate result for all required IEEE arithmetic operations in the RN mode is in error by no more than one-half unit in the last place.

6.3.2 Rounding the Result

Range control is the process of rounding the mantissa of the intermediate result to the specified precision and checking the 16-bit intermediate exponent to ensure that it is within the representable range of the selected rounding-precision format. Range control ensures correct emulation of a device that only supports single- or double-precision arithmetic. If the intermediate result's exponent exceeds the range of the selected precision, the exponent value appropriate for an underflow or overflow is stored as the result in the 16-bit extended-precision format exponent. For example, if the data format and rounding mode is single-precision RM and the result of an arithmetic operation overflows the magnitude of the single-precision format, the largest normalized single-precision value is stored as an extended-precision number in the destination floating-point data register (i.e., an unbiased 15-bit exponent of \$00FF and a mantissa of \$FFFFFF0000000000). If an infinity is the appropriate result for an underflow or overflow, the infinity value for the destination data format is stored as the result (i.e., an exponent with the maximum value and a mantissa of zero).

6

Figure 6-9 illustrates the algorithm that is used to round an intermediate result to the selected rounding precision and destination data format. If the destination is a floating-point data register, either the selected rounding precision specified by the FPCR PREC bits or by the instruction itself determines the rounding boundary. For example, FSADD and FDADD specify single- and double-precision rounding regardless of the precision specified in the FPCR PREC bits. If the destination is external memory or an integer data register, the destination data format determines the rounding boundary. If the rounded result of an operation is not exact, then the INEX2 bit is set in the FPSR EXC byte.

The three additional bits beyond the extended-precision format allow the FPU to perform all calculations as though it were performing calculations using a float engine with infinite bit precision. The result is always correct for the specified destination's data format before performing rounding (unless an overflow or underflow error occurs). The specified rounding operation then produces a number that is as close as possible to the infinitely precise intermediate value and still representable in the selected precision. The following tie-case example illustrates how the 67-bit mantissa allows the FPU to meet the error bound of the IEEE specification:

The least significant bit of the rounded result does not increment even though the guard bit is set in the intermediate result. The IEEE 754 standard specifies that tie cases should be

Floating-Point Unit

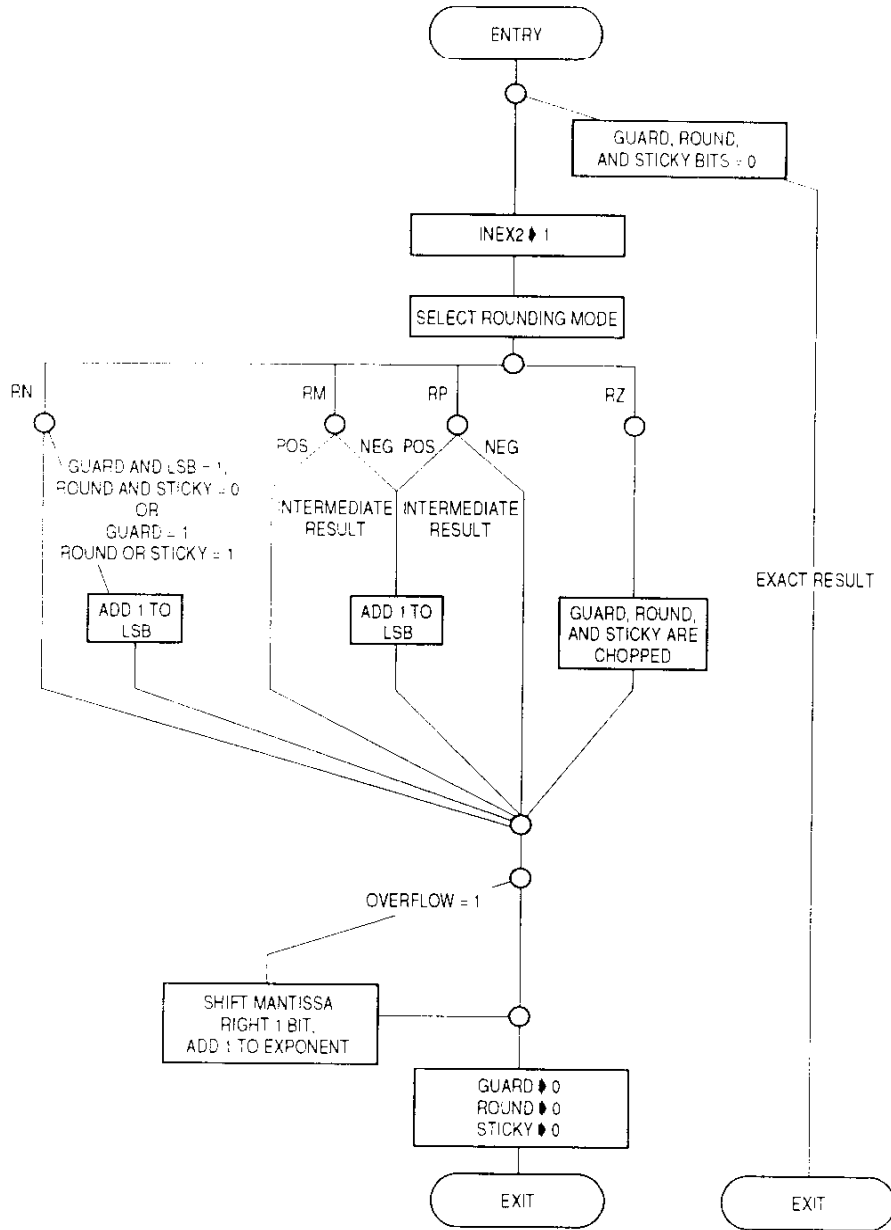

Figure 6-9. Rounding Algorithm Flowchart

Result	Integer	63-Bit Fraction	Guard	Round	Sticky
Intermediate	x	xxx...x00	1	0	0
Rounded-to-Nearest	x	xxx...x00	0	0	0

handled in this manner. If the destination data format is extended and there is a difference between the infinitely precise intermediate result and the round-to-nearest result, the relative difference is 2^{-64} (the value of the guard bit). This error is equal to one-half of the least significant bit's value and is the worst case error that can be introduced when using the RN

mode. Thus, the term one-half unit in the last place correctly identifies the error bound for this operation. This error specification is the relative error present in the result; the absolute error bound is equal to $2^{\text{exponent}} \times 2^{-64}$. The following example illustrates the error bound for the other rounding modes:

Result	Integer	63-Bit Fraction	Guard	Round	Sticky
Intermediate	x	xxx...x00	1	1	1
Rounded-to-Zero	x	xxx...x00	0	0	0

The difference between the infinitely precise result and the rounded result is $2^{-64} + 2^{-65} + 2^{-66}$, which is slightly less than 2^{-63} (the value of the least significant bit). Thus, the error bound for this operation is not more than one unit in the last place. For all arithmetic operations, the FPU meets these error bounds, providing accurate and repeatable results.

6.4 POSTPROCESSING OPERATION

6

Most operations end with a postprocessing step. The FPU provides two steps in postprocessing. First, the condition code bits in the FPSR are set or cleared at the end of each arithmetic operation or move operation to a single floating-point data register. The condition code bits are consistently set based on the result of the operation. Second, the FPU supports 32 conditional tests that allow floating-point conditional instructions to test floating-point conditions in exactly the same way as the integer conditional instructions test the integer condition codes. The combination of consistently set condition code bits and the simple programming of conditional instructions gives the MC68060 a very flexible, high-performance method of altering program flow based on floating-point results. While reading the summary for each instruction, it should be assumed that an instruction performs postprocessing unless the summary specifically states that the instruction does not do so. The following paragraphs describe postprocessing in detail.

6.4.1 Underflow, Round, and Overflow

During the calculation of an arithmetic result, the FPU arithmetic logic unit (ALU) has more precision and range than the 80-bit extended-precision format. However, the final result of these operations is an extended-precision floating-point value. In some cases, an intermediate result becomes either smaller or larger than can be represented in extended precision. Also, the operation can generate a larger exponent or more bits of precision than can be represented in the chosen rounding precision. For these reasons, every arithmetic instruction ends by rounding the result and checking for overflow and underflow.

At the completion of an arithmetic operation, the intermediate result is checked to see if it is too small to be represented as a normalized number in the selected precision. If so, the UNFL bit is set in the FPSR EXC byte. The MC68060 then takes a nonmaskable underflow exception and executes the M68060SP underflow exception handler, denormalizing the result. Denormalizing a number causes a loss of accuracy, but a zero is not returned unless a gross underflow occurs. If a number has grossly underflowed, the MC68060 takes a nonmaskable underflow exception, and the M68060SP returns a zero or the smallest denormalized number with the correct sign, depending on the rounding mode in effect.

Floating-Point Unit

If no underflow occurs, the intermediate result is rounded according to the user-selected rounding precision and rounding mode. After rounding, the INEX2 bit of the FPSR EXC byte is set accordingly. Finally, the magnitude of the result is checked to see if it is too large to be represented in the current rounding precision. If so, the OVFL bit of the FPSR EXC byte is set, and the MC68060 takes a nonmaskable overflow exception and executes the M68060SP overflow exception handler. The M68060SP returns a correctly signed infinity or a correctly signed largest normalized number, depending on the rounding mode in effect.

6.4.2 Conditional Testing

Unlike the integer arithmetic condition codes, an instruction either always sets the floating-point condition codes in the same way or it does not change them at all. Therefore, the instruction descriptions do not include floating-point condition code settings. The following paragraphs describe how floating-point condition codes are set for all instructions that modify condition codes. Refer to **6.1.3.1 Floating-Point Condition Code Byte** for a description of the FPCC byte.

The data type of the operation's result determines how the four condition code bits are set. Table 6-8 lists the condition code bit setting for each data type. The MC68060 generates only eight of the 16 possible combinations. Loading the FPCC with one of the other combinations and executing a conditional instruction can produce an unexpected branch condition.

Table 6-8. Floating-Point Condition Code Encoding

Data Type	N	Z	I	NAN
+ Normalized or Denormalized	0	0	0	0
- Normalized or Denormalized	1	0	0	0
+ 0	0	1	0	0
- 0	1	1	0	0
+ Infinity	0	0	1	0
- Infinity	1	0	1	0
+ NAN	0	0	0	1
- NAN	1	0	0	1

The inclusion of the NAN data type in the IEEE floating-point number system requires each conditional test to include the NAN condition code bit in its Boolean equation. Because a comparison of a NAN with any other data type is unordered (i.e., it is impossible to determine if a NAN is bigger or smaller than an in-range number), the compare instruction sets the NAN condition code bit when an unordered compare is attempted. All arithmetic instructions also set the FPCC NAN bit if the result of an operation is a NAN. The conditional instructions interpret the NAN condition code bit equal to one as the unordered condition.

The IEEE 754 standard defines four conditions: equal to (EQ), greater than (GT), less than (LT), and unordered (UN). In addition, the standard only requires the generation of the condition codes as a result of a floating-point compare operation. The FPU tests for these conditions and 28 others at the end of any operation affecting the condition codes. For purposes of the floating-point conditional branch, set byte on condition, decrement and branch on condition, and trap on condition instructions, the MC68060 logically combines the four FPCC bits to form 32 conditional tests. The 32 conditional tests are separated into two groups—16

tests that set the BSUN bit in the FPSR status byte if an unordered condition is present when the conditional test is attempted (IEEE nonaware tests), and 16 tests that do not cause the BSUN bit in the FPSR status byte (IEEE aware tests). The set of IEEE nonaware tests is best used:

- When porting a program from a system that does not support the IEEE 754 standard to a conforming system, or
- When generating high-level language code that does not support IEEE floating-point concepts (i.e., the unordered condition).

An unordered condition occurs when one or both of the operands in a floating-point compare operation is a NAN. The inclusion of the unordered condition in floating-point branches destroys the familiar trichotomy relationship (greater than, equal, less than) that exists for integers. For example, the opposite of floating-point branch greater than (FBGT) is not floating-point branch less than or equal (FBLE). Rather, the opposite condition is floating-point branch not greater than (FBNGT). If the result of the previous instruction was unordered, FBNGT is true; whereas, both FBGT and FBLE would be false since unordered fails both of these tests. Compiler programmers should be particularly careful of the lack of trichotomy in the floating-point branches since it is common for compilers to invert the sense of conditions.

When using the IEEE nonaware tests, the BSUN bit and the NAN bit are set in the FPSR, unless the branch is an FBEQ or an FBNE. If the BSUN exception is enabled in the FPCR, an exception is taken. Therefore, the IEEE nonaware program may be interrupted if an unexpected condition occurs.

Compilers and programmers who are knowledgeable of the IEEE 754 standard should use the IEEE aware tests in programs that contain ordered and unordered conditions. Since the ordered or unordered attribute is explicitly included in the conditional test, the BSUN bit is not set in the FPSR EXC byte when the unordered condition occurs.

Table 6-9 summarizes the conditional mnemonics, definitions, equations, predicates, and whether the BSUN bit is set in the FPSR EXC byte for the 32 floating-point conditional tests. The equation column lists the combination of FPCC bits for each test in the form of an equation.

Floating-Point Unit

Table 6-9. Floating-Point Conditional Tests

Mnemonic	Definition	Equation	Predicate	BSUN Bit Set
IEEE Nonaware Tests				
EQ	Equal	Z	000001	No
NE	Not Equal	Z	001110	No
GT	Greater Than	$\overline{NAN} + Z + N$	010010	Yes
NGT	Not Greater Than	$\overline{NAN} + Z + N$	011101	Yes
GE	Greater Than or Equal	$Z + (\overline{NAN} + \overline{N})$	010011	Yes
NGE	Not Greater Than or Equal	$\overline{NAN} + (N \cdot Z)$	011100	Yes
LT	Less Than	$N \cdot (\overline{NAN} + Z)$	010100	Yes
NI T	Not Less Than	$\overline{NAN} + (\overline{Z} + \overline{N})$	011011	Yes
LE	Less Than or Equal	$Z + (N \cdot \overline{NAN})$	010101	Yes
NLE	Not Less Than or Equal	$\overline{NAN} + (\overline{N} + Z)$	011010	Yes
GL	Greater or Less Than	$\overline{NAN} + Z$	010110	Yes
NGL	Not Greater or Less Than	$\overline{NAN} + Z$	011001	Yes
GLE	Greater, Less, or Equal	\overline{NAN}	010111	Yes
NGLE	Not Greater, Less, or Equal	\overline{NAN}	011000	Yes
IEEE Aware Tests				
EQ	Equal	Z	000001	No
NE	Not Equal	Z	001110	No
OGT	Ordered Greater Than	$\overline{NAN} + Z + N$	000010	No
ULE	Unordered or Less or Equal	$\overline{NAN} + Z + N$	001101	No
OGE	Ordered Greater Than or Equal	$Z + (\overline{NAN} + \overline{N})$	000011	No
ULT	Unordered or Less Than	$\overline{NAN} + (N \cdot Z)$	001100	No
OLT	Ordered Less Than	$N \cdot (\overline{NAN} + Z)$	000100	No
UGE	Unordered or Greater or Equal	$\overline{NAN} + (Z + \overline{N})$	001011	No
OLE	Ordered Less Than or Equal	$Z + (N \cdot \overline{NAN})$	000101	No
UGT	Unordered or Greater Than	$\overline{NAN} + (\overline{N} + Z)$	001010	No
OGL	Ordered Greater or Less Than	$\overline{NAN} + Z$	000110	No
UEQ	Unordered or Equal	$\overline{NAN} + Z$	001001	No
OR	Ordered	\overline{NAN}	000111	No
UN	Unordered	\overline{NAN}	001000	No
Miscellaneous Tests				
F	False	False	000000	No
T	True	True	001111	No
SF	Signaling False	False	010000	Yes
ST	Signaling True	True	011111	Yes
SEQ	Signaling Equal	Z	010001	Yes
SNE	Signaling Not Equal	Z	011110	Yes

NOTE: All condition codes with an overbar indicate cleared bits; all other bits are set.

6.5 FLOATING-POINT EXCEPTIONS

There are two classes of floating-point-related exceptions: nonarithmetic floating point exceptions and arithmetic floating-point exceptions. The latter relates to the handling of arithmetic exceptions caused by floating-point activity, and the former includes unimplemented floating-point instructions, unsupported data types and unimplemented effective addresses not related to the handling of arithmetic exceptions. The floating-point format error exception is considered an integer unit exception (see **Section 8 Exception Processing**). The following paragraphs detail floating-point exceptions and how the MC68060 and M68060SP handle them. Table 6-10 lists the vector numbers related to floating-point exceptions.

Table 6-10. Floating-Point Exception Vectors

Vector Number	Vector Offset (Hex)	Frame Format	Program Counter	Assignment
11 55 60	02C 0DC 0F4	2 0,2,3 0	next next fault	Floating-Point Unimplemented Instruction Exception Floating-Point Unimplemented Data Type Unimplemented Effective Address Exception
48 49 50 51 52 53 54	0C0 0C4 0C8 0CC 0D0 0D4 0D8	0 0,3 0 0,3 0,3 0,3 0,3	fault next next next next next next	Floating-Point Branch or Set on Unordered Condition Floating-Point Inexact Result Floating-Point Divide-by-Zero Floating-Point Underflow Floating-Point Operand Error Floating-Point Overflow Floating-Point SNAN

For floating-point pre-instruction exceptions, the PC points to the next floating-point instruction and the stack frame of format 0 is generated. For post-instruction exceptions, the PC points to the next instruction and the frame of format 3 is generated.

The following paragraphs detail nonarithmetic floating-point exceptions.

6.5.1 Unimplemented Floating-Point Instructions

Table 6-11 lists the floating-point instructions which are unimplemented on the MC68060. Refer to **8.2.4 Illegal Instruction and Unimplemented Instruction Exceptions** for background material. Motorola provides the M68060SP, a software package that includes floating-point emulation for the MC68060. Refer to Appendix C for software porting information.



Table 6-11. Unimplemented Instructions

Monadic Operations	
FACOS	FLOGN
FASIN	FLOGNP1
FATAN	FMOVECR
FATANH	FSIN
FCOS	FSINCOS
FCOSH	FSINH
FETOX	FTAN
FETOXM1	FTANH
FGETEXP	FTENTOX
FGETMAN	FTWOTOX
FLOG10	FLOG2
Dyadic Operations	
FMOD	FREM
FSCALE	—
Miscellaneous	
FTRAPcc	FDBcc
FSc	—
Unimplemented Effective Address	
FMOVEM.X (dynamic register list)	FMOVEM.L #immediate, list of 2 or 3 control registers
F<op>.X #immediate,FPn	F<op>.P #immediate,FPn

A floating-point unimplemented instruction exception occurs when the processor attempts to execute an instruction word pattern that begins with \$F, the processor recognizes this bit pattern as an MC68881 instruction, the FPU is enabled via the processor control register (PCR), but the floating-point instruction is not implemented in the MC68060 FPU. This exception corresponds to vector number 11 and shares this vector with the floating-point disabled and the unimplemented F-line exceptions. A stack frame of type 2 is generated when this exception is reported. The stacked PC points to the logical address of the next instruction after the floating-point instruction. In addition, the effective address of the floating-point operand in memory (if any) is calculated and stored in the effective address field.

When an unimplemented floating-point instruction is encountered, the processor waits for all previous floating-point instructions to complete execution. Pending exceptions are taken and handled prior to the execution of the unimplemented instruction.

The processor begins exception processing for the unimplemented floating-point instruction by making an internal copy of the current status register (SR). The processor then enters the supervisor mode and clears the trace bit. The processor creates a format \$2 stack frame and saves the vector offset, PC, internal copy of the SR, and calculated effective address in the stack frame. The saved PC value is the logical address of the instruction that follows the unimplemented floating-point instruction. The processor generates exception vector number 11 for the unimplemented F-line instruction exception vector, fetches the address of the F-line exception handler from the processor's exception vector table, pushes the format \$2 stack frame on the system stack, and begins execution of the exception handler after prefetching instructions to fill the pipeline.

The M68060SP emulates the unimplemented floating-point instruction in software, maintaining user-object-code compatibility. Refer to **Section 8 Exception Processing** for details about exception vectors and format \$2 stack frames.

The M68060SP uses the FPIAR to determine the instruction needing emulation and uses the effective address field to fetch the memory operand, if any. Once the instruction has been emulated and the result is reached, the M68060SP moves the result into the appropriate destination floating-point data register or memory location and returns to normal instruction flow using the RTE instruction.

The M68060SP not only emulates the instruction, but in addition, it ensures that if any floating-point arithmetic exceptional conditions arise from the emulation of the unimplemented instruction and if the corresponding floating-point arithmetic exception is enabled, the M68060SP restores the floating-point state frame back into the FPU in the desired exceptional state. This effectively imitates the action of the MC68060-implemented instructions.

6

6.5.2 Unsupported Floating-Point Data Types

An unsupported data type exception occurs when either operand to an implemented floating-point instruction is denormalized (for single-, double-, and extended-precision operands), unnormalized (for extended-precision operands), or either the source or destination data format is packed decimal real. These data types are unimplemented in the MC68060 and must be emulated in software.

NOTE

In this manual, all references to the unsupported floating-point data types also refer to the unimplemented data types.

When the processor encounters an unsupported data type, the procedure taken is identical to that used when an unimplemented instruction is taken. Unsupported data types with operands for register-to-register or memory-to-register instructions cause a pre-instruction exception. When an unsupported data type is detected for an FMOVE OUT instruction, a post-instruction exception is generated immediately. A format \$0 (for the pre-instruction exception caused by unnormalized or denormalized operands), format \$3 (for the post-instruction exception caused by unnormalized or denormalized operands), or format \$2 (caused by packed decimal real) stack frame is saved, and vector number 55 is fetched. Note that a denormalized value generated as the result of a floating-point operation generates a nonmaskable underflow exception instead of an unsupported data type exception.

Figure 6-10 lists the floating-point state frame fields for unsupported data type exceptions.

The M68060SP uses the FPIAR to determine the instruction that caused the exception. The effective address field of the stack frame format \$2 points to the offending source operand in memory (if any). The effective address field of the stack frame format \$3 points to the destination operand in memory (if any). The M68060SP provides the routines needed to complete the instruction and stores the result to the proper destination, whether it be in a floating-point data register, integer data register, or external memory. Once the destination is written,

Floating-Point Unit

the floating-point state frame is discarded, and normal execution is resumed by using the RTE instruction.

The M68060SP not only emulates the instruction, but in addition, it ensures that if any floating-point arithmetic exceptional conditions arise from the instruction emulation with the unsupported data type instruction and if the corresponding floating-point arithmetic exception is enabled, the M68060SP restores the floating-point state frame back into the FPU in the desired exceptional state. This effectively imitates the action of the MC68060-implemented instructions.

6.5.3 Unimplemented Effective Address Exception

The unimplemented effective address exception corresponds to vector number 60, and occurs when the processor attempts to execute a floating-point instruction that contains an extended-precision or packed BCD immediate operand, or when the processor attempts to execute an FMOVE.M.L instruction with an immediate addressing mode to more than one floating-point control register (FPCR, FPSR, FPIAR), or when the processor attempts an FMOVE.M.X instruction using a dynamic register list. The stack frame of type \$0 is generated when this exception is reported. The stacked PC points to the logical address of the instruction that caused the exception.

The M68060SP uses the stacked PC to point to the instruction that needs to be emulated. The M68060SP emulates the instruction, increments the stacked PC and returns to the normal program flow.

The M68060SP not only emulates the instruction, but in addition, it ensures that if any floating-point arithmetic exceptional conditions arise from the instruction emulation including the unimplemented effective address and if the corresponding floating-point arithmetic exception is enabled, the M68060SP restores the floating-point state frame back into the FPU in the desired exceptional state. This effectively imitates the action of the MC68060 implemented instructions.

6.6 FLOATING-POINT ARITHMETIC EXCEPTIONS

The MC68060, with the aid of the M68060SP, provides the full MC68881 instruction set, effective address, data type, and exception handling compatibility. From the perspective of the user-supplied exception handlers, the information provided by the MC68060 or the MC68060/M68060SP combination are consistent in that no distinction needs to be made by the user handler between native MC68060 instructions and non-native instructions or data types. This section discusses the operation of the MC68060, with the aid of the M68060SP, and how information is perceived and used by the user-supplied exception handler. It is assumed in this section that the M68060SP is already ported properly to the MC68060 system.

The following eight user floating-point arithmetic exceptions are listed in order of priority.

- Branch/Set on Unordered (BSUN)
- Signaling Not-A-Number (SNAN)
- Operand Error (OPERR)
- Overflow (OVFL)
- Underflow (UNFL)
- Divide-by-Zero (DZ)
- Inexact 2 (INEX2)
- Inexact 1 (INEX1)

INEX1 exception is the condition that exists when a packed decimal operand cannot be converted exactly to the extended-precision format in the current rounding mode. Since the MC68060 does not directly support packed decimal real operands, the processor never sets INEX1 bit in the FPSR EXC byte, but provides it as a latch so that the M68060SP (emulation software) can report the exception.

6

The processor takes a floating-point arithmetic exception in one of two situations. The first situation occurs when the user program enables an arithmetic exception by setting a bit in the FPCR ENABLE byte and the corresponding bit in the FPSR EXC byte matches the bit in the FPCR ENABLE byte as a result of program execution. This is referred to as a maskable exception condition since it is possible to prevent an exception from occurring. All exceptions except the OVFL and UNFL are maskable. For the SNAN, OPERR, DZ, and INEX enabled exception cases, some assistance from the M68060SP is required to provide MC68881-compatible operation. Therefore, the M68060SP supervisor exception handler is executed before handing control over to the user-supplied exception handler.

Note that a user write operation to the FPSR, which sets a bit in the EXC byte, does not cause an exception to be taken, regardless of the value in the ENABLE byte. When a user writes to the ENABLE byte that enables a class of floating-point exceptions, a previously generated floating-point exception does not cause an exception to be taken, regardless of the value in the FPSR EXC byte. The user can clear a bit in the FPCR ENABLE byte, disabling each corresponding exception.

The second situation that will cause the processor to take a floating-point arithmetic exception occurs when the processor encounters an OVFL or UNFL condition. These exceptional conditions are non-maskable, requiring the M68060SP to correct a defaulting result generated by the MC68060 that is different from the result generated by an MC68881/MC68882 executing the same code. After correcting the result, the M68060SP exception handler hands control over to a user-defined exception handler if the exception has been enabled in the FPCR ENABLE byte or returns to the main program flow if the exception is disabled.

As outlined in **6.5.1 Unimplemented Floating-Point Instructions** to **6.5.3 Unimplemented Effective Address Exception**, there are certain conditions such that the M68060SP reports floating-point arithmetic exceptions as part of handling an unimplemented floating-point instruction, unimplemented effective address, or unsupported data

Floating-Point Unit

type exception. The M68060SP passes control over to the user-supplied exception handler, if needed.

A single instruction execution can generate multiple exceptions. When multiple exceptions occur with exceptions enabled for more than one exception class, the highest priority exception is reported; the lower priority exceptions are never reported or taken. The previous list of arithmetic floating-point exceptions is in order of priority. The bits of the ENABLE byte are organized in decreasing priority, with bit 15 being the highest and bit 8 the lowest. The exception handler must check for multiple exceptions. The address of the exception handler is derived from the vector number corresponding to the exception. The following is a list of multiple instruction exceptions that can occur:

- SNAN and INEX1
- OPERR and INEX2
- OPERR and INEX1
- OVFL and INEX2 and/or INEX1
- UNFL and INEX2 and/or INEX1
- INEX2 and INEX1

6.6.1 Branch/Set on Unordered (BSUN)

The BSUN exception is the result of performing an IEEE nonaware conditional test associated with the FBcc, FDBcc, FTRAPcc, and FScc instructions when an unordered condition is present. Refer to **6.4.2 Conditional Testing** for information on conditional tests.

If a floating-point exception is pending from a previous floating-point instruction, a pre-instruction exception is taken to handle that exception. After the appropriate exception handler is executed, the conditional instruction is restarted. When the previous floating-point instruction has completed including related exception handling, the conditional predicate is evaluated and checked for a BSUN exception before executing the conditional instruction. A BSUN exception is generated in hardware through the FBcc instruction only. All other BSUN-generating instructions (FDBcc, FTRAPcc, and FScc) are emulated via the M68060SP. No M68060SP BSUN handler is provided since the processor already provides MC68881-compatible operation when reporting a BSUN exception.

A BSUN exception occurs if the conditional predicate is one of the IEEE nonaware branches and the FPCC NAN bit is set. When this condition is detected, the BSUN bit in the FPSR EXC byte is set.

6.6.1.1 TRAP DISABLED RESULTS (FPCR BSUN BIT CLEARED). The floating-point condition is evaluated as if it were the equivalent IEEE aware conditional predicate. No exceptions are taken.

6.6.1.2 TRAP ENABLED RESULTS (FPCR BSUN BIT SET). The processor takes a floating-point pre-instruction exception. A \$0 stack frame is saved, and vector number 48 is generated to access the BSUN exception vector. The BSUN entry in the processor's vector table points to the user BSUN exception handler.

The user BSUN exception handler must execute an FSAVE as its first floating-point instruction. FSAVE allows other floating-point instructions to execute without reporting the BSUN exception again, although none of the state frame values are useful in the execution of the user BSUN exception handler. The BSUN exception is unique in that the exception is taken before the conditional predicate is evaluated. If the user BSUN exception handler does not set the PC to the instruction following the one that caused BSUN exception when returning, the exception is executed again. Therefore, it is the responsibility of the user BSUN exception handler to prevent the conditional instruction from taking the BSUN exception again. There are four ways to prevent taking the exception again:

1. Incrementing the stored PC in the stack bypasses the conditional instruction. This technique applies to situations where a fall-through is desired. Note that accurate calculation of the PC increment requires detailed knowledge of the size of the conditional instruction being bypassed.
2. Clearing the NAN bit prevents the exception from being taken again. However, this alone cannot deterministically control the result's indication (true or false) that would be returned when the conditional instruction re-executes.
3. Disabling the BSUN bit also prevents the exception from being taken again. Like the second method, this method cannot control the result indication (true or false) that would be returned when the conditional instruction re-executes.
4. Examining the conditional predicate and setting the FPCC NAN bit accordingly prevents the exception from being taken again. This technique gives the most control since it is possible to predetermine the direction of program flow. Bit 7 of the F-line operation word indicates where the conditional predicate is located. If bit 7 is set, the conditional predicate is the lower six bits of the F-line operation word. Otherwise, the conditional predicate is the lower six bits of the instruction word, which immediately follows the F-line operation word. Using the conditional predicate and the table for IEEE nonaware test in **6.4.2 Conditional Testing**, the condition codes can be set to return a known result indication when the conditional instruction is re-executed.

Prior to exiting the user BSUN exception handler, the user exception handler discards the floating-point state frame before executing the RTE to return to normal program flow.

6.6.2 Signaling Not-a-Number (SNAN)

An SNAN is used as an escape mechanism for a user-defined, non-IEEE data type. The processor never creates an SNAN as a result of an operation; a NAN created by an operand error exception is always a non-signaling NAN. When an operand is an SNAN involved in an arithmetic instruction, the SNAN bit is set in the FPSR EXC byte. Since the FMOVE, FMOVE FPCR, and FSAVE instructions do not modify the status bits, they cannot generate exceptions. Therefore, these instructions are useful for manipulating SNANs.

6.6.2.1 TRAP DISABLED RESULTS (FPCR SNAN BIT CLEARED). If the destination data format is S, D, X, or P, then the most significant bit of the fraction is set to one and the resulting non-signaling NAN is transferred to the destination. No bits other than the SNAN bit of the NAN are modified, although the input NAN is truncated if necessary. If the destination data format is B, W, or L, then the 8, 16, or 32 most significant bits of the SNAN significand, with the SNAN bit set, are written to the destination.

Floating-Point Unit

6.6.2.2 TRAP ENABLED RESULTS (FPCR SNAN BIT SET). If the destination is not a floating-point data register (FMOVE OUT instruction), the destination (memory or integer data register) is written with the same data as though the trap were disabled (FPCR SNAN bit clear), and then control is passed to the user SNAN handler as a post-instruction exception. If desired, the user SNAN handler can overwrite the result.

For floating-point data register destinations, the source (if register-to-register instruction) and destination floating-point data registers are not modified. Control is passed to the user SNAN handler as a pre-instruction exception when the next floating-point instruction is encountered. In this case, the SNAN user handler should supply the result.

The SNAN user handler must execute an FSAVE instruction as the first floating-point instruction to prevent the FPU from taking more exceptions. The FSAVE frame generates a floating-point frame that contains the source operand that has been converted to extended precision. If the destination is a floating-point data register, it contains the original value. The FPIAR points to the floating-point instruction that caused the exception. In addition, if the offending instruction is FMOVE OUT, an integer stack frame format \$3 is created as a result of a post-instruction exception, the effective address of the destination memory operand is provided. The effective address field is undefined if the destination is an integer data register.

The user SNAN exception handler may discard the floating-point state frame once the handler has completed. The RTE instruction must be executed to return to normal instruction flow.

6.6.3 Operand Error

The operand error exception encompasses problems arising in a variety of operations, including those errors not frequent or important enough to merit a specific exceptional condition. Basically, an operand error occurs when an operation has no mathematical interpretation for the given operands. Table 6-12 lists the possible operand errors, both native and non-native to the MC68060, which the M68060SP unimplemented instruction exception handler can report. When an operand error occurs, the OPERR bit is set in the FPSR EXC byte.

Table 6-12. Possible Operand Errors Exceptions

Instruction	Condition Causing Operand Error
Native to MC68060	
FADD	$[(+\infty) + (-\infty)]$ or $[(-\infty) + (+\infty)]$
FDIV	$(0 \div 0)$ or $(\infty \div \infty)$
FMOVE to B,W,or L	Integer overflow, source is nonsignaling NAN or $\pm\infty$
FMUL	One operand is 0 and other is $\pm\infty$
FSQRT	(Source < 0) or $(-\infty)$
FSUB	$[(+\infty) - (+\infty)]$ or $[(-\infty) - (-\infty)]$
Non-Native to MC68060	
FACOS	Source is $\pm\infty$, > +1, or < -1
FASIN	Source is $\pm\infty$, > +1, or < -1
FATANH	Source is $\pm\infty$, > +1, or < -1
FCOS	Source is $\pm\infty$
FGETEXP	Source is $\pm\infty$
FGETMAN	Source is $\pm\infty$
FLOG10	Source is < 0 or $-\infty$
FLOG2	Source is < 0 or $-\infty$
FLOGN	Source is < 0 or $-\infty$
FLOGNP1	Source is ≤ 1 or $-\infty$
FMOD	Floating-point data register is $\pm\infty$ or source is 0, other operand is not a NAN
FMOVE to P	Source exponent > 999 (decimal) or k-factor > 17
FREM	Floating-point data register is $\pm\infty$ or source is 0, other operand is not a NAN
FSCALE	Source is $\pm\infty$, other operand not a NAN
FSGLDIV	$(0 \div 0)$ or $(\infty \div \infty)$
FSGLMUL	One operand is 0, other operand is ∞
FSIN	Source is $\pm\infty$
FSINCOS	Source is $\pm\infty$
FTAN	Source is $\pm\infty$



6.6.3.1 TRAP DISABLED RESULTS (FPCR OPERR BIT CLEARED). For an FMOVE OUT instruction with the format S, D, or X, an OPERR is impossible. For an FMOVE OUT instruction with the format B, W, or L, an OPERR is possible only on an integer overflow, if the source is an infinity, or if the source is a NAN. On the integer overflow and infinity source cases, the largest positive or negative integer that can fit in the specified destination size (B, W, or L) is stored. On the NAN source case, the 8, 16, or 32 most significant bits of the NAN significand is stored in the B, W, or L destination.

For FMOVE OUT with the format P (packed decimal), if the k-factor is greater than +17, the result returned is a packed decimal string that assumes a k-factor equal to +17. For packed decimal results where the absolute value of the exponent is greater than 999, the decimal string is returned with the three least significant exponent digits in EXP2, EXP1, and EXP0. The fourth digit, EXP3, is supplied in the most significant four bits of the third byte in the string.

For all other OPERR cases, the destination is a floating-point data register. An extended-precision non-signaling NAN is stored in the destination.

6.6.3.2 TRAP ENABLED RESULTS (FPCR OPERR BIT SET). For the FMOVE OUT cases, the destination is written as if the trap were disabled, and then control is passed to

Floating-Point Unit

the user OPERR handler, as a post-instruction exception. If desired, the user OPERR handler can overwrite the default result.

If the destination is a floating-point data register, the register is not modified. Control is passed to the user OPERR handler as a pre-instruction exception when the next floating-point instruction is encountered. In this case, the user OPERR handler should generate the appropriate result.

The OPERR user handler must execute an FSAVE instruction as the first floating-point instruction to prevent the FPU from taking more exceptions. The FSAVE frame generates a floating-point frame that contains the source operand that has been converted to extended precision. If the destination is a floating-point data register, the register contains the original, unmodified value. The FPIAR points to the floating-point instruction that caused the exception. In addition, if the offending instruction is an FMOVE OUT, an integer stack frame format \$3 is created as a result of a post-instruction exception, the effective address of the destination memory operand is provided. The effective address field is undefined if the destination is an integer data register.

The user OPERR exception handler may discard the floating-point state frame once the handler has completed. The RTE instruction must be executed to return to normal instruction flow.

6.6.4 Overflow

An overflow exception is detected for arithmetic operations in which the destination is a floating-point data register or memory when the intermediate result's exponent is greater than or equal to the maximum exponent value of the selected rounding precision. Overflow can only occur when the destination is in the S-, D-, or X-precision format; all other data format overflows are handled as operand errors. At the end of any operation that could potentially overflow, the intermediate result is checked for underflow, rounded, and then checked for overflow before it is stored to the destination. If overflow occurs, the OVFL bit is set in the FPSR EXC byte.

Even if the intermediate result is small enough to be represented as an extended-precision number, an overflow can occur. The intermediate result is rounded to the selected precision, and the rounded result is stored in the extended-precision format. If the magnitude of the intermediate result exceeds the range of the selected rounding precision format, an overflow occurs.

The MC68060 is implemented such that when the OVFL bit is set in the FPSR EXC byte as a result of a floating-point instruction, the processor always takes a nonmaskable overflow exception. If the destination is a floating-point data register, then the register is not affected, and a pre-instruction exception is reported. If the destination is a memory or integer data register, an undefined result is stored, and a post-instruction exception is taken immediately. Execution begins at the M68060SP OVFL exception handler to provide MC68881-compatible operation. The M68060SP then determines whether or not control is passed back to normal instruction flow (the OVFL bit in the FPCR exception enable byte is cleared), to the user OVFL handler (the OVFL bit in the FPCR exception enable byte is set), or to the user INEX handler (the OVFL bit in the FPCR exception enable byte is cleared, but the INEX bit in the

FPCR exception enable byte is set and the corresponding INEX bit in the FPSR EXC byte is also set).

6.6.4.1 TRAP DISABLED RESULTS (FPCR OVFL BIT CLEARED). The values defined in Table 6-13 are stored in the destination based on the rounding mode defined in the FPCR MODE byte. The result is rounded according to the rounding precision defined in the FPCR MODE byte if the destination is a floating-point data register. If the destination is in memory or an integer data register, then the rounding precision in the FPCR MODE byte is ignored, and the given destination format defines the rounding precision. If the instruction has a forced rounding precision (e.g., FSADD, FDMUL), the instruction defines the rounding precision.

Table 6-13. Overflow Rounding Mode Values

Rounding Mode	Result
RN	Infinity, with the sign of the intermediate result.
RZ	Largest magnitude number, with the sign of the intermediate result.
RM	For positive overflow, largest positive number; for negative overflow, - infinity.
RP	For positive overflow, + infinity; for negative overflow, largest negative number.



6.6.4.2 TRAP ENABLED RESULTS (FPCR OVFL BIT SET). The result stored in the destination is the same as the result stored when the trap is disabled before control is passed to the user OVFL handler. For an FMOVE OUT instruction, the operand is stored in memory or integer data register, and then control is passed to the user OVFL handler as a post-instruction exception. If the destination is a floating-point data register, control is passed to the user OVFL handler as a pre-instruction exception when the next floating-point operation is encountered.

The user OVFL handler must execute an FSAVE instruction as the first floating-point instruction to prevent further exceptions from being taken. The address of the instruction that causes the overflow is available to the user OVFL handler in the FPIAR. By examining the instruction, the user OVFL handler can determine the arithmetic operation type and destination location. The exception operand is stored in the floating-point state frame (generated by the FSAVE). When an overflow occurs, the exception operand is defined differently for various destination types:

1. FMOVE OUT instruction (memory or integer data register destination)—the value in the exception operand is the intermediate result mantissa rounded to the destination precision, with a 15-bit exponent biased as a normal extended-precision number. In the case of a memory destination, the evaluated effective address of the operand is available in the integer stack frame format \$3. This allows the user OVFL handler to overwrite the default result, if necessary, without recalculating the effective address.
2. Floating-point data register destination—the value in the exception operand is the intermediate result rounded to extended precision, with an exponent bias of \$3FFF-\$6000 rather than \$3FFF. The additional bias of -\$6000 is used so that it is possible to represent the larger exponent in a 15-bit format.

In addition to normal overflow, the exponential instructions (e^x , 10^x , 2^x , SINH, COSH, and FSCALE) may generate results that grossly overflow the 16-bit exponent of the internal

Floating-Point Unit

intermediate result format. When such an overflow occurs (called a catastrophic overflow), the exception operand exponent value is set to \$0000. This value is easily distinguished from the exception operand exponent values produced by normal overflow processing.

If an INEX2 or INEX1 exceptional condition exists and the INEX exception is enabled, it is the responsibility of the user OVFL handler to handle the lower priority inexact exception. The user OVFL exception handler may discard the floating-point state frame once the handler has completed. The RTE instruction must be executed to return to normal instruction flow.

6.6.5 Underflow

An underflow exception occurs when the intermediate result of an arithmetic operation is too small to be represented as a normalized number in a floating-point data register or memory using the selected rounding precision. An arithmetic operation is too small when the intermediate result exponent is less than or equal to the minimum exponent value of the selected rounding precision. Underflow is not detected for intermediate result exponents that are equal to the extended-precision minimum exponent since the explicit integer part bit permits representation of normalized numbers with a minimum extended-precision exponent. Underflow can only occur when the destination format is single, double, or extended precision. When the destination format is byte, word, or long word, the conversion underflows to zero without causing either an underflow or an operand error. At the end of any operation that could potentially underflow, the intermediate result is checked for underflow, rounded, and checked for overflow before it is stored at the destination. If an underflow occurs, the UNFL bit is set in the FPSR EXC byte.

Even if the intermediate result is large enough to be represented as an extended-precision number, an underflow can occur. The intermediate result is rounded to the selected precision, and the rounded result is stored in extended-precision format. If the magnitude of the intermediate result is too small to be represented in the selected rounding precision, an underflow occurs.

The IEEE 754 standard defines two causes of an underflow: 1) when the absolute value of the number is less than the minimum number that can be represented by a normalized number in a specific data format, or 2) when loss of accuracy occurs while attempting to calculate such a number (a loss of accuracy also causes an inexact exception). The IEEE 754 standard specifies that if the underflow exception is disabled, an underflow should only be signaled when both of these cases are satisfied (i.e., the result is too small to be represented with a given format and there is a loss of accuracy during calculation of the final result). If the exception is enabled, the underflow should be signaled any time a very small result is produced, regardless of whether accuracy is lost in calculating it.

The processor UNFL bit in the FPSR AEXC byte implements the IEEE exception disabled definition since it is only set when a very small number is generated and accuracy has been lost when calculating that number. The UNFL bit in the FPSR EXC byte implements the IEEE exception enabled definition since it is set any time a tiny number is generated.

The MC68060 is implemented such that when the UNFL bit of the FPCR is set, the processor always takes an exception regardless of whether or not the user UNFL exception han-

handler is enabled. If the destination is a floating-point data register, the register is not affected, and a pre-instruction exception is reported. If the destination is a memory or integer data register, then an undefined result is stored, and a post-instruction exception is taken immediately. In addition, the processor incorrectly reports an underflow exception if the result of a floating-point multiply is a normalized number with an exponent of \$0000. Exception processing begins with the M68060SP UNFL exception handler to provide MC68881-compatible operation. The M68060SP then determines whether or not control is passed back to normal instruction flow (the OVFL bit in the FPCR exception enable byte is cleared), to the user OVFL handler (the OVFL bit in the FPCR exception enable byte is set) or the user INEX handler (the OVFL bit in the FPCR exception enable byte is cleared, but the INEX bit in the FPCR exception enable byte is set and the corresponding INEX bit in the FPSR EXC byte is also set).

6.6.5.1 TRAP DISABLED RESULTS (FPCR UNFL BIT CLEARED). The result that is stored in the destination is either a denormalized number or zero. Denormalization is accomplished by shifting the mantissa of the intermediate result to the right while incrementing the exponent until it is equal to the denormalized exponent value for the destination format. The denormalized intermediate result is rounded to the selected rounding precision or destination format.



If, in the process of denormalizing the intermediate result, all of the significant bits are shifted off to the right, the selected rounding mode determines the value to be stored at the destination, as shown in Table 6-14.

Table 6-14. Underflow Rounding Mode Values

Rounding Mode	Result
RN	Zero, with the sign of the intermediate result.
RZ	Zero, with the sign of the intermediate result.
RM	For positive overflow, + zero; for negative underflow, smallest denormalized negative number.
RP	For positive overflow, smallest denormalized positive number; for negative underflow, -zero.

6.6.5.2 TRAP ENABLED RESULTS (FPCR UNFL BIT SET). The result stored in the destination is the same as the result stored when traps are disabled. For an FMOVE OUT, the operand is stored in the destination memory or integer data register before control is passed to the user UNFL handler as a post-instruction exception. Otherwise, if the destination is a floating-point data register, control is passed to the user UNFL handler as a pre-instruction exception when the next floating-point instruction is encountered.

Floating-Point Unit

The user UNFL handler must execute an FSAVE instruction as the first floating-point instruction to prevent further exceptions from reporting. The address of the instruction that causes the overflow is available to the user UNFL handler in the FPIAR. By examining the instruction, the user UNFL handler can determine the arithmetic operation type and destination location. The exception operand is stored in the floating-point state frame (generated by the FSAVE). When an underflow occurs, the exception operand is defined differently for various destination types:

1. FMOVE OUT (memory or integer data register destination)—the value in the exception operand is the intermediate result mantissa rounded to the destination precision, with a 15-bit exponent biased as a normal extended-precision number. In the case of a memory destination, the evaluated effective address of the operand is available in the stack frame format \$3. This allows the user UNFL handler to overwrite the default result, if necessary, without recalculating the effective address.
2. Floating-point data register destination—the value in the exception operand is the intermediate result mantissa rounded to extended precision, with an exponent bias of \$3FFF + \$6000 rather than \$3FFF. The additional bias of +\$6000 is used so that it is possible to represent the smaller exponent in a 15-bit format.

In addition to normal underflow, the exponential instructions (e^x , 10^x , 2^x , SINH, COSH, and FSCALE) may generate results that grossly underflow the 16-bit exponent of the internal intermediate format. When such an underflow occurs (called a catastrophic underflow), the exception operand exponent value is set to \$0000. This value is easily distinguished from the exception operand exponent values produced by normal underflow processing.

If an INEX2 or INEX1 exceptional condition exists and the user INEX exception is enabled, it is the responsibility of the user UNFL exception handler to handle this lower priority inexact exception. The user UNFL exception handler may discard the floating-point state frame once the handler has completed. The RTE instruction must be executed to return to normal instruction flow.

6.6.6 Divide-by-Zero

This exception happens when a zero divisor occurs for a divide instruction or when a transcendental function is asymptotic with infinity as the asymptote. Table 6-15 lists the instructions that can cause the divide-by-zero exception. Note that only the FDIV and FSGLDIV instructions are native to the MC68060. The other conditions occur only if the M68060SP is used. When a divide-by-zero is detected, the DZ bit is set in the FPSR EXC byte. The divide-by-zero exception only has maskable exceptional conditions. An exception is taken only if the DZ bit is set in FPSR EXC byte and the corresponding bit in the FPCR exception enable byte is set.

Table 6-15. Possible Divide-by-Zero Exceptions

Instruction	Operand Value
FDIV	Source operand = 0 and floating-point data register is not a NAN, ∞ , or zero
FLOG10	Source operand = 0
FLOG2	Source operand = 0
FLOGN	Source operand = 0
FTAN	Source operand is an odd multiple of $\pm\pi + 2$
FSGLDIV	Source operand = 0 and floating-point data register is not a NAN, ∞ , or zero
FATANH	Source operand = ± 1
FLOGNP1	Source operand = -1

6.6.6.1 TRAP DISABLED RESULTS (FPCR DZ BIT CLEARED). The destination floating-point data register is written with a result that is dependent on the instruction that caused the DZ exception.

1. For the FDIV and FSGLDIV instructions, an infinity with the sign set to the exclusive OR of the signs of the input operands is stored in the destination.
2. For the FLOGx instructions, a $-\infty$ is stored in the destination.
3. For the FATANH instruction, a $+\infty$ is stored in the destination if the source operand is a -1, otherwise, a $-\infty$ is stored in the destination if the source operand is +1.

6.6.6.2 TRAP ENABLED RESULTS (FPCR DZ BIT SET). The destination floating-point data register is not modified. Control is passed to the user DZ handler as a pre-instruction exception when the next floating-point instruction is encountered. The user DZ handler must generate a result to store in the destination.

The user DZ handler must execute an FSAVE instruction as the first floating-point instruction to prevent further exceptions from reporting. The address of the instruction that causes the overflow is available to the user DZ handler in the FPIAR. By examining the instruction, the user DZ handler can determine the arithmetic operation type and destination location. The exception operand is stored in the floating-point state frame (generated by the FSAVE). The exception operand contains the source operand converted to the extended-precision format. When the user DZ exception handler has completed, the floating-point frame may be discarded. The RTE instruction must be executed to return to normal instruction flow.

6.6.7 Inexact Result

The processor provides two inexact bits in the FPSR EXC byte to help distinguish between inexact results generated by emulated decimal input (INEX1 exceptions) and other inexact results (INEX2 exceptions). These two bits are useful in instructions where both types of inexact results can occur (e.g., FDIV.P #7E-1,FP3). In this case, the packed decimal to extended-precision conversion of the immediate source operand causes an inexact error to occur that is signaled as INEX1 exception. Furthermore, the subsequent divide could also produce an inexact result and cause INEX2 to be set in the FPCR EXC byte. Note that only one inexact exception vector number is generated by the processor. If either of the two inexact exceptions is enabled, the processor fetches the inexact exception vector, and the user INEX exception handler is initiated. INEX refers to both exceptions in the following paragraphs.

Floating-Point Unit

The INEX2 exception is the condition that exists when any operation, except the input of a packed decimal number, creates a floating-point intermediate result whose infinitely precise mantissa has too many significant bits to be represented exactly in the selected rounding precision or in the destination data format. If this condition occurs, the INEX2 bit is set in the FPSR EXC byte, and the infinitely precise result is rounded. Table 6-16 lists these rounding mode values.

Table 6-16. Rounding Mode Values

Rounding Mode	Result
RN	The representable value nearest to the infinitely precise intermediate value is the result. If the two nearest representable values are equally near (a tie), then the one with the least significant bit equal to zero (even) is the result. This is sometimes referred to as "round to nearest, even."
RZ	The result is the value closest to and no greater in magnitude than the infinitely precise intermediate result. This is sometimes referred to as the "chop mode," since the effect is to clear the bits to the right of the rounding point.
RM	The result is the value closest to and no greater than the infinitely precise intermediate result (possibly minus infinity).
RP	The result is the value closest to and no less than the infinitely precise intermediate result (possibly plus infinity).

The INEX1 and INEX2 exceptions are always maskable. Therefore, any INEX exception goes directly to the user INEX exception handler. When an INEX2 or INEX1 bit in the FPSR EXC byte is set, the rounded result (listed in Table 6-16), is written to the destination. The FPCR MODE bits determine the rounding mode. The PREC bits in the FPCR determine the rounding precision if the destination is a floating-point data register; otherwise, if the destination is memory or an integer data register, the destination format determines the rounding precision. If one of the instructions has a forced precision, the instruction determines the rounding precision. If the INEX2 or INEX1 condition exists and if the corresponding INEX bit in the FPCR exception enable byte is set, then the user INEX exception handler is taken.

6.6.7.1 TRAP DISABLED RESULTS (FPCR INEX1 BIT AND INEX2 BIT CLEARED). The result is rounded and then written to the destination.

6.6.7.2 TRAP ENABLED RESULTS (EITHER FPCR INEX1 BIT OR INEX2 BIT SET). The result is rounded and then written to the destination as in the trap disabled case. For an FMOVE OUT instruction, control is passed to the user INEX handler as a post-instruction exception. Otherwise, for other floating-point instructions that have floating-point data register destinations, control is passed to the user INEX handler as a pre-instruction exception when the next floating-point instruction is encountered.

The user INEX exception handler must execute an FSAVE as its first floating-point instruction. At this point, the destination contains the rounding mode values as listed in Table 6-16, and the user INEX exception handler can choose to modify these values. If the inexact conversion is the only exception that occurs during the execution of an instruction, the value of the exception operand is invalid. If multiple exceptions occur during an instruction, the exception operand value is related to a higher priority exception. The FPIAR points to the instruction that caused the exception. If the instruction is an FMOVE OUT, the integer stack frame format \$3 contains the effective address of the destination memory operand. If the destination is an integer data register, the effective address field is undefined.

When the user INEX exception handler has completed, the floating-point frame may be discarded. The RTE instruction must be executed to return to normal instruction flow.

NOTE

The IEEE 754 standard specifies that inexactness should be signaled on overflow as well as for rounding. The processor implements this via the INEX bit in the FPSR AEXC byte. However, the standard also indicates that the inexact exception should be taken if an overflow occurs with the OVFL bit disabled and the INEX bit enabled in the FPSR AEXC byte. Therefore, the processor takes the inexact exception if this combination of conditions occurs, even though the INEX1 or INEX2 bit may not be set in the FPSR EXC byte. In this case, the INEX bit is set in the FPSR AEXC byte, and the OVFL bit is set in both the FPSR EXC and AEXC bytes.



6.7 FLOATING-POINT STATE FRAMES

All floating-point arithmetic exception handlers must have FSAVE as the first floating-point instruction; any other floating-point instruction causes another exception to be reported. Once the FSAVE instruction has executed, the exception handler should use only the FMOVEM instruction to read or write to the floating-point data registers since FMOVEM cannot generate further exceptions or change the FPCR.

An FSAVE instruction is executed to save the current floating-point internal state for context switches and floating-point exception handling. When an FSAVE is executed, the processor waits until the FPU either completes the instruction or is unable to perform further processing due to a pending exception that must be serviced.

FSAVE operations always write a floating-point state frame containing three long words. The exception operand, is part of the EXCP frame. This exception operand retains its value when FRESTORED as an EXCP frame into the processor and then FSAVED at a later time. The FSAVE frame contents are shown in Figure 6-10 and the status word contents are shown in Figure 6-11.

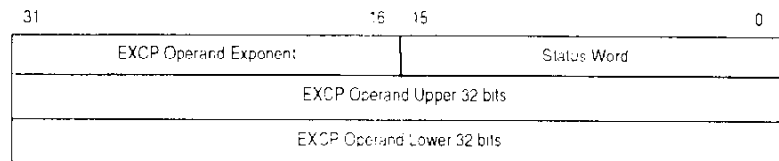

Figure 6-10. Floating-Point State Frame

Bits 15–8 of the first long word of the floating-point frame define the frame format. The legal formats for the MC68060 are:

- \$00 Null Frame (NULL)
- \$60 Idle Frame (IDLE)
- \$E0 Exception Frame (EXCP)

Floating-Point Unit

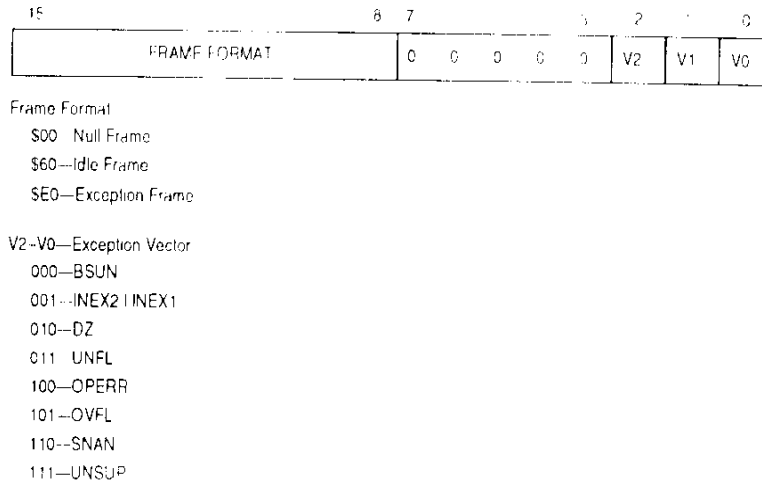

Figure 6-11. Status Word Contents

FSAVE on the MC68060 only generates one size frame (three long words), which creates a significant performance benefit, and one of these three frame types. An attempt to FRESTORE a frame format other than \$00, \$60, or \$E0 results in a format error exception.

The format of the first long word of the MC68060 floating-point frame has changed from that of previous M68000 microprocessors. The MC68060 frame format (bits 15–8) is a consolidation of the version number and size format information (bits 31–16) on previous parts. In addition, on the MC68060, this information resides in the lower word of the long word while the upper word is used for the exception operand exponent in EXCP frames. Therefore, FRESTORE of a frame on an MC68060 created by FSAVE on a non-MC68060 microprocessor and FRESTORE of a frame on a non-MC68060 microprocessor created by FSAVE on an MC68060 will not guarantee a format error exception will be detected and thus must never be attempted.

When an FSAVE is executed, the floating-point frame reflects the state of the FPU at the time of the FSAVE. Internally, the FPU can be in the NULL, IDLE or EXCP states. Upon reset, the FPU is in the NULL state. In the NULL state, all floating-point registers contain nonsignaling NaNs and the FPCR, FPSR, and FPIAR contain zeroes. The FPU remains in this state until the execution of an implemented floating-point instruction (except FSAVE). At this point, the FPU transitions from a NULL state to an IDLE state. An FRESTORE of NULL returns the FPU to the NULL state. The EXCP state is entered as a result of either a floating-point exception or an unsupported data type exception. V2–V0 indicates the exception types that are associated with the EXCP state.

An FSAVE instruction always clears the internal exception status bit at the completion of the FSAVE. An FRESTORE of EXCP may be used to place the FPU in the exception state.

The FRESTORE of an EXCP state is used in the M68060SP to provide to the user exception handler the illusion that the M68060SP handler never existed at all. The user exception handler is entered with the FPU in the proper exception state. The user

exception handler then executes an FSAVE instruction to clear the internal exception status bit in the FPU. To return to normal operation, the user exception handler may either clear the most significant bit of the frame format (changing the frame format from \$E0 to \$60, creating an IDLE frame) prior to FRESTOREing the IDLE state frame, or discarding the floating-point frame before executing the RTE. Given that the state frames are of a fixed size (three long words), it is quicker to simply discard the state frame.

The exception operand provided in the floating-point frame is dependent on the highest priority exception that is reported. The exception operand as generated by the processor when the exception is first reported may be undefined. The M68060SP calculates the proper exception operand and executes an FRESTORE of the EXCP frame with the proper exception operand value in the floating-point frame. When the user exception handler is entered, the required FSAVE inside the user exception handler generates the floating-point frame and retrieves the exception operand, as calculated by the M68060SP.

The exception operand provided to the user exception handler is defined as follows for the possible exceptions:

BSUN User Handler—Undefined.

SNAN, OPERR, DZ—Source operand in extended-precision format.

OVFL—Intermediate result in extended-precision format, but with exponent bias of \$3FFF-\$6000 instead of \$3FFF. If catastrophic overflow, \$0.

UNFL—Intermediate result in extended-precision format but with exponent bias of \$3FFF+\$6000 instead of \$3FFF. If catastrophic underflow, \$0.

INEX—Undefined if INEX only. Otherwise if either SNAN, OPERR, UNFL, or OVFL also set in FPSR, use exception operand defined for either SNAN, OPERR, UNFL, or OVFL.

SECTION 7 BUS OPERATION

The MC68060 bus interface supports synchronous data transfers between the processor and other devices in the system. This section provides a functional description of the bus, the signals that control the bus, and the bus cycles provided for data transfer operations. Operation of the bus is defined for transfers initiated by the processor as a bus master and for transfers initiated by an alternate bus master which the processor snoops as a slave device. Descriptions of the error and halt conditions, bus arbitration, and the reset operation are also included. For timing specifications, refer to **Section 12 Electrical and Thermal Characteristics**.

7.1 BUS CHARACTERISTICS

The MC68060 uses the address bus (A31A0) to specify the address for a data transfer and the data bus (D31–D0) to transfer the data. Control and attribute signals indicate the beginning and type of a bus cycle as well as the address space and size of the transfer. The selected device then controls the length of the cycle by terminating it using the control signals.

The MC68060 CLK is distributed internally to provide logic timing. $\overline{\text{CLKEN}}$ indicates important rising CLK edges for the bus interface controller but does not directly affect internal operation or timing of the MC68060. Its main purpose is to allow for easier system design. $\overline{\text{CLKEN}}$ makes possible full-, half-, and quarter-speed bus operation by providing a signal to qualify valid rising CLK edges. In general, on rising CLK edges in which $\overline{\text{CLKEN}}$ is asserted, inputs are sampled and outputs begin to change. However, there are some inputs that are sampled and outputs that transition on rising CLK edges when $\overline{\text{CLKEN}}$ is negated.

Inputs to the MC68060 (other than the $\overline{\text{IPLx}}$ and $\overline{\text{RSTI}}$ signals) are synchronously sampled and must be stable during the sample window defined by t_{su} and t_{hi} (see Figure 7-1) to guarantee proper operation. The asynchronous $\overline{\text{IPLx}}$ and $\overline{\text{RSTI}}$ signals are sampled on the rising edge of CLK, but are internally synchronized to resolve the input to a valid level before being used. Since the timing specifications for the MC68060 are referenced to the rising edge of CLK, they are valid only for the specified operating frequency and must be scaled for lower operating frequencies.

Outputs to the MC68060 begin to transition on rising CLK edges in which $\overline{\text{CLKEN}}$ is asserted. However, when $\overline{\text{BB}}$ and $\overline{\text{TIP}}$ transition from being asserted to being three-stated, they are driven negated for one CLK before they are three-stated. Refer to Figure 7-2, Figure 7-3, and Figure 7-4 for an illustration. Furthermore, the processor status signals (PSTx), $\overline{\text{RSTO}}$, and $\overline{\text{IPEND}}$ output signals are updated on rising edges of CLK regardless of the $\overline{\text{CLKEN}}$ input.

Bus Operation

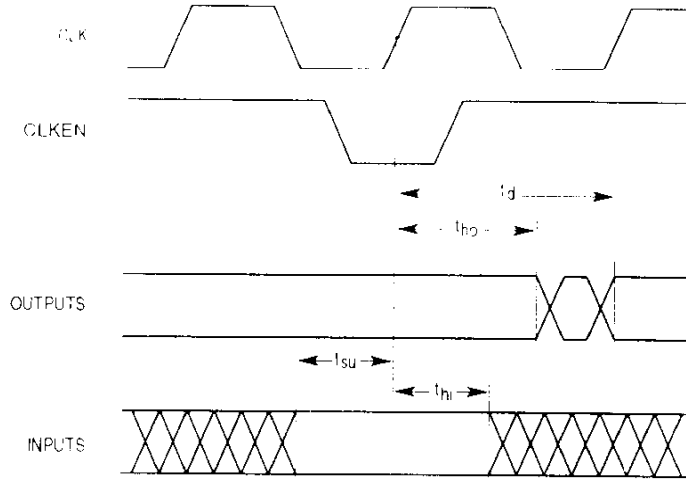

NOTES:

1. t_d ... Propagation delay of signal relative to CLK rising edge.
2. t_{ho} ... Output hold time relative to CLK rising edge.
3. t_{su} ... Required input setup time relative to CLK rising edge.
4. t_{hi} ... Required input hold time relative to CLK rising edge.

Figure 7-1. Signal Relationships to Clocks

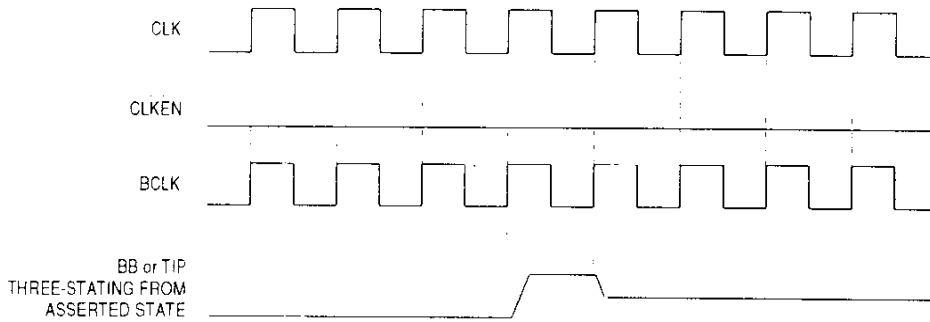

Figure 7-2. Full-Speed Clock

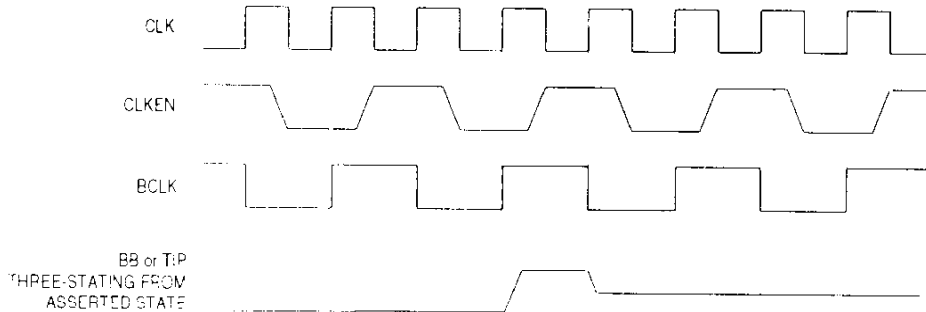

Figure 7-3. Half-Speed Clock

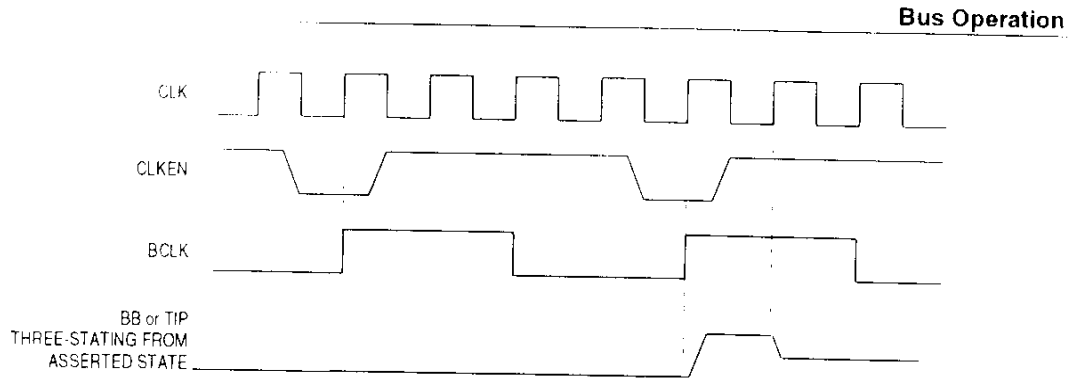

Figure 7-4. Quarter-Speed Clock

7.2 FULL-, HALF-, AND QUARTER-SPEED BUS OPERATION AND BCLK

To simplify the description of full-, half-, and quarter-speed bus operation, the term "bus clock" or "BCLK" is introduced to describe the effective frequency of bus operation. The bus clock is analogous to the MC68040 clock input called BCLK. The MC68040 BCLK defines when input signals are sampled and when output signals begin to transition. Once the relationship of CLK, CLKEN, and the virtual BCLK is established, it is possible to describe the MC68060 bus more easily, relative to BCLK.



CLKEN allows the bus to synchronize to BCLK which is running at half or quarter speed of the processor clock (CLK). On rising CLK edges in which CLKEN is asserted, inputs to the processor are recognized and outputs of the processor may begin to assert, negate, or three-state. On rising CLK edges in which CLKEN is negated, no inputs are recognized and no outputs begin to change (except BB and TIP). Figure 7-1 illustrates the general relationship between CLK, CLKEN, and most input and output signals.

For brevity, the term "full-speed bus" is introduced to refer to systems in which BCLK is running at the same frequency as CLK. The term "half-speed bus" refers to systems in which BCLK is running at half the frequency of CLK. For those familiar with the MC68040, the half-speed bus is analogous to the MC68040 implementation. The term "quarter-speed bus" refers to systems in which BCLK is running at one quarter the frequency of CLK. The MC68060 clocking mechanism is designed so that systems designed today can be upgraded with higher-frequency MC68060s, without forcing the rest of the system to operate at the same higher processor frequency. This flexibility also allows the MC68060 to be used in existing MC68040 system designs.

A full-speed bus design is achieved by continuously asserting CLKEN as shown in Figure 7-2. A half speed bus is achieved by asserting CLKEN about every other rising edge of CLK. Figure 7-3 shows a timing diagram of the relationship between CLK, CLKEN, and BCLK for half-speed bus operation. A quarter-speed bus is achieved by asserting CLKEN once about every four rising edges of CLK. Figure 7-4 shows a timing diagram of the relationship between CLK, CLKEN, and BCLK for quarter-speed bus operation.

Note that once BCLK has been established, inputs and outputs appear to be synchronized to this virtual BCLK. To simplify the description of MC68060 bus operation, the rising edges

Bus Operation

of BCLK represent the rising edges of CLK in which $\overline{\text{CLKEN}}$ is asserted. However, there are cases in which the BCLK concept does not apply.

The BCLK concept does not apply to the $\overline{\text{IPLx}}$ and $\overline{\text{RSTI}}$ input signals. These inputs are sampled every CLK edge. The processor status (PSTx), $\overline{\text{RSTO}}$, and $\overline{\text{IPEND}}$ outputs do not follow the BCLK concept, either, since these outputs can change on any CLK rising edge, regardless of $\overline{\text{CLKEN}}$. The $\overline{\text{BB}}$ and $\overline{\text{TIP}}$ signals generally follow the BCLK concept except when these signals are already driven asserted by the processor and then three-stated. This occurs when the bus is arbitrated away from the processor immediately after an active bus cycle. These outputs are actively negated for one CLK period before three-stating. Figure 7-2, Figure 7-3, and Figure 7-4 illustrate the behavior of $\overline{\text{BB}}$ and $\overline{\text{TIP}}$ in the case mentioned. The $\overline{\text{BB}}$ signal is not recommended for use in full-speed bus designs since bus contention is possible when tied to alternate masters' $\overline{\text{BB}}$ pins.

Other implementations of $\overline{\text{CLKEN}}$ are not supported.

7.3 ACKNOWLEDGE TERMINATION IGNORE STATE CAPABILITY

The MC68060 provides the capability to ignore termination acknowledgments to assist in system designs. Independent ignore state counters for read and write, primary (initial) transfer, and secondary (burst) transfer are used during bus cycles to determine which BCLK rising edges transfer acknowledge termination signals should be ignored or sampled.

This special mode is selected during a reset operation. Please refer to **7.14 Special Modes of Operation** for details on how to enable this mode.

7.4 BUS CONTROL REGISTER

The bus control register (BUSCR) is accessed via the MOVEC instruction. Its main purpose is to provide a way to control the external $\overline{\text{LOCK}}$ and $\overline{\text{LOCKE}}$ signals in software. This feature is essential in emulating the CAS2 instruction and in providing a means to control bus arbitration activity during critical code segments. Figure 7-5 shows the BUSCR format.

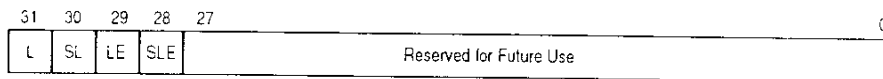

Figure 7-5. Bus Control Register Format

L—Lock Bit

- 0 = Negate external $\overline{\text{LOCK}}$ signal.
- 1 = Assert external $\overline{\text{LOCK}}$ signal.

SL—Shadow Copy, Lock Bit

- 0 = $\overline{\text{LOCK}}$ negated sequence at time of exception.
- 1 = $\overline{\text{LOCK}}$ asserted at time of exception.

LE—Lock End Bit

- 0 = Negate external $\overline{\text{LOCKE}}$ signal.
- 1 = Assert external $\overline{\text{LOCKE}}$ signal.

SLE—Shadow Copy, Lock End Bit

- 0 = $\overline{\text{LOCKE}}$ asserted at time of exception.
- 1 = $\overline{\text{LOCKE}}$ negated at time of exception.

The external $\overline{\text{LOCK}}$ signal is asserted starting with the assertion of $\overline{\text{TS}}$ for the bus cycle of the next operand read or write after setting the L-bit in the BUSCR. The external $\overline{\text{LOCKE}}$ signal is asserted starting with the assertion of $\overline{\text{TS}}$ for the bus cycle of the next operand write after setting the LE bit in the BUSCR. Both the $\overline{\text{LOCK}}$ and $\overline{\text{LOCKE}}$ external signals are negated the cycle after the final $\overline{\text{TA}}$ assertion associated with the $\overline{\text{TS}}$ that asserted $\overline{\text{LOCKE}}$. The final operand write cycle must not be misaligned. A final write to the BUSCR must be made in order to clear the L and LE bits even though the external signals have already negated. The L and LE bits are cleared when the processor is reset.

The SL and SLE bits in the BUSCR are provided to retain a copy of the L and LE bits at the time of an exception. When an exception occurs, the MC68060 copies the L and LE bits to the SL and SLE bits respectively, negates the external $\overline{\text{LOCK}}$ and $\overline{\text{LOCKE}}$ pins, and clears the L and LE bits. It is recommended that all interrupts be masked prior to the use of BUSCR. If the cause of the exception is an access error, a bit in the fault status long word (FSLW) in the access error frame is used to signify that a locked sequence was being executed at the time of the fault.



7.5 DATA TRANSFER MECHANISM

Figure 7-6 illustrates how the bus designates operands for transfers on a byte boundary system. The integer unit handles floating-point operands as a sequence of related long-word operands. These designations are used in the figures and descriptions that follow.

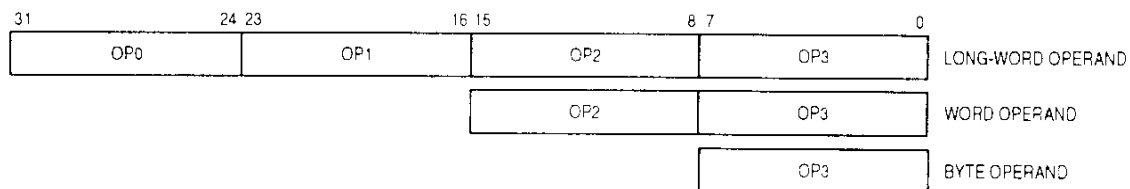

Figure 7-6. Internal Operand Representation

Figure 7-7 illustrates general multiplexing between an internal register and the external bus. The internal register connects to the external data bus through the internal data bus and multiplexer. The data multiplexer establishes the necessary connections for different combinations of address and data sizes.

Unlike the MC68020 and MC68030 processors, the MC68060 does not support dynamic bus sizing and expects the referenced device to accept the requested access width. The MC68150 dynamic bus sizer is designed to allow the 32-bit MC68060 bus to communicate

Bus Operation

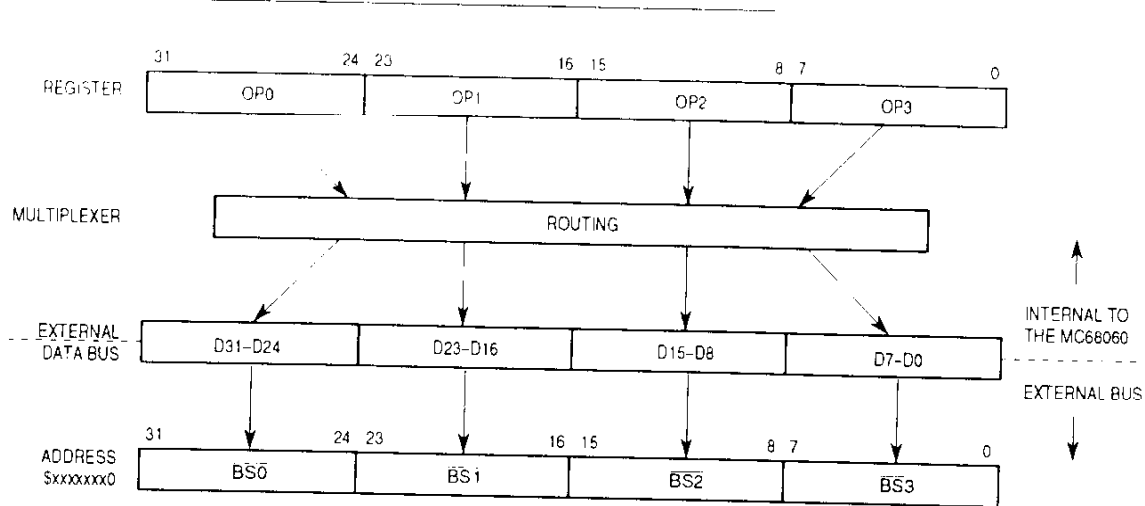

Figure 7-7. Data Multiplexing

bidirectionally with 32-, 16-, or 8-bit peripherals and memories. It dynamically recognizes the size of the selected peripheral or memory device and then reads or writes the appropriate data from that location. Refer to *MC68150/D, MC68150 Dynamic Bus Sizer*, for information on this device.

Blocks of memory that must be contiguous, such as for code storage or program stacks, must be 32 bits wide. Byte- and word-sized I/O ports that return an interrupt vector during interrupt acknowledge cycles must be mapped into the low-order 8 or 16 bits, respectively, of the data bus.

The multiplexer takes the four bytes of a long-word transfer and routes them to their required positions. For example, OP0 would normally be routed to D31-D24 on an aligned long-word transfer, but it can also be routed to any other byte position supporting a misaligned data transfer. The same is true for any of the other operand bytes. The transfer size (SIZ0 and SIZ1) and byte offset (A1 and A0) signals determine the positioning of the bytes (see Table 7-1) or alternatively, $\overline{BS3}-\overline{BS0}$ may be used instead of SIZx, A1, and A0. The \overline{BSx} pins determine which byte sections are active. The size indicated on the SIZx signals corresponds to the size of the operand transfer for the entire bus cycle (except for burst-inhibited bus cycles). During an operand transfer, A31-A2 indicate the long-word base address for the first byte of the operand to be accessed; A1 and A0 indicate the byte offset from the base. For long-word or line bus cycles, external logic must ignore address bits A1 and A0 for proper operation.

Table 7-1. Data Bus Requirements for Read and Write Cycles

Transfer Size	Signal Encoding				Active Data Bus Sections and Byte Enables			
	SIZ1	SIZ0	A1	A0	D31–D24 BS0	D23–D16 BS1	D15–D8 BS2	D7–D0 BS3
Byte	0	1	0	0	—	—	—	—
	0	1	0	1	OP3	—	—	—
	0	1	1	0	—	OP3	—	—
	0	1	1	1	—	—	OP3	OP3
Word	1	0	0	0	OP2	OP3	—	—
	1	0	1	0	—	—	OP2	OP3
Long Word	0	0	X	X	OP0	OP1	OP2	OP3
Line	1	1	X	X	OP0	OP1	OP2	OP3

Table 7-1 lists the combinations of the SIZx, A1, and A0 signals, collectively called byte enable signals, that are used for each of the four sections of the data bus. Alternatively, the BSx signals may be used for byte selection. In Table 7-1, OP0–OP3 indicates the portion of the requested operand that is read or written during that bus transfer. For line and long-word transfers, all bytes are valid as listed and can correspond to portions of the requested operand or to data required to fill the remainder of the cache line. The bytes labeled with a dash are not required; they are ignored on read transfers and driven with undefined data on write transfers. Not selecting these bytes prevents incorrect accesses in sensitive areas such as I/O devices. Figure 7-8 illustrates a logic diagram for one method for generating byte select signals from SIZx, A1, and A0 and the associated PAL equation. The logic shown in Figure 7-8 is equivalent to the internal logic used to generate the external byte select signals (BSx) provided by the processor. Byte enable signals derived from the SIZx, A1, and A0 signals, or alternatively, the external BSx signals, can be combined with the address or other attributes signals to generate the decode logic of a system.



The MC68060 provides BSx so that it is unnecessary to use the SIZx, A1, and A0 signals to generate byte selects using external logic. This aids in high-speed system design. Figure 7-7, Figure 7-8, and Table 7-1 show the relationship between SIZx, A1, A0, and BSx.

A brief summary of the bus signal encoding for each access type is listed in Table 7-2. Additional information on the encoding for the MC68060 signals can be found in **Section 2 Signal Description**.

Bus Operation

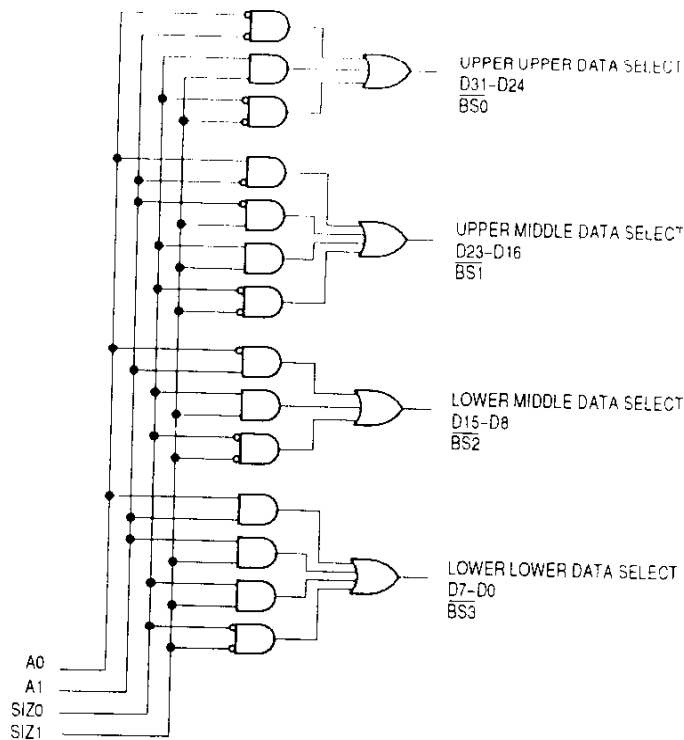

PAL16L8
 U1
 MC68060 Byte Data Select Generation.
 A0 A1 SIZ0 SIZ1 NC NC NC NC NC NC GND NC UUD UMD LMD LLD
 NC NC NC NC VCC

```

/UUD =  /A0 * /A1      ; directly addressed, any size
        + /SIZ1 * /SIZ0 ; enable every byte for long-word size
        + SIZ1 * SIZ0  ; enable every byte for line size
/UMD =  A0 * /A1      ; directly addressed, any size
        + /A1 * /SIZ1 ; word aligned, size is word or line
        + SIZ1 * SIZ0 ; enable every byte for long-word size
        + /SIZ1 * /SIZ0 ; enable every byte for line size
/LMD =  /A0 * /A1      ; directly addressed, any size
        + /SIZ1 * /SIZ0 ; enable every byte for long-word size
        + SIZ1 * SIZ0  ; enable every byte for line size
/LLD =  A0 * /A1      ; directly addressed, any size
        + /A1 * /SIZ1 ; word aligned, word or line size
        + SIZ1 * SIZ0 ; enable every byte for long word size
        + /SIZ1 * /SIZ0 ; enable every byte for line size
    
```

Figure 7-8. Byte Select Signal Generation and PAL Equation

Table 7-2. Summary of Access Types vs. Bus Signal Encoding

Bus Signal	Data Cache Push Access	Normal Data/ Code Access	Table Search Access	MOVE16 Access	Alternate Access	Interrupt Acknowledge	LPSTOP Broadcast Cycle	Breakpoint Acknowledge
A31-A0	Access Address	Access Address	Entry Address	Access Address	Access Address	FFFFFFFF	FFFFFFFE	00000000
UPA1, UPA0	\$0	MMU Source ¹	\$0	MMU Source ¹	\$0	\$0	\$0	\$0
SIZ1, SIZ0	L/Line	B/W/L/Line	Long Word	Line	B/W/L	Byte	Word	Byte
TT1, TT0	\$0	\$0	\$0	\$1	\$2	\$3	\$3	\$3
TM2-TM0	\$0	\$1,2,5, or 6	\$3 or 4	\$1 or 5	Function Code=0,3,4,7 Debug Access=1,5,6	Int. Level \$1-7	\$0	\$0
TLN1, TLN0	Cache Set Entry	Cache Set Entry ²	Undefined	Undefined	Undefined	Undefined	Undefined	Undefined
R/W	Write	Read/Write	Read/Write	Read/Write	Read/Write	Read	Write	Read
LOCK, LOCKE	Negated	Asserted/Negated ³	Asserted/Negated ³	Negated	Negated	Negated	Negated	Negated
CIOUT	Negated	MMU Source ¹	Negated	MMU Source ¹	Asserted	Negated	Negated	Negated

NOTES

- 1) The UPA1, UPA0, and CIOUT signals are determined by the U1, U0, and CM bit fields, respectively, corresponding to the access address.
- 2) The TLNx signals are defined only for normal push accesses and normal data line read accesses.
- 3) The LOCK signal is asserted during TAS and CAS operand accesses and for some table search update sequences. LOCKE is asserted for the last bus cycle of a locked sequence of bus cycles. LOCK and LOCKE may also be asserted after the execution of a MOVEC instruction that sets the L or LE bit, respectively, in the BUSCR (see 7.4 Bus Control Register).
- 4) Refer to Section 2 Signal Description for definitions of the TMx signal encoding for normal, MOVE16, and alternate accesses.

7.6 MISALIGNED OPERANDS

All MC68060 data formats can be located in memory on any byte boundary. A byte operand is properly aligned at any address, a word operand is misaligned at an odd address, and a long word is misaligned at an address that is not evenly divisible by four. However, since operands can reside at any byte boundary, they can be misaligned. Although the MC68060 does not enforce any alignment restrictions for data operands (including program counter (PC) relative data addressing), some performance degradation occurs when additional bus cycles are required for long-word or word operands that are misaligned. For maximum performance, data items should be aligned on their natural boundaries. All instruction words and extension words must reside on word boundaries. Attempting to prefetch an instruction word at an odd address causes an address error exception. Refer to Section 8 Exception Processing for details on address error exceptions.

The MC68060 data memory unit converts misaligned operand accesses that are noncacheable to a sequence of aligned accesses. These aligned accesses are then sent to the bus controller for completion, always resulting in aligned bus transfers. Misaligned operand accesses that miss in the data cache are cacheable and are not aligned before line filling. Refer to Section 5 Caches for details on line fill and the data cache.



Bus Operation

Figure 7-9 illustrates the transfer of a long-word operand from an odd address requiring more than one bus cycle. For the first transfer or bus cycle, the SIzX signals specify a byte transfer, and the byte offset is \$1. The slave device supplies the byte and acknowledges the data transfer. When the processor starts the second cycle, the SIzX signals specify a word transfer with a byte offset of \$2. The next two bytes are transferred during this cycle. The processor then initiates the third cycle, with the SIzX signals indicating a byte transfer. The byte offset is now \$0; the port supplies the final byte and the operation is complete. This example is similar to the one illustrated in Figure 7-10 except that the operand is word sized and the transfer requires only two bus cycles. Figure 7-11 illustrates a functional timing diagram for a misaligned long-word read transfer.

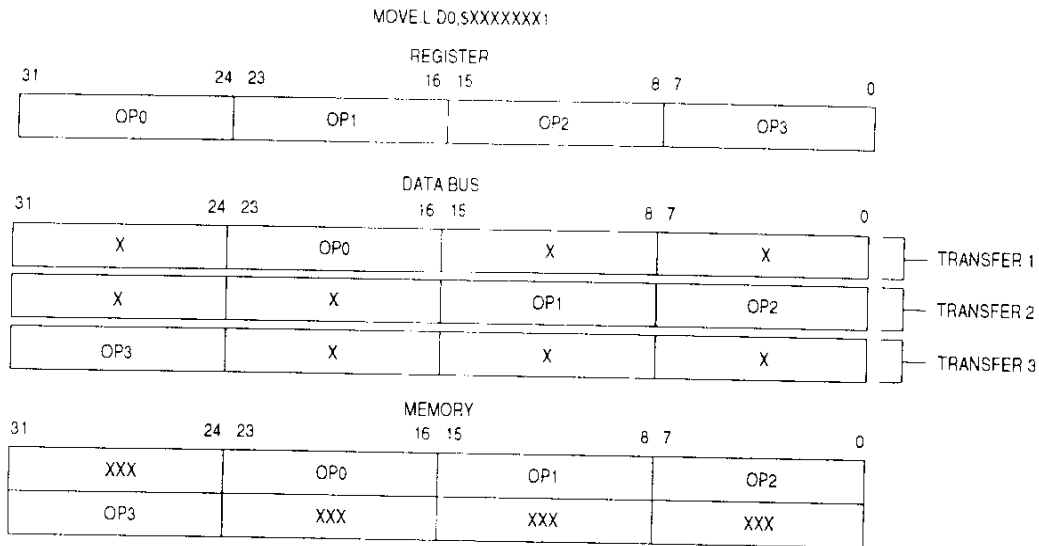

Figure 7-9. Example of a Misaligned Long-Word Transfer

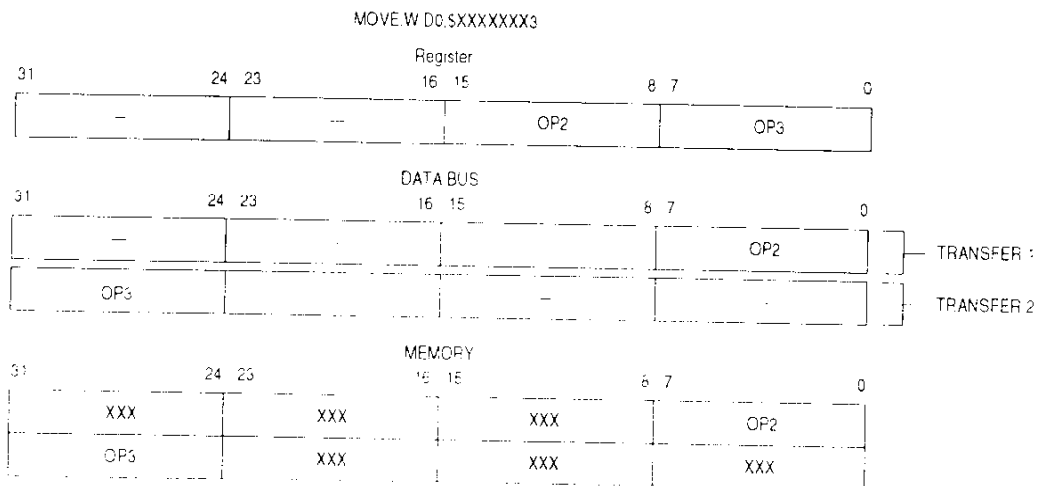

Figure 7-10. Example of Misaligned Word Transfer

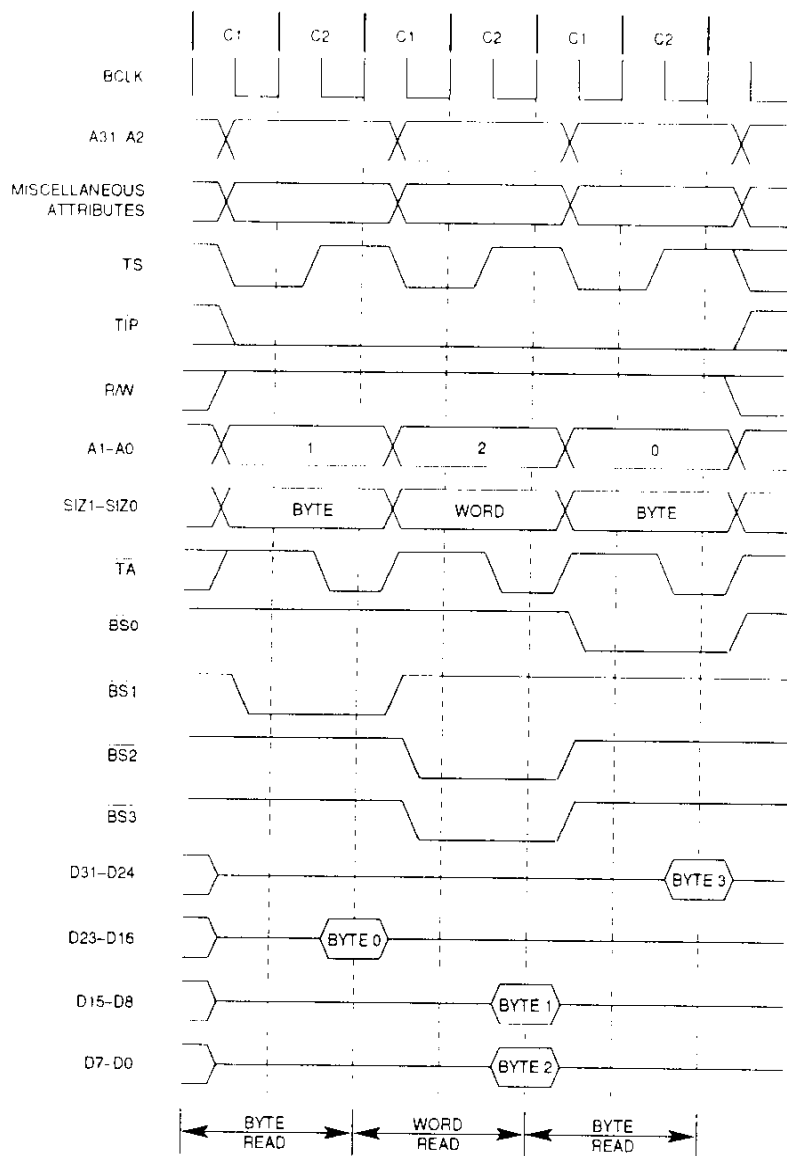

Figure 7-11. Misaligned Long-Word Read Bus Cycle Timing

The combination of operand size and alignment determines the number of bus cycles required to perform a particular memory access. Table 7-3 lists the number of bus cycles required for different operand sizes with all possible alignment conditions for read and write cycles. The table confirms that alignment significantly affects bus cycle throughput for non-cachable accesses. For example, in Figure 7-9 the misaligned long-word operand took three bus cycles because the byte offset = \$1. If the byte offset = \$0, then it would have taken one

Bus Operation

bus cycle. The MC68060 system designer and programmer should account for these effects, particularly in time-critical applications.

Table 7-3. Memory Alignment Influence on Noncachable and Writethrough Bus Cycles

Transfer Size	Number of Bus Cycles			
	\$0*	\$1*	\$2*	\$3*
Instruction	1	N/A	N/A	N/A
Byte Operand	1	1	1	1
Word Operand	1	2	1	2
Long-Word Operand	1	3	2	3

*Where the byte offset (A1 and A0) equals this encoding.

7.7 PROCESSOR DATA TRANSFERS

The transfer of data between the processor and other devices involves the address bus, data bus, and control and attribute signals. The address and data buses are normally parallel, nonmultiplexed buses, supporting byte, word, long-word, and line (16-byte) bus cycles. Line transfers are normally performed using an efficient burst transfer, which provides an initial address and time-multiplexes the data bus to transfer four long words of information to or from the slave device. Slave devices that do not support bursting can burst-inhibit the first long word of a line transfer, forcing the bus master to complete the access using three additional long-word bus cycles. All bus input and output signals are synchronized with respect to the rising edge of the BCLK signal. The MC68060 moves data on the bus by issuing control signals and using a handshake protocol to ensure correct data movement. The following paragraphs describe the bus cycles for byte, word, long-word, and line read, write, and read-modify-write transfers.

In general, the bus cycle protocol supported by the MC68060 processor is similar to that supported by the MC68040 processor. In addition to the basic MC68060 protocol, there are special modes that can be selected during reset by selectively setting the \overline{IPLx} and data bus D15–D0. For the purpose of simplifying the description of the MC68060 bus, this sub-section, **7.7 Processor Data Transfers**, describes the behavior of the MC68060 processor assuming that none of the special modes are selected during reset. For the description of the MC68060 bus cycle protocol when the special modes are enabled, refer to **7.14 Special Modes of Operation**.

7.7.1 Byte, Word, and Long-Word Read Transfer Cycles

During a read transfer, the processor receives data from a memory or peripheral device. Since the data read for a byte, word, or long-word access is not placed in either of the internal caches by definition, the processor ignores the transfer cache inhibit (\overline{TCI}) signal when registering the data. The bus controller performs byte, word, and long-word read transfers for the following cases:

- Accesses to a disabled cache
- Accesses to a memory page that is specified noncachable
- Accesses that are implicitly noncachable (locked read-modify-write accesses, accesses to an alternate logical address space via the MOVES instruction, and table searches)

- Accesses that do not allocate in the data cache on a read miss (exception vector fetches, and exception stack deallocation for an RTE instruction)
- The first transfer of a line read is terminated with transfer burst inhibit (\overline{TBI}), forcing completion of the line access using three additional long-word read transfers

Figure 7-12 is a flowchart for byte, word, and long-word read transfers. Bus operations are similar for each case and vary only with the size indicated and the portion of the data bus used for the transfer. Figure 7-13 is a functional timing diagram for byte, word, and long-word read transfers.

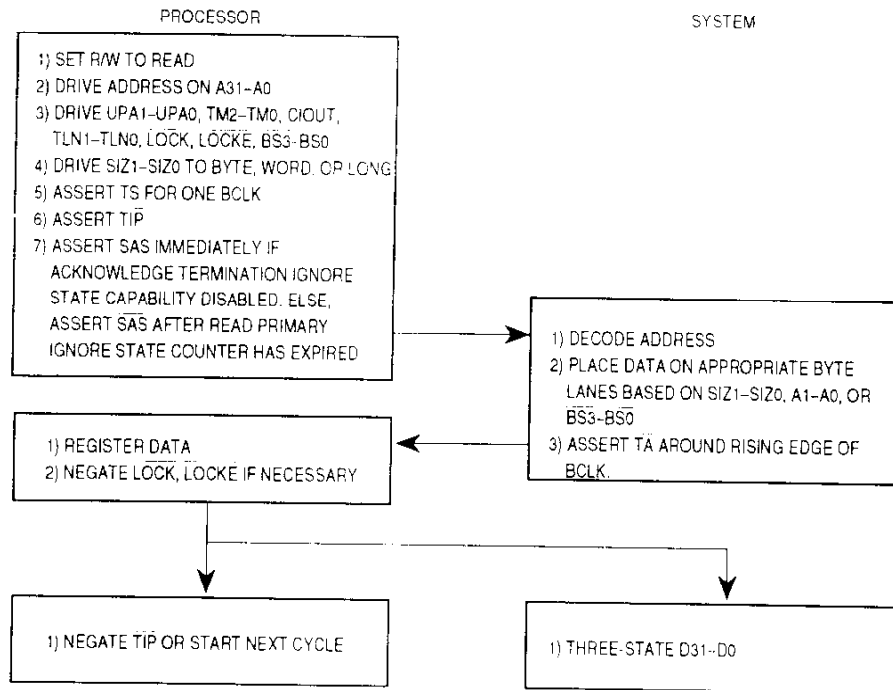
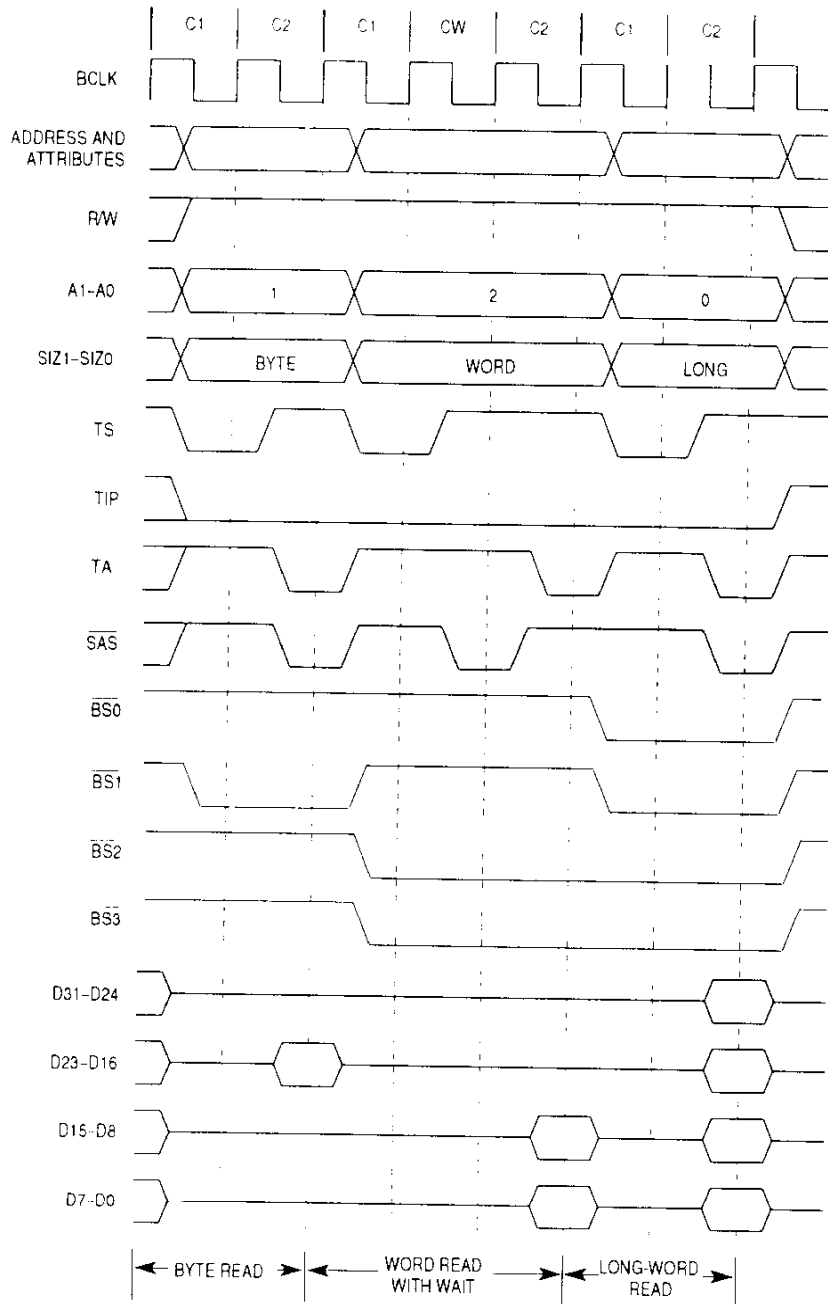

Figure 7-12. Byte, Word, and Long-Word Read Cycle Flowchart

Clock 1 (C1)

The read cycle starts in C1. During C1, the processor places valid values on the address bus and transfer attributes. For user and supervisor mode accesses, which the corresponding memory unit translates, the user-programmable attribute signals (UPAx) are driven with the values from the matching user bits (U1 and U0). The transfer type (TTx) and transfer modifier (TMx) signals identify the specific access type. The read/write (R/W) signal is driven high for a read cycle. Cache inhibit out (\overline{CIOUT}) is asserted since the access is identified as noncacheable. Refer to **Section 4 Memory Management Unit** for information on the MC68060 and MC68LC060 memory units and **Appendix B MC68EC060** for information on the MC68EC060 memory unit.

Bus Operation



NOTE: It is assumed that the acknowledge termination ignore state capability is disabled.

Figure 7-13. Byte, Word, and Long-Word Read Bus Cycle Timing

The processor asserts transfer start (\overline{TS}) during C1 to indicate the beginning of a bus cycle. If not already asserted from a previous bus cycle, the transfer in progress (\overline{TIP}) signal is also asserted at this time to indicate that a bus cycle is active.

Clock 2 (C2)

During C2, the processor negates \overline{TS} . The selected peripheral device uses R/\overline{W} , $SIZ1$, $SIZ0$, $A1$, and $A0$ or \overline{BSx} to place its information on the data bus. With the exception of the R/\overline{W} signal, these signals also select any or all of the operand bytes ($D31$ – $D24$, $D23$ – $D16$, $D15$ – $D8$, and $D7$ – $D0$). If the first clock after C1 is not a wait state (CW), then the selected peripheral device asserts the transfer acknowledge (\overline{TA}) signal.

The MC68060 implements a special mode called the acknowledge termination ignore state capability to aid in high-frequency designs. In this mode, the processor begins sampling termination signals such as \overline{TA} after a user-programmed number of BCLK rising edges has expired. The \overline{SAS} signal is provided as a status output to indicate which BCLK rising edge the processor begins to sample the termination signals. If this mode is disabled, \overline{SAS} is asserted during C2 to indicate that the processor immediately begins sampling the termination signals. Refer to **7.14.1 Acknowledge Termination Ignore State Capability** for details on this special mode.

Assuming that the acknowledge termination ignore state capability is disabled, at the end of the first clock cycle C2, the processor samples the level of \overline{TA} and if asserted, registers the current value on the data bus; the bus cycle terminates, and the data is passed to the processor's appropriate memory unit. If \overline{TA} is not recognized asserted at the end of the clock cycle, the processor ignores the data and inserts a wait state instead of terminating the transfer. The processor continues to sample \overline{TA} on successive rising edges of BCLK until \overline{TA} is recognized asserted. Only when \overline{TA} is recognized asserted is data passed to the processor's appropriate memory unit.

When the processor recognizes \overline{TA} at the end of a clock cycle and terminates the bus cycle, \overline{TIP} remains asserted if the processor is ready to begin another bus cycle. Otherwise, the processor negates \overline{TIP} during the next clock.

7.7.2 Line Read Transfer

The processor uses line read transfers to access a 16-byte operand for a MOVE16 instruction and to support cache line filling. A line read accesses a block of four long words, aligned to a 16-byte memory boundary, by supplying a starting address that points to one of the long words and requires the memory device to sequentially drive each long word on the data bus. The selected device must internally increment $A3$ and $A2$ of the supplied address for each transfer, causing the address to wrap around at the end of the block if \overline{CLA} is not used. Otherwise, the external device may request the processor to increment $A3$ and $A2$ in a circular wrap-around fashion via the \overline{CLA} input. Refer to **7.7.7 Using CLA to Increment A3 and A2** for details on \overline{CLA} operation. The address and transfer attributes supplied by the processor remain stable during the transfers, and the selected device terminates each transfer by driving the long word on the data bus and asserting \overline{TA} . A line transfer performed in this manner with a single address is referred to as a line burst transfer.

The MC68060 supports burst-inhibited line transfers for memory devices that are unable to support bursting. For this type of bus cycle, the selected device supplies the first long word pointed to by the processor address and asserts transfer burst inhibit (\overline{TBI}) with \overline{TA} for the first transfer of the line access. The processor responds by terminating the line burst transfer and accessing the remainder of the line, using three long-word read bus cycles. Although the selected device can then treat the line bus cycle as four, independent, long-word bus

Bus Operation

cycles, the bus controller still treats the four transfers as a single line bus cycle and does not allow other unrelated processor accesses or bus arbitration to intervene between the transfers. \overline{TBI} is ignored after the first long-word transfer.

Line reads to support cache line filling can be cache inhibited by asserting transfer cache inhibit (\overline{TCI}) with \overline{TA} for the first long-word transfer of the line. The assertion of \overline{TCI} does not affect completion of the line transfer, but the bus controller registers and passes it to the memory controller for use. \overline{TCI} is ignored after the first long-word transfer of a line burst bus cycle and during the three long-word bus cycles of a burst-inhibited line transfer.

The address placed on the address bus by the processor for line bus cycle does not necessarily point to the most significant byte of each long word because A1 and A0 are copied from the original operand address supplied to the memory unit by the integer unit for line reads. These two bits are also unchanged for the three long-word bus cycles of a burst-inhibited line transfer. The selected device should ignore A1 and A0 for long-word and line read transfers.

7

The address of an instruction fetch will always be aligned to a long-word boundary (\$xxxxxxx0, \$xxxxxxx4, \$xxxxxxx8, or \$xxxxxxxC). This is unlike the MC68040 in which the prefetches occur on half-line boundaries. Therefore, compilers should attempt to locate branch targets on long-word boundaries to minimize branch stalls. For example, if the target of a branch is an instruction that starts at \$1000000E, the following burst sequence will occur upon a cache miss: \$1000000C, \$10000000, \$10000004, then \$10000008. Figure 7-14 and Figure 7-15 illustrate a flowchart and functional timing diagram for a line read bus transfer.

Clock 1 (C1)

The line read cycle starts in C1. During C1, the processor places valid values on the address bus and transfer attributes. For user and supervisor mode accesses that are translated by the corresponding memory unit, the UPx signals are driven with the values from the matching U1 and U0 bits. The TTx and TMx signals identify the specific access type. The R/\overline{W} signal is driven high for a read cycle, and the size signals (SIZx) indicate line size. \overline{CIOUT} is asserted for a MOVE16 operand read if the access is identified as non-cacheable. Refer to **Section 4 Memory Management Unit** for information on the MC68060 and MC68LC060 memory units and **Appendix B MC68EC060** for information on the MC68EC060 memory unit.

The processor asserts \overline{TS} during C1 to indicate the beginning of a bus cycle. If not already asserted from a previous bus cycle, \overline{TIP} is also asserted at this time to indicate that a bus cycle is active.

Clock 2 (C2)

During C2, the processor negates \overline{TS} . The selected device uses R/\overline{W} and SIZx to place the data on the data bus. (The first transfer must supply the long word at the corresponding long-word boundary.) Concurrently, the selected device asserts \overline{TA} and either negates \overline{TBI} to indicate it can or asserts \overline{TBI} to indicate it cannot support a burst transfer.

The MC68060 implements a special mode called the acknowledge termination ignore state capability to aid in high-frequency designs. In this mode, the processor begins sampling termination signals such as \overline{TA} after a user-programmed number of BCLK rising

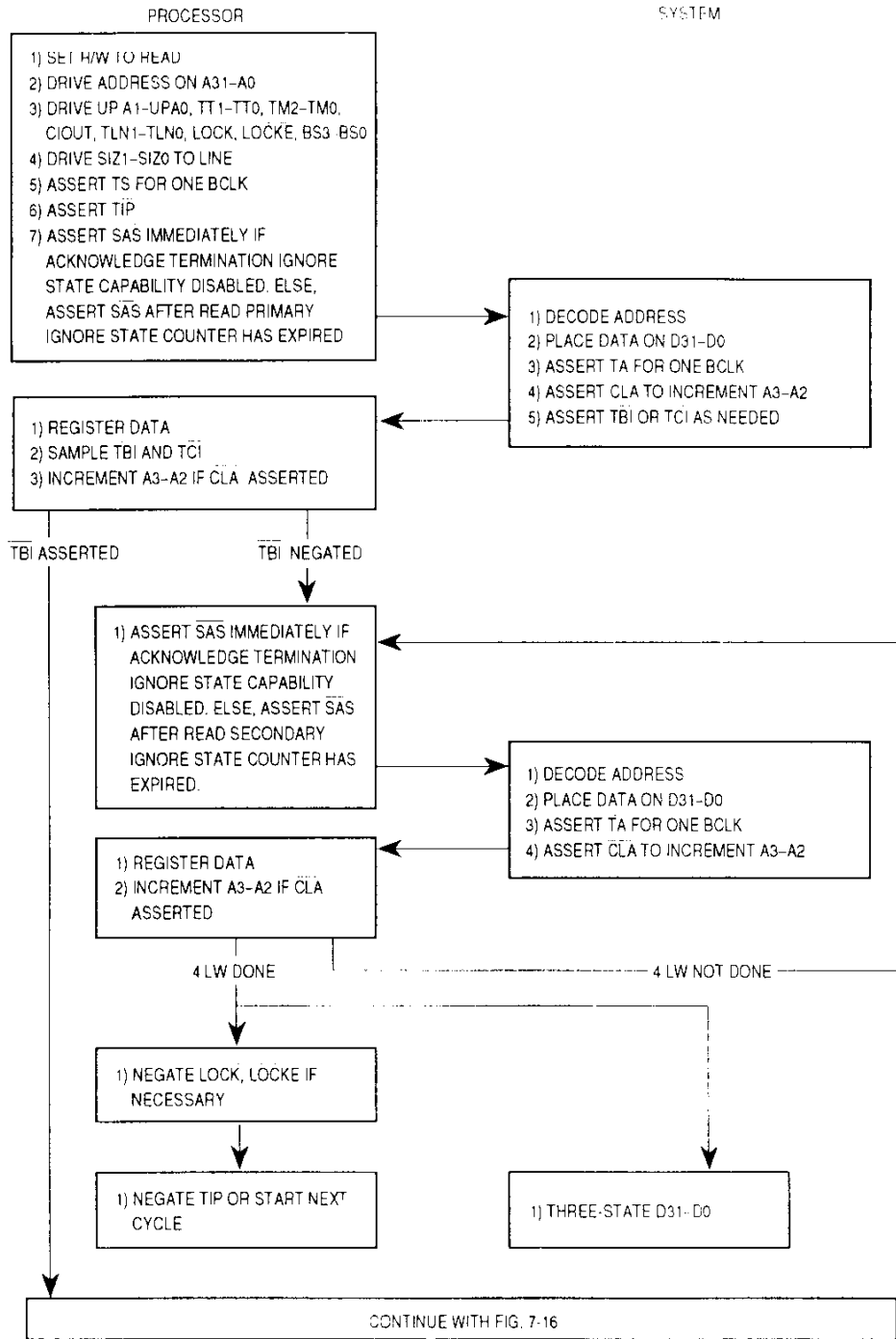
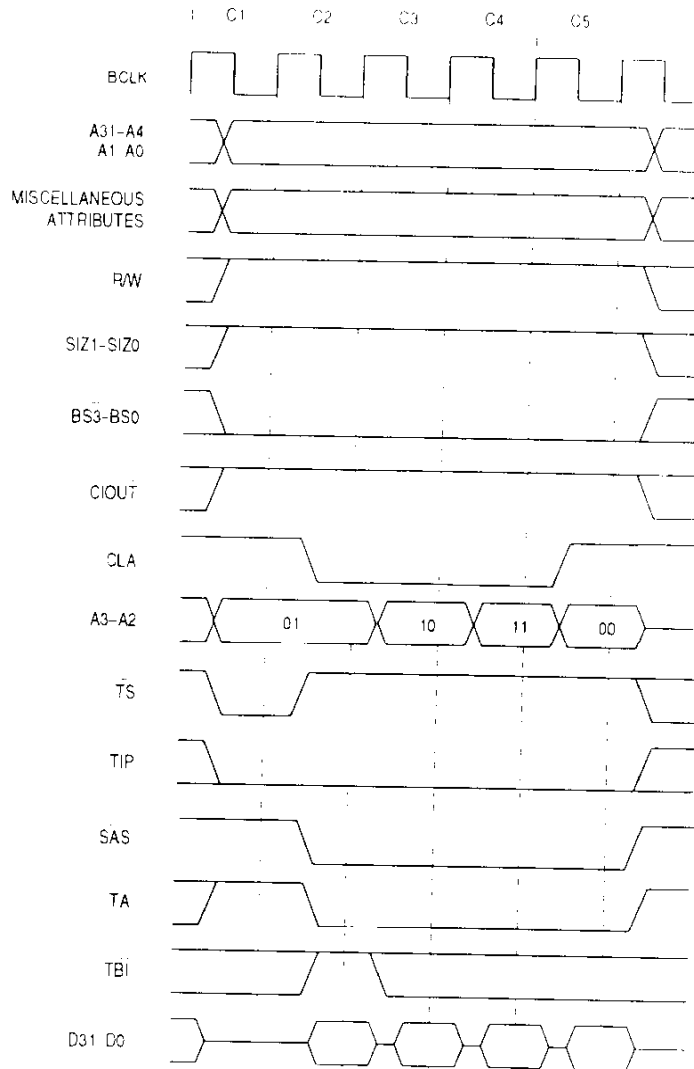

Figure 7-14. Line Read Cycle Flowchart

edges has expired. The signal \overline{SAS} is provided as a status output to indicate which BCLK rising edge the processor begins to sample the termination signals. If this mode is dis-

Bus Operation



NOTE: It is assumed that the acknowledge termination ignore state capability is disabled

Figure 7-15. Line Read Transfer Timing

abled, \overline{SAS} is asserted during C2 to indicate that the processor immediately begins sampling the terminations signals. Refer to 7.14.1 **Acknowledge Termination Ignore State Capability** for details on this special mode.

Assuming that the acknowledge termination ignore state capability is disabled, the processor samples the level of \overline{TA} , \overline{TBI} , and \overline{TCI} and registers the current value on the data bus at the end of C2. If \overline{TA} is asserted, the transfer terminates and the data is passed to the appropriate memory unit. If \overline{TA} is not recognized asserted, the processor ignores the data and inserts wait states instead of terminating the transfer. The processor continues to sample \overline{TA} , \overline{TBI} , and \overline{TCI} on successive rising edges of BCLK until \overline{TA} is recognized

asserted. The registered data and the value of $\overline{\text{TCI}}$ are then passed to the appropriate memory unit.

If $\overline{\text{TBI}}$ was negated with the assertion of $\overline{\text{TA}}$, the processor continues the cycle with C3. Otherwise, if $\overline{\text{TBI}}$ was asserted, the line transfer is burst inhibited, and the processor reads the remaining three long words using long-word read bus cycles. The processor increments A3 and A2 for each read, and the new address is placed on the address bus for each bus cycle. Refer to **7.7.1 Byte, Word, and Long-Word Read Transfer Cycles** for information on long-word reads. If no wait states are generated, a burst-inhibited line read completes in eight clocks instead of the five required for a burst read.

Clock 3 (C3)

The processor holds the address and transfer attribute signals constant during C3 if $\overline{\text{CLA}}$ is negated. The selected device must either increment A3 and A2 to reference the next long word to transfer, place the data on the data bus, and assert $\overline{\text{TA}}$, or alternatively assert the $\overline{\text{CLA}}$ input to request the processor to increment A3 and A2. Refer to **7.7.7 Using CLA to Increment A3 and A2** for details on $\overline{\text{CLA}}$ operation.

As in the description of C2, using acknowledge termination ignore state capability, the processor ignores any termination signal, such as $\overline{\text{TA}}$, until a user-programmable number of BCLK edges has expired. And, as in the description in C2, $\overline{\text{SAS}}$ indicates the first BCLK rising edge in which acknowledge termination signals become significant. If this mode is disabled, $\overline{\text{SAS}}$ stays asserted in C3 to indicate that the processor will sample $\overline{\text{TA}}$ immediately. Refer to **7.14.1 Acknowledge Termination Ignore State Capability** for details on this mode.

Assuming that the acknowledge termination ignore state capability is disabled, the processor samples the level of $\overline{\text{TA}}$ and registers the current value on the data bus at the end of C3. If $\overline{\text{TA}}$ is asserted, the transfer terminates and the second long word of data is passed to the appropriate memory unit. If $\overline{\text{TA}}$ is not recognized asserted at the end of C3, the processor ignores the latched data and inserts wait states instead of terminating the transfer. The processor continues to sample $\overline{\text{TA}}$ on successive rising edges of BCLK until it is recognized asserted. The registered data is then passed to the appropriate memory unit.

Clock 4 (C4)

This clock is identical to C3 except that once $\overline{\text{TA}}$ is recognized asserted, the registered value corresponds to the third long word of data for the burst.

Clock 5 (C5)

This clock is identical to C3 except that once $\overline{\text{TA}}$ is recognized, the registered value corresponds to the fourth long word of data for the burst. After the processor recognizes the last $\overline{\text{TA}}$ assertion and terminates the line read bus cycle, $\overline{\text{TIP}}$ remains asserted if the processor is ready to begin another bus cycle. Otherwise, the processor negates $\overline{\text{TIP}}$ during the next clock.

Figure 7-16 and Figure 7-17 illustrate a flowchart and functional timing diagram for a burst-inhibited line read bus cycle.

Bus Operation

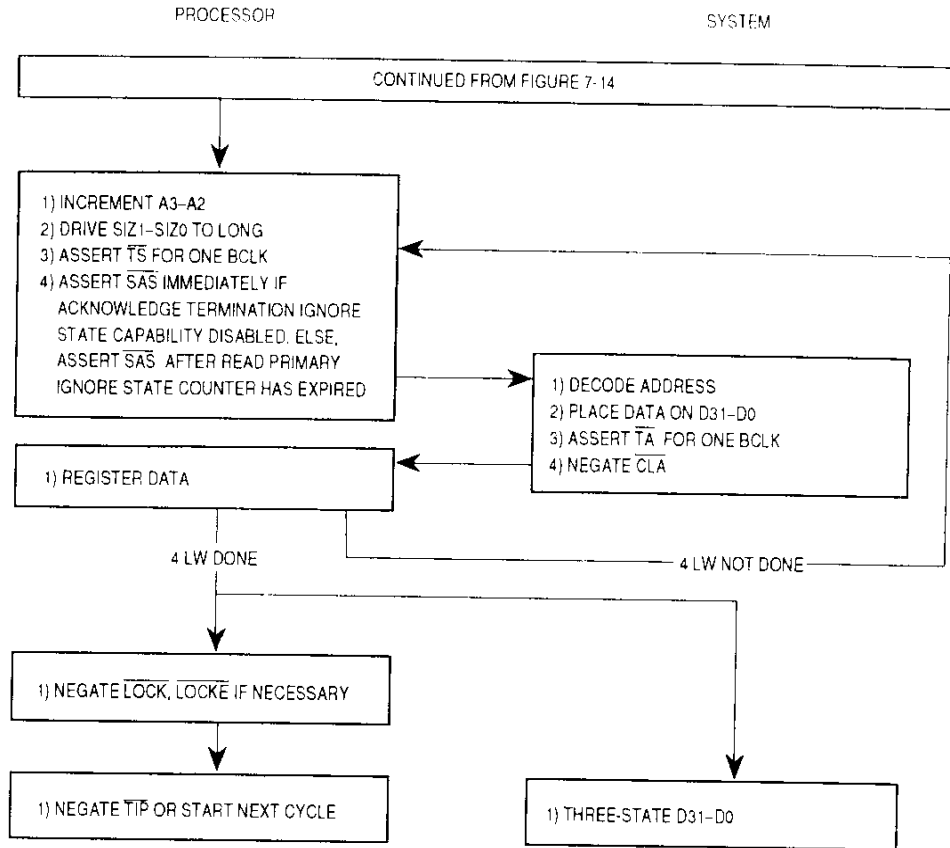

Figure 7-16. Burst-Inhibited Line Read Cycle Flowchart

7.7.3 Byte, Word, and Long-Word Write Cycles

During a write transfer, the processor transfers data to a memory or peripheral device. The level on the \overline{TCl} signal is ignored by the processor during all write cycles. The bus controller performs byte, word, and long-word write transfers for the following cases:

- Accesses to a disabled cache
- Accesses to a memory page that is specified noncacheable
- Accesses that are implicitly noncacheable (locked read-modify-write accesses, accesses to an alternate logical address space via the MOVES instruction, and table searches)
- Writes to writethrough pages
- Accesses that do not allocate in the data cache on a write miss (exception stacking)
- The first transfer of a line write is terminated with \overline{TBI} , forcing completion of the line access using three additional long-word write transfers
- Cache line pushes for lines containing a single dirty long word.

Figure 7-18 and Figure 7-19 illustrate a flowchart and functional timing diagram for byte, word, and long-word write bus transfers.

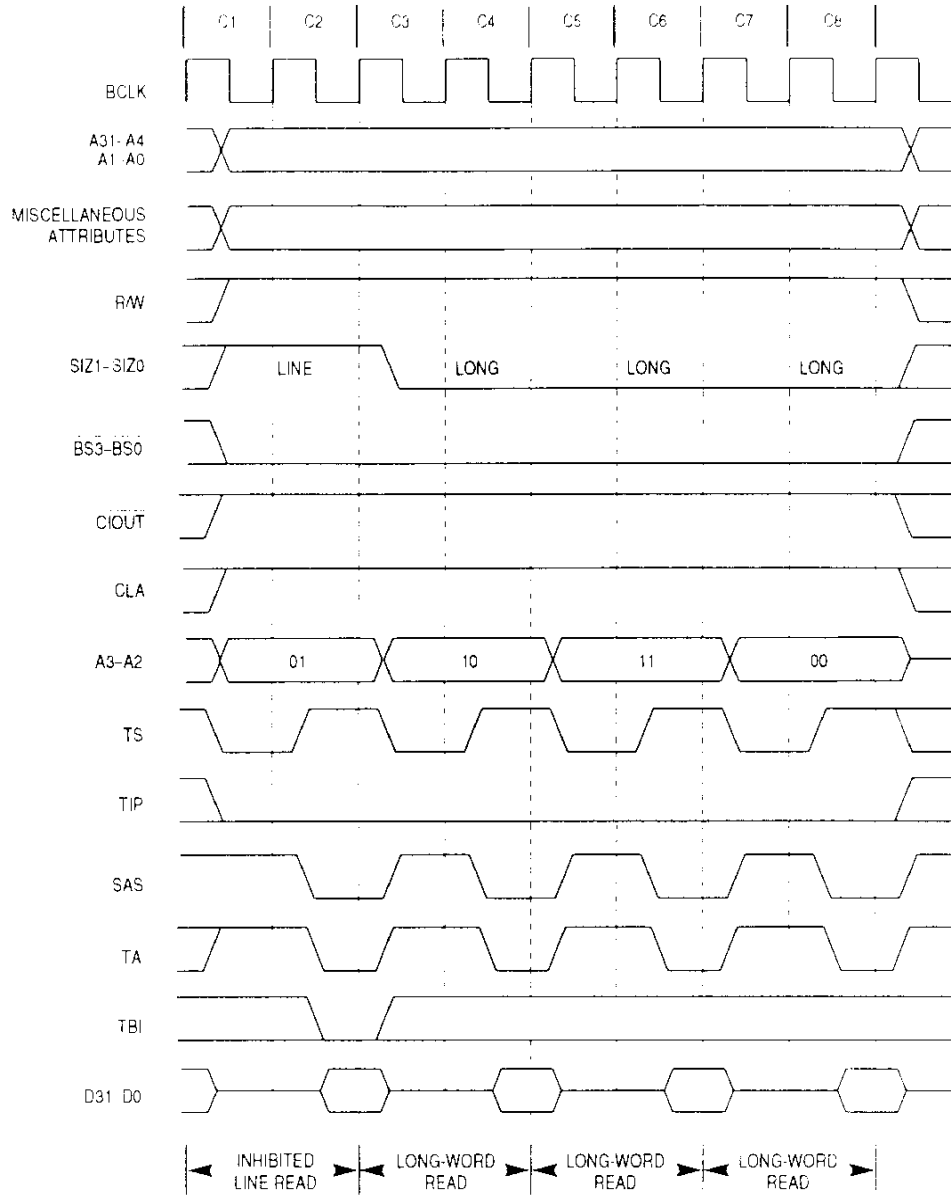

NOTE: It is assumed that the acknowledge termination ignore state capability is disabled

Figure 7-17. Burst-Inhibited Line Read Bus Cycle Timing

Bus Operation

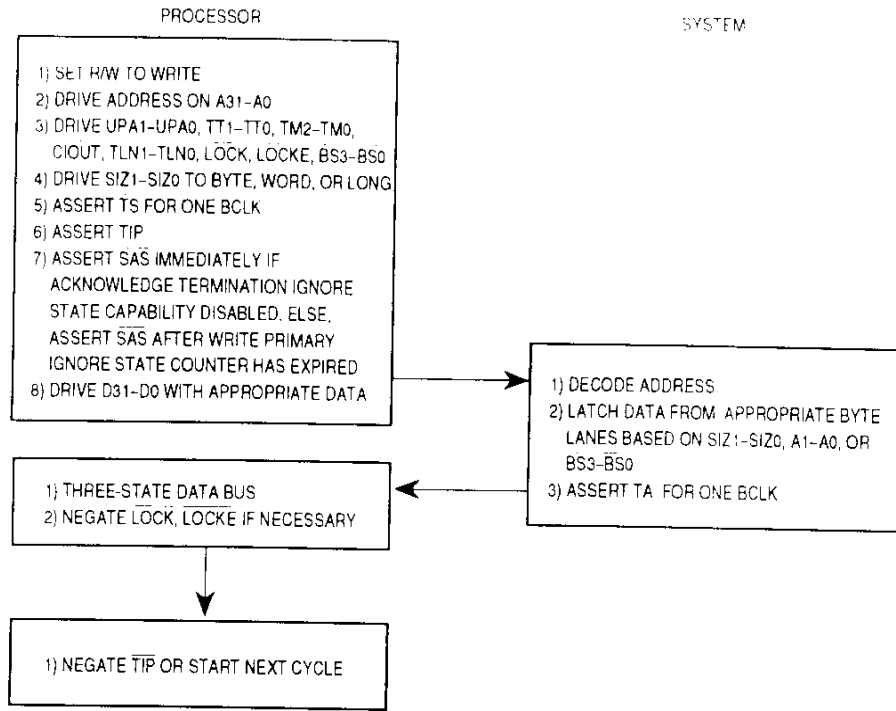
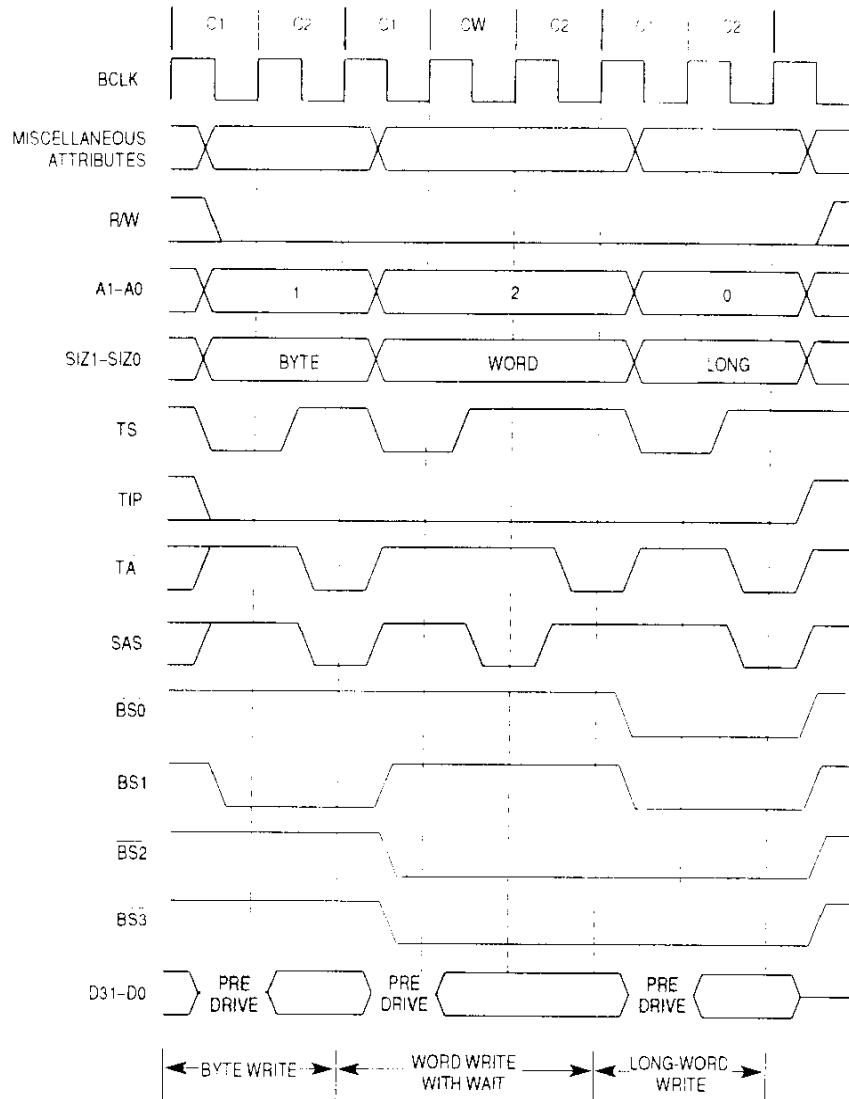

Figure 7-18. Byte, Word, and Long-Word Write Transfer Flowchart



NOTE: It is assumed that the acknowledge termination ignore state capability is disabled.

Figure 7-19. Long-Word Write Bus Cycle Timing

Bus Operation

Clock 1 (C1)

The write cycle starts in C1. During C1, the processor places valid values on the address bus and transfer attributes. The processor asserts \overline{TS} during C1 to indicate the beginning of a bus cycle. If not already asserted from a previous bus cycle, the \overline{TIP} signal is also asserted at this time to indicate that a bus cycle is active.

The processor pre-conditions the data bus during C1 to improve AC timing. The process of pre-conditioning involves reinforcing the logic level that is already at the data pin. If the voltage level is originally zero volts, nothing is done; if the voltage level is 3.3 V, that voltage level is reinforced; however, if the voltage level is originally 5 V, the processor drives that data pin from 5 V down to 3.3 V. Note that no active logic change is done at this time. The actual logic level change is done in C2. This pre-conditioning affects operation primarily when using the processor in a 5-V system.

For user and supervisor mode accesses, which the corresponding memory unit translates, the UPx signals are driven with the values from the U1 and U0 bits for the area. The TTx and TMx signals identify the specific access type. The R/\overline{W} signal is driven low for a write cycle. \overline{CIOUT} is asserted if the access is identified as noncachable or if the access references an alternate address space. Refer to **Section 4 Memory Management Unit** for information on the MC68060 and MC68LC060 memory units and **Appendix B MC68EC060** for information on the MC68EC060 memory unit.

Clock 2 (C2)

During C2, the processor negates \overline{TS} and drives the appropriate bytes of the data bus with the data to be written. All other bytes are driven with undefined values. The selected device uses R/\overline{W} , SIZ1, SIZ0, A1, A0, or $\overline{BS3-BS0}$, and \overline{CIOUT} to register only the required information from the data bus. With the exception of R/\overline{W} and \overline{CIOUT} , these signals also select any or all of the bytes (D31–D24, D23–D16, D15–D8, and D7–D0). If C2 is not a wait state (CW), then the selected peripheral device asserts the \overline{TA} signal.

The MC68060 implements a special mode called the acknowledge termination ignore state capability to aid in high-frequency designs. In this mode, the processor begins the sampling of termination signals such as \overline{TA} after a user-programmed number of BCLK rising edges has expired. The \overline{SAS} signal is provided as a status output to indicate which BCLK rising edge the processor begins to sample the termination signals. If this mode is disabled, \overline{SAS} is asserted during C2 to indicate that the processor immediately begins sampling the terminations signals. Refer to **7.14.1 Acknowledge Termination Ignore State Capability** for details on this special mode.

Assuming that the acknowledge termination ignore state capability is disabled, at the end of the C2, the processor samples the level of \overline{TA} , terminating the bus cycle if \overline{TA} is asserted. If \overline{TA} is not recognized asserted at the end of the clock cycle, the processor ignores the data and inserts a wait state instead of terminating the transfer. The processor continues to sample \overline{TA} on successive rising edges of BCLK until \overline{TA} is recognized asserted. The data bus then three-states and the bus cycle ends.

When the processor recognizes \overline{TA} at the rising BCLK edge and terminates the bus cycle, \overline{TIP} remains asserted if the processor is ready to begin another bus cycle. Otherwise, the

processor negates \overline{TP} during the next clock. The processor also three-states the data bus during the next clock following termination of the write transfer.

7.7.4 Line Write Cycles

The processor uses line write bus cycles to access a 16-byte operand for a MOVE16 instruction and to support cache line pushes. Both burst and burst-inhibited transfers are supported. Figure 7-20 and Figure 7-22 illustrate a flowchart and functional timing diagram for a line write bus cycle.

Clock 1 (C1)

The line write cycle starts in C1. During C1, the processor places valid values on the address bus and transfer attributes. The processor asserts \overline{TS} during C1 to indicate the beginning of a bus cycle. If not already asserted from a previous bus cycle, the \overline{TP} signal is also asserted at this time to indicate that a bus cycle is active.

The processor pre-conditions the data bus during C1 to improve AC timing. The process of pre-conditioning involves reinforcing the logic level that is already at the data pin. If the voltage level is originally zero volts, nothing is done; if the voltage level is 3.3 V, that voltage level is reinforced; however, if the voltage level is originally 5 V, the processor drives that data pin from 5 V down to 3.3 V. Note that no active logic change is done at this time. The actual logic level change is done in C2. This pre-conditioning affects operation primarily when using the processor in a 5-V system.

For user and supervisor mode accesses that are translated by the corresponding memory unit, UPAX signals are driven with the values from the matching U1 and U0 bits. The TTx and TMx signals identify the specific access type. The R/W signal is driven low for a write cycle, and the SIZx signals indicate line size. Refer to **Section 4 Memory Management Unit** for information on the MC68060 and MC68LC060 memory units and **Appendix B MC68EC060** for information on the MC68EC060 memory unit.

Clock 2 (C2)

During C2, the processor negates \overline{TS} and drives the data bus with the data to be written. The selected device uses R/W, SIZ1, SIZ0, or \overline{BSx} to register the data on the data bus. Concurrently, the selected device asserts \overline{TA} and either negates \overline{TBI} to indicate it can or asserts \overline{TBI} to indicate it cannot support a burst transfer.

The MC68060 implements a special mode called the acknowledge termination ignore state capability to aid in high-frequency designs. In this mode, the processor begins sampling termination signals such as \overline{TA} after a user-programmed number of BCLK rising edges has expired. The \overline{SAS} signal is provided as a status output to indicate which BCLK rising edge the processor begins to sample the termination signals. If this mode is disabled, \overline{SAS} is asserted during C2 to indicate that the processor immediately begins sampling the terminations signals. Refer to **7.14.1 Acknowledge Termination Ignore State Capability** for details on this special mode.

Assuming that the acknowledge termination ignore state capability is disabled, the processor samples the level of \overline{TA} and \overline{TBI} at end of C2. If \overline{TA} is asserted, the transfer terminates. If \overline{TA} is not recognized asserted, the processor inserts wait states instead of terminating the transfer. The processor continues to sample \overline{TA} and \overline{TBI} on successive rising edges of BCLK until \overline{TA} is recognized asserted. If \overline{TBI} was negated with the asser-

Bus Operation

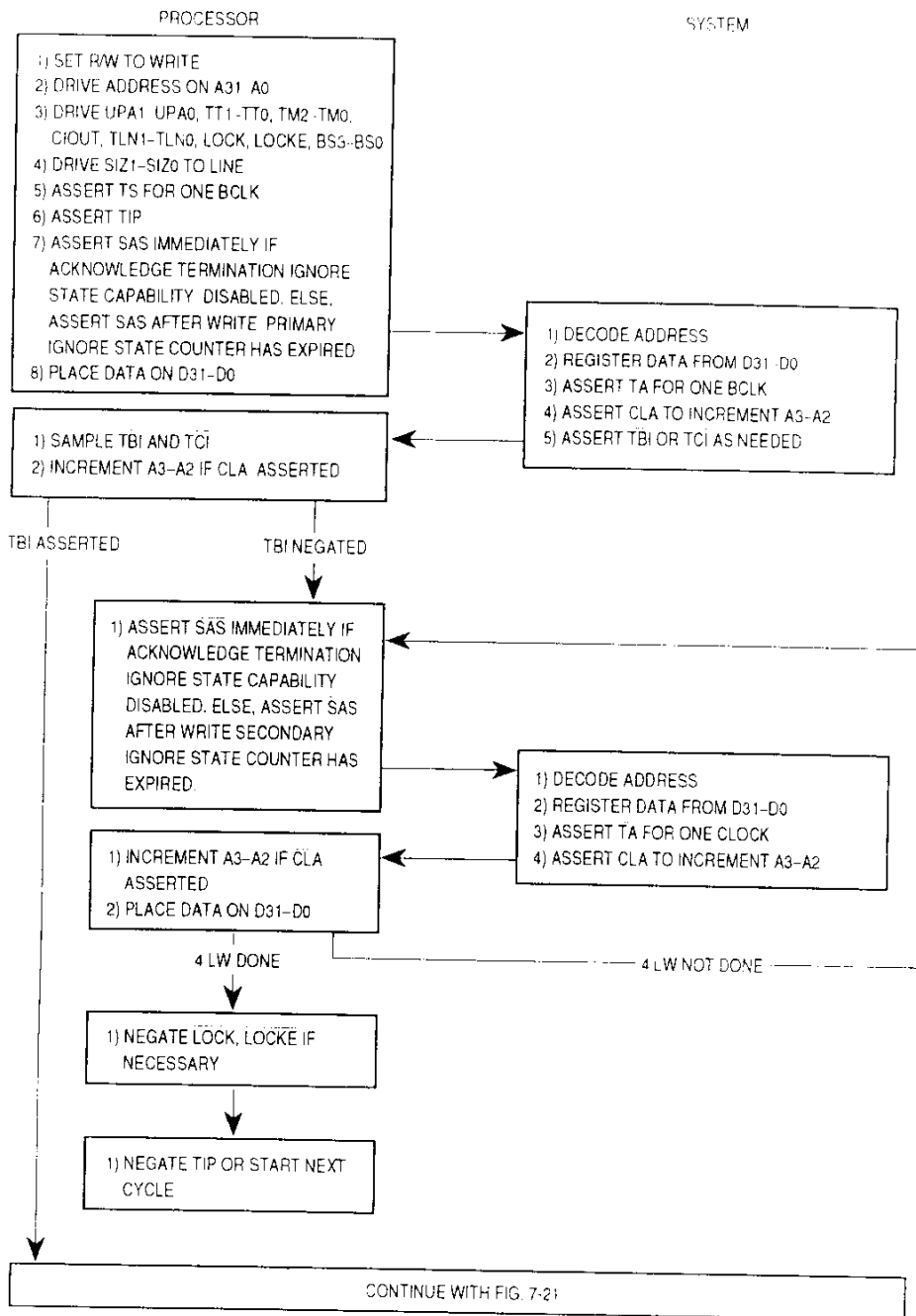

Figure 7-20. Line Write Cycle Flowchart

tion of \overline{TA} , the processor continues the cycle with C3. Otherwise, if \overline{TBI} was asserted, the line transfer is burst inhibited and the processor writes the remaining three long words using long-word write bus cycles. In this case, the processor increments A3 and A2 for each write, and the new address is placed on the address bus for each bus cycle. Refer to **7.7.3 Byte, Word, and Long-Word Write Cycles** for information on long-word writes. If no wait

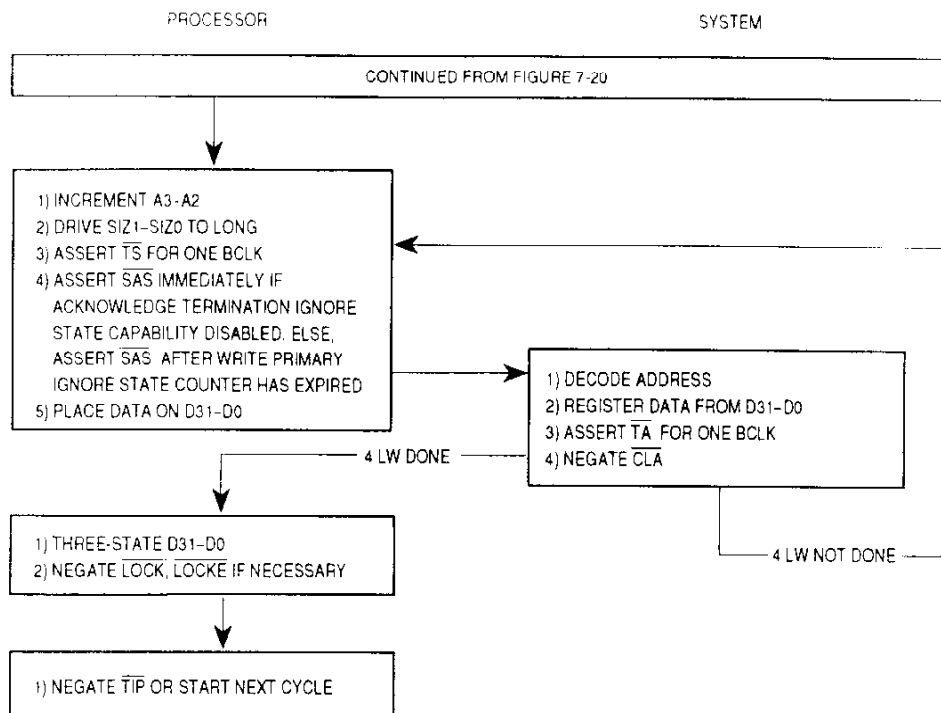

Figure 7-21. Line Write Burst-Inhibited Cycle Flowchart

states are generated, a burst-inhibited line write completes in eight clocks instead of the five required for a burst write.

Clock 3 (C3)

The processor drives the second long word of data on the data bus and holds the address and transfer attribute signals constant during C3. The selected device either increments A3 and A2 to reference the next long word, or requests the processor to increment A3 and A2 via the \overline{CLA} input.

The selected device then registers this data from the data bus and asserts \overline{TA} . At the end of C3, assuming the acknowledge termination ignore state capability is disabled, the processor samples the level of \overline{TA} ; if \overline{TA} is asserted, the transfer terminates.

If \overline{TA} is not recognized asserted at the end of C3, the processor inserts wait states instead of terminating the transfer. The processor continues to sample \overline{TA} on successive rising edges of BCLK until \overline{TA} is recognized asserted.

Clock 4 (C4)

This clock is identical to C3 except that the value driven on the data bus corresponds to the third long word of data for the burst.

Clock 5 (C5)

This clock is identical to C3 except that the value driven on the data bus corresponds to the fourth long word of data for the burst. After the processor recognizes the last \overline{TA} as-



Bus Operation

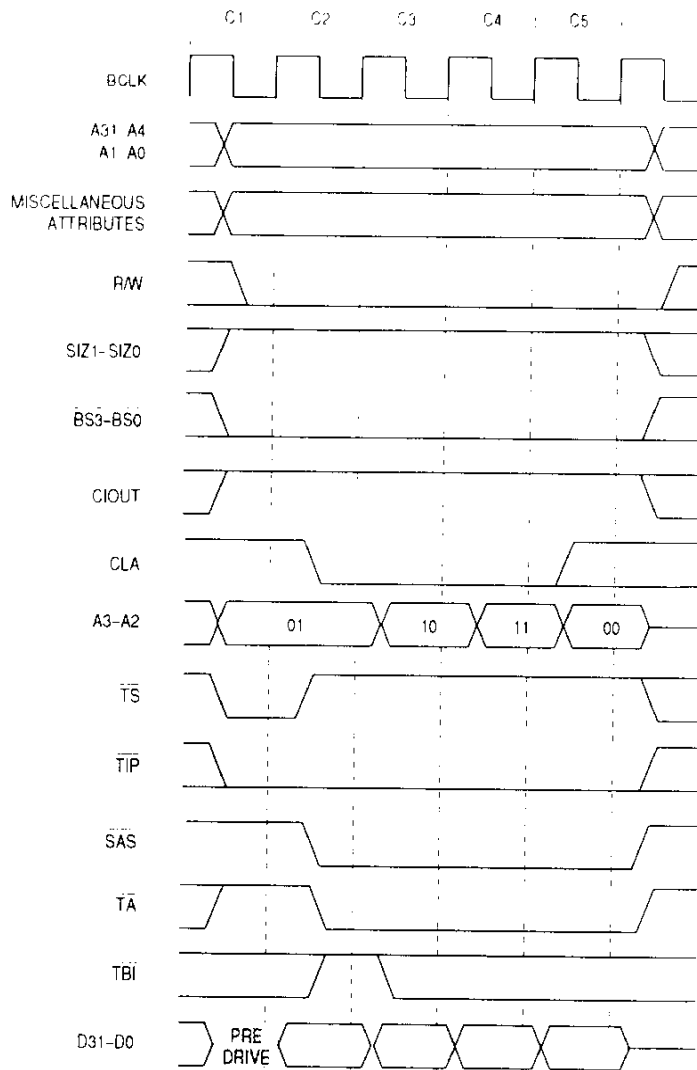

NOTE: It is assumed that the acknowledge termination ignore state capability is disabled.

Figure 7-22. Line Write Bus Cycle Timing

sertion and terminates the line write bus cycle, \overline{TIP} remains asserted if the processor is ready to begin another bus cycle. Otherwise, the processor negates \overline{TIP} during the next clock. The processor also three-states the data bus during the next clock following termination of the write cycle.

7.7.5 Locked Read-Modify-Write Cycles

The locked read-modify-write sequence performs a read, conditionally modifies the data in the processor, and writes the data out to memory. In the MC68060, this operation can be indivisible, providing semaphore capabilities for multiprocessor systems. During the entire

read-modify-write sequence, the MC68060 asserts the $\overline{\text{LOCK}}$ signal to indicate that an indivisible operation is occurring and asserts the $\overline{\text{LOCKE}}$ signal for the last write bus cycle to indicate completion of the locked sequence. In addition to $\overline{\text{LOCK}}$ and $\overline{\text{LOCKE}}$, the MC68060 provides the $\overline{\text{BGR}}$ input to allow external arbiters to indicate to the processor whether or not to break a locked sequence. Refer to **7.11 Bus Arbitration** for details on the bus arbitration protocol.

The external arbiter can use the $\overline{\text{LOCK}}$, $\overline{\text{LOCKE}}$, and/or $\overline{\text{BGR}}$ to prevent arbitration of the bus during locked processor sequences. External bus arbitrations can use $\overline{\text{LOCKE}}$ to support bus arbitration between consecutive read-modify-write cycles. A read-modify-write operation is treated as noncachable. If the access hits in the data cache, it invalidates a matching valid entry and pushes a matching dirty entry. The read-modify-write transfer begins after the line push (if required) is complete; however, $\overline{\text{LOCK}}$ may assert during the line push bus cycle.

The TAS, CAS, and MOVEC of BUSCR instructions are the only MC68060 instructions that utilize read-modify-write transfers. Some page descriptor updates during translation table searches also use read-modify-write transfers. Refer to **Section 4 Memory Management Unit** for information about table searches.

The read-modify-write transfer for the CAS instruction in the MC68060 is similar to that of the MC68040. If an operand does not match one of these instructions, the MC68060 executes a single write transfer to terminate the locked sequence with $\overline{\text{LOCKE}}$ asserted. For the CAS instruction, the value read from memory is written back. Figure 7-23 illustrates a functional timing diagram for a TAS instruction read-modify-write bus transfer.

Clock 1 (C1)

The read cycle starts in C1. During C1, the processor places valid values on the address bus and transfer attributes. $\overline{\text{LOCK}}$ is asserted to identify a locked read-modify-write bus cycle. For user and supervisor mode accesses, which the corresponding memory unit translates, the UPAX signals are driven with the values from the matching U1 and U0 bits. The $\overline{\text{TTx}}$ and $\overline{\text{TMx}}$ signals identify the specific access type. $\overline{\text{R/W}}$ is driven high for a read cycle. $\overline{\text{C1OUT}}$ is asserted if the access is identified as noncachable. The processor asserts $\overline{\text{TS}}$ during C1 to indicate the beginning of a bus cycle. If not already asserted from a previous bus cycle, the $\overline{\text{TIP}}$ signal is also asserted at this time to indicate that a bus cycle is active. Refer to **Section 4 Memory Management Unit** for information on the MC68060 and MC68LC060 memory units and **Appendix B MC68EC060** for information on the MC68EC060 memory unit.

Clock 2 (C2)

During C2, the processor negates $\overline{\text{TS}}$. The selected device uses $\overline{\text{R/W}}$, SIZ1 , SIZ0 , A1 , and A0 or $\overline{\text{BSx}}$, to place its information on the data bus. With the exception of $\overline{\text{R/W}}$, these signals also select any or all of the data bus bytes (D24-D31 , D16-D23 , D15-D8 , and D7-D0).

Concurrently, the selected device asserts $\overline{\text{TA}}$. At the end of the C2, assuming that the acknowledge termination ignore state capability is disabled, the processor samples the level of $\overline{\text{TA}}$ and registers the current value on the data bus. If $\overline{\text{TA}}$ is asserted, the read transfer terminates and the registered data is passed to the appropriate memory unit. If $\overline{\text{TA}}$ is not

Bus Operation

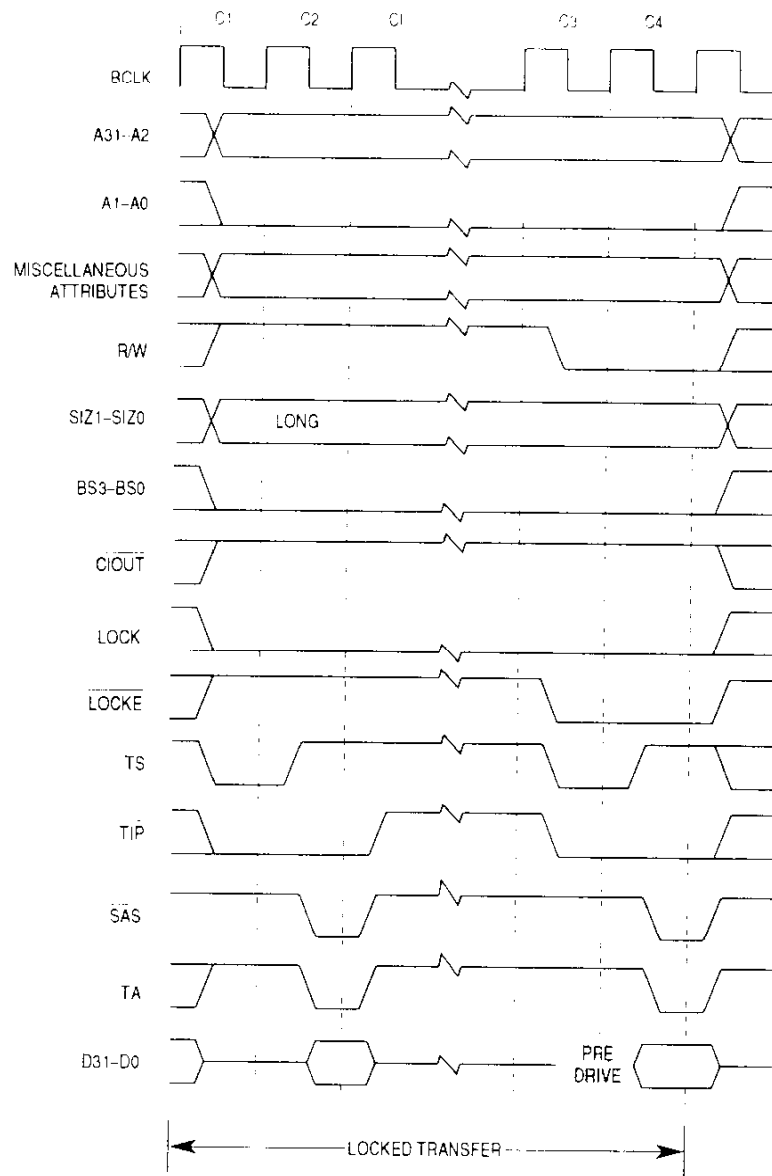

NOTE: It is assumed that the acknowledge termination ignore state capability is disabled.

Figure 7-23. Locked Bus Cycle for TAS Instruction Timing

recognized asserted, the processor ignores the data and appends a wait state instead of terminating the transfer. The processor continues to sample \overline{TA} on successive rising edges of BCLK until \overline{TA} is recognized as asserted. The registered data is then passed to the appropriate memory unit. If more than one read cycle is required to read in the operand(s), C1 and C2 are repeated accordingly.

When the processor recognizes \overline{TA} at the end of the last read transfer for the locked bus cycle, it negates \overline{TIP} during the first half of the next clock.

Clock Idle (C1)

The processor does not assert any new control signals during the idle clock states, but it may begin the modify portion of the sequence at this time. The R/\overline{W} signal remains in the read mode until C3 to prevent bus conflicts with the preceding read portion of the cycle and the data bus is not driven until C4.

Clock 3 (C3)

During C3, the processor places valid values on the address bus and transfer attributes and drives R/\overline{W} low for a write cycle. The processor asserts \overline{TS} to indicate the beginning of a bus cycle. The \overline{TIP} signal is also asserted at this time to indicate that a bus cycle is active. \overline{LOCKE} is asserted during C3 for the last write bus cycle of the locked sequence. If multiple write transfers are required for misaligned operands or multiple operands, \overline{LOCKE} is asserted only for the final write transfer.

The processor pre-conditions the data bus during C3 to improve AC timing. The process of pre-conditioning involves reinforcing the logic level that is already at the data pin. If the voltage level is originally zero volts, nothing is done; if the voltage level is 3.3 V, that voltage level is reinforced; however, if the voltage level is originally 5 V, the processor drives that data pin from 5 V down to 3.3 V. Note that no active logic change is done at this time. The actual logic level change is done in C4. This pre-conditioning affects operation primarily when using the processor in a 5-V system.

Clock 4 (C4)

During C4, the processor negates \overline{TS} and drives the appropriate bytes of the data bus with the data to be written. All other bytes are driven with undefined values. The selected device uses R/\overline{W} , $SIZ1$, $SIZ0$, $A1$, and $A0$ or \overline{BSx} , to register the information on the data bus. Any or all of the data bus bytes ($D31-D24$, $D23-D16$, $D15-D8$, and $D7-D0$) are selected by $SIZ1$, $SIZ0$, $A1$, and $A0$ or \overline{BSx} . Concurrently, the selected device asserts \overline{TA} . Assuming that the acknowledge termination ignore state capability is disabled, the processor samples the level of \overline{TA} ; if \overline{TA} is asserted, the bus cycle terminates. If \overline{TA} is not recognized asserted at the end of C4, the processor appends a wait state instead of terminating the transfer. The processor continues to sample the \overline{TA} signal on successive rising edges of BCLK until it is recognized asserted.

When the processor recognizes \overline{TA} at the rising edge of BCLK, the bus cycle is terminated, but \overline{TIP} remains asserted if the processor is ready to begin another bus cycle. Otherwise, the processor negates \overline{TIP} during the next clock. The processor also three-states the data bus during the next clock following termination of the write cycle. When the last write transfer is terminated, \overline{LOCKE} is negated. The processor also negates \overline{LOCK} if the next bus cycle is not a read-modify-write operation.

7.7.6 Emulating CAS2 and CAS Misaligned

The CAS2 and CAS (with misaligned operands) are not supported in hardware by the MC68060. If these instructions are encountered, an unimplemented integer exception is taken. Once the opcode for a CAS2 or CAS is decoded, the MOVEC instruction to the

Bus Operation

BUSCR is used to control the $\overline{\text{LOCK}}$ and $\overline{\text{LOCKE}}$ outputs. Refer to **7.4 Bus Control Register** for the format of the BUSCR. Emulation of these instructions is done as part of the MC68060 software package (M68060SP). Refer to **Appendix C MC68060 Software Package** for more information.

7.7.7 Using $\overline{\text{CLA}}$ to Increment A3 and A2

The MC68060 provides the capability to cycle long-word address bits A3, A2 based on the $\overline{\text{CLA}}$ signal, which should assist in supporting high-speed DRAM systems. $\overline{\text{CLA}}$ may also be used to support bursting for slaves which do not burst.

The processor begins sampling $\overline{\text{CLA}}$ immediately following the BCLK rising edge that causes $\overline{\text{TS}}$ to assert. The initial address of the line transfer is that of the first requested or needed long word and the attributes are those of the line transfer. After each BCLK rising edge when $\overline{\text{CLA}}$ is asserted, the long-word address (A3, A2) increments in circular wrap-around fashion. If $\overline{\text{CLA}}$ is negated, A3, A2 does not change, but remains fixed, as on the MC68040 processor. Since $\overline{\text{CLA}}$ is not an acknowledge termination signal, it is not affected by the acknowledge termination ignore state capability, if that mode is enabled. Also note that the A3, A2 increments in a circular wrap around fashion for as many times as $\overline{\text{CLA}}$ is asserted about a rising BCLK edge.

Figure 7-24 shows how $\overline{\text{CLA}}$ may be used for a high-speed DRAM design. In this figure, the DRAM design requires a means of cycling A3, A2 before $\overline{\text{TA}}$ is asserted to the processor. $\overline{\text{CLA}}$ provides a method of avoiding a delay which would otherwise be incurred with the use of an external medium-scale integration (MSI) counter. W0 to W3 represent A3, A2 incrementing. C0 to C3 represent the column address sequencing caused by the change of A3, A2. The timing diagram represents a 5:3:3:3 design, which is feasible with a full-speed 50-MHz clock and 65-ns page-mode DRAMs.

7.8 ACKNOWLEDGE CYCLES

Bus transfers with transfer type signals TT1 and TT0 = \$3 are classified as acknowledge bus cycles. The following paragraphs describe interrupt acknowledge, breakpoint acknowledge, and LPSTOP broadcast bus cycles that use this encoding.

7.8.1 Interrupt Acknowledge Cycles

When a peripheral device requires the services of the MC68060 or is ready to send information that the processor requires, it can signal the processor to take an interrupt exception. The interrupt exception transfers control to a routine that responds appropriately. The peripheral device uses the interrupt priority level signals ($\overline{\text{IPLx}}$) to signal an interrupt condition to the processor and to specify the priority level for the condition. Refer to **Section 8 Exception Processing** for a discussion on the $\overline{\text{IPLx}}$ levels and $\overline{\text{IPEND}}$.

The status register (SR) of the MC68060 contains an interrupt priority mask (I2–I0 bits). The value in the interrupt mask is the highest priority level that the processor ignores. When an interrupt request has a priority higher than the value in the mask, the processor makes the request a pending interrupt. $\overline{\text{IPLx}}$ must maintain the interrupt request level until the MC68060 acknowledges the interrupt to guarantee that the interrupt is recognized. The MC68060 continuously samples $\overline{\text{IPLx}}$ on consecutive rising edges of CLK to synchronize

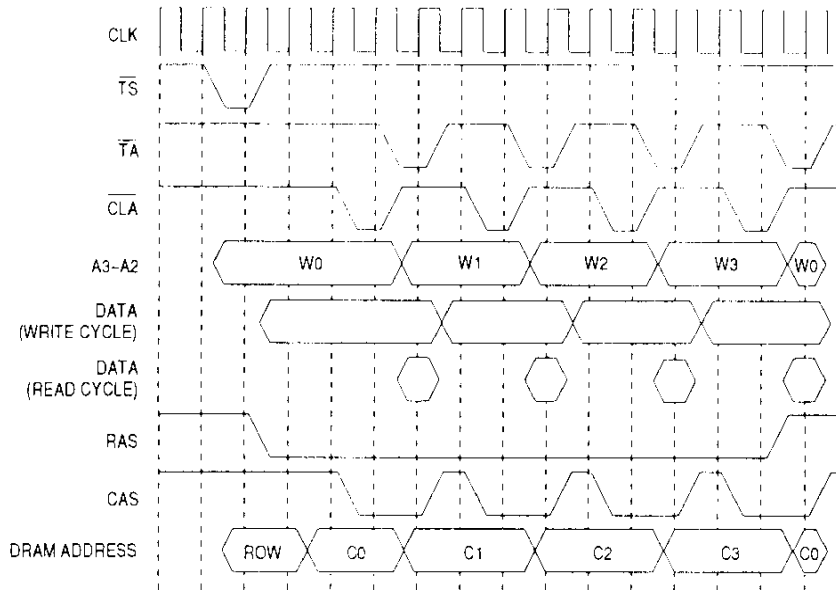

Figure 7-24. Using \overline{CLA} in a High-Speed DRAM Design

and debounce these signals. An interrupt request that is held constant for two consecutive CLK periods is considered a valid input. Although the protocol requires that the request remain until the processor runs an interrupt acknowledge cycle for that interrupt value, an interrupt request that is held for as short a period as two CLK cycles can be potentially recognized. Figure 7-25 is a flowchart of the procedure for a pending interrupt condition.

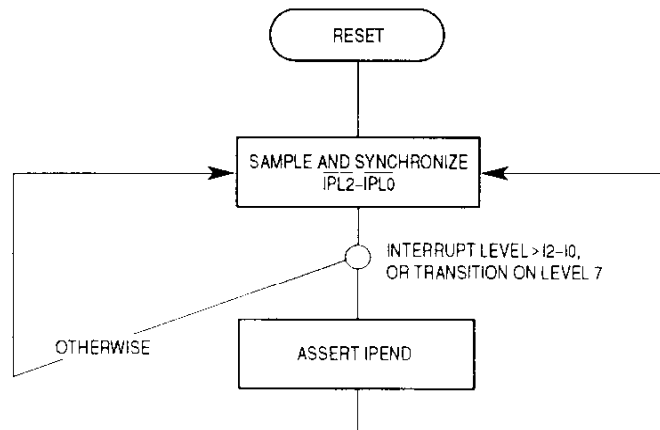

Figure 7-25. Interrupt Pending Procedure

The MC68060 asserts \overline{IPEND} when an interrupt request is pending. Figure 7-26 illustrates the assertion of \overline{IPEND} relative to the assertion of an interrupt level on the \overline{IPLx} signals. \overline{IPEND} signals external devices that an interrupt exception will be taken at an upcoming

Bus Operation

instruction boundary (following any higher priority exception). The \overline{IPEND} signal negates after the interrupt acknowledge bus cycle.

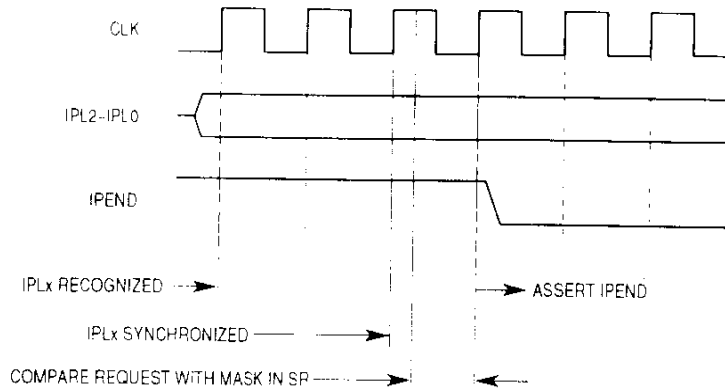

Figure 7-26. Assertion of \overline{IPEND}

\overline{IPEND} is intended to provide status information, and must not be used to replace the interrupt acknowledge cycle. As such, normal applications do not rely on \overline{IPEND} to disable interrupts. Applications that use \overline{IPEND} as a replacement for the interrupt acknowledge cycle are neither recommended nor supported.

The MC68060 takes an interrupt exception for a pending interrupt within one instruction boundary after processing any other pending exception with a higher priority. Thus, the MC68060 executes at least one instruction in an interrupt exception handler before recognizing another interrupt request. The following paragraphs describe the various kinds of interrupt acknowledge bus cycles that can be executed as part of interrupt exception processing. Table 7-4 provides a summary of the possible interrupt acknowledge terminations and the exception processing results. Note that \overline{TRA} must always be negated for proper operation in the MC68040 acknowledge termination mode.

Table 7-4. Interrupt Acknowledge Termination Summary

Acknowledge Termination Mode	TA	TEA	TRA	AVEC	Termination Condition
Either	High	High	High	Don't Care	Insert Wait States
MC68040	High	Low	High	Don't Care	Take Spurious Interrupt Exception
Native-MC68060	Don't Care	Low	Don't Care	Don't Care	
Either	Low	High	High	High	Register Vector Number on D7-D0 and Take Interrupt Exception
Either	Low	High	High	Low	Take Autovector Interrupt Exception
MC68040	Low	Low	High	Don't Care	Retry Interrupt Acknowledge Cycle
Native-MC68060	Don't Care	High	Low	Don't Care	
MC68040	Don't Care	Don't Care	Low	Don't Care	Illegal Combination, Unsupported

7.8.1.1 INTERRUPT ACKNOWLEDGE CYCLE (TERMINATED NORMALLY). When the MC68060 processes an interrupt exception, it performs an interrupt acknowledge bus cycle to obtain the vector number that contains the starting location of the interrupt exception handler. Some interrupting devices have programmable vector registers that contain the interrupt vectors for the exception handlers they use. Other interrupting conditions or devices cannot supply a vector number and use the autovector bus cycle described in **7.8.1.2 Autovector Interrupt Acknowledge Cycle**.

The interrupt acknowledge bus cycle is a read transfer. It differs from a normal read cycle in the following respects:

- TT1 and TT0 = \$3 to indicate an acknowledged bus cycle
- Address signals A31--A0 are set to all ones (\$FFFFFFF)
- TM2--TM0 are set to the interrupt request level (the inverted values of \overline{IPLx}).

The responding device places the vector number on the lower byte of the data bus during the interrupt acknowledge bus cycle, and the cycle is terminated normally with \overline{TA} . Figure 7-27 and Figure 7-28 illustrate a flowchart and functional timing diagram for an interrupt acknowledge cycle terminated with \overline{TA} .

Note that the acknowledge termination ignore state capability is applicable to the interrupt acknowledge cycle. If enabled, \overline{TA} and other acknowledge termination signals are ignored for a user-programmed number of BCLK cycles.

7.8.1.2 AUTOVECTOR INTERRUPT ACKNOWLEDGE CYCLE. When the interrupting device cannot supply a vector number, it requests an automatically generated vector (autovector). Instead of placing a vector number on the data bus and asserting \overline{TA} , the device asserts the autovector (\overline{AVEC}) signal with \overline{TA} to terminate the cycle. \overline{AVEC} is only sampled with \overline{TA} asserted. \overline{AVEC} can be grounded if all interrupt requests are autovectored.

The vector number supplied in an autovector operation is derived from the interrupt priority level of the current interrupt. When the \overline{AVEC} signal is asserted with \overline{TA} during an interrupt acknowledge bus cycle, the MC68060 ignores the state of the data bus and internally generates the vector number, which is the sum of the interrupt priority level plus 24 (\$18). There are seven distinct autovectors that can be used, corresponding to the seven levels of interrupts available with \overline{IPLx} signals. Figure 7-29 illustrates a functional timing diagram for an autovector operation.

Note that the acknowledge termination ignore state capability is applicable to the interrupt acknowledge cycle. If enabled, \overline{AVEC} and other acknowledge termination signals are ignored for a user-programmed number of BCLK cycles.

7.8.1.3 SPURIOUS INTERRUPT ACKNOWLEDGE CYCLE. When a device does not respond to an interrupt acknowledge bus cycle, spurious with \overline{TA} , or \overline{AVEC} and \overline{TA} , the external logic typically returns the transfer error acknowledge signal (\overline{TEA}). In this case, the MC68060 automatically generates the spurious interrupt vector number 24 (\$18) instead of the interrupt vector number. If operating in the MC68040 acknowledge termination mode,



Bus Operation

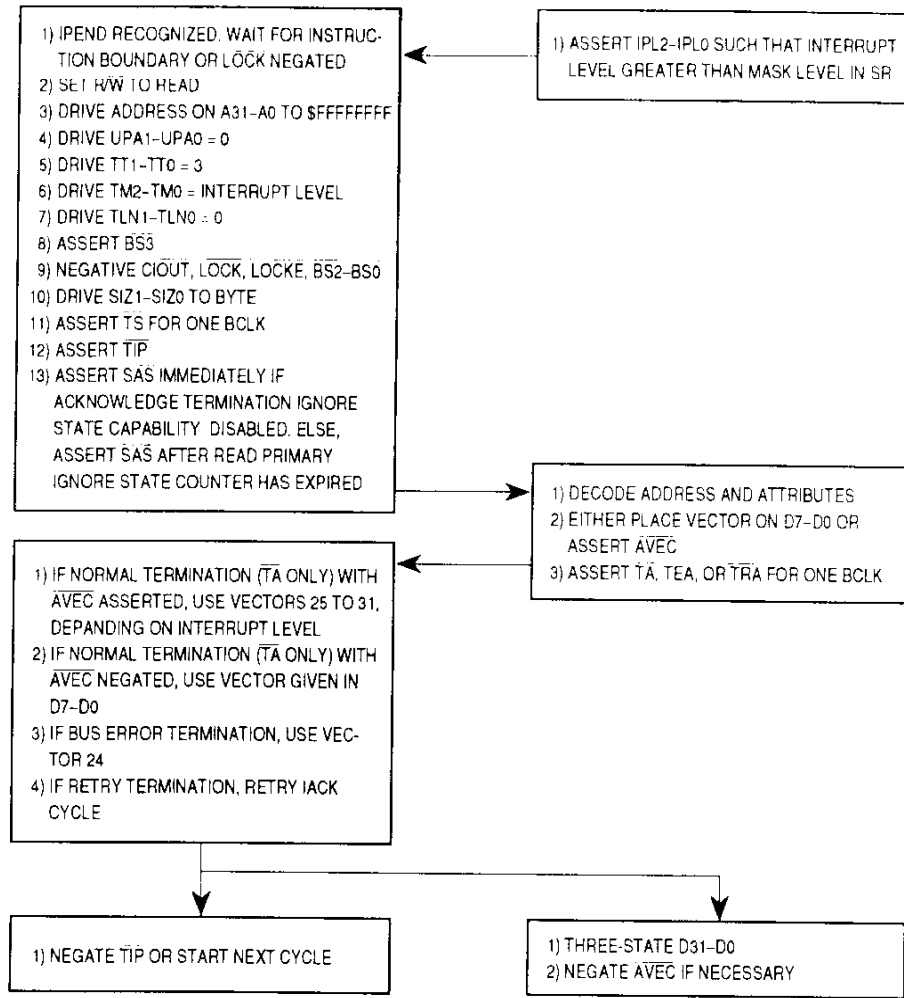

Figure 7-27. Interrupt Acknowledge Cycle Flowchart

and if \overline{TA} and \overline{TEA} are both asserted, the processor retries the cycle. If operating in native-MC68060 acknowledge termination mode, a retry is indicated by the assertion of \overline{TRA} .

Note that the acknowledge termination ignore state capability is applicable to the interrupt acknowledge cycle. If enabled, \overline{TA} , \overline{TEA} , \overline{TRA} , and other acknowledge termination signals are ignored for a user-programmed number of BCLK cycles.

7.8.2 Breakpoint Acknowledge Cycle

The execution of a BKPT instruction generates the breakpoint acknowledge cycle. An acknowledged access is a read bus cycle and is indicated with $TT1, TT0 = \$3$, address $A31-A0 = \$00000000$, and $TM2-TM0 = \$0$. When the external device terminates the cycle with either \overline{TA} or \overline{TEA} , the processor takes an illegal instruction exception. A retry termination simply retries the breakpoint acknowledge cycle. Figure 7-30 and Figure 7-31 illustrate a flowchart and functional timing diagram for a breakpoint acknowledge bus cycle.

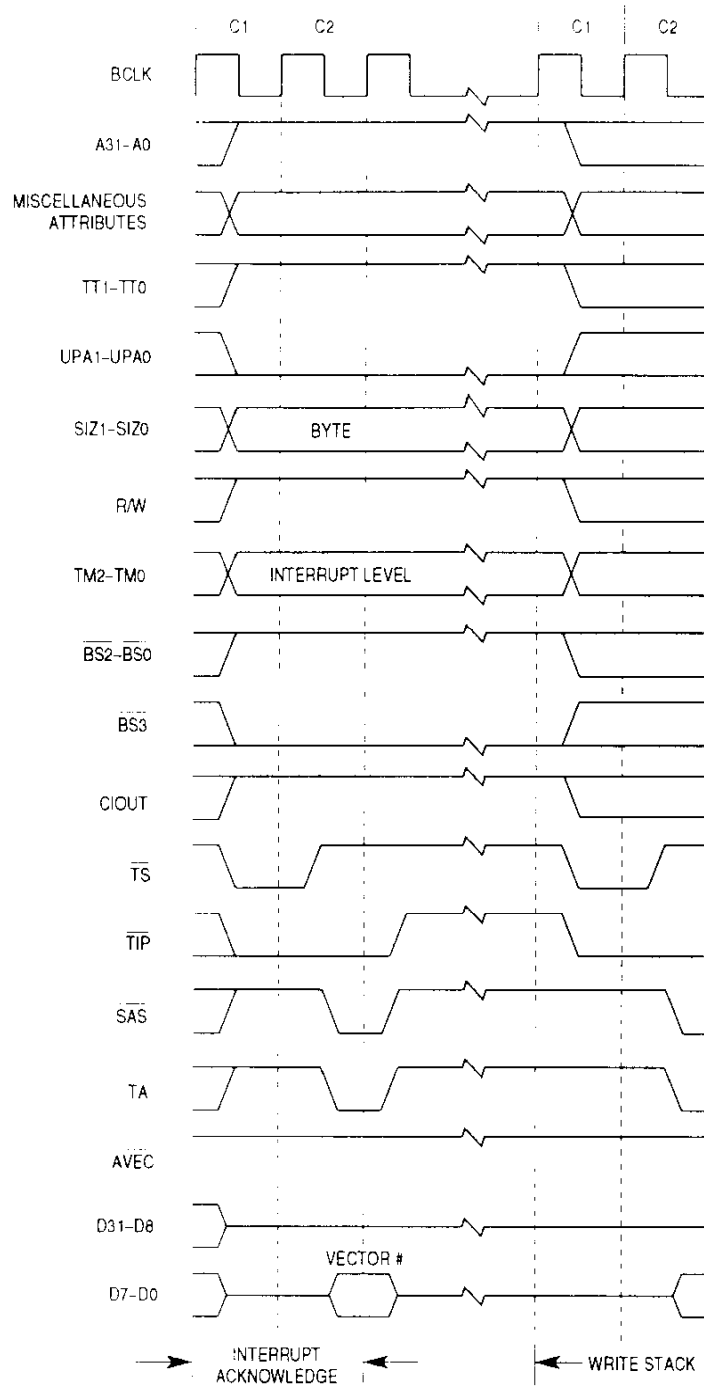

Figure 7-28. Interrupt Acknowledge Bus Cycle Timing

Note that the acknowledge termination ignore state capability is applicable to the breakpoint acknowledge cycle. If enabled, \overline{TA} , \overline{TEA} , and \overline{TRA} are ignored for a user-programmed number of BCLK cycles.

Bus Operation

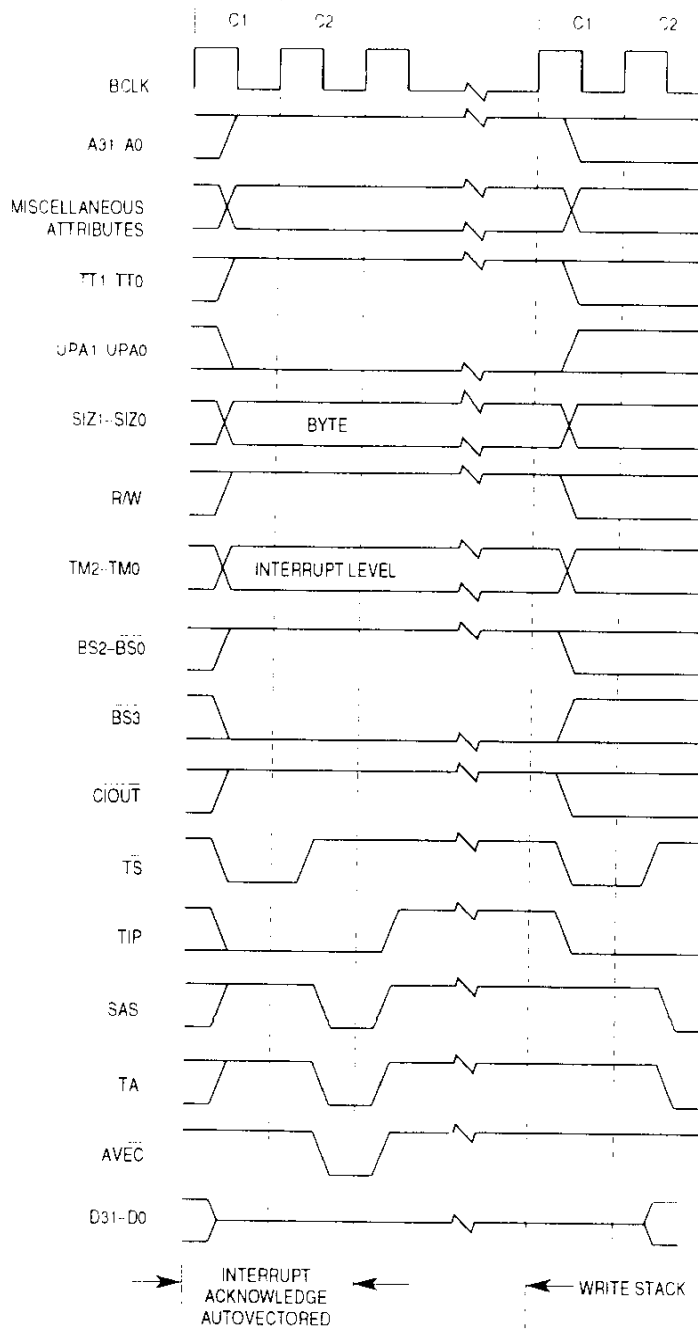

Figure 7-29. Autovector Interrupt Acknowledge Bus Cycle Timing

7.8.2.1 LPSTOP BROADCAST CYCLE. The execution of an LPSTOP instruction generates the LPSTOP broadcast cycle. This access is a write bus cycle and is indicated with $TT1, TT0 = \$3$, $A31-A0 = \$FFFFFFE$, and $TM2-TM0 = \$0$. When an external device terminates the cycle with either \overline{TA} or \overline{TEA} , the processor enters the low-power stop mode. A

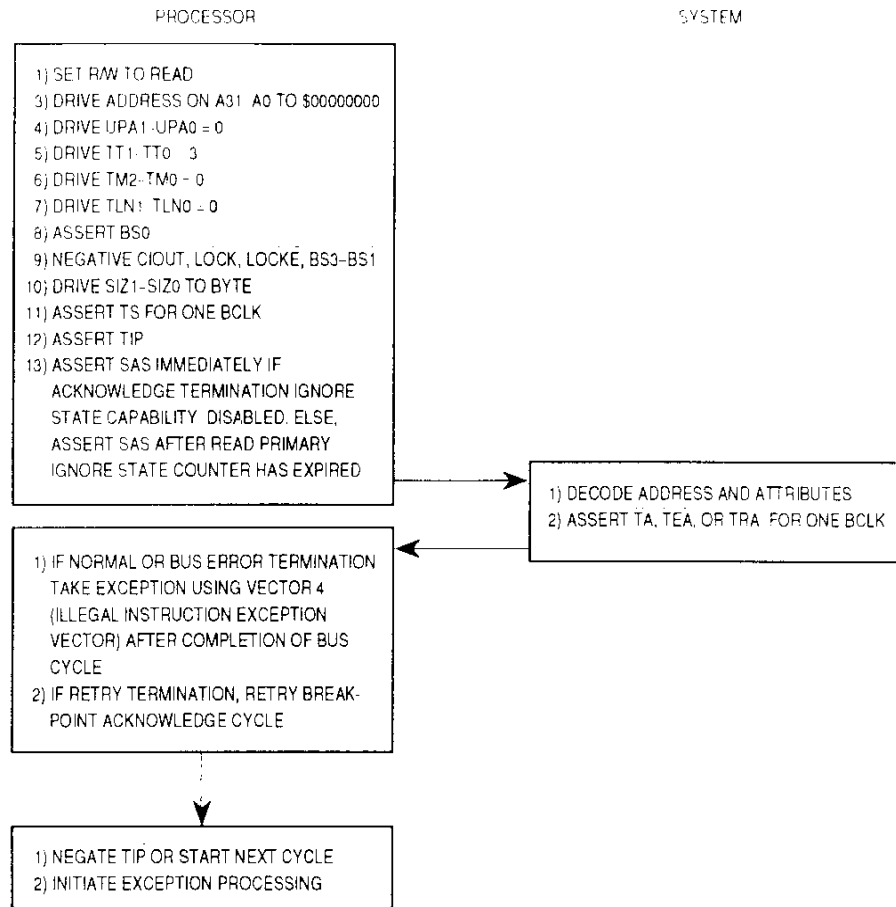

Figure 7-30. Breakpoint Interrupt Acknowledge Cycle Flowchart

retry termination simply retries the LPSTOP broadcast cycle. The lower data bits D15–D0 are driven with the LPSTOP immediate word value and the upper data bits D31–D16 are driven high. After a number of CLK cycles, PSTx change to \$16. The timing of when the PSTx signals are updated relative to the LPSTOP broadcast cycle is undefined.

Once the LPSTOP broadcast cycle is finished, no bus arbitration activity is performed by the MC68060. Furthermore, it is imperative that no alternate master bus activity be done from the time the LPSTOP broadcast cycle is finished to when the LPSTOP encoding is indicated by PSTx. For systems that require the MC68060 to be three-stated when in the LPSTOP mode, the bus must be arbitrated away during the LPSTOP broadcast cycle. This is easily achieved by having the \overline{BG} input negated at the same time as \overline{TA} or \overline{TEA} . For additional power savings, CLK may be stopped in the low state while in the LPSTOP mode. Systems must ensure that CLK only be stopped when the PSTx signals indicate \$16.

Figure 7-32 illustrates a flowchart of the LPSTOP broadcast cycle. Figure 7-33 and Figure 7-34 illustrate functional timing diagrams for an LPSTOP broadcast cycle as a function of \overline{BG} .

Bus Operation

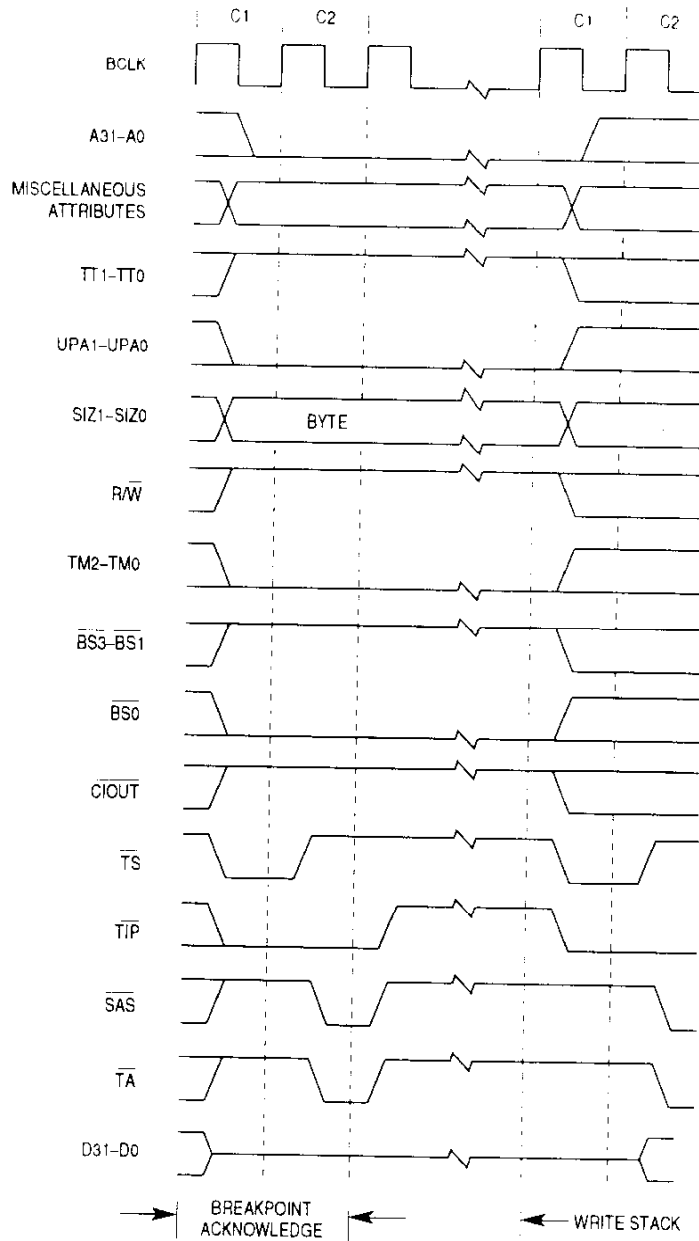

Figure 7-31. Breakpoint Interrupt Acknowledge Bus Cycle Timing

To exit the LPSTOP mode, the processor CLK must be restarted for at least eight CLK and two BCLK periods prior to asserting either the \overline{RSTI} or generating an interrupt. It is imperative before asserting \overline{RSTI} or generating the interrupt no alternate master activity be done until the processor begins exception processing for either the reset or interrupt. Additionally, the following control signals must be pulled-up or negated during this time: \overline{BB} , \overline{TRA} , \overline{TA} , \overline{TEA} , \overline{CLA} , \overline{BGR} , \overline{BG} , \overline{SNOOP} , \overline{AVEC} , \overline{MDIS} , \overline{CDIS} , \overline{TCI} , and \overline{TBI} . The processor uses the PSTx encoding of \$18 to indicate exception processing.

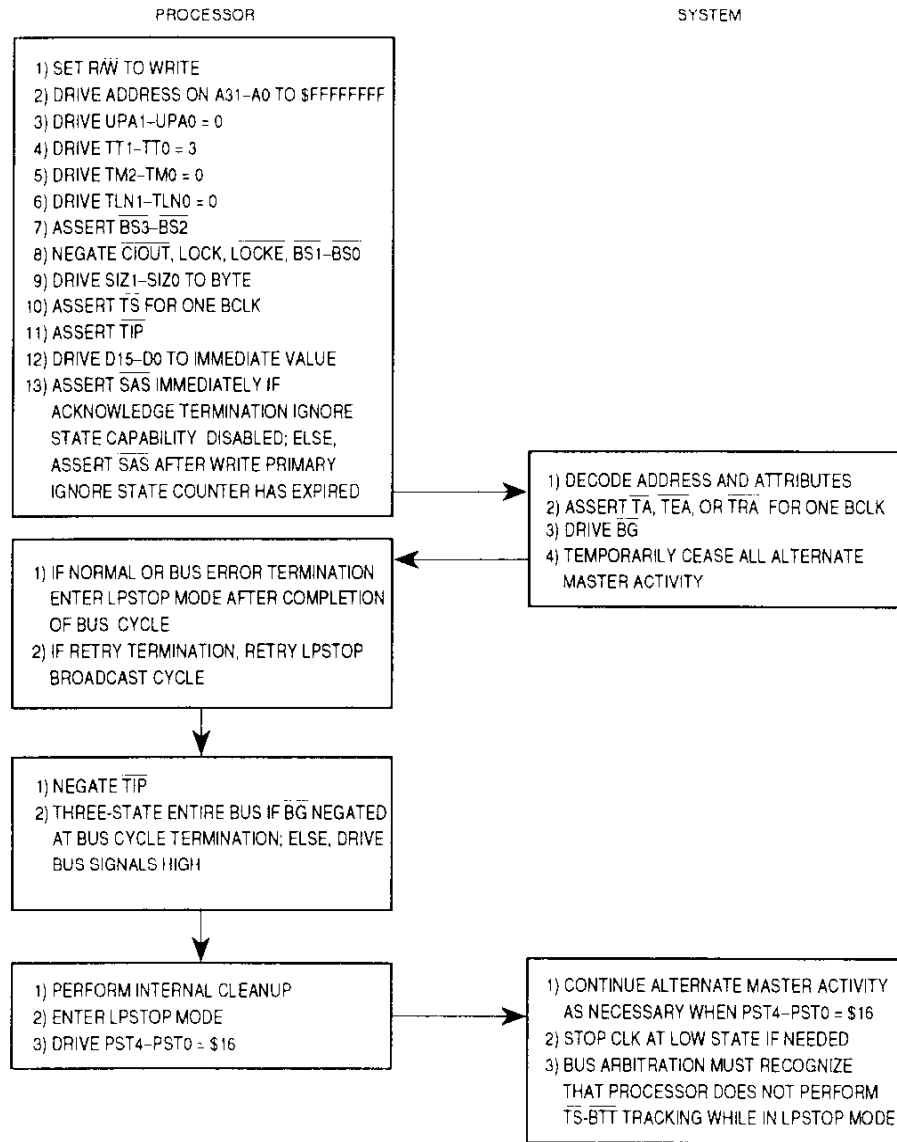

Figure 7-32. LPSTOP Broadcast Cycle Flowchart

In normal applications, the requirement to keep the above-mentioned control signals negated while exiting the LPSTOP condition should be easy to meet, since most of these signals should already have pullup resistors and keeping alternate master activity from occurring would allow the pullup resistors to keep these control signals negated. However, strict compliance for the \overline{BGR} and \overline{AVEC} signals is not necessary because these signals are significant only during locked sequences (\overline{BGR}) and interrupt acknowledge cycles (\overline{AVEC}), neither of which is pending when exiting the LPSTOP condition.

Bus Operation

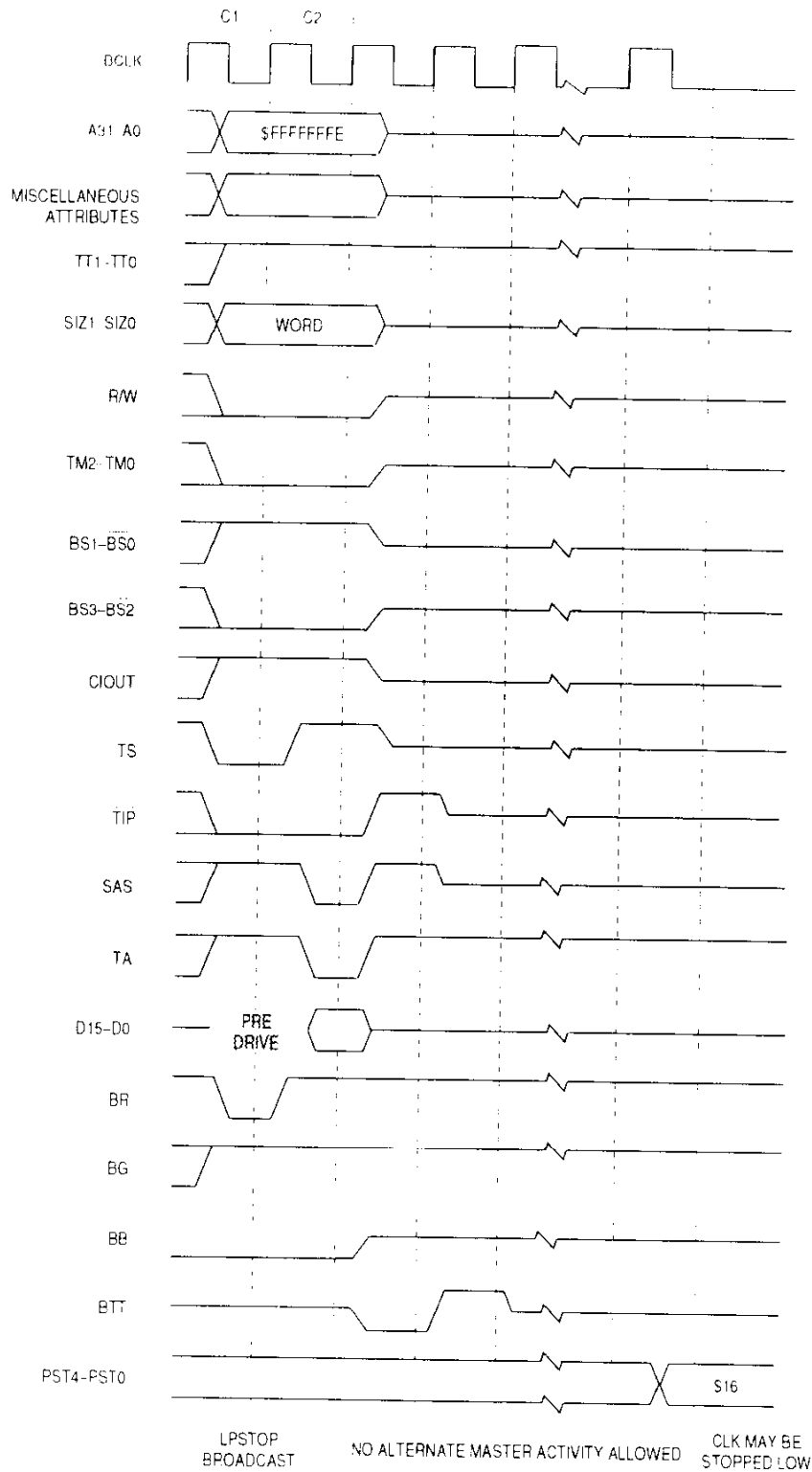

Figure 7-33. LPSTOP Broadcast Bus Cycle Timing, \overline{BG} Negated

Bus Operation

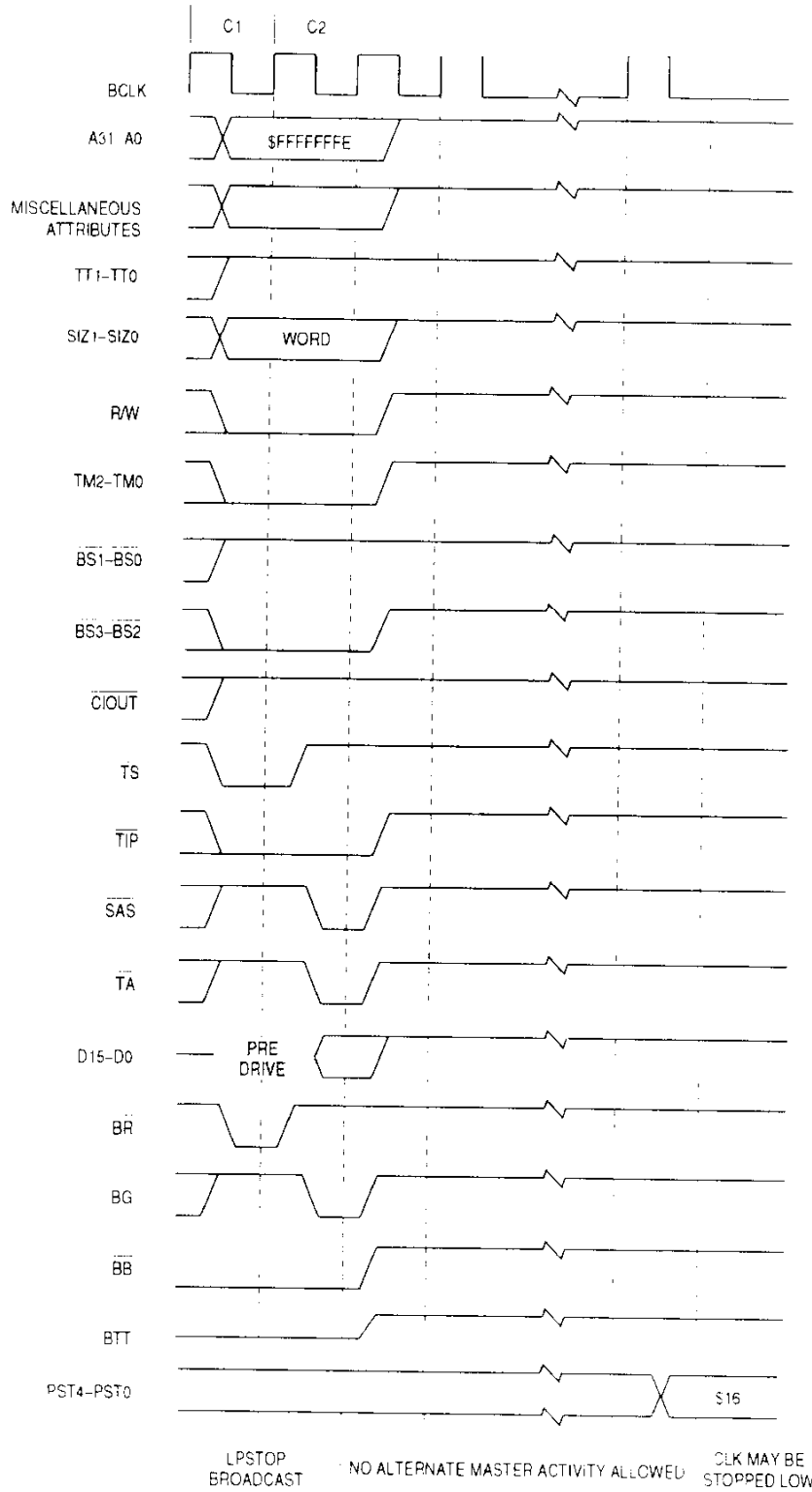

Figure 7-34. LPSTOP Broadcast Bus Cycle Timing, \overline{BG} Asserted

Bus Operation

Figure 7-35 illustrates a flowchart for exiting the LPSTOP mode, and Figure 7-36 illustrates the bus activity when exiting the LPSTOP mode, assuming that an interrupt is used to awaken the processor and that the bus is initially three-stated.

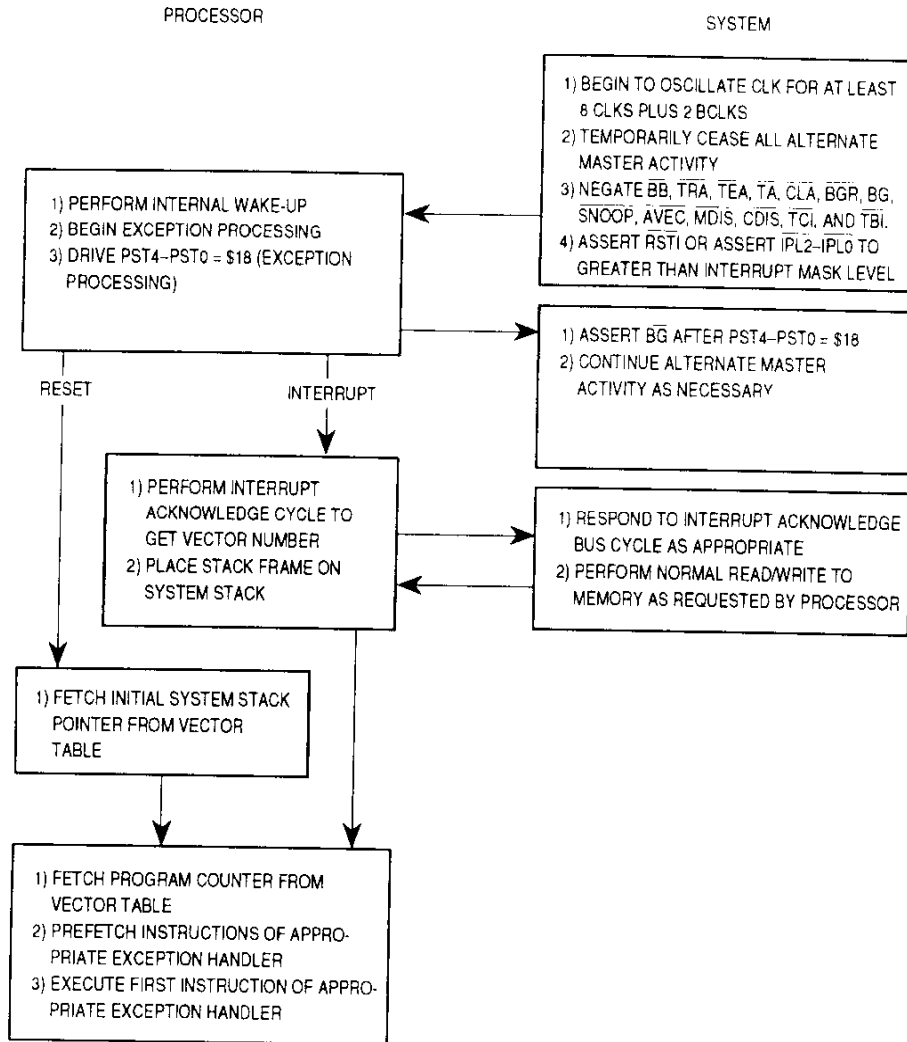

Figure 7-35. Exiting LPSTOP Mode Flowchart

Note that the acknowledge termination ignore state capability is applicable to the LPSTOP broadcast cycle. If enabled, \overline{TA} , \overline{TEA} , and \overline{TRA} are ignored for a user-programmed number of BCLK cycles.

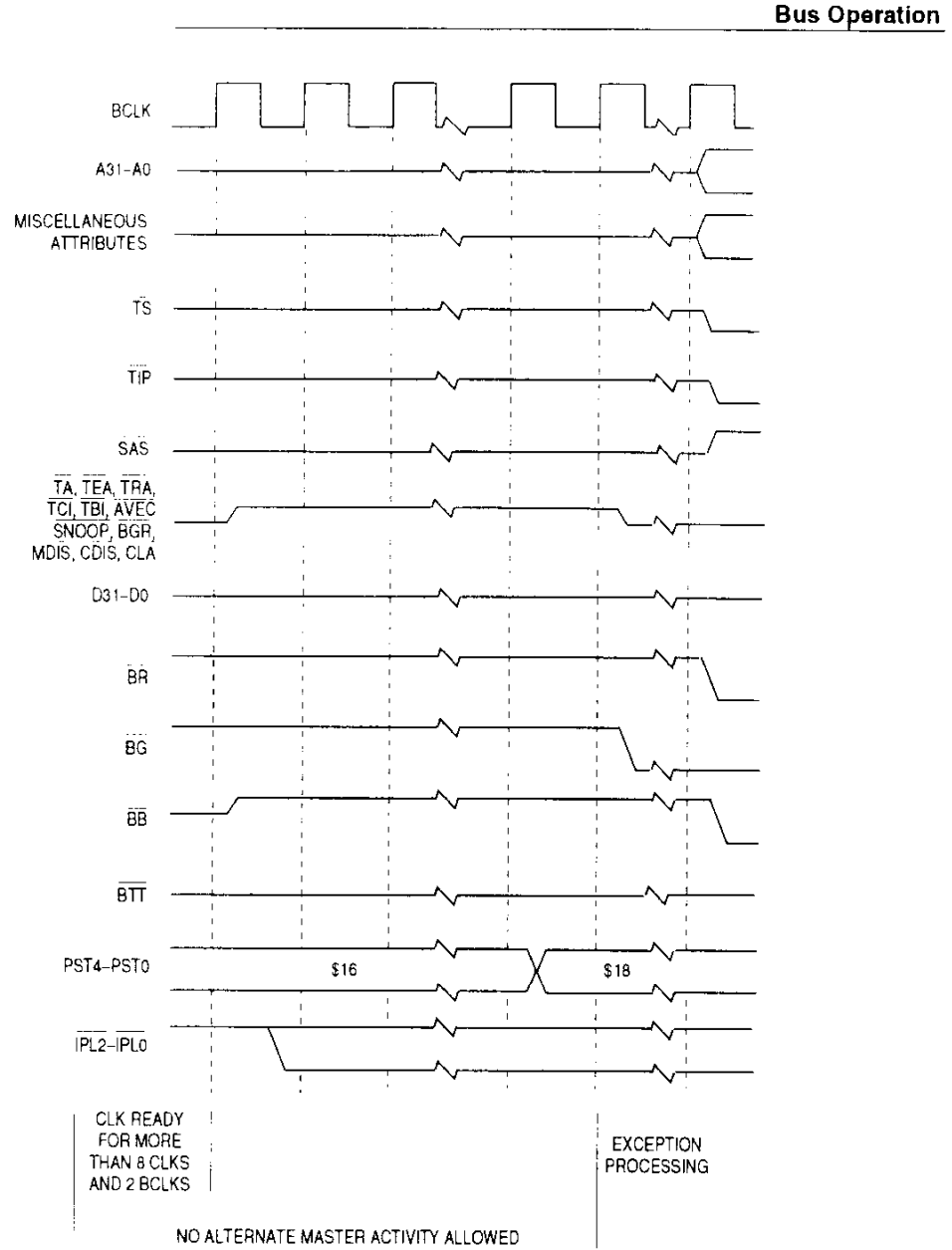

Figure 7-36. Exiting LPSTOP Mode Timing Diagram

Bus Operation

7.9 BUS EXCEPTION CONTROL CYCLES

The MC68060 bus architecture requires assertion of \overline{TA} from an external device to signal that a bus cycle is complete. \overline{TA} is not asserted in the following cases:

- The external device does not respond.
- No interrupt vector is provided.
- Various other application-dependent errors occur.

External circuitry can provide \overline{TEA} when no device responds by asserting \overline{TA} within an appropriate period of time after the processor begins the bus cycle. This allows the cycle to terminate and the processor to enter exception processing for the error condition. A retry may be indicated by asserting \overline{TEA} in combination with \overline{TA} in the MC68040 acknowledge termination mode or by asserting \overline{TRA} if in the native-MC68060 acknowledge termination mode.

To properly control termination of a bus cycle for a bus error or retry condition, \overline{TA} and \overline{TEA} must be asserted and negated about the same rising edge of BCLK when using the MC68040 acknowledge termination mode. Table 7-5 lists the control signal combinations and the resulting bus cycle terminations. Bus error and retry terminations during burst cycles operate as described in 7.7.2 Line Read Transfer and 7.7.4 Line Write Cycles

Table 7-5. Termination Result Summary

Acknowledge Termination Mode	\overline{TA}	\overline{TEA}	\overline{TRA}	Result
MC68040 Native-MC68060	High Don't Care	Low Low	High Don't Care	Bus Error—Terminate and Take Bus Error Exception, Possibly Deferred
MC68040 ¹ Native-MC68060 ²	Low Don't Care	Low High	High Low	Retry Operation—Terminate and Retry
Either	Low	High	High	Normal Cycle Terminate and Continue
Either	High	High	High	Insert Wait States
MC68040	Don't Care	Don't Care	Low	Illegal operation, Not Supported

NOTES:

1. A retry termination in MC68040-mode is valid only for the first long word of a line transfer and is considered a bus error termination otherwise. Note that for burst-inhibited line transfers, the resulting long-word bus cycles are considered part of the original line transfer and would therefore cause a bus error termination as well.
2. A retry termination in native-MC68060-mode is valid only for the first long word of a line transfer it is ignored otherwise. Note that for burst-inhibited line transfers, the resulting long-word bus cycles are considered part of the original line transfer and would therefore ignore the retry termination as well.

7.9.1 Bus Errors

The system hardware can use the \overline{TEA} signal to abort the current bus cycle when a fault is detected. A bus error is recognized during a bus cycle when \overline{TA} is negated and \overline{TEA} is asserted (MC68040 acknowledge termination mode) or during a bus cycle when \overline{TEA} is asserted (native-MC68060 acknowledge termination mode). Also, for the MC68040 acknowledge termination mode, a retry termination during the 2nd, 3rd, or 4th long word of a line transfer is interpreted as a bus error termination. This rule applies also for the second, third, and fourth long-word transfer on a line transfer that was burst inhibited.



When the processor recognizes a bus error condition for an access, the access is terminated immediately. A line access that has \overline{TEA} asserted for one of the four long-word transfers aborts without completing the remaining transfers, regardless of whether the line transfer uses a burst or burst-inhibited access.

When a bus cycle is terminated with a bus error, the MC68060 can enter access error exception processing immediately following the bus cycle, or it can defer processing the exception. The instruction prefetch mechanism requests instruction words from the instruction memory unit before it is ready to execute them. If a bus error occurs on an instruction fetch, the processor does not take the exception until it attempts to use the instruction. Should an intervening instruction cause a branch or should a task switch occur, the access error exception for the unused access does not occur. Similarly, if a bus error is detected on the second, third, or fourth long-word transfer for a line read access, an access error exception is taken only if the execution unit is specifically requesting that long word. The line is not placed in the cache, and the processor repeats the line access when another access references the line. If a misaligned operand spans two long words in a line, a bus error on either the first or second transfer for the line causes exception processing to begin immediately. A bus error termination for any write access or read access that reference data specifically requested by the execution unit causes the processor to begin exception processing immediately. Refer to **Section 8 Exception Processing** for details of access error exception processing.

7

When a bus error terminates an access, the contents of the corresponding cache can be affected in different ways, depending on the type of access. For a cache line read to replace a valid instruction or data cache line, the cache line is untouched if the replacement line read terminates with a bus error. If a dirty data cache line is being replaced, the dirty line is placed in the push buffer and is eventually written out to memory. This is done whether or not a bus error occurs during the replacement line read. If any cache push results in a bus error termination, the cache push data is lost.

Write accesses to memory pages specified as cachable writethrough by the data memory unit update the corresponding cache line before accessing memory. If a bus error occurs during a memory access, the cache line remains valid with the new data. For noncachable precise memory pages, the cache line is not updated if the write cycle terminates with a bus error. Figure 7-37 illustrates a functional timing diagram of a bus error on a word write access causing an access error exception. Figure 7-38 illustrates a functional timing diagram of a bus error on a line read access that does not cause an access error exception.

In general, write cycles that result in bus error termination must be avoided. The MC68060 has write and push buffers to decouple the processor from the system. Before the processor writes into the write and push buffers, access errors that result from address translation cache (ATC) faults should have been reported via an access error exception and eventually fixed by the access error handler. Since the instruction that reports the bus error on the write cycle usually is not the instruction that causes the write, it is not possible to recover that write cycle via an instruction restart. Although the fault address indicates the logical address of the write cycle that incurred the bus error, the write data information is not available in the access error stack. As such, this access error case is nonrecoverable unless the system is

Bus Operation

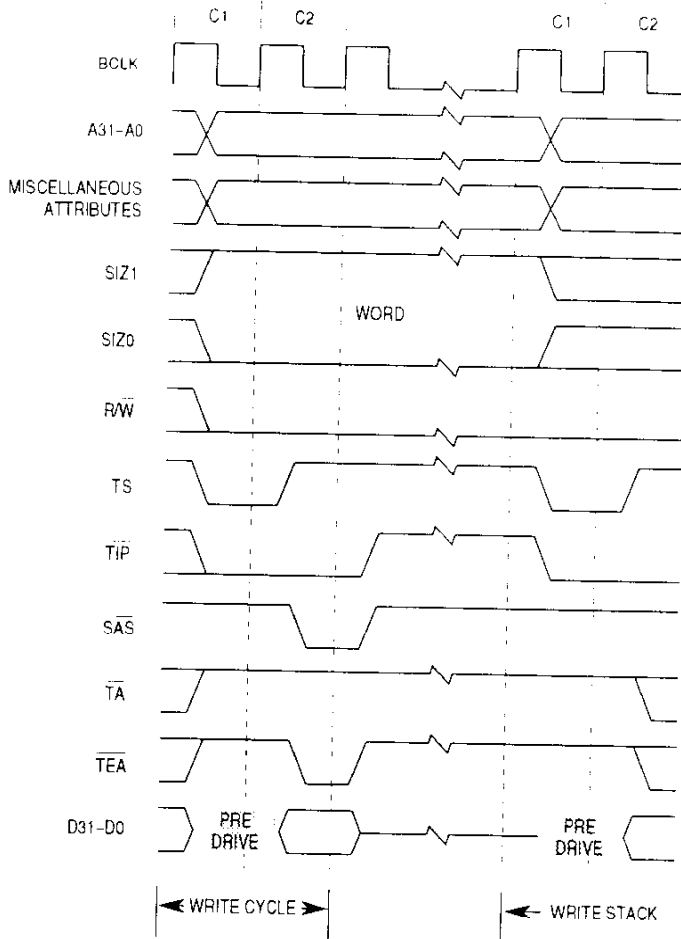

Figure 7-37. Word Write Access Bus Cycle Terminated with \overline{TEA} Timing

implemented with an external device that latches the write data when a bus error terminates a write cycle.

7.9.2 Retry Operation

When an external device asserts both the \overline{TA} and \overline{TEA} signals during a bus cycle in the MC68040 acknowledge termination mode or if an external device asserts \overline{TRA} with \overline{TEA} negated during a bus cycle in the native-MC68060 acknowledge termination mode, the processor enters the retry bus operation sequence. The processor terminates the bus cycle and immediately retries the bus cycle using the same access information (address and transfer attributes). However, if the bus cycle was a cache push operation and the bus is arbitrated away from the MC68060 before the retry operation with a snoop access during the arbitration which invalidates the cache push, the processor does not initiate a retry operation. Figure 7-39 illustrates a functional timing diagram for a retry of a read bus transfer.

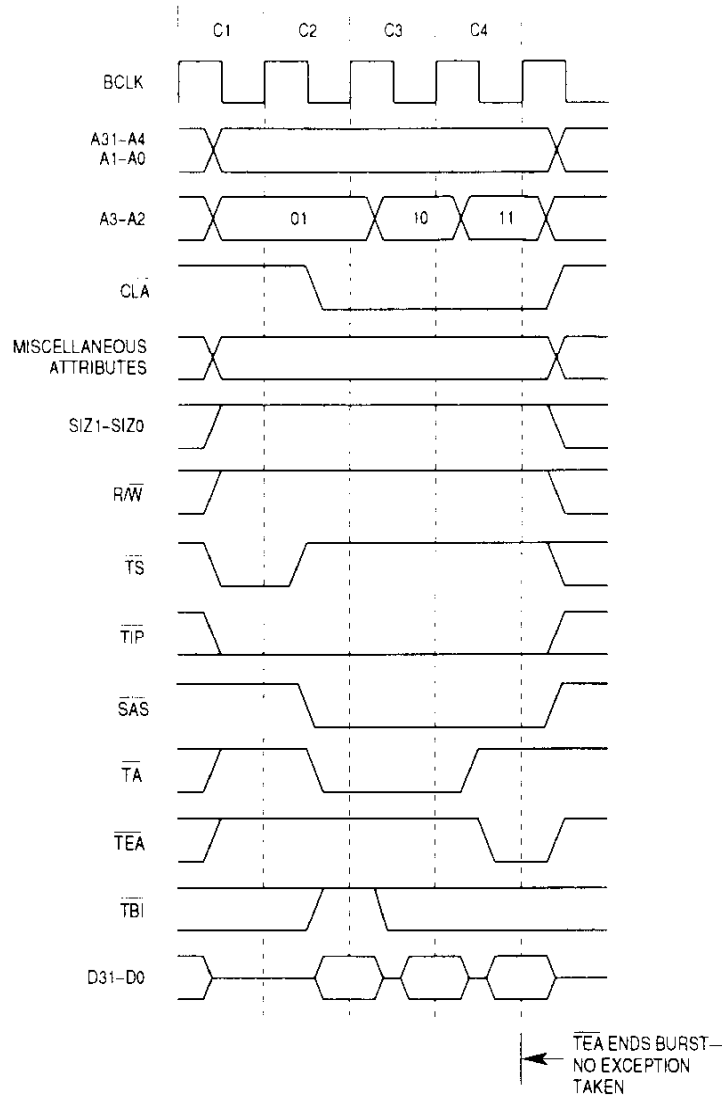

Figure 7-38. Line Read Access Bus Cycle Terminated with \overline{TEA} Timing

The processor retries any read or write bus cycles of a read-modify-write sequence separately; \overline{LOCK} remains asserted during the entire retry sequence. If the last bus cycle of a locked access is retried, \overline{LOCKE} remains asserted through the retry of the write bus cycle.

When in the MC68040 acknowledge termination mode, a retry termination on the initial long-word transfer of a line access causes the processor to retry the bus cycle as illustrated in Figure 7-40. However, the processor interprets a retry bus operation signaled during the second, third, or fourth long-word transfer of a line burst bus cycle as a bus error and causes the processor to abort the line transfer. However, when in the native-MC68060 acknowledge termination mode, a retry termination signaled during the second, third, or fourth long-word transfers of a line burst bus cycle are ignored.

Bus Operation

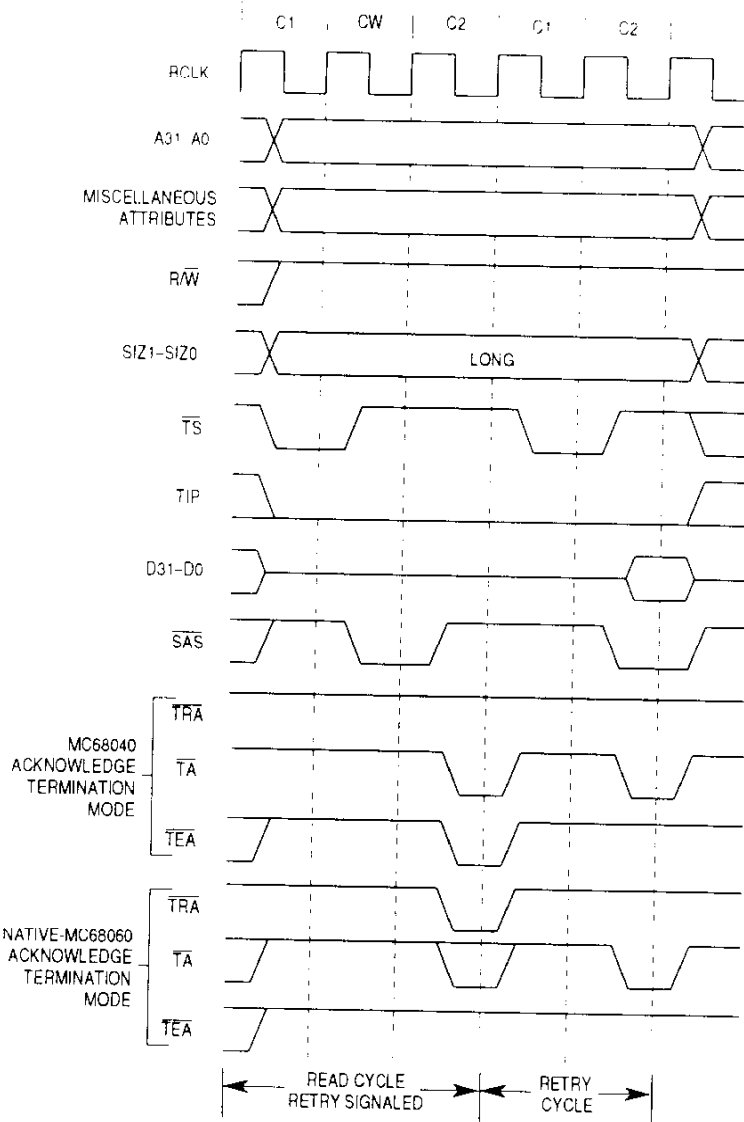

Figure 7-39. Retry Read Bus Cycle Timing

The MC68060 considers the resulting second, third, and fourth long-word bus cycles of a burst-inhibited line transfer as part of the original line transfer cycle. Therefore, the MC68060 interprets a retry termination during these bus cycles as though they were part of the original line transfer, and depending on the acknowledge termination mode, a retry termination is either interpreted as a bus error (MC68040 mode) or ignored (native-MC68060 mode).

Negating the bus grant (\overline{BG}) signal on the MC68060 while indicating a retry termination provides a relinquish and retry operation for any bus cycle that can be retried (see Figure 7-44). If retrying a bus cycle that is part of a locked sequence of bus cycles, a relinquish and retry of the bus requires \overline{BGR} be asserted along with \overline{BG} negated to cause the processor to abort any following locked bus cycles that are a part of the locked sequence.

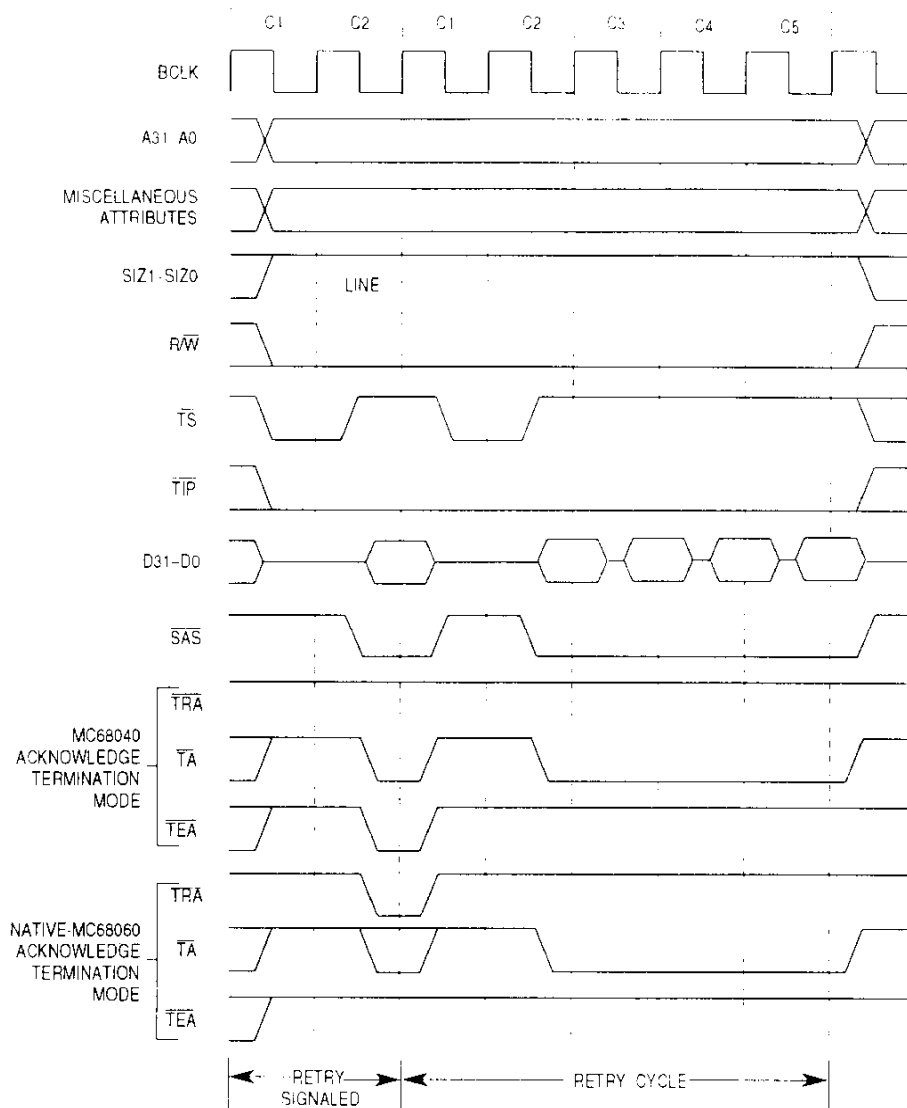

Figure 7-40. Line Write Retry Bus Cycle Timing

7.9.3 Double Bus Fault

A double bus fault occurs when an access or address error occurs during the exception processing sequence, e.g., the processor attempts to stack several words containing information about the state of the machine while processing an access error exception. If a bus error occurs during the stacking operation, the second error is considered a double bus fault and the processor is halted.

The MC68060 indicates a double bus fault condition by continuously driving PSTx with an encoded value of \$1C until the processor is reset. Only an external reset operation can restart a halted processor. The halted processor releases the external bus by negating \overline{BR} and forcing all outputs to a high-impedance state.

Bus Operation

A second access or address error that occurs during execution of an exception handler or later, does not cause a double bus fault. A bus cycle that is retried does not constitute a bus error or contribute to a double bus fault. The processor continues to retry the same bus cycle as long as external hardware requests it.

7.10 BUS SYNCHRONIZATION

The MC68060 integer unit generates access requests to the instruction and data memory units to support integer and floating-point operations. Both the <ea> fetch and write-back stages of the integer unit pipeline perform accesses to the data memory unit. All read and write accesses are performed in strict program order. Compared with the MC68040, the MC68060 is always "serialized". This feature makes it possible for automatic bus synchronization without requiring NOPs between instructions to guarantee serialization of reads and writes to I/O devices.

The instruction restart model used for exception processing in the MC68060 may require special care when used with certain peripherals. After the operand fetch for an instruction, an exception that causes the instruction to be aborted can occur, resulting in another access for the operand after the instruction restarts. For example, an exception could occur after a read access of an I/O device's status register. The exception causes the instruction to be aborted and the register to be read again. If the first read accesses clears the status bits, the status information is lost, and the instruction obtains incorrect data.

7.11 BUS ARBITRATION

The bus design of the MC68060 provides for one bus master at a time, either the MC68060 or an external device. More than one device having the capability to control the bus can be attached to the bus. An external arbiter prioritizes requests and determines which device is granted access to the bus. Bus arbitration is the protocol by which the processor or an external device becomes the bus master. When the MC68060 is the bus master, it uses the bus to read instructions and transfer data not contained in its internal caches to and from memory. When an alternate bus master owns the bus, the MC68060 can be made to monitor the alternate bus master's transfer and maintain cache coherency. This capability is discussed in more detail in **7.12 Bus Snooping Operation**.

Like the MC68040, the MC68060 implements an arbitration method in which an external arbiter controls bus arbitration and the processor acts as a slave device requesting ownership of the bus from the arbiter. Since the user defines the functionality of the external arbiter, it can be configured to support any desired priority scheme. For systems in which the processor is the only possible bus master, the bus can be continuously granted to the processor, and no arbiter is needed. Systems that include several devices that can become bus masters require an arbiter to assign priorities to these devices so, when two or more devices simultaneously attempt to become the bus master, the one having the highest priority becomes the bus master first. The MC68060 bus interface controller generates bus requests to the external arbiter in response to internal requests from the instruction and data memory units.

The MC68060 supports two bus arbitration protocols. These arbitration protocols are mutually exclusive and must not be mixed in a system. An MC68040-style arbitration protocol is

provided for compatibility with existing MC68040-based ASICs and logic. This arbitration protocol uses the \overline{BR} , \overline{BG} , and \overline{BB} signals. Bus tenure terminated (\overline{BTT}) must be ignored by the external arbiter and pulled high using a separate pullup resistor on the MC68060 pin when using this arbitration protocol.

In addition to the MC68040-arbitration protocol, a high speed MC68060-arbitration protocol is introduced to provide arbitration activity at higher frequencies. This arbitration protocol uses the \overline{BR} , \overline{BG} , \overline{BTT} , and \overline{BGR} signals. \overline{BB} must be ignored by the external arbiter and pulled high using a separate pullup resistor on the MC68060 when using this arbitration protocol.

In either arbitration protocol, the bus arbitration unit in the MC68060 operates synchronously and transitions between states in which CLK is enabled via \overline{CLKEN} asserted (on the rising edge of BCLK). Either arbitration protocol allows arbitration to overlap with bus activity, but the MC68040-arbitration protocol should not be used at full bus speed. With either arbitration protocol, each master which can initiate bus cycles must have their \overline{TS} signals connected together so that the MC68060 can maintain proper internal state. Note also, when using the MC68040-arbitration protocol, any alternate master which takes over bus ownership and initiates bus cycles with the assertion of \overline{TS} must also assert \overline{BB} for the time of its bus tenure.

7.11.1 MC68040-Arbitration Protocol (\overline{BB} Protocol)

When using the MC68040-arbitration protocol, \overline{BTT} must be pulled high through a resistor. Since \overline{BTT} is also an output, a separate pullup resistor must be used exclusively for \overline{BTT} .

The MC68060 requests the bus from the external bus arbiter by asserting \overline{BR} whenever an internal bus request is pending. The processor continues to assert \overline{BR} for as long as it requires the bus. The processor negates \overline{BR} at any time without regard to the status of \overline{BG} and \overline{BB} . If the bus is granted to the processor when an internal bus request is generated, \overline{BR} is asserted simultaneously with transfer start (\overline{TS}), allowing the access to begin immediately. The processor always drives \overline{BR} , and \overline{BR} cannot be wire-ORed with other devices.

The external arbiter asserts \overline{BG} to indicate to the processor that it has been granted the bus. If \overline{BG} is negated while a bus cycle is in progress, the processor relinquishes the bus at the completion of the bus cycle, except on locked sequences in which \overline{BGR} is negated. To guarantee that the bus is relinquished, \overline{BG} must be negated prior to the rising edge of the BCLK in which the last \overline{TA} , \overline{TEA} , or \overline{TRA} is asserted. Note that the bus controller considers the four long-word bus transfers of a burst-inhibited line transfer to be a single bus cycle and does not relinquish the bus until completion of the fourth transfer.

Unlike the MC68040 in which the read and write portions of a locked sequence is divisible, the MC68060 provides a choice via the \overline{BGR} input. If \overline{BGR} is asserted when \overline{BG} is negated in the middle of a locked sequence, the MC68060 operates like the MC68040 and relinquishes the bus after the current bus cycle is completed. Otherwise, if \overline{BGR} is negated when \overline{BG} is negated, the MC68060 ignores the negated \overline{BG} , retains bus ownership, and completes all bus cycles of the locked sequence before giving up the bus. Systems may use the \overline{BGR} input to assign severity of the \overline{BG} negation. For instance, if bus arbitration is used to allow for DRAM refresh, it is okay to ignore locked sequences and force the MC68060 to

Bus Operation

relinquish the bus. But, if the alternate master is another MC68060, it may not be advisable to allow locked sequences to be broken. Figure 7-46 illustrates \overline{BGR} functionality on locked sequences.

When the bus has been granted to the processor in response to the assertion of \overline{BR} , one of two situations can occur. In the first situation, the processor monitors \overline{BB} and \overline{TS} to determine when the bus cycle of the alternate bus master is complete and to guarantee that another master has not already started another bus tenure. After the alternate bus master negates and three-states \overline{BB} , the processor asserts \overline{BB} to indicate explicit bus ownership and begins the bus cycle by asserting \overline{TS} . The processor continues to assert \overline{BB} until the external arbiter negates \overline{BG} , after which \overline{BB} is driven negated at the completion of the bus cycle, then forced to a high-impedance state. As long as \overline{BG} is asserted, \overline{BB} remains asserted to indicate the bus is owned, and the processor continuously drives the address bus, attributes, and control signals. The processor negates \overline{BR} when there are no pending internal requests to allow the external arbiter to grant the bus to an alternate bus master if necessary.

7

In the second situation, the processor samples \overline{BB} until the alternate master negates \overline{BB} . Then the processor takes implicit ownership of the bus. Implicit ownership of the bus occurs when the processor is granted the bus, but there are no pending bus cycles. The MC68060 does not drive the bus and \overline{BB} if the bus is implicitly owned. This is different from the MC68040 which drives the address, attributes, and control signals during implicit ownership of the bus. If an internal access request is generated, the processor assumes explicit ownership of the bus and immediately begins an access, simultaneously asserting \overline{BB} , \overline{BR} , \overline{TIP} , and \overline{TS} . If the external arbiter keeps \overline{BG} asserted to the processor, the processor keeps \overline{BB} asserted and either executes active bus cycles or drives the address and attributes with undefined values in-between active bus cycles.

\overline{BR} can be used by the external arbiter as an indication that the processor needs the bus. However, there is no guarantee that when the bus is granted to the processor, that a bus cycle will be performed. At best, \overline{BR} must be used as status output that the processor needs the bus, but not as an indication that the processor is in a certain bus arbitration state. Figure 7-41 provides a high-level arbitration diagram that can be used by external arbiters to predict how the MC68060 operates as a function of external signals, and internal signals. For instance, note that the relationship between the internal \overline{BR} and the external \overline{BR} is best described as a synchronous delay off BCLK.

Figure 7-41 is a bus arbitration state diagram for the MC68040 bus arbitration protocol. Table 7-6 lists conditions that cause a change to and from the various states. Table 7-7 lists a summary of the bus conditions and states.

Table 7-6. MC68040-Arbitration Protocol Transition Conditions

Present State	Condition	RSTI	BG	TS sampled as an input TSI	SNOOP	BB sampled as an input (BBI)	Internal Bus Request (IBR)	Transfer in Progress?	End of Cycle?	Next State
Reset	A1	A	—	—	—	—	—	—	—	Reset
	A2	A	A	—	—	—	—	—	—	Implicit Own
	A3	N	N	—	—	—	—	—	—	AM Implicit
Explicit Own	B1	N	N	—	—	—	—	N	—	End Tenure
	B2	N	N	—	—	—	—	A	N	Explicit Own
	B3	N	N	—	—	—	—	A	A	End Tenure
	B4	N	A	—	—	—	—	—	—	Explicit Own
End Tenure	C1	N	N	N	—	N	—	—	—	AM Implicit
	C2	N	A	—	—	—	N	—	—	Implicit Own
	C3	N	A	—	—	—	A	—	—	Explicit Own
	C4	N	N	A	—	—	—	—	—	Violation
	C5	N	N	—	—	A	—	—	—	Violation
AM Implicit	D1	N	—	A	A	—	—	—	—	Snoop
	D2	N	—	A	N	—	—	—	—	AM Explicit
	D3	N	N	N	—	—	—	—	—	AM Implicit
	D4	N	A	N	—	N	N	—	—	Implicit Own
	D5	N	A	N	—	N	A	—	—	Explicit Own
	D6	N	A	N	—	A	—	—	—	AM Explicit
AM Explicit	E1	N	—	A	A	—	—	—	—	Snoop
	E2	N	—	A	N	—	—	—	—	AM Explicit
	E3	N	—	N	—	A	—	—	—	AM Explicit
	E4	N	A	N	—	N	N	—	—	Implicit Own
	E5	N	A	N	—	N	A	—	—	Explicit Own
	E6	N	N	N	—	N	—	—	—	AM Implicit
Implicit Own	F1	N	N	N	—	—	—	—	—	AM Implicit
	F2	N	A	—	—	—	N	—	—	Implicit Own
	F3	N	A	—	—	—	A	—	—	Explicit Own
	F4	N	N	A	—	—	—	—	—	Violation
Snoop	G1	—	—	—	—	—	—	—	—	AM Explicit
Any		A	—	—	—	—	—	—	—	Reset

NOTES:

- 1) "N" means negated; "A" means asserted.
- 2) End of Cycle: Whatever terminates a bus transaction whether it is normal, bus error, or retried. Note that on-word bus cycles that result from a burst-inhibited line transfer are considered part of that original line transfer.
- 3) Conditions C4, C5, and F4 indicate that an alternate master has taken ownership without sampling BB as negated.
- 4) IBR refers to an internal bus request. The output signal BR is a registered version of IBR.
- 5) BBI refers to BB when sampled as an input.
- 6) SNOOP denotes the condition in which SNOOP is sampled asserted and TT1 = 0.
- 7) In this state diagram, BGR is assumed always asserted, hence, bus cycles within a locked sequence are treated no differently from nonlocked bus cycles, except that the processor takes an extra BCLK period in the end tenure state to allow for LOCK and LOCKE to negate. If BGR is negated and a locked sequence is in progress, the processor does not relinquish the bus if BG is negated until the end of the last bus cycle in the locked sequence.
- 8) The processor does not require a valid acknowledge termination for snooped accesses. The only restriction is that a snoop cycle be performed at no more than a maximum rate of once every two BCLK cycles. This state diagram properly emulates this behavior.



Bus Operation

Table 7-7. MC68040-Arbitration Protocol State Description

BBO	Bus Status	Own	State
Not Driven	Not Driven	No	Reset
Not Driven	Not Driven	No	Alternate Master Implicit Own
Not Driven	Not Driven	No	Alternate Master Explicit Own
Not Driven	Not Driven	Yes	Implicit Ownership
Asserted	Driven	Yes	Explicit Ownership
Negated for One CLK, then Three-Stated	Stops Being Driven at End of State	Yes	End Tenure
Not Driven	Not Driven	No	Alternate Master Own and Snooped

NOTE:

BBO represents the component of BB when driven by the MC68060. BBO is either driven asserted or three-stated; however, BBO is driven negated for one CLK (as opposed to BCLK) period before three-stating.

The MC68060 can be in any one of seven bus arbitration states during bus operation: reset, AM-implicit own, AM-explicit own, snoop, implicit ownership, explicit ownership, and the end tenure states.

The reset state is entered whenever \overline{RSTI} is asserted in any bus arbitration state, except the explicit ownership state. For that state, the end tenure state is entered prior to entering the reset state. This is done to ensure other bus masters are capable of taking the bus away from the processor when it is reset. When \overline{RSTI} is negated, the processor proceeds to the implicit ownership state or alternate master implicit ownership state, depending on \overline{BG} . If an alternate master asserts \overline{TS} or has asserted \overline{TS} in the past, the processor waits for \overline{BTT} to assert (or alternatively, for \overline{BB} to go from being asserted to being negated) before taking the bus, even though \overline{BG} may be asserted to the processor.

The AM-implicit own state denotes the MC68060 does not have ownership (\overline{BG} negated) of the bus and is not in the process of snooping an access, and the alternate has not begun its tenure by asserting \overline{TS} (alternate master \overline{TS} or \overline{SNOOP} negated). In the AM-implicit own state, the MC68060 does not drive the bus. The processor enters the AM-explicit own state when \overline{TS} is asserted by the alternate master. Once in the AM-explicit own state, the processor waits for the alternate master to transition and negate \overline{BB} (or alternatively assert \overline{BTT}) before recognizing that a change of tenure has occurred. If \overline{BG} is negated when \overline{BB} is negated (or alternatively \overline{BTT} asserted), the processor assumes that another master has taken implicit ownership of the bus. Otherwise, if \overline{BG} is asserted when \overline{BB} is negated (or \overline{BTT} asserted), the processor assumes implicit ownership of the bus.

If an alternate master loses bus ownership when it is in its implicit ownership state, the processor checks \overline{TS} . If \overline{TS} is sampled asserted, the processor interprets this as the alternate master transitioning to its explicit ownership state, and it does not take over bus ownership. This operation is different from that of the MC68040, in that external arbiters are required to check for this boundary condition. However, in order for the processor to properly detect this boundary condition, it is imperative that the \overline{TS} of all alternate bus masters be tied together with the processor's \overline{TS} signal.

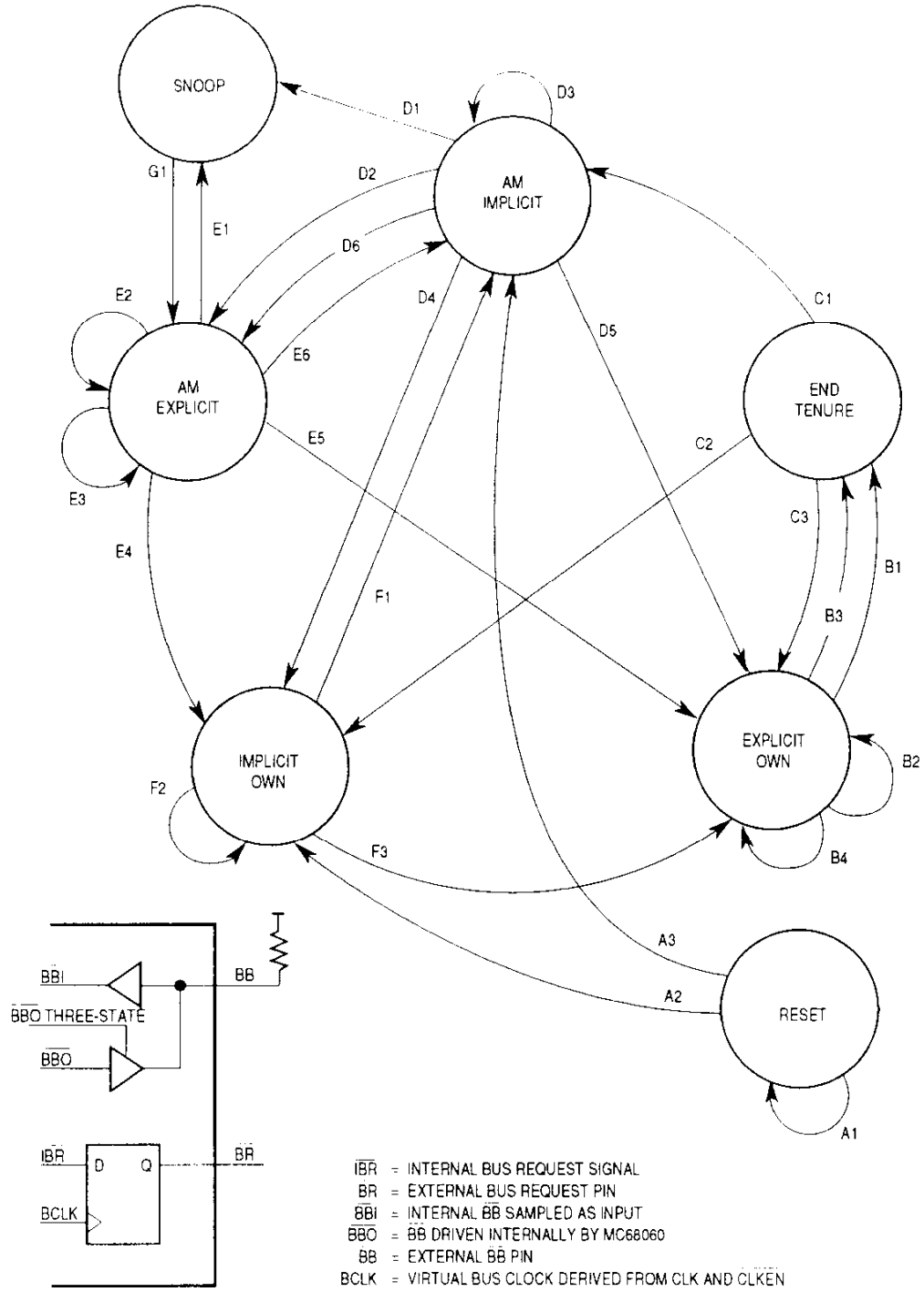

Figure 7-41. MC68040-Arbitration Protocol State Diagram

Bus Operation

The snoop state is similar to the AM-explicit own state in that the MC68060 does not have ownership of the bus. The snoop state differs from the AM-explicit own state in that the MC68060 is in the process of performing an internal snoop operation because the processor has detected that \overline{TS} and \overline{SNOOP} are asserted and $TT1 = 0$. The snoop state always returns to the AM-explicit own state.

The implicit ownership state indicates that the MC68060 owns the bus because \overline{BG} is asserted to it. The processor, however, is not ready to begin a bus cycle, and it keeps \overline{BB} negated and the bus three-stated until an internal bus request occurs.

The MC68060 explicitly owns the bus when the bus is granted to it (\overline{BG} asserted) and at least one bus cycle has initiated. The processor asserts \overline{BB} during this state to indicate the processor has explicit ownership of the bus. Until \overline{BG} is negated, the processor retains explicit ownership of the bus whether or not active bus cycles are being executed. When the processor is ready to relinquish the bus, it goes through the end tenure state to indicate to all alternate masters that it is relinquishing the bus. During the end tenure state, \overline{BB} goes from being actively asserted to being actively negated for one CLK cycle and then three-stated. While in this state, \overline{RSTI} is asserted and the processor proceeds to the end tenure state to inform other bus masters it is relinquishing the bus.

7.11.2 MC68060-Arbitration Protocol (\overline{BTT} Protocol)

The MC68060-arbitration protocol is different from the MC68040-arbitration protocol in that \overline{BTT} is used instead of \overline{BB} . \overline{BTT} indicates that the MC68060 has completed a bus tenure and the bus can now be used by another master. When using the MC68060-arbitration protocol, \overline{BB} must be pulled high via a separate pullup resistor since the processor drives \overline{BB} during bus tenure times. This pullup resistor must be used solely for \overline{BB} .

Arbitration within the MC68060 bus interface controller is based on current bus ownership and the concept that a bus cycle is an atomic entity which cannot be split, though it may be prematurely terminated. If the bus is currently owned by the processor, it can be owned by another master only after the completion of the final bus cycle when the processor has asserted \overline{BTT} .

If the bus is not currently owned by the processor, it asserts its \overline{BR} signal as soon as it needs the bus. Bus mastership is assumed as soon as the assertion of \overline{BG} is received from the bus arbiter and the one BCLK period assertion of the bused \overline{BTT} is detected (or alternately, the transition and negation of \overline{BB} is detected at a rising BCLK edge), indicating the previous master has terminated its tenure and relinquished the bus. If the MC68060 still has a need to use the bus when \overline{BG} is received, it assumes bus mastership, asserts \overline{TS} , and starts a bus cycle. Note the MC68060 negates its \overline{BR} signal if, due to internal state, it no longer needs to use the bus at that moment in time. It negates its \overline{BR} signal at the same time it asserts the \overline{TS} signal if the bus is only needed for one bus cycle.

\overline{BTT} is connected to all masters in a system to give notice of the termination of bus tenure by the MC68060 processor. \overline{BTT} is asserted by the MC68060 after it has lost right of ownership to the bus by the negation of \overline{BG} and is ready to end usage of the bus. After the final termination acknowledgment of the final bus cycle when the MC68060 has lost bus ownership, the processor asserts \overline{BTT} for a one BCLK period, negates \overline{BTT} for a one BCLK period.

and then three-states \overline{BTT} . If the external bus arbiter has granted the bus to an alternate master by the assertion of \overline{BG} to that master, that master, using this protocol, can start a bus cycle on the rising BCLK edge in which it detects the assertion of \overline{BTT} . The previous master can be driving \overline{BTT} negated at the same time the current master is starting a bus cycle because the current master will still have its \overline{BTT} signal three-stated. Since the alternate master does not drive \overline{BTT} in this protocol until it has finished its tenure, there is no conflict with tying all master's \overline{BTT} signals together. This is different than the MC68040-arbitration protocol which used \overline{BB} to continuously indicate to other bus masters the bus was being used by the MC68040.

When a processor using the MC68040-arbitration protocol is finished using the bus, \overline{BB} has to be driven negated for a short period of time and then three-stated. The use of the \overline{BTT} protocol works much better than the \overline{BB} protocol in a high-speed bus environment because the kind of drive (asserted, negated, or three-stated) of \overline{BTT} can be synchronous with the clock. Arbiters do not need to be changed going from a MC68040 system to a MC68060 system, since arbiters do not need to sample the \overline{BB} signal in a MC68040 system or \overline{BTT} in a MC6060 system, but need only use \overline{BR} , \overline{BG} , and perhaps \overline{LOCK} to determine bus ownership rights. Masters need only sample \overline{BB} or \overline{BTT} and \overline{TS} and \overline{BG} to determine the proper times to take over ownership of the bus. In cases where the MC68060 has implicit bus ownership after it has finished all needed bus cycles, \overline{BTT} remains three-stated until \overline{BG} is negated and the MC68060 is forced off the bus. For this case, in the next BCLK period after the MC68060 detects the negation of \overline{BG} , it asserts \overline{BTT} for one BCLK period, negates \overline{BTT} for one BCLK period, and then three-states \overline{BTT} . In implicit bus ownership cases where the MC68060 is given the bus but never actually uses it by asserting \overline{TS} , the MC68060 does not assert \overline{BTT} when \overline{BG} is negated.

In systems that use the \overline{BTT} protocol, the assertions of \overline{TS} and \overline{BTT} must be tracked by masters, to determine the proper times at which the bus may be taken over. Assertions of \overline{BTT} prior to, during, and after the negation of \overline{BG} may also need to be logged by a master in cases where the \overline{BG} is not parked with a master and no master has used the bus for some time. In such cases the master is required to have kept state information that indicated a previous master had earlier finished using the bus, implying it is safe to immediately take control of the bus. The MC68060 processor internally maintains this information.

After external reset, initiated with the negation of \overline{RSTI} , and with \overline{BG} asserted, the MC68060 does not wait for the assertion of \overline{BTT} by another master to take over mastership of the bus and start bus activity, provided there has been no assertion of \overline{TS} by another master in the interim of time between the negation of \overline{RSTI} and the clock cycle when the MC68060 is ready to start a bus cycle. If another master starts bus activity (\overline{TS} asserted) in this interim of time, even though the MC68060 may have received a bus grant indication (\overline{BG} asserted), the MC68060 waits for \overline{BTT} to be asserted by the other master before it takes over bus mastership.

When \overline{BG} is negated by the arbiter, the MC68060 relinquishes the bus as soon as the current bus cycle is complete unless a locked sequence of bus cycles is in progress with \overline{BGR} negated. In this case, the MC68060 completes the sequence of atomic locked bus cycles, drives \overline{LOCK} and \overline{LOCKE} negated for one BCLK period during the clock when the address and other bus cycle attributes are idled, and in the next BCLK period, three-states \overline{LOCK}

Bus Operation

and \overline{LOCKE} and then relinquishes the bus by asserting \overline{BTT} . \overline{BGR} is a qualifier for \overline{BG} which indicates to the MC68060 the degree of necessity for relinquishing bus ownership when \overline{BG} is negated. \overline{BGR} primarily affects how the MC68060 behaves during atomic locked sequences when \overline{BG} is negated.

The MC68060 arbitration protocol allows bus ownership to be removed from the MC68060 and granted to another bus master with the negation of \overline{BG} , even if the processor is indicating a locked sequence is in progress. A \overline{LOCK} signal is provided by the MC68060 to indicate the processor intends the current set of bus cycles to be locked together, but this can either be enforced or overridden by the system bus arbiter's control of the \overline{BGR} signal. The assertion of \overline{BGR} with the negation of \overline{BG} by an external bus arbiter forces the processor to relinquish the bus as soon as the current bus cycle is finished even if the processor is running a locked sequence of atomic bus cycles. If both \overline{BGR} and \overline{BG} are negated when the MC68060 is running a sequence of locked bus cycles, the MC68060 finishes the entire set of atomic locked bus cycles and then relinquishes the bus at the completion of that unit of atomic locked bus cycles and no disruption of the atomic sequence occurs. Note the MC68060 may be running a set of back-to-back atomic locked sequences, the abutment of which an external bus arbiter can not detect to determine a safe time to negate \overline{BG} . With \overline{BGR} negated the MC68060 finishes the last bus cycle of the current set of atomic locked bus cycles and then relinquishes the bus, thus preventing the interruption of that unit of atomic locked sequence of bus cycles. Figure 7-46 illustrates \overline{BGR} functionality during locked sequences.

As an alternative to the \overline{BGR} protocol, the MC68060 retains the \overline{LOCKE} signal from the MC68040 bus. The MC68040 uses a \overline{LOCKE} signal during the last bus cycle of a locked sequence of bus cycles to allow an external arbiter to detect the boundary between back-to-back locked sequences on the bus. An external arbiter in a MC68040 system can use the \overline{LOCKE} status signal to determine safe times to remove \overline{BG} without breaking a locked sequence and allow arbitration to be overlapped with the last transfer in a locked sequence. However, a retry acknowledge termination during the last bus cycle of a locked sequence with \overline{LOCKE} asserted and \overline{BG} negated requires asynchronous logic in the external bus arbiter to re-assert \overline{BG} before the bus cycle finishes to prevent the splitting or interruption of the locked sequence. Use of the \overline{BGR} protocol prevents this problem by allowing the MC68060 determine the proper time to relinquish bus ownership and simplifies the external bus arbiter design.

For locked sequences of bus cycles, the MC68060 asserts \overline{LOCK} with the \overline{TS} of the first bus cycle and negates \overline{LOCK} following the final termination acknowledgment of the last transfer of the last bus cycle during the execution of the TAS and CAS instructions, on updates of history information in table searches, and after the execution of MOVEC instructions that set and later reset the \overline{LOCK} bit in the BUSCR. Depending on how the arbiter is designed with respect to \overline{LOCK} and \overline{BGR} , this can have the effect of preventing overlapped bus arbitration during locked sequences. By keeping \overline{LOCK} asserted throughout the duration of a locked sequence, the last bus cycle of the sequence can be retried and still maintain the lock status.

The MC68060 processor, like the MC68040, will continue to drive external address and attribute lines, but unlike the MC68040, it may drive undefined values on the address and attribute lines during times when the bus is still owned but idle after a previous usage. Also, unlike the MC68040, in cases of implicit bus ownership, when the MC68060 has been granted the bus but has not yet run a cycle, the processor does not drive the address and attributes lines and they remain three-stated until a bus cycle is actually initiated.

Figure 7-42 shows the behavior of the MC68060 given inputs defined in Table 7-8. The states are defined in Table 7-9. The arbitration state diagram for the MC68060-arbitration protocol is similar to the MC68040-arbitration protocol with the exception that \overline{BB} is no longer used as an input. As with the MC68040-arbitration protocol, the end tenure state is used to inform other bus masters the processor is relinquishing the bus.



Bus Operation

Table 7-8. MC68060-Arbitration Protocol State Transition Conditions

Present State	Condition	RSTI	BG	TS sampled as an input (TSI)	SNOOP	BTT sampled as an input (BTTI)	Internal Bus Request (IBR)	Transfer in Progress?	End of Cycle?	Next State
Reset	A1	A	—	—	—	—	—	—	—	Reset
	A2	N	A	—	—	—	—	—	—	Implicit Own
	A3	N	N	—	—	—	—	—	—	AM Implicit
Explicit Own	B1	N	N	—	—	—	—	N	—	End Tenure
	B2	N	N	—	—	—	—	A	N	Explicit Own
	B3	N	N	—	—	—	—	A	A	End Tenure
	B4	N	A	—	—	—	—	—	—	Explicit Own
End Tenure	C1	N	N	N	—	—	—	—	—	AM Implicit
	C2	N	A	—	—	—	N	—	—	Implicit Own
	C3	N	A	—	—	—	A	—	—	Explicit Own
	C4	N	N	A	—	—	—	—	—	Violation
AM Implicit	D1	N	—	A	A	—	—	—	—	Snoop
	D2	N	—	A	N	—	—	—	—	AM Explicit
	D3	N	N	N	—	—	—	—	—	AM Implicit
	D4	N	A	N	—	—	N	—	—	Implicit Own
	D5	N	A	N	—	—	A	—	—	Explicit Own
AM Explicit	E1	N	—	A	A	—	—	—	—	Snoop
	E2	N	—	A	N	—	—	—	—	AM Explicit
	E3	N	—	N	—	N	—	—	—	AM Explicit
	E4	N	A	N	—	A	N	—	—	Implicit Own
	E5	N	A	N	—	A	A	—	—	Explicit Own
	E6	N	N	N	—	A	—	—	—	AM Implicit
Implicit Own	F1	N	N	N	—	—	—	—	—	AM Implicit
	F2	N	A	—	—	—	N	—	—	Implicit Own
	F3	N	A	—	—	—	A	—	—	Explicit Own
	F4	N	N	A	—	—	—	—	—	Violation
Snoop	G1	N	—	—	—	—	—	—	AM Explicit	
Any	—	A	—	—	—	—	—	—	Reset	

NOTES:

- 1) "N" means negated; "A" means asserted.
- 2) End of cycle: Whatever terminates a bus transaction whether it is normal, bus error, or retried. Note that long-word bus cycles that result from a burst inhibited line transfer are considered part of that original line transfer.
- 3) Conditions C4 and F4 indicate that an alternate master has taken bus ownership without waiting for the current master to assert BTT.
- 4) IBR refers to an internal bus request. The output signal \overline{IBR} is a registered version of IBR.
- 5) BTTI refers to BTT when sampled as an input.
- 6) SNOOP denotes the condition in which \overline{SNOOP} is sampled asserted, and TT1 = 0.
- 7) In this state diagram, \overline{BGR} is assumed always asserted; hence, bus cycles within a locked sequence are treated no differently from nonlocked bus cycles, except that the processor takes an extra BCLK period in the end tenure state to allow for \overline{LOCK} and \overline{LOCKE} to negate. If \overline{BGR} is negated and a locked sequence is in progress, the processor does not relinquish the bus if \overline{BG} is negated until the end of the last bus cycle in the locked sequence.
- 8) The processor does not require a valid acknowledge termination for snooped accesses. The only restriction is that a snoop cycle be performed at no more than a maximum rate of once every two BCLK cycles. This state diagram properly emulates this behavior.

Table 7-9. MC68060-Arbitration Protocol State Description

BTT0	Bus Status	Own	State
Not Driven	Not Driven	No	Reset
Not Driven	Not Driven	No	Alternated Master Implicit Own
Not Driven	Not Driven	No	Alternate Master Explicit Own
Not Driven	Not Driven	Yes	Implicit Ownership
Not Driven	Driven	Yes	Explicit Ownership
Asserted for One BCLK, Negated for One BCLK then Three-States	Stops Being Driven at End of State	Yes	End Tenure
Not Driven	Not Driven	No	Alternate Master Own and Snooped

NOTE: BTT0 represents the component of BTT as driven by the MC68060. BTT is normally three-stated but driven for one BCLK when asserted and one BCLK when negated.

The MC68060 can be in any one of seven bus arbitration states during bus operation: reset, AM-implicit own, AM-explicit own, snoop, implicit ownership, explicit ownership, and the end tenure state.

The reset state is entered whenever \overline{RSTI} is asserted in any bus arbitration state, except the explicit ownership state. For that state, the end tenure state is entered prior to entering the reset state. This is done to ensure other bus masters are capable of taking the bus away from the processor when it is reset. When \overline{RSTI} is negated, the processor proceeds to the implicit ownership state or alternate master implicit ownership state, depending on \overline{BG} . If an alternate master asserts \overline{TS} or has asserted \overline{TS} in the past, the processor waits for \overline{BTT} to assert (or alternatively for \overline{BB} to go from being asserted to being negated) before taking the bus, even though \overline{BG} may be asserted to the processor.

The AM-implicit own state denotes the MC68060 does not have ownership (\overline{BG} negated) of the bus and is not in the process of snooping an access, and the alternate has not begun its tenure by asserting \overline{TS} (alternate master \overline{TS} or \overline{SNOOP} negated). In the AM-implicit own state, the MC68060 does not drive the bus. The processor enters the AM-explicit own state when \overline{TS} is asserted by the alternate master. Once in the AM-explicit own state, the processor waits for the alternate master to assert \overline{BTT} before recognizing that a change of tenure has occurred. If \overline{BG} is negated when \overline{BTT} is asserted, the processor assumes that another master has taken implicit ownership of the bus. Otherwise, if \overline{BG} is asserted when \overline{BTT} is asserted, the processor assumes implicit ownership of the bus.

If an alternate master loses bus ownership when it is in implicit ownership state, the processor checks \overline{TS} . If \overline{TS} is sampled asserted, the processor interprets this as the alternate master transitioning to its explicit ownership state, and it does not take bus ownership. This operation is different from that of the MC68040 in that external arbiters are required to check for this boundary condition. However, in order for the processor to properly detect this boundary condition, it is imperative that the \overline{TS} of all alternate bus masters be tied together with the processor's \overline{TS} signal.



Bus Operation

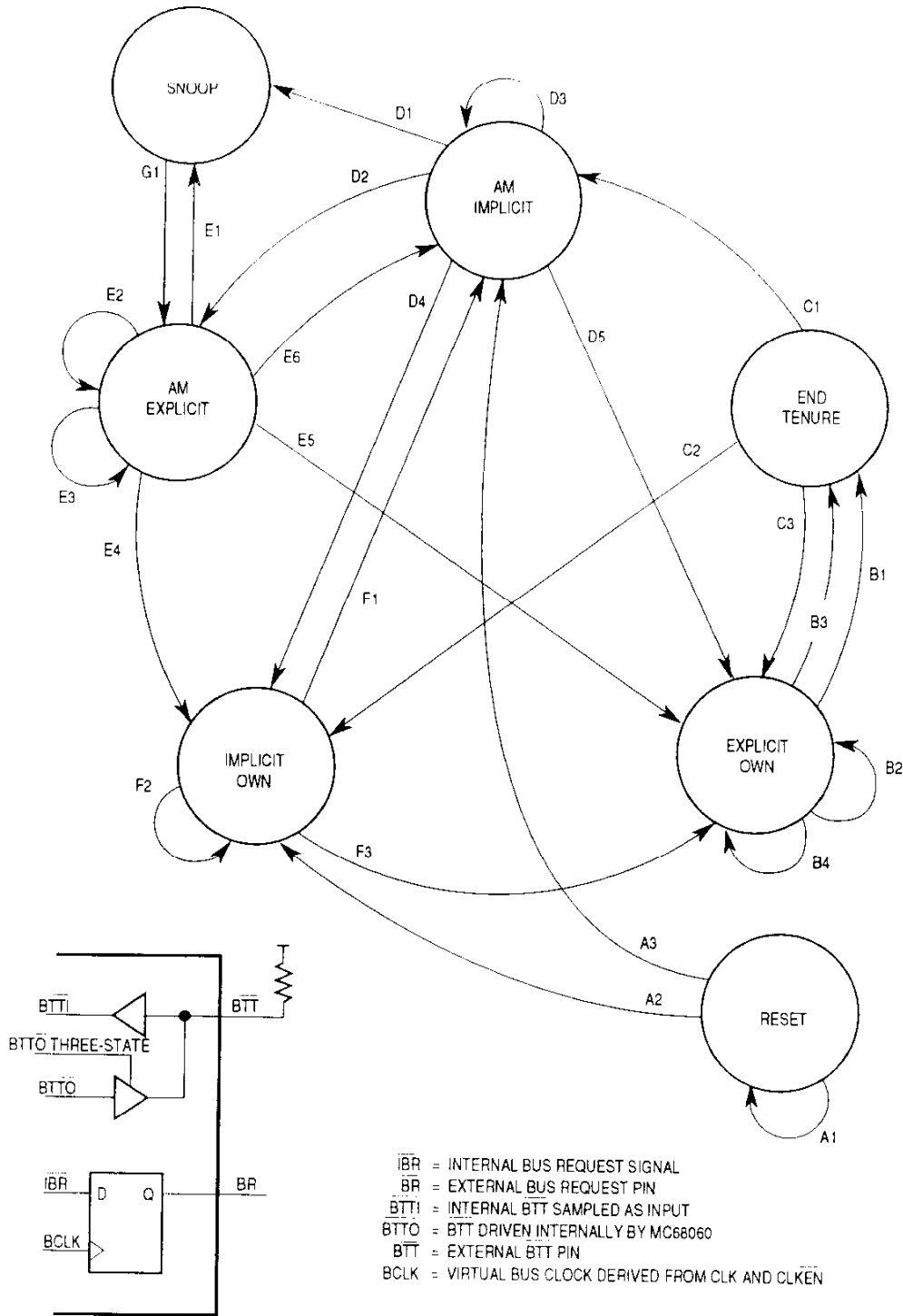

Figure 7-42. MC68060-Arbitration Protocol State Diagram

Freescale Semiconductor, Inc. 7

The snoop state is similar to the AM-explicit own state in that the MC68060 does not have ownership of the bus. The snoop state differs from the AM-explicit own state in that the MC68060 is in the process of performing an internal snoop operation because the processor has detected that \overline{TS} and \overline{SNOOP} are asserted and $TT1 = 0$. The snoop state always returns to the AM-explicit own state. The implicit ownership state indicates that the MC68060 owns the bus because \overline{BG} is asserted to it. The processor, however, is not ready to begin a bus cycle, and keeps \overline{BB} negated and the bus three-stated until an internal bus request occurs.

The MC68060 explicitly owns the bus when the bus is granted to it (\overline{BG} asserted) and it has initiated at least one bus cycle. Until \overline{BG} is negated, the processor retains explicit ownership of the bus whether or not active bus cycles are being executed. When the processor is ready to relinquish the bus, it goes through the end tenure state to indicate to all alternate masters that it is relinquishing the bus. During the end tenure state, \overline{BTT} is asserted for one BCLK and is actively negated for the next BCLK prior to three-stating. While in this state, if \overline{RSTI} is asserted, the processor proceeds to the end tenure state to inform other bus masters it is relinquishing the bus.

All alternate masters that reside in a system and use the MC68060-arbitration protocol must provide the same functionality as the MC68060 for proper system operation.

7

7.11.3 External Arbiter Considerations

The bus arbitration state diagrams for the MC68040-arbitration protocol and MC68060-arbitration protocol may be used to approximate the high level behavior of the processor. In either case, it is assumed that all \overline{TS} signals in a system are tied together, all \overline{BB} signals in a system are tied together and to a pullup resistor (MC68040-arbitration protocol), or all \overline{BTT} signals in a system are tied together and to a pullup resistor (MC68060-arbitration protocol). Furthermore, unused \overline{BB} or \overline{BTT} pins must have separate pullup resistors.

If an alternate master loses bus ownership when it is in its implicit ownership state, the processor checks \overline{TS} . If \overline{TS} is sampled asserted, the processor interprets this as the alternate master transitioning to its explicit ownership state, and it does not take over bus ownership. This operation is different from that of the MC68040, in that external arbiters are required to check for this boundary condition. However, in order for the processor to properly detect this boundary condition, it is imperative that the \overline{TS} of all alternate bus masters be tied together with the processor's \overline{TS} signal.

When using the MC68040-arbitration protocol, as with the \overline{TS} signal, the \overline{BB} of all alternate bus masters must be tied together to the processor's \overline{BB} signal. Also, when an alternate master becomes bus master, it must assert \overline{BB} if it initiates a bus cycle with the \overline{TS} asserted.

The external arbiter design needs to include the function of \overline{BR} . For example, in certain cases associated with conditional branches, the MC68060 can assert \overline{BR} to request the bus from an alternate bus master, then negate \overline{BR} without using the bus, regardless of whether or not the external arbiter eventually asserts \overline{BG} . This situation happens when the MC68060 attempts to prefetch an instruction for a conditional branch. To achieve maximum performance, the processor may prefetch the instructions of the forward path for a conditional branch. If the branch prediction is incorrect and if the conditional branch results in a branch-not-taken, the previously issued branch-taken prefetch is then terminated since the prefetch

Bus Operation

is no longer needed. In an attempt to save time, the MC68060 negates \overline{BR} . If \overline{BG} takes too long to assert, the MC68060 enters a disregard request condition.

The \overline{BR} signal can be reasserted immediately for a different pending bus request, or it can stay negated indefinitely. If an external bus arbiter is designed to wait for the MC68060 to perform an active bus cycle before proceeding, then the system experiences an extended period of time in which bus arbitration is dead-locked. It must be understood that \overline{BR} is a status signal which may or may not have any relationship to \overline{BB} , \overline{BTT} , or \overline{BG} .

When using the MC68060-arbitration protocol it is possible to determine bus tenure boundaries by observing \overline{TS} and \overline{BTT} . An active bus tenure begins when a bus master asserts its \overline{TS} for the first time. Once the bus tenure has started, the active bus master must end its tenure by asserting \overline{BTT} (or a low-to-high transition of \overline{BB}). If a bus master is granted the bus, but does not start an active bus tenure by asserting \overline{TS} , no \overline{BTT} assertion (or a low-to-high transition of \overline{BB}) is needed since no bus tenure was started. When reset is applied to the entire system, \overline{TS} to all bus masters must be negated via a pullup resistor. In addition, the bus arbiter must grant the bus to a single bus master. Once the first bus master recognizes that \overline{TS} is negated and that it has been granted the bus, it asserts its \overline{TS} to establish its bus tenure and to inform other bus masters that its bus tenure has begun (this assumes that the \overline{TS} signals of all bus masters in the system are tied together). All other bus masters will therefore detect an asserted \overline{TS} (\overline{TS} is asserted by the first bus master) immediately after reset. These bus masters must then wait for \overline{BTT} to assert (or a low-to-high transition of \overline{BB}) before beginning their bus tenure when granted the bus.

Figure 7-43 illustrates an example of the processor requesting the bus from the external bus arbiter. During C1, the MC68060 asserts \overline{BR} to request the bus from the arbiter, which negates the alternate bus master's \overline{BG} signal and grants the bus to the processor by asserting \overline{BG} during C2. During C2, the alternate bus master completes its current access and relinquishes the bus in C3 by three-stating all bus signals and negating \overline{BB} and/or asserting \overline{BTT} . Typically, the \overline{BB} and \overline{BTT} signals require a pullup resistor to maintain a logic-one level between bus master tenures. The alternate bus master should negate these signals before three-stating to minimize rise time of the signals and ensure that the processor recognizes the correct level on the next BCLK rising edge. At the end of C3, the processor has already received bus grant and the alternate master has relinquished the bus. Hence, the processor assumes ownership of the bus and immediately begins a bus cycle during C4. During C6, the processor begins the second bus cycle for the misaligned operand and negates \overline{BR} since no other accesses are pending. During C7, the external bus arbiter grants the bus back to the alternate bus master that is waiting for the processor to relinquish the bus. The processor negates \overline{BB} , asserts \overline{BTT} , and three-states bus signals during C8. Finally, the alternate bus master has the bus grant. The processor has relinquished the bus at the end of C8 and is able to resume bus activity during C9. Note that \overline{BTT} is asserted only for one BCLK period and is negated for one BCLK period during C10. \overline{BTT} is then three-stated in C10.

Further note that \overline{BB} is only negated for one CLK (as opposed to BCLK) period before being three-stated, and the MC68040-arbitration protocol should not be used for full bus speed operation.

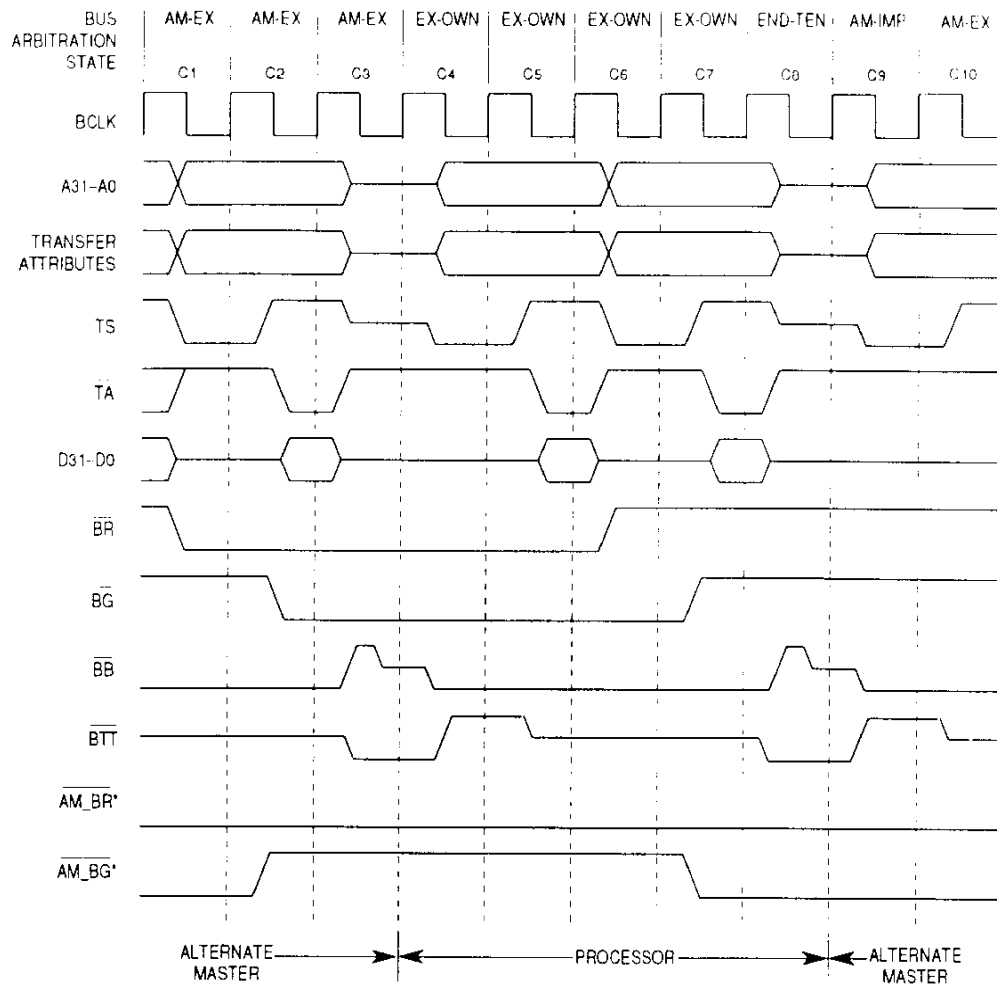

*AM indicates the alternate bus master.

Figure 7-43. Processor Bus Request Timing

Figure 7-44 illustrates a functional timing diagram for an arbitration of a relinquish and retry operation (MC68040 acknowledge termination mode). In Figure 7-44, the processor read access that begins in C1 is terminated at the end of C2 with a retry request and \overline{BG} negated, forcing the processor to relinquish the bus and allow the alternate master to access the bus. Note that the processor re-asserts \overline{BR} during C3 since the original access is pending again. After alternate bus master ownership, the bus is granted to the processor to allow it to retry the access beginning in C7.

Figure 7-45 is a functional timing diagram for implicit ownership of the bus.

Figure 7-46 illustrates the effect of \overline{BGR} on bus arbitration activity during locked sequences. When \overline{BGR} is asserted while \overline{BG} is negated, locked sequences can be broken. Otherwise, the entire locked sequence of bus cycles are completed by the processor before relinquishing the bus.

Bus Operation

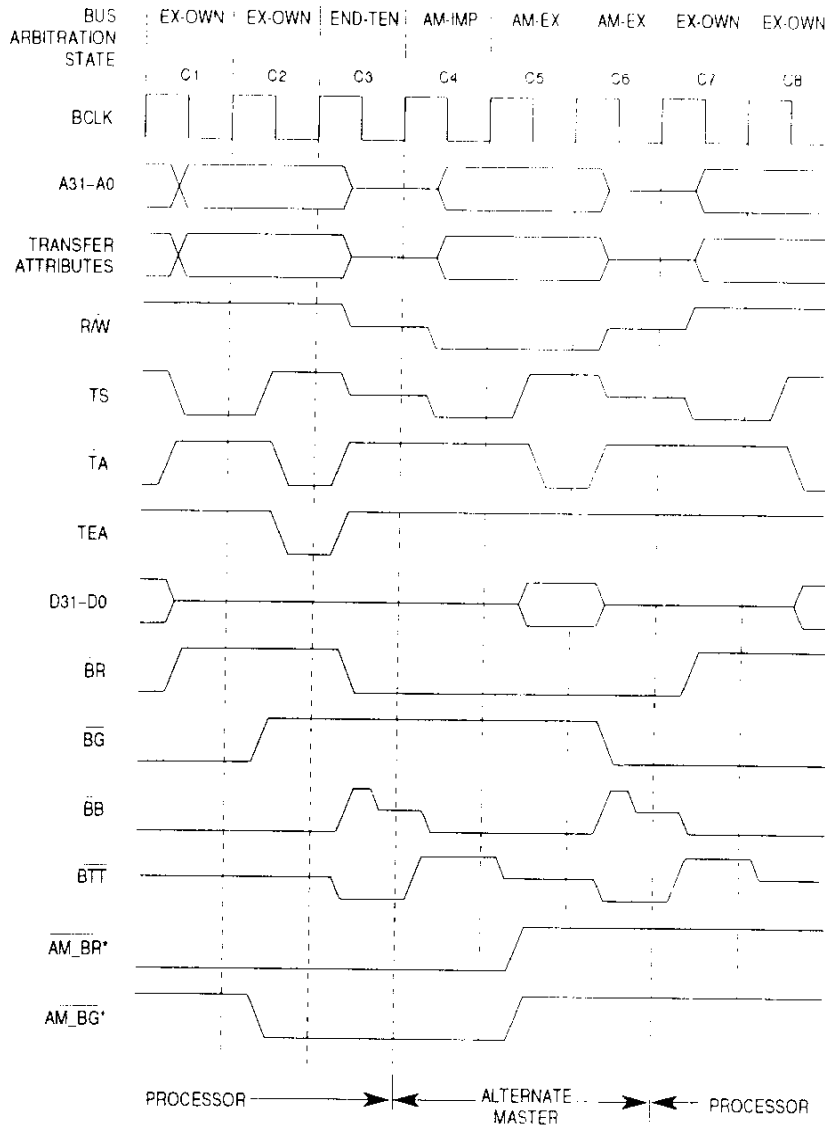

* AM indicates the alternate bus master.
 NOTE: The MC68040 acknowledge termination mode is assumed.

Figure 7-44. Arbitration During Relinquish and Retry Timing

7.12 BUS SNOOPING OPERATION

The MC68060 has the capability of monitoring bus transfers by other bus masters. The process of bus monitoring is called snooping and is controlled by the $\overline{\text{SNOOP}}$ signal.

Snooping can occur when the bus is granted to another bus master, and the MC68060 sees a $\overline{\text{TS}}$ assertion by the alternate master. If $\overline{\text{SNOOP}}$ is asserted, the processor registers the value of the A31-A0 and TT1 signals on the rising edge of BCLK in which $\overline{\text{TS}}$ is asserted.

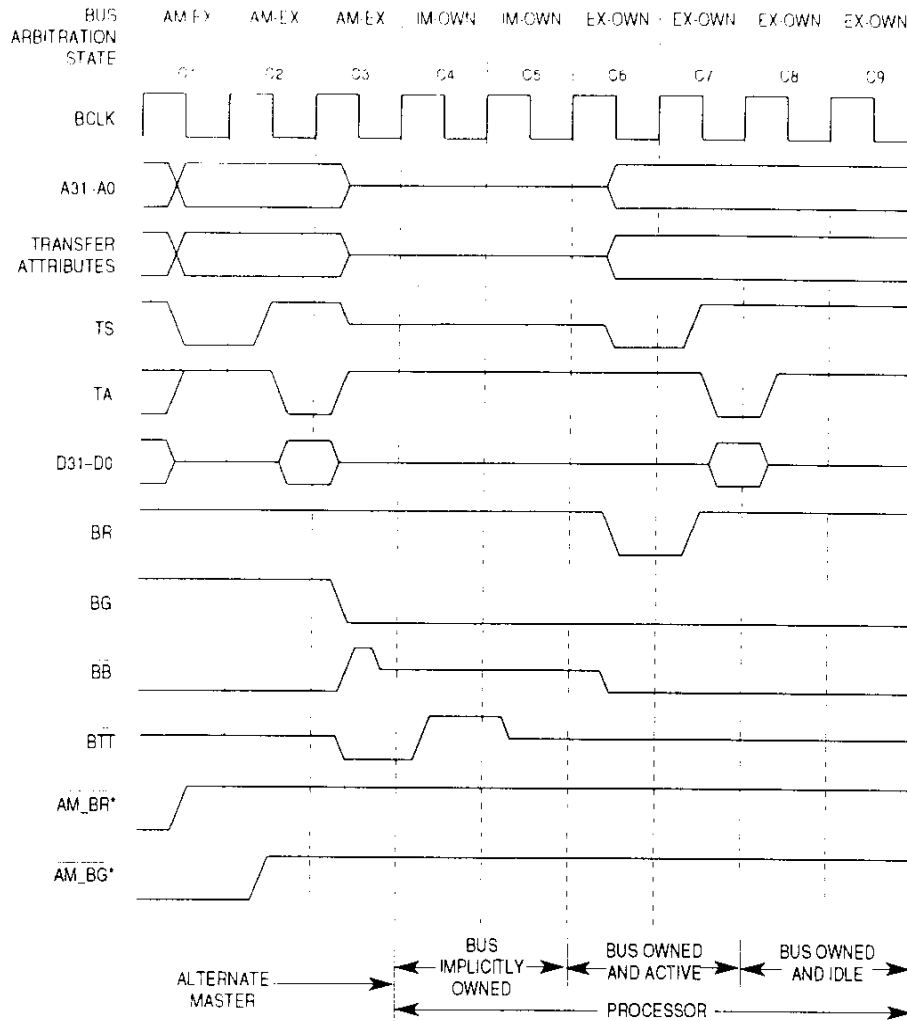

*AM indicates the alternate bus master.

Figure 7-45. Implicit Bus Ownership Arbitration Timing

In addition, the snoop address on A31–A0 is again registered on the next CLK (not BCLK) rising edge. For proper operation, the snoop addresses registered on these two separate occasions must be consistent. Only normal and MOVE16 bus transfers can be snooped. The MC68060 then examines the address of the transfer and invalidates the line in its caches in which the address matches. This process is done quietly without external indication that a cache entry has been invalidated. Note that when snooping is enabled and an entry matches in the MC68060 caches, the entry is invalidated regardless of the state of the R/W signal, transfer size, or whether or not the line has clean or dirty data. If $\overline{\text{SNOOP}}$ is negated, no snooping is done, and no lines in the caches are invalidated.

Bus Operation

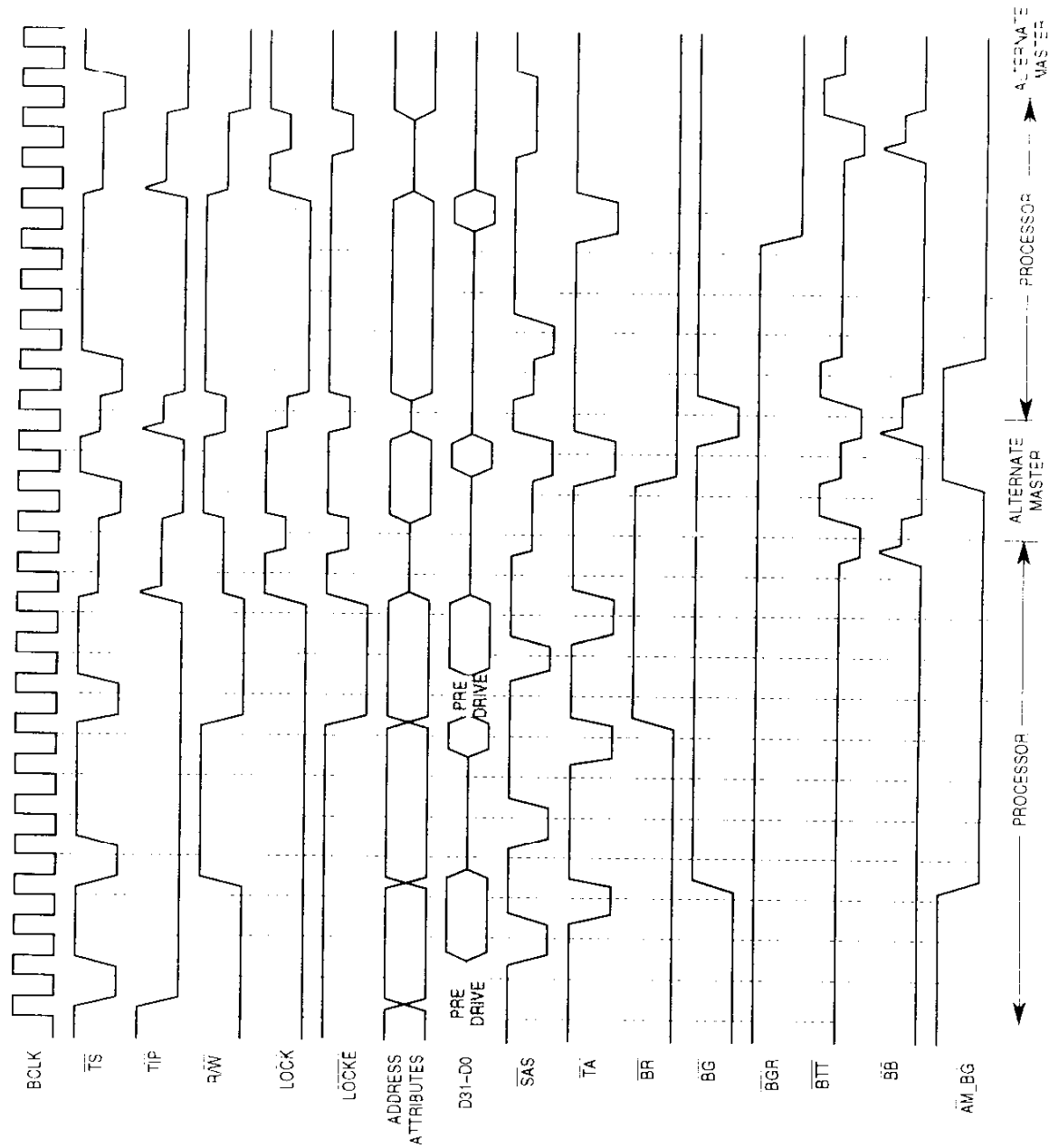
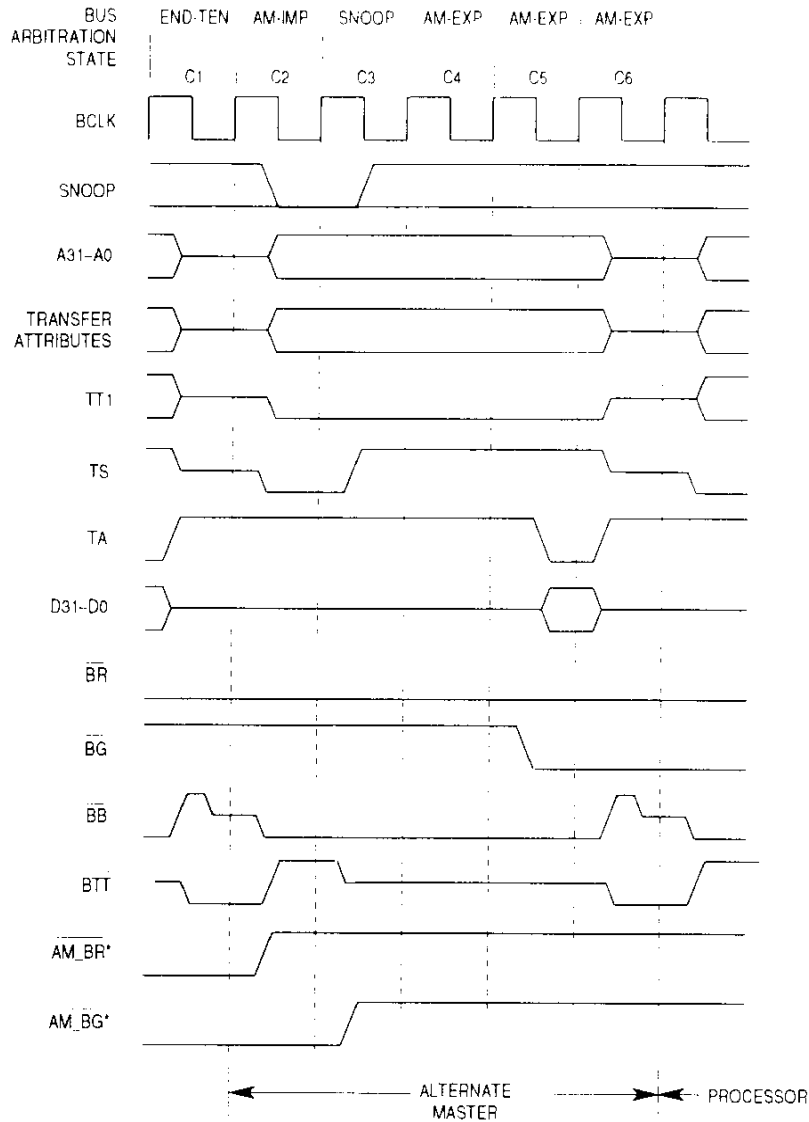

Figure 7-46. Effect of \overline{BGR} on Locked Sequences

The MC68060 does not require snooped bus cycles to be terminated with a legal transfer termination (\overline{TA} , \overline{TEA} , or \overline{TRA}). The only requirement is that \overline{TS} be asserted no more frequently than once every other BCLK edge. Figure 7-47 shows a snooped bus cycle.



*AM indicates the alternate bus master.

Figure 7-47. Snooped Bus Cycle

7.13 RESET OPERATION

An external device asserts the reset input signal (\overline{RSTI}) to reset the processor. When power is applied to the system, external circuitry should assert \overline{RSTI} for a minimum of ten BCLK cycles after V_{CC} is within tolerance. Figure 7-48 is a functional timing diagram of the power-on reset operation, illustrating the relationships among V_{CC} , \overline{RSTI} , mode selects, and bus signals. CLK is required to be stable by the time V_{CC} reaches the minimum operating specification. CLK should start oscillating as V_{CC} is ramped up in order to clear out contention internal to the part caused by the random manner in which internal flip-flops power-up. \overline{RSTI} is internally synchronized for two BCLKs before being used and must meet the specified

Bus Operation

setup and hold times to BCLK (specifications #51 and #52 in **Section 12 Electrical and Thermal Characteristics**) only if recognition by a specific BCLK rising edge is required and for configuration settings to be registered on the rising BCLK edge shown in Figure 7-48.

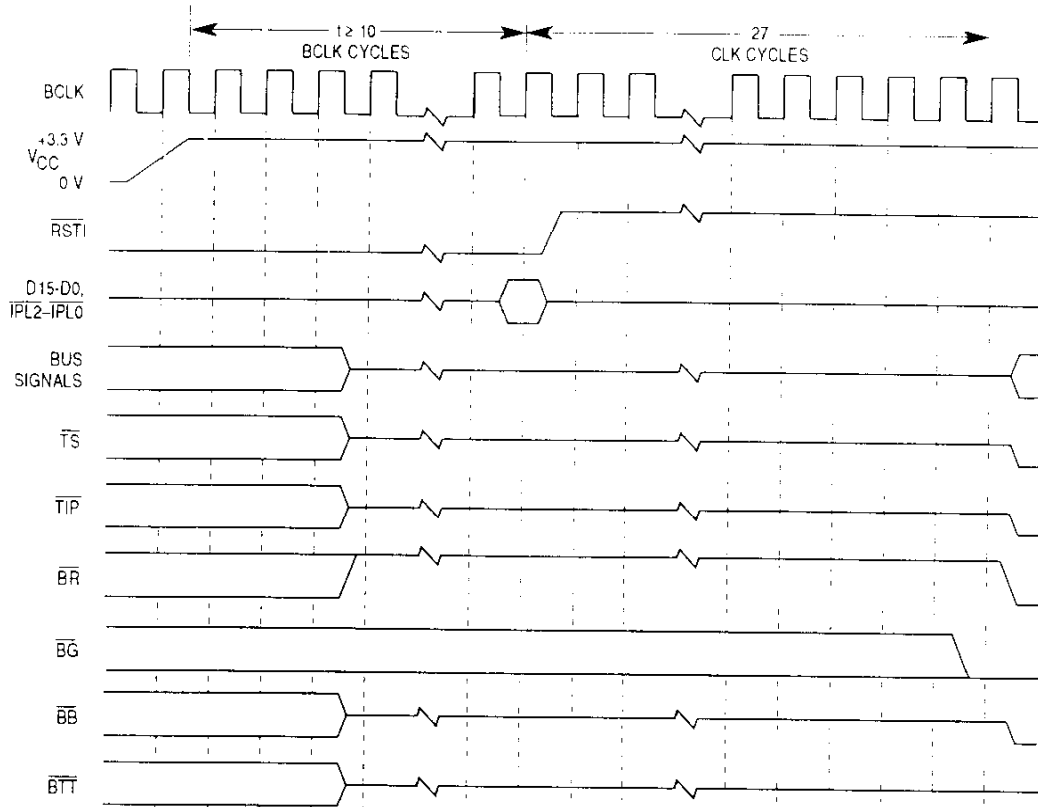

NOTE: For the processor to begin bus cycles after reset, \overline{BG} must be asserted. \overline{TS} must be negated or pulled up. If bus arbitration activity is started by an alternate master (\overline{TS} asserted), \overline{BTI} must be asserted (or \overline{BB} transition from asserted to negated) eventually to indicate an end to the alternate master's tenure.

Figure 7-48. Initial Power-On Reset Timing

\overline{TS} must be pulled up or negated during reset. Once \overline{RSTI} negates, the processor is internally held in reset for another 27 CLK cycles. During the reset period, all signals that can be, are three-stated, and the remaining signals are driven to their inactive state. Once \overline{RSTI} negates, all bus signals continue to remain in a high-impedance state until the processor is granted the bus. If \overline{BG} is negated to the processor, the bus is three-stated, and no bus cycle activity is present until \overline{BG} is asserted. Afterwards, the first bus cycle for reset exception processing begins. In Figure 7-48 the processor assumes implicit bus ownership on reset before the first bus cycle begins. The levels on \overline{IPLx} and D15–D0 are used to selectively enable the special modes of operation when \overline{RSTI} is negated. These signals are registered into the processor on the last rising edge of BCLK in which \overline{RSTI} is sampled low. These signals should be driven to their normal levels before the end of the 27-CLK internal reset period.

For processor resets after the initial power-on reset, \overline{RSTI} should be asserted for at least ten BCLK periods. Figure 7-49 illustrates timings associated with a reset when the processor is executing bus cycles. \overline{BB} and \overline{TIP} are negated before transitioning to a three-state level.

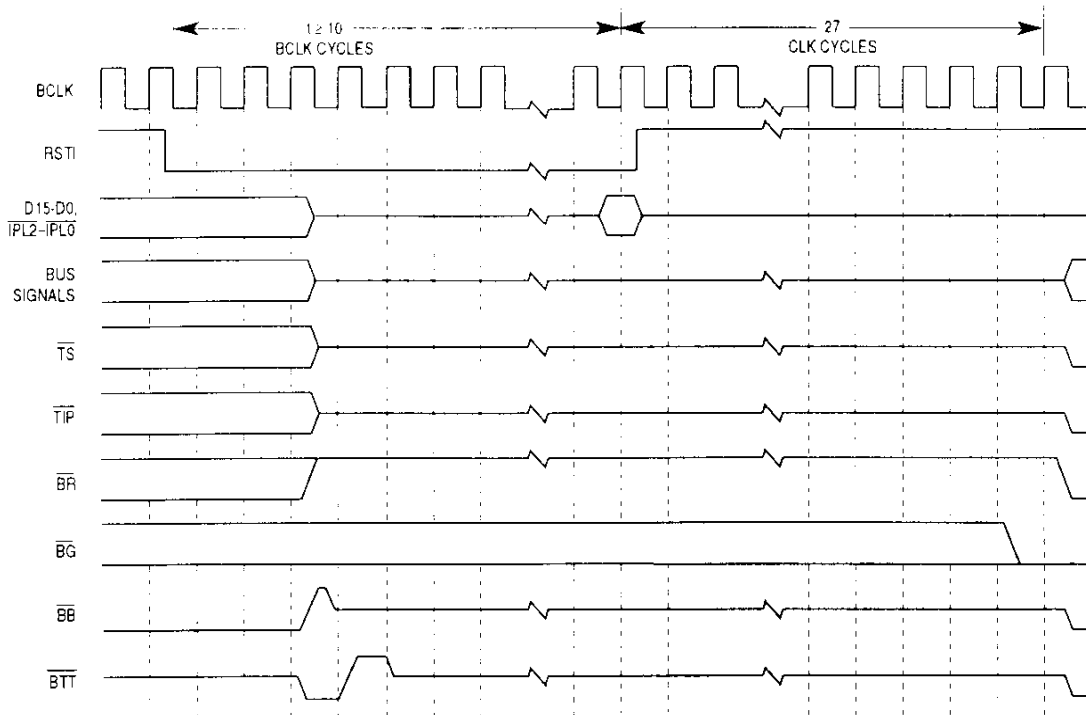

NOTE: For the processor to reset begin bus cycles after reset, \overline{BG} must be asserted, \overline{TS} must be negated or pulled up. \overline{BTT} must be asserted (or \overline{BTT} transition from asserted to negated) eventually to indicate an end to the alternate master's tenure.

Figure 7-49. Normal Reset Timing

Resetting the processor causes any bus cycle in progress to terminate as if \overline{TEA} had been asserted. In addition, the processor initializes registers appropriately for a reset exception. **Section 8 Exception Processing** describes reset exception processing. When a RESET bus operation instruction is executed, the processor drives the reset out (\overline{RSTO}) signal for 512 CLK cycles. In this case, the processor can be used to reset external devices in a system, and the internal registers of the processor are unaffected. The external devices connected to the \overline{RSTO} signal are reset at the completion of the RESET instruction. An \overline{RSTI} signal that is asserted to the processor during execution of a RESET instruction immediately resets the processor and causes the \overline{RSTO} signal to negate. \overline{RSTO} can be logically ANDed with the external signal driving \overline{RSTI} to derive a system reset signal that is asserted for both an external processor reset and execution of a RESET instruction.

7.14 SPECIAL MODES OF OPERATION

The MC68060 supports the following three operation modes, which are selectively enabled during processor reset and remain in effect until the next processor reset. Refer to **7.13 Reset Operation** for reset timing information. Table 7-10 summarizes the three special modes and associates them with the appropriate \overline{IPLx} signal.

Table 7-10. Special Mode vs. \overline{IPLx} Signals

Signal	Value During Reset Time	Action
$\overline{IPL2}$	Asserted	Extra Data Write Hold Mode Enabled
	Negated	Extra Data Write Hold Mode Disabled
$\overline{IPL1}$	Asserted	Native-MC68060 Acknowledge Termination Protocol
	Negated	MC68040 Acknowledge Termination Protocol
$\overline{IPL0}$	Asserted	Acknowledge Termination Ignore State Capability Enabled
	Negated	Acknowledge Termination Ignore State Capability Disabled

7.14.1 Acknowledge Termination Ignore State Capability

The MC68060 provides acknowledge termination ignore state capability to make high-frequency system design easier. This feature defines BCLK edges during which the acknowledge termination signals (\overline{TA} , \overline{TEA} , and \overline{TRA}) are ignored. This feature is enabled if $\overline{IPL0}$ is asserted during reset.

During reset, 16 bits of information (from D15–D0) are registered into the MC68060. These 16 bits define four values of four bits each. Two of the four values are used for read bus cycles; the other two values are used for write bus cycles. For the read bus cycle, the first value is the primary ignore state count value. The primary ignore state count value is used during the first long-word transfer of a line transfer cycle, or the only data transfer for byte, word, or long-word bus cycles. The second value is the secondary ignore state count value. The secondary ignore state count value is used during the next three long words for line transfer cycles, after the first long word has been transferred. Similarly, the two values of the write bus cycle are defined as a primary ignore state count value and a secondary ignore state count value, respectively. Figure 7-50 shows the assignment of the four data nibbles at reset.

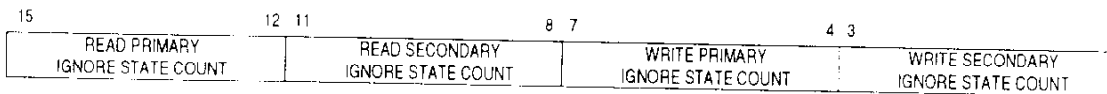

Figure 7-50. Data Bus Usage During Reset

At the beginning of a bus cycle, the appropriate primary ignore state count value is loaded into an internal counter. The counter decrements every BCLK rising edge. As long as the counter has a non-zero count value, the MC68060 ignores the acknowledge termination signals. Once the counter reaches zero, the MC68060 asserts \overline{SAS} for one BCLK period and begins to sample the acknowledge termination signals and acts accordingly. For byte, word, or long-word transfers, the bus cycle ends when a valid termination is detected. For line transfer cycles after the first long-word transfer, the secondary ignore state count value is

loaded into the internal counter and the counter decrements every rising BCLK edge. As long as the counter has a non-zero count value, the MC68060 ignores the acknowledge termination signals. Once the counter reaches zero, the MC68060 asserts \overline{SAS} for one BCLK period and begins to sample the acknowledge termination signals and acts accordingly. This process repeats for the rest of the line transfer cycle.

To aid in system debug for system designs that continuously assert \overline{TA} , a status signal, \overline{SAS} , is provided to indicate which rising BCLK edge the MC68060 begins to sample acknowledge termination signals. \overline{SAS} is negated on the next rising BCLK edge if the bus cycle ends or if the next ignore state count value is non-zero. Aside from being a status signal, \overline{SAS} may be used in conjunction with some decode address bits to generate the \overline{CLA} signal or \overline{TA} signal shown in Figure 7-24.

Figure 7-51 shows an example of how the MC68060 behaves when the acknowledge termination ignore state mode is enabled. In this example, the read primary ignore state count value and the read secondary ignore state count value are initialized to a value of one during reset. On the first long-word access, \overline{TA} is asserted immediately, but data is not registered until the rising edge of C4. On the next long-word access, the secondary count value takes effect. In a similar manner, \overline{TA} is ignored until the rising edge of C6. On the last long-word access of the line, the secondary ignore state count expires before \overline{TA} is asserted. Therefore, more wait states are added until \overline{TA} is asserted and recognized on the rising edge of C12.

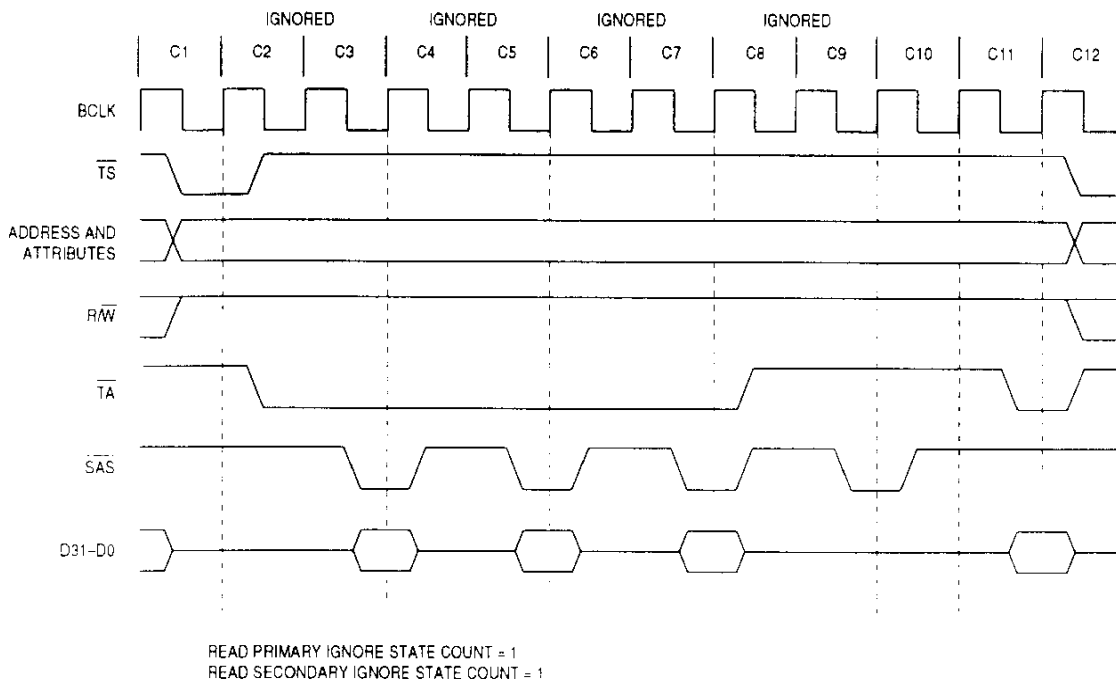

Figure 7-51. Acknowledge Termination Ignore State Example

Bus Operation

The ignore state settings can be used to make the system design of the acknowledge termination logic simpler than in existing MC68040 systems that required these signals to be valid (either asserted or negated) about every rising BCLK edge. Thus, using the acknowledge termination ignore state capability allows the use of slower ASICs and PALs to be used for generating the acknowledge termination signals without the requirement that these signals be at a valid logic level about every rising BCLK edge.

7.14.2 Acknowledge Termination Protocol

The MC68060 provides system designers a choice of using either the MC68040 acknowledge termination protocol or the native-MC68060 acknowledge termination protocol. The native-MC68060 acknowledge termination protocol is chosen if $\overline{\text{IPL1}}$ is asserted during reset.

The MC68040 acknowledge termination protocol is provided for MC68040 compatibility. In this protocol, a retry is indicated by having both $\overline{\text{TA}}$ and $\overline{\text{TEA}}$ asserted simultaneously. In this mode, the $\overline{\text{TRA}}$ signal must be pulled up at all times. Refer to Table 7-4 and Table 7-5 for details on acknowledge termination signal encoding.

The native-MC68060 acknowledge termination protocol is provided to aid in high-frequency designs. The signal $\overline{\text{TRA}}$ is used to indicate a retry operation, as opposed to using a combination of $\overline{\text{TA}}$ and $\overline{\text{TEA}}$ to indicate a retry. Refer to Table 7-4 and Table 7-5 for details on the native-MC68060 acknowledge termination signal encoding.

7.14.3 Extra Data Write Hold Time Mode

In this mode, the MC68060 holds the contents of the data bus valid during a write bus cycle for an extra BCLK period after a valid $\overline{\text{TA}}$ is sampled. This mode is enabled if $\overline{\text{IPL2}}$ is asserted during reset. When this mode is enabled, a zero wait state burst bus cycle is not possible and systems must be designed to insert wait states on burst accesses. Figure 7-52 shows an example of a line transfer cycle with this mode enabled. Read cycles are unaffected by this mode.

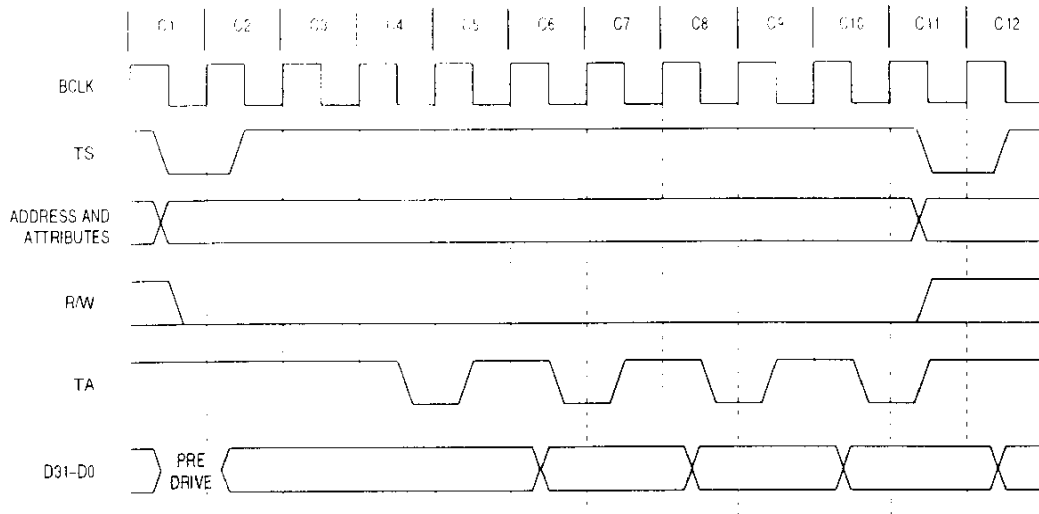

Figure 7-52. Extra Data Write Hold Example



SECTION 8 EXCEPTION PROCESSING

Exception processing is the activity performed by the processor in preparing to execute a special routine for any condition that causes an exception. Exception processing does not include execution of the routine itself. This section describes the processing for each type of integer unit exception, exception priorities, the return from an exception, and bus fault recovery. This section also describes the formats of the exception stack frames. For details on floating-point exceptions refer to **Section 6 Floating-Point Unit**.

8.1 EXCEPTION PROCESSING OVERVIEW

Exception processing is the transition from the normal processing of a program to the processing required for any special internal or external condition that preempts normal processing. External conditions that cause exceptions are interrupts from external devices, bus errors, and resets. Internal conditions that cause exceptions are instructions, address errors, and tracing. For example, the TRAP, TRAPcc, CHK, RTE, DIV, and FDIV instructions can generate exceptions as part of their normal execution. In addition, illegal instructions, unimplemented integer instructions, unimplemented effective addresses, unimplemented floating-point instructions and data types, and privilege violations cause exceptions. Exception processing uses an exception vector table and an exception stack frame. The following paragraphs describe the vector table and a generalized exception stack frame.

The MC68060 uses a restart exception processing model. Exceptions are recognized at the execution stage of the operand execution pipeline (OEP) and force later instructions that have not yet reached that stage to be aborted.

Instructions that cannot be interrupted, such as those that generate locked bus transfers or access noncacheable precise pages, are allowed to complete before exception processing begins, unless an access error prevents this instruction from completing.

Exception processing occurs in four functional steps. However, all individual bus cycles associated with exception processing (vector acquisition, stacking, etc.) are not guaranteed to occur in the order in which they are described in this section. Figure 8-1 illustrates a general flowchart for the steps taken by the processor during exception processing.

During the first step, the processor makes an internal copy of the status register (SR). Then the processor changes to the supervisor mode by setting the S-bit and inhibits tracing of the exception handler by clearing the T-bit in the SR. For the reset and interrupt exceptions, the processor also updates the interrupt priority mask in the SR.

During the second step, the processor determines the vector number for the exception. For interrupts, the processor performs an interrupt acknowledge bus cycle to obtain the vector

Exception Processing

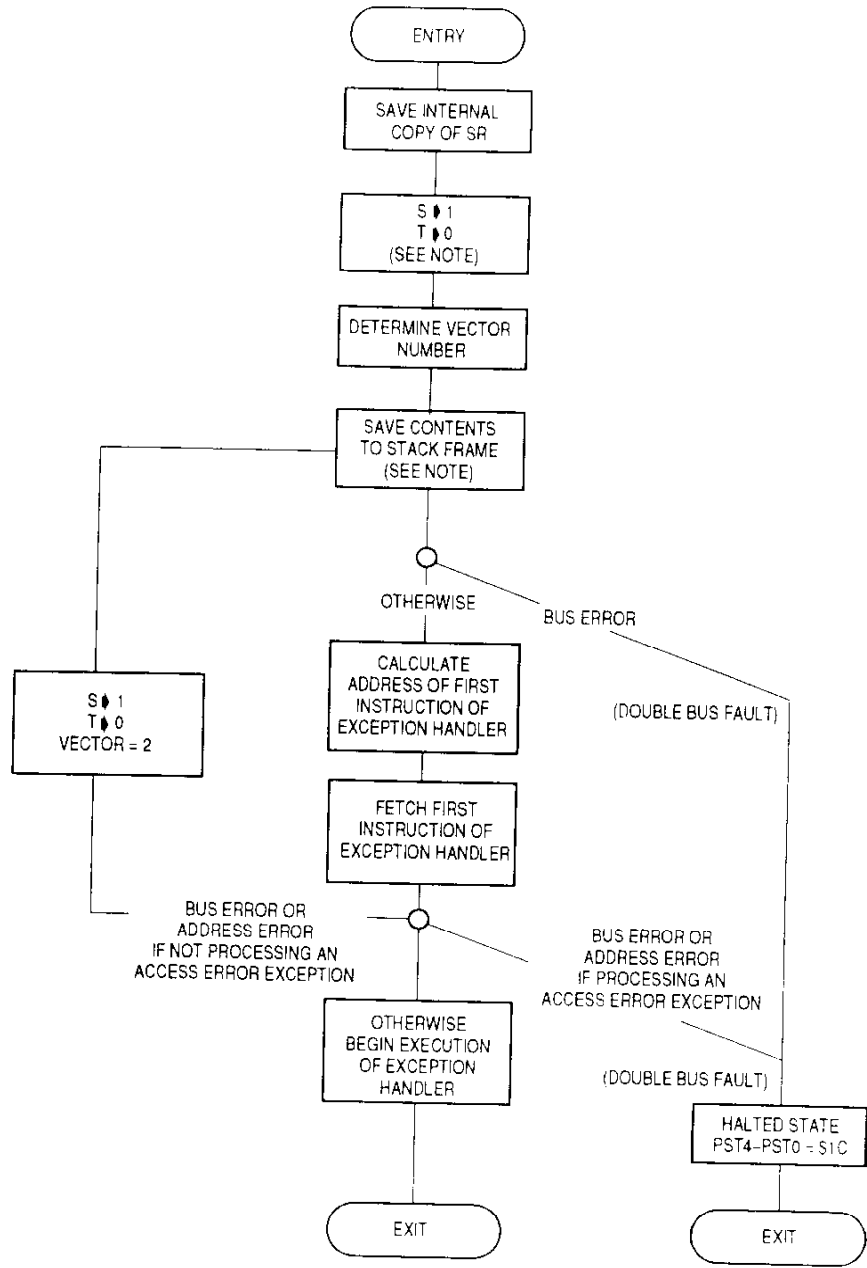

NOTE: THESE BLOCKS VARY FOR RESET AND INTERRUPT EXCEPTIONS.

Figure 8-1. General Exception Processing Flowchart

number. For all other exceptions, internal logic provides the vector number. This vector number is used in the last step to calculate the address of the exception vector. Throughout this section, vector numbers are given in decimal notation.

The third step is to save the current processor contents for all exceptions other than reset. The processor creates one of four exception stack frame formats on the supervisor stack and fills it with information appropriate for the type of exception. Other information can also be stacked, depending on which exception is being processed and the state of the processor prior to the exception. Figure 8-2 illustrates the general form of the exception stack frame.

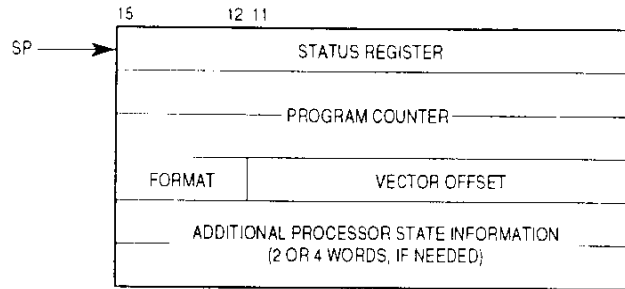

Figure 8-2. General Form of Exception Stack Frame

The last step involves the determination of the address of the first instruction of the exception handler and then passing control to the handler. The processor multiplies the vector number by four to determine the exception vector offset. It adds the offset to the value stored in the vector base register (VBR) to obtain the memory address of the exception vector. Next, the processor loads the program counter (PC) (and the supervisor stack pointer (SSP) for the reset exception) from the exception vector table entry with the address of the first instruction of the exception handler. The processor then fetches this instruction and initiates exception handling. At the conclusion of exception handling, the processor resumes normal processing at the address in the PC.



The MC68060 is unique from earlier members of the family in that if an interrupt is pending during exception processing, the exception processing for that interrupt is deferred until the first instruction of the exception handler of the current exception is executed. This allows any exception handler to mask interrupts by ensuring that the first instruction of the exception handler is an SR write that raises the interrupt level.

Normally, the end of an exception handler contains an RTE instruction. When the processor executes the RTE instruction, it examines the stack frame on top of the supervisor stack to determine if it is a valid frame. If the processor determines that it is a valid frame, the SR and PC fields are loaded from the exception frame and control is passed to the specified instruction address.

All exception vectors are located in the supervisor address space and are accessed using data references. Only the initial reset vector is fixed in the processor's memory map; once initialization is complete, there are no fixed assignments. Since the VBR provides the base address of the exception vector table, the exception vector table can be located anywhere in memory; it can even be dynamically relocated for each task that an operating system executes.

Exception Processing

The MC68060 supports a 1024-byte vector table containing 256 exception vectors (see Table 8-1). Motorola defines the first 64 vectors and reserves the other 192 vectors for user-defined interrupt vectors. External devices can use vectors reserved for internal purposes at the discretion of the system designer. External devices can also supply vector numbers for some exceptions. External devices that cannot supply vector numbers use the autovector capability, which allows the MC68060 to automatically generate a vector number.

Table 8-1. Exception Vector Assignments

Vector Number(s)	Vector Offset (Hex)	Stack Frame Format	Stacked Program Counter*	Assignment
0	000	---	---	Reset Initial SSP
1	004	---	---	Reset Initial PC
2	008	4	---	Access Fault
3	00C	2	fault	Address Error
4	010	0	fault	Illegal Instruction
5	014	2	next	Integer Divide-by-Zero
6	018	2	next	CHK, CHK2 Instructions
7	01C	2	next	TRAPcc, TRAPV Instructions
8	020	0	fault	Privilege Violation
9	024	2	next	Trace
10	028	0	fault	Line 1010 Emulator (Unimplemented A-Line Opcode)
11	02C	0	fault	Line 1111 Emulator (Unimplemented F-Line Opcode)
11	02C	2	next	Floating-Point Unimplemented Instruction
11	02C	4	next	Floating-Point Disabled
12	030	0	next	Emulator Interrupt
13	034	0	---	Defined for MC68020 and MC68030, not used by MC68060
14	038	0	fault	Format Error
15	03C	0	next	Uninitialized Interrupt
16-23	040-05C	---	---	(Unassigned, Reserved)
24	060	0	next	Spurious Interrupt
25	064	0	next	Level 1 Interrupt Autovector
26	068	0	next	Level 2 Interrupt Autovector
27	06C	0	next	Level 3 Interrupt Autovector
28	070	0	next	Level 4 Interrupt Autovector
29	074	0	next	Level 5 Interrupt Autovector
30	078	0	next	Level 6 Interrupt Autovector
31	07C	0	next	Level 7 Interrupt Autovector
32-47	080-0BC	0	next	TRAP #0-15 Instruction Vectors
48-55	0C0-0DC	---	---	Floating-Point Exceptions†
56	0E0	---	---	Defined for MC68030 and MC68851, not used by MC68060
57	0E4	---	---	Defined for MC68851, not used by MC68060
58	0E8	---	---	Defined for MC68851, not used by MC68060
59	0EC	---	---	(Unassigned, Reserved)
60	0F0	0	fault	Unimplemented Effective Address
61	0F4	0	fault	Unimplemented Integer Instruction
62-63	0F8-0FC	---	---	(Unassigned, Reserved)
64-255	100-3FC	0	next	User Defined Vectors (192)

*For the Access Fault exception, refer to **8.4.4.1 Program Counter (PC)**.

"fault" refers to the PC of the instruction that caused the exception.

"next" refers to the PC of the next instruction that follows the instruction that caused the fault.

† Refer to **Section 6 Floating-Point Unit**.

8.2 INTEGER UNIT EXCEPTIONS

The following paragraphs describe the external interrupt exceptions and the different types of exceptions generated internally by the MC68060 integer unit. The following exceptions are discussed:

- Access Error
- Address Error

- Instruction Trap
- Illegal and Unimplemented Instruction Exceptions
- Privilege Violation
- Trace
- Format Error
- Breakpoint Instruction
- Interrupt
- Reset

8.2.1 Access Error Exception

An access error exception occurs when a bus cycle is terminated with \overline{TEA} (\overline{TA} must be negated if in MC68040 acknowledge termination mode) asserted externally or an internal access error.

An external access error (bus error) occurs when external logic aborts a bus cycle and asserts the \overline{TEA} input signal (\overline{TA} must be negated if in MC68040 acknowledge termination mode).

A bus error on an operand write access always results in an access error exception, causing the processor to begin exception processing. However, the time of reporting this bus error is a function of the instruction type and/or memory mapping of the destination pages. For writes that are precise (this includes certain atomic instructions like TAS and CAS and references to pages marked noncacheable precise), the occurrence of a bus error causes the pipeline to be aborted immediately and initiates exception processing. For writes that are imprecise (stored in push or store buffers or reference to pages marked noncacheable imprecise), the actual bus cycle is decoupled from the instruction which generated the access. For these types of bus errors, the exception is taken, but the state of the processor may be advanced from the actual instruction which generated the write.

For operand read accesses generating non-line-sized references, a bus error causes the pipeline to be immediately aborted and initiates exception processing. This is also true if a bus error occurs on the first transfer of a line-sized transfer. For a bus error that occurs on the second, third, or fourth transfers of a line access, the line is not allocated in the cache and no exception is reported. If a subsequent instruction references another operand within the given line, another system bus cycle is generated and the bus error reported at that time (i.e., as the subsequent reference receives a bus error on its initial transfer) and the exception is then taken.

Bus errors that are signaled during instruction prefetches are deferred until the processor attempts to execute that instruction. At that time, the bus error is signaled and exception processing is initiated. If a bus error is encountered during an instruction prefetch cycle, but the corresponding instruction is never executed due to a change-of-flow in the instruction stream, the bus error is discarded.

Exception Processing

When the MC68060 detects any exception, the pipelines are aborted and exception processing is initiated. After performing the SR copy and forcing the processor into the supervisor mode, the processor then performs a pipeline synchronization to all the push and store buffers to empty before proceeding with the exception. If a buffer bus error is signaled at this time, the pipeline discards the original fault and instead reports the access error caused by the first buffer write bus error (subsequent write buffer bus errors are ignored). Once the push and store buffers are empty, the exception processing continues.

Processor accesses for either data or instructions can result in internal access errors. Internal access errors must be corrected to complete execution of the current instruction. An internal access error occurs when the data or instruction memory management unit (MMU) detects that a successful address translation is not possible because the page is write protected, supervisor only, or nonresident. When the instruction or data MMU detects that a successful address translation is not possible, the instruction that initiated the unsuccessful address translation is marked with an MMU fault and is continued down the pipeline. This fault detection is independent of whether or not a table search was required. Some MMU faults such as the supervisor-protect and write-protect faults can occur on address translation cache (ATC) hits or table searches. All other MMU faults can only occur on ATC misses on the subsequent table searches. If this instruction that is marked with an MMU fault reaches the EX stage of the OEP, an access error exception is reported.

As illustrated in Figure 8-1, the processor begins exception processing for an access error by making an internal copy of the current SR. The processor then enters the supervisor mode and clears the T-bit. The processor generates exception vector number 2 for the access error vector. It saves the vector offset, PC, and internal copy of the SR on the stack. In addition, the faulting logical address and the fault status long word (FSLW) is saved on the stack.

A stack frame format of type 4 is generated when access error exception is reported. The stacked PC is the logical address of the instruction executing at the time the fault was detected. Note that this instruction is the instruction that initiated the bus cycle for all access error cases, except for bus errors on write buffer (push or store) bus cycles. The logical address that caused the fault is saved in the address field on the stack frame. Note that if the fault occurred on the second or later of a misaligned access, the logical address may need to be adjusted to point to the logical address that caused the access error. A fault status long word is also provided in the stack to further qualify the conditions that caused the fault.

If a bus error occurs during the exception processing for an access error, address error, or reset, a double bus fault occurs, and the processor enters the halted state as indicated by the PST4–PST0 encoding \$1C. In this case, the processor does not attempt to alter the current state of memory. Only an external reset can restart a processor halted by a double bus fault.

The supervisor stack has special requirements to ensure that exceptions can be stacked. The stack must be resident with correct protection in the direction of growth to ensure that exception stacking never has a bus error or internal access error. Memory pages allocated to the stack that are higher in memory than the current stack pointer can be nonresident

since an RTE or FRESTORE instruction can check for residency and trap before restoring the state.

A special case exists for systems that allow arbitration of the processor bus during locked transfer sequences. If the arbiter can signal a bus error of a locked translation table update due to an improperly broken lock, any pages touched by exception stack operations must have the U-bit set in the corresponding page descriptor to prevent the occurrence of the locked access during translation table searches.

8.2.2 Address Error Exception

An address error exception occurs when the processor attempts to prefetch an instruction from an odd address. An odd address is defined as an address in which the least significant bit is set. Some of the ways an address error exception is taken is as follows: RTS, RTD, RTR, or RTE in which the PC value in the stack is odd; a branch (conditional or unconditional), jump, or subroutine call in which the branch target address is odd; and an odd vector table entry (e.g., an odd reset vector).

A stack frame of type 2 is generated when this exception is reported. The stacked PC contains the address of the instruction that caused the address error. The address field in the stack contains the branch target address with A0 cleared.

If an address error occurs during the exception processing for a bus error, address error, or reset, a double bus fault occurs. The processor enters the halted state as indicated by the PST4–PST0 encoding \$1C. In this case, the processor does not attempt to alter the current state of memory. Only an external reset can restart a processor halted by a double bus fault.

8.2.3 Instruction Trap Exception

Certain instructions are used to explicitly cause trap exceptions. The TRAP #n instruction always forces an exception and is useful for implementing system calls in user programs. The TRAPcc, TRAPV, and CHK instructions force exceptions if the user program detects an error, which can be an arithmetic overflow or a subscript value that is out of bounds. The DIVS and DIVU instructions force exceptions if a division operation is attempted with a divisor of zero.

As illustrated in Figure 8-1, when a trap exception occurs, the processor internally copies the SR, enters the supervisor mode, and clears the T-bit. The processor generates a vector number according to the instruction being executed. Vector 5 is for DIVx, vector 6 is for CHK, and vector 7 is for TRAPcc and TRAPV instructions. For the TRAP #n instruction, the vector number is 32 plus n. The stack frame saves the trap vector offset, the PC, and the internal copy of the SR on the supervisor stack.

A stack frame of type 0 is generated when a TRAP #n exception is taken. The saved value of the PC is the logical address of the instruction following the instruction that caused the trap. Instruction execution resumes at the address in the exception vector after the required instruction is prefetched.

Exception Processing

For all instruction traps other than TRAP #n, a stack frame of type 2 is generated. The stacked PC contains the logical address of the next instruction to be executed. In addition to the stacked PC, a pointer to the instruction that caused the trap is saved in the address field of the stack frame. Instruction execution resumes at the address in the exception vector after the required instruction is prefetched.

8.2.4 Illegal Instruction and Unimplemented Instruction Exceptions

There are eight unimplemented instruction exceptions: unimplemented integer, unimplemented effective address, unimplemented A-line, unimplemented F-line, floating-point disabled, floating-point unimplemented instruction, floating-point unsupported data type, and illegal instruction.

The unimplemented integer exception corresponds to vector number 61 and occurs when the processor attempts to execute an instruction that contains a quad word operand (MULx producing a 64-bit product and DIVx using a 64-bit dividend), CAS2, CHK2, CMP2, CAS with a misaligned operand, and the MOVEP instruction. A stack frame of type 0 is generated when this exception is reported. The stacked PC points to the logical address of the unimplemented integer instruction that caused the exception.

8

The unimplemented effective address exception corresponds to vector number 60, and occurs when the processor attempts to execute any floating-point instruction that contains an extended precision immediate source operand (F<op>, #imm,FPx), when the processor attempts to execute an FMOVEM.L #imm,<control register list> instruction of more than one floating-point control register (FPCR, FPSR, FPIAR), when the processor attempts an FMOVEM.X instruction using a dynamic register list (FMOVEM.X Dn,<ea> or FMOVEM.X,<ea>,Dn). The stack frame of type 0 is generated when this exception is reported. The stacked PC points to the logical address of the instruction that caused the exception. The FPIAR is unaffected. Refer to **Section 6 Floating-Point Unit** for details.

An unimplemented A-line exception corresponds to vector number 10 and occurs when an instruction word pattern begins (bits 15–12) with \$A. The A-line opcodes are user-reserved, and Motorola will not use any A-line instructions to extend the instruction set of any of Motorola's processors. A stack frame of format 0 is generated when this exception is reported. The stacked PC points to the logical address of the A-line instruction word.

A floating-point unsupported data type exception occurs when the processor attempts to execute a bit pattern that it recognizes as an MC68881 instruction, the floating-point unit (FPU) is enabled via the processor configuration register (PCR), the floating-point instruction is implemented, but the floating-point data type is not implemented in the MC68060 FPU. This exception corresponds to vector number 55. A stack frame of type 0, 2, or 3 is generated when this exception is reported. The stacked PC points to the logical address of next instruction after the floating-point instruction. Refer to **Section 6 Floating-Point Unit** for details.

A floating-point unimplemented instruction exception occurs when the processor attempts to execute an instruction word pattern that begins with \$F, the processor recognizes this bit pattern as an MC68881 instruction, the FPU is enabled via the PCR, but the floating-point instruction is not implemented in the MC68060 FPU. This exception corresponds to vector

number 11 and shares this vector with the floating-point disabled and the unimplemented F-line exceptions. A stack frame of type 2 is generated when this exception is reported. The stacked PC points to the logical address of the next instruction after the floating-point instruction. Refer to **Section 6 Floating-Point Unit** for details.

A floating-point disabled exception occurs when the processor attempts to execute an instruction word pattern that begins with \$F, the processor recognizes this bit pattern as an MC68881 instruction, but the FPU is disabled via the PCR, or if the processor is an MC68LC060 or an MC68EC060. This exception corresponds to vector number 11 and shares this vector with the floating-point unimplemented and the F-line Unimplemented exceptions. A type 4 stack frame is generated when this exception is reported. The stacked PC points to the logical address of the next instruction. The PC of the faulted instruction field (SP+12) points to the floating-point instruction that needs to be emulated.

The effective address field (SP+8) contains the effective address of the source or destination of the memory operand for the floating-point instruction. This field is valid only if the floating-point instruction references a memory operand. If the operand is in a register (either floating-point or data register), the effective address field contains \$0. For the (An)+ and -(An) addressing modes, the address register is not modified by the processor, and it is the responsibility of the third party emulation software to modify the An value before returning to the user program. For the -(An) addressing mode, the value of the effective address field contains the address of the first memory operand except if the operand size is extended precision. For the extended precision case, the effective address field contains An-4 instead of An-12. This is a key difference between the MC68LC/EC060 and the MC68LC/EC040 stack frame, and third-party software emulators written for the MC68LC/EC040 must account for this difference.

An unimplemented F-line exception occurs when an instruction word pattern begins (bits 15-12) with \$F, the MC68060 does not recognize it as a valid F-line instruction (e.g., PTEST), and the processor does not recognize it as a floating-point MC68881 instruction. This exception corresponds to vector number 11 and shares this vector with the floating-point unimplemented instruction and the floating-point disabled exceptions. A stack frame of type 0 is generated by this exception. The stacked PC points to the logical address of the F-line word.

If the processor encounters any other instruction word bit patterns that are not implemented by the MC68060, and is not covered by one of the other six unimplemented instruction exceptions, the illegal instruction exception is taken. The illegal instruction exception corresponds to vector number 4. An illegal instruction exception is also taken after a breakpoint acknowledge bus cycle is terminated, either by the assertion of the transfer acknowledge (\overline{TA}) or the transfer error acknowledge (\overline{TEA}) signal. An illegal instruction exception can also be a MOVEC instruction with an undefined register specification field in the first extension word. The M68000 instruction set defines the opcode \$4AFC as an ILLEGAL instruction. This exception is also taken when that opcode is executed. A stack frame of type 0 is generated when this exception is taken. The stacked PC points to the logical address of the illegal instruction that caused the exception.

Exception Processing

Exception processing for illegal and unimplemented instructions is similar to that for instruction traps. When the processor has identified an illegal or unimplemented instruction, it initiates exception processing instead of attempting to execute the instruction. The processor copies the SR, enters the supervisor mode, and clears T-bit, disabling further tracing. The processor generates the vector number according to the exception type. The illegal or unimplemented instruction vector offset, current PC, and copy of the SR are saved on the supervisor stack. Instruction execution resumes at the address contained in the exception vector.

8.2.5 Privilege Violation Exception

To provide system security, certain instructions are privileged. An attempt to execute one of the following privileged instructions while in the user mode causes a privilege violation exception:

ANDI to SR	FSAVE	MOVEC	PLPA
CINV	MOVE from SR	MOVES	RESET
CPUSH	MOVE to SR	ORI to SR	RTE
EORI to SR	MOVE USP	PFLUSH	STOP
FRESTORE	LPSTOP		

8

Exception processing for privilege violations is similar to that for illegal instructions. When the processor identifies a privilege violation, it begins exception processing before executing the instruction. As illustrated in Figure 8-1, the processor copies the SR, enters the supervisor mode, and clears the T-bit. The processor generates vector number 8, saves the privilege violation vector offset, the current PC value, and the internal copy of the SR on the supervisor stack. The saved value of the PC is the logical address of the first word of the instruction that caused the privilege violation. Instruction execution resumes after the initial instruction is fetched from the address in the privilege violation exception vector.

8.2.6 Trace Exception

To aid in program development, the M68000 family includes an instruction-by-instruction tracing capability. In the trace mode, an instruction generates a trace exception after the instruction completes execution, allowing a debugging program to monitor execution of a program.

In general terms, a trace exception is an extension to the function of any traced instruction. The execution of a traced instruction is not complete until trace exception processing is complete. If an instruction does not complete due to an access error or address error exception, trace exception processing is deferred until after execution of the suspended instruction is resumed. If an interrupt is pending at the completion of an instruction, trace exception processing occurs before interrupt exception processing starts. If an instruction forces an exception as part of its normal execution, the forced exception processing occurs before the trace exception is processed.

The T-bit in the supervisor portion of the SR controls tracing. The state of the T-bit when an instruction begins execution determines whether the instruction generates a trace exception after the instruction completes.

Note that if the processor is executing in trace mode when a group 2 or 3 exception is signaled, a trace exception will not be generated. This means that for the second example, as the TRAP exception handler completes its execution and performs its RTE, the next instruction of the program sequence will be executed before the next trace exception is performed (the MC68060 will not trace immediately after the TRAP). If tracing is required immediately following a group 2 or 3 exception, the SR contained in the exception stack frame should be checked before returning to the next instruction. If the stacked SR indicates that the processor was executing in trace mode, the trace handler should be executed to account for the instruction that initiated the exception. Refer to **8.2 Integer Unit Exceptions** for a list of group 2 or 3 exceptions.

Trace exception processing starts at the end of normal processing for the traced instruction and before the start of the next instruction. As illustrated in Figure 8-1, the processor makes an internal copy of the SR and enters the supervisor mode. It also clears the T-bit of the SR, disabling further tracing. The processor supplies vector number 9 for the trace exception and saves the trace exception vector offset, PC value, and the internal copy of the SR on the supervisor stack. A stack frame of type 2 is generated when this exception is taken. The stacked value of the PC is the logical address of the next instruction to be executed. In addition, the address field of the stack contains the logical address of the instruction that caused the trace exception. Instruction execution resumes after the initial instruction is fetched from the address in the privilege violation exception vector.

When the STOP or LPSTOP instruction is traced, the processor never enters the stopped condition. A STOP or LPSTOP instruction that begins execution with the T-bit set forces a trace exception after it loads the SR. Upon return from the trace exception handler, execution continues with the instruction following the STOP or LPSTOP instruction, and the processor never enters the stopped condition.

8.2.7 Format Error Exception

Just as the processor verifies that the bit pattern contained in the operation word represents a valid instruction, it also performs certain checks of data values for control operations. The RTE and FRESTORE instruction check the validity of the stack format code. The RTE instruction checks if the format field indicates a type supported by the processor (formats 0, 2, 3 or 4). Likewise, for FPU state frames, the FRESTORE instruction checks if the upper 8 bits of the status field contained in the floating-point state frame is valid (\$00, \$60, or \$E0).

If any of these checks determine that the format of the data is improper, the instruction generates a format error exception. This exception saves a stack frame of type 0, generates exception vector number 14, and continues execution at the address in the format exception vector. The stacked PC value is the logical address of the instruction that detected the format error.

8.2.8 Breakpoint Instruction Exception

To provide increased debug capabilities in conjunction with a hardware emulator, the MC68060 provides a series of breakpoint instructions (\$4848–\$484F) which generate a special external bus cycle when executed.

Exception Processing

When the MC68060 executes one of the breakpoint instructions, it performs a breakpoint acknowledge cycle (read cycle) with an acknowledge transfer type (TT=\$3) and transfer modifier value of \$0. Refer to **Section 7 Bus Operation** for a description of the breakpoint acknowledge cycle. After external hardware terminates the bus cycle with either \overline{TA} or \overline{TEA} , the processor performs illegal instruction exception processing. Refer to **8.2.4 Illegal Instruction and Unimplemented Instruction Exceptions** for details on illegal instruction exception processing.

8.2.9 Interrupt Exception

When a peripheral device requires the services of the MC68060 or is ready to send information that the processor requires, it can signal the processor to take an interrupt exception using the \overline{IPLx} signals. The three signals encode a value of 0–7 ($\overline{IPL0}$ is the least significant bit). High levels on all three signals correspond to no interrupt requested (level 0). Values 1–7 specify one of seven levels of interrupts, with level 7 having the highest priority. Table 8-2 lists the interrupt levels, the states of \overline{IPLx} that define each level, and the SR interrupt mask value that allows an interrupt at each level.

Table 8-2. Interrupt Levels and Mask Values

Requested Interrupt Level	Control Line Status			Interrupt Mask Level Required for Recognition
	$\overline{IPL2}$	$\overline{IPL1}$	$\overline{IPL0}$	
0	Negated	Negated	Negated	No Interrupt Requested
1	Negated	Negated	Asserted	0
2	Negated	Asserted	Negated	0–1
3	Negated	Asserted	Asserted	0–2
4	Asserted	Negated	Negated	0–3
5	Asserted	Negated	Asserted	0–4
6	Asserted	Asserted	Negated	0–5
7	Asserted	Asserted	Asserted	0–7

When an interrupt request has a priority higher than the value in the interrupt priority mask of the SR (bits 10–8), the processor makes the request a pending interrupt. Priority level 7, the nonmaskable interrupt, is a special case. Level 7 interrupts cannot be masked by the interrupt priority mask, and they are transition sensitive. The processor recognizes an interrupt request each time the external interrupt request level changes from some lower level to level 7, regardless of the value in the mask. Figure 8-3 shows two examples of interrupt recognitions, one for level 6 and one for level 7. When the MC68060 processes a level 6 interrupt, the SR mask is automatically updated with a value of 6 before entering the handler routine so that subsequent level 6 interrupts and lower level interrupts are masked. Provided no instruction that lowers the mask value is executed, the external request can be lowered to level 3 and then raised back to level 6 and a second level 6 interrupt is not processed. However, if the MC68060 is handling a level 7 interrupt (SR mask set to level 7) and the external request is lowered to level 3 and then raised back to level 7, a second level 7 interrupt is processed. The second level 7 interrupt is processed because the level 7 interrupt is transition sensitive. A level comparison also generates a level 7 interrupt if the request level and mask level are at 7 and the priority mask is then set to a lower level (as

with the MOVE to SR or RTE instruction). The level 6 interrupt request and mask level example in Figure 8-3 is the same as for all interrupt levels except 7.

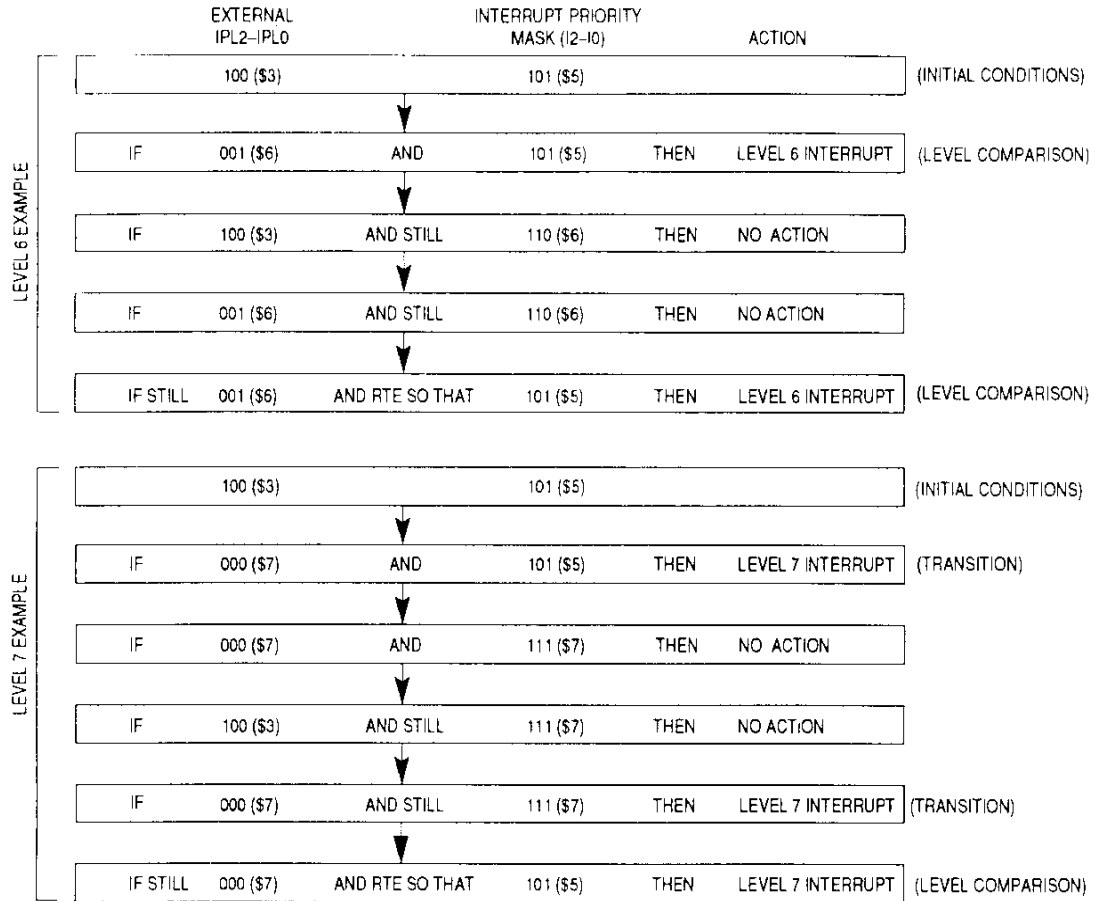

Figure 8-3. Interrupt Recognition Examples

Note that a mask value of 6 and a mask value of 7 both inhibit request levels of 1–6 from being recognized. In addition, neither masks an interrupt request level of 7. The only difference between mask values of 6 and 7 occurs when the interrupt request level is 7 and the mask value is 7. If the mask value is lowered to 6, a second level 7 interrupt is recognized.

External circuitry can chain or otherwise merge signals from devices at each level, allowing an unlimited number of devices to interrupt the processor. When several devices are connected to the same interrupt level, each device should hold its interrupt priority level constant until its corresponding interrupt acknowledge bus cycle ensures that all requests are processed. Refer to **Section 7 Bus Operation** for details on the interrupt acknowledge cycle.

Figure 8-4 illustrates a flowchart for interrupt exception processing. When processing an interrupt exception, the processor first makes an internal copy of the SR, sets the mode to supervisor, suppresses tracing, and sets the processor interrupt mask level to the level of the interrupt being serviced. The processor attempts to obtain a vector number from the

Exception Processing

interrupting device using an interrupt acknowledge bus cycle with the interrupt level number output on the transfer modifier signals. For a device that cannot supply an interrupt vector, the autovector signal (\overline{AVEC}) must be asserted. In this case, the MC68060 uses an internally generated autovector, which is one of vector numbers 25–31, that corresponds to the interrupt level number (see Table 8-1). If external logic indicates a bus error during the interrupt acknowledge cycle, the interrupt is considered spurious, and the processor generates the spurious interrupt vector number, 24.

Once the vector number is obtained, the processor creates a stack frame of type 0. In this stack frame, the processor saves the exception vector offset, PC value, and the internal copy of the SR on the supervisor stack. The saved value of the PC is the logical address of the next instruction had the interrupt not occurred.

Unlike previous processors of the M68000 family, the MC68060 defers interrupt sampling from the beginning of exception processing of any exception, up to and until the first instruction of the exception handler. This allows the first instruction of any exception handler to raise the interrupt mask level and therefore execute the exception handler without interrupts (except level 7 interrupts).

Most M68000 family peripherals use programmable interrupt vector numbers as part of the interrupt acknowledge operation for the system. If this vector number is not initialized after reset and the peripheral must acknowledge an interrupt request, the peripheral usually returns the vector number for the uninitialized interrupt vector, 15.

8

8.2.10 Reset Exception

Asserting the reset in (\overline{RSTI}) input signal causes a reset exception. The reset exception has the highest priority of any exception; it provides for system initialization and recovery from catastrophic failure. Reset also aborts any processing in progress when \overline{RSTI} is recognized; processing cannot be recovered. Figure 8-5 is a flowchart of the reset exception processing.

The reset exception places the processor the supervisor mode by setting the S-bit and disables tracing by clearing the T-bit in the SR. This exception also sets the processor's interrupt priority mask in the SR to the highest level, level 7. Next the VBR is initialized to zero (\$00000000), and all bits in the cache control register (CACR) for the on-chip caches are cleared. The reset exception also clears the translation control register (TCR). It clears the enable bit in each of the four transparent translation registers (TTRs). It also clears the bus control register (BUSCR), and the PCR. The reset also affects the FPU. A quiet not-a-number (NaN) is loaded into each of the seven floating-point registers, and the floating-point control register (FPCR), floating-point status register (FPSR), and floating-point instruction address register (FPIAR) are cleared. If the processor is granted the bus, and the processor does not detect \overline{TS} asserted (possibly by an alternate master), the processor then performs two long-word read bus cycles. The first long word, at address 0, is loaded into the SP, and the second long word, at address 4, is loaded into the PC. Reset exception processing concludes with the transfer of control to the memory location defined by the PC.

After the initial instruction is fetched, program execution begins at the address in the PC. The reset exception does not flush the ATCs or invalidate entries in the instruction or data caches; it does not save the value of either the PC or the SR. If an access error or address

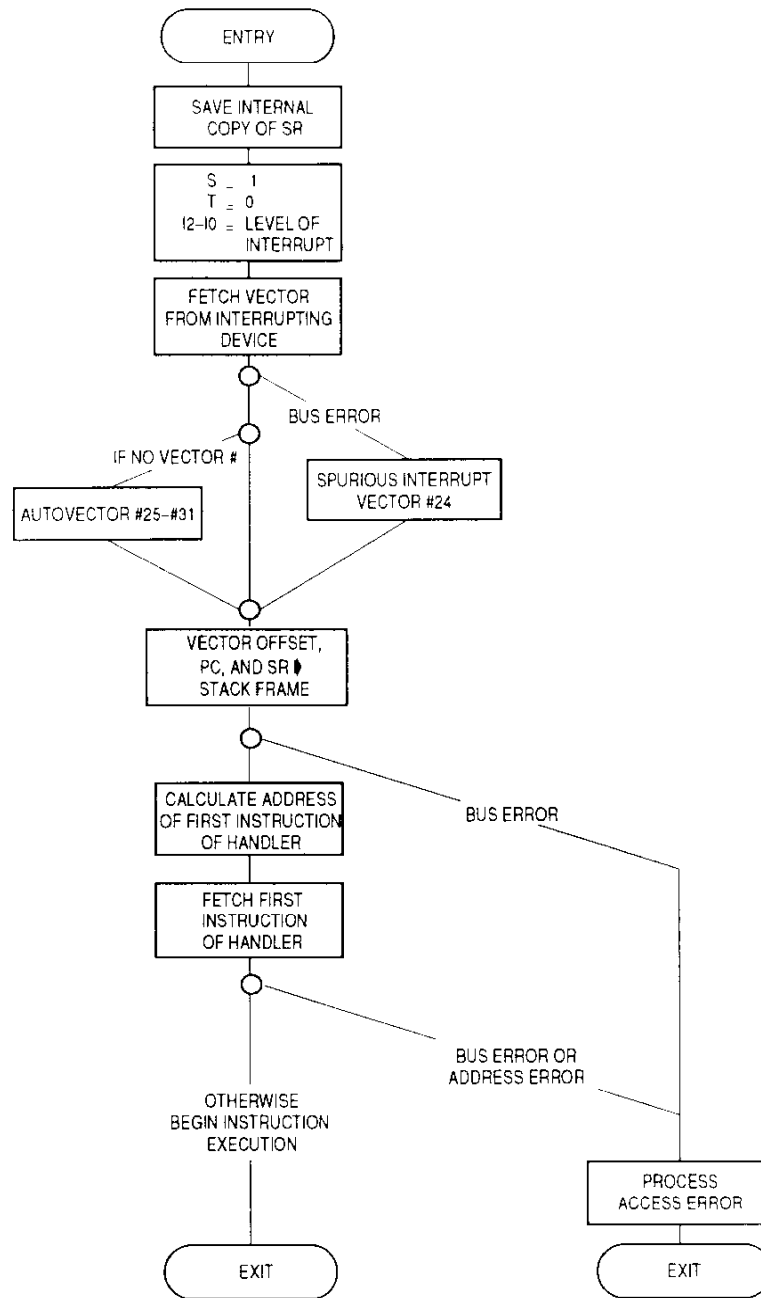

Figure 8-4. Interrupt Exception Processing Flowchart

error occurs during the exception processing sequence for a reset, a double bus fault is generated. The processor halts and signals the double bus fault status on the processor status outputs ([PST4–PST0] = \$1C). Execution of the reset instruction does not cause a reset exception, nor does it affect any internal registers except the PC. The execution of this instruction causes the MC68060 to assert the \overline{RSTO} signal, allowing other devices within the system to be reset.

Exception Processing

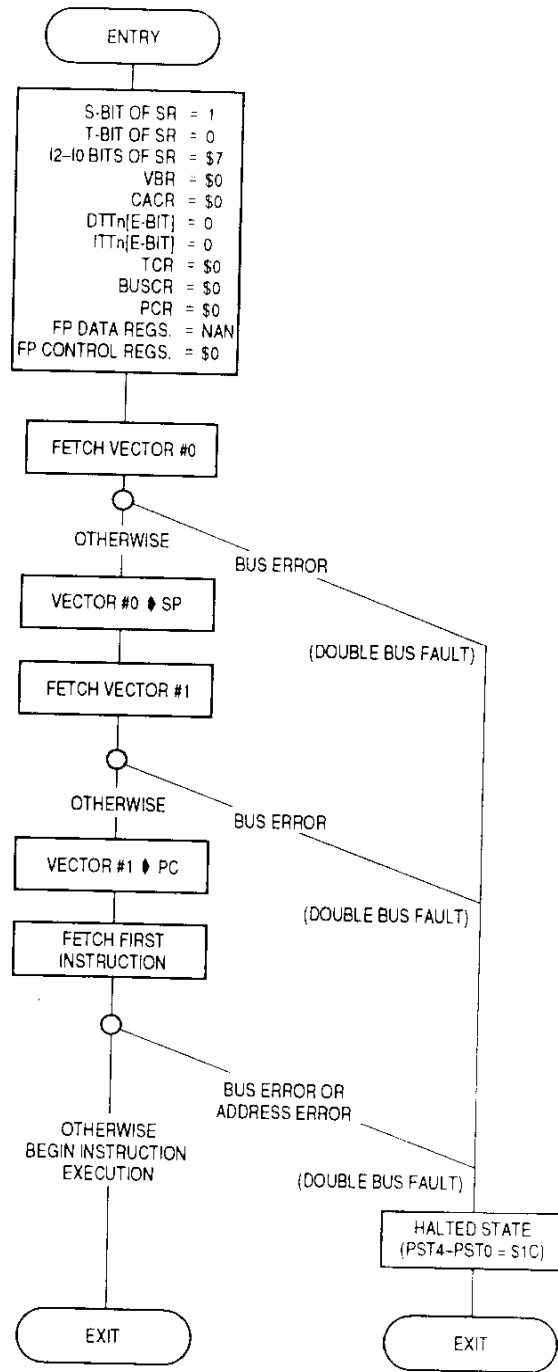

Figure 8-5. Reset Exception Processing Flowchart

8.3 EXCEPTION PRIORITIES

Exceptions can be divided into the five basic groups identified in Table 8-3. These groups are defined by specific characteristics and the order in which they are handled. Table 8-3 represents the priority used for simultaneous faults, as viewed by the MC68060 hardware. In Table 8-3, 0.0 represents the highest priority, while 4.1 is the lowest. Note that there are shared priorities for exceptions within Group 3, since these types are mutually exclusive.

Table 8-3. Exception Priority Groups

Group.Priority	Exception and Relative Priority	Characteristics
0.0	Reset	The processor aborts all processing (instruction or exception) and does not save old context.
1.0 1.1 1.2	Address Error Instruction Access Error Data Access Error	The processor suspends processing and saves the processor context.
2.0 2.1 2.2 2.3 2.4 2.5	A-Line Unimplemented F-Line Unimplemented Illegal Instruction Privilege Violation Unimplemented EA Unimplemented Integer	Exception processing begins before the instruction is executed.
2.6	Floating-Point Unimplemented Instruction, Floating-Point Unsupported Data Type	Exception processing begins after the initial memory operand address is calculated, but before instruction is executed.
3.0 3.1 3.2 3.3 3.4 3.5 3.6	Floating-Point BSUN*, CHK, CHK2, Divide-by-Zero, TRAPV, TRAPcc, TRAP #n, RTE Format Error Floating-Point SNAN* Floating-Point OPERR* Floating-Point OVFL* Floating-Point UNFL* Floating-Point DZ* Floating-Point INEX*	Exception processing is part of instruction execution and begins after instruction execution.
4.0 4.1	Trace Interrupt	Exception processing begins when the current instruction is completed.

Refer to **Section 6 Floating-Point Unit (MC68060 Only)** for details concerning floating-point instructions. For the case of an emulated FTRAPcc instruction and a floating-point BSUN exception, the BSUN is considered higher priority.

Within an MC68060 system, more than one exception can occur at the same time. The reset exception is unique; central processing unit (CPU) reset overrides and clears all other exceptions which may have occurred at the same time. All other exceptions are handled according to the priority relationship defined in Table 8-3.

The method used to process exceptions in the MC68060 is similar to that found on the MC68040 due to the restart exception model. In general, when multiple exceptions are pending, the exception with the highest priority is processed first, and the remaining exceptions are regenerated when the original faulting instruction is restarted.

To clarify the exception priority within group 1, it is important to note that instruction fetch pipeline (IFP) access errors are not recognized until the faulted portion of the instruction is actually used (or attempted to be used). As an example, consider a "move.l (An), xxx.l" instruction. If the source operand defined at the address contained in An is faulted, the operand access error will occur. If the extension words defining the destination address are also faulted, the IFP access error would be processed after the source operand fault. Thus, in

Exception Processing

this example, the instruction has two faults (instruction access error and operand access error), but the faults are not simultaneous and appear as an operand access error on the source address and an instruction access error on the destination address to the processor. Another item to note is that for instructions with indirect addresses, the processing of the indirection is always completed prior to the instruction entering normal OEP sequence control.

To illustrate the handling of multiple exceptions, consider first a pending interrupt being posted while a program is executing in trace mode (i.e., bit 15 of the SR is set).

Since the processor always samples for pending interrupts and traces at the conclusion of instruction execution, both the trace and the interrupt appear simultaneous to the processor. Since the trace has higher priority than the interrupt (4.0 versus 4.1), trace exception processing begins. After the first instruction of the trace exception handler has been executed, the processor again samples for pending interrupts. Providing the previous interrupt is still pending, the processor now begins interrupt exception processing. As the interrupt handler completes execution, control returns to the trace handler. As the trace handler completes, control returns to the original program.

8

As a second example of the handling of multiple exceptions, consider the prior scenario (a pending interrupt being posted while a program is executing in trace mode) at the same time a TRAP instruction enters the OEP.

As described before, since the processor always samples for pending interrupts and traces at the conclusion of instruction execution, both the trace and the interrupt appear simultaneous to the processor. Since the trace has higher priority than the interrupt, trace exception processing begins. After the first instruction of the trace exception handler has been executed, the processor again samples for pending interrupts. Providing the previous interrupt is still pending, the processor begins interrupt exception processing. As the interrupt handler completes execution, control returns to the trace handler. As the trace handler completes, control returns to the original program, where the TRAP instruction is executed, causing that exception to occur.

Note that if the processor is executing in trace mode when a group 2 or 3 exception is signaled, a trace exception will not be generated. This means that for the second example, as the TRAP exception handler completes its execution and performs its RTE, the next instruction of the program sequence will be executed before the next trace exception is performed (the MC68060 will not trace immediately after the TRAP). If tracing is required immediately following a group 2 or 3 exception, the SR contained in the exception stack frame should be checked before returning to the next instruction. If the stacked SR indicates that the processor was executing in trace mode, the trace handler should be executed to account for the instruction that initiated the exception.

Considering the previous example, the TRAP handler should check the stacked SR, and since the processor was executing in trace mode, pass control to the trace handler. If this check is not made, the next trace exception will not occur until the instruction after the TRAP has completed execution.

8.4 RETURN FROM EXCEPTIONS

Once the processor has completed processing of all exceptions, it must restore the machine context at the time of the initial exception before returning control to the original process.

Since the MC68060 is a complete restart machine, when the processor executes an RTE instruction, only three fields are referenced. The stack format is accessed (SP+6) and the frame type is first verified. If the format indicates an invalid type, a format error exception is signaled. Otherwise, the processor accesses the SR (SP) and PC (SP+2) fields from the top of the supervisor stack. If the PC value defines an odd address (least significant address bit is set), then an address error exception is signaled. Note that for the format error or the address error, the new stack frame will contain the SR value at the time the RTE's execution began, i.e., the SR has not been corrupted by the execution of the RTE. For either fault, the PC is the logical address of the RTE instruction.

Given a valid stack format and a nonfaulting PC, the SR and PC are loaded with the stack operands, the SSP adjusted by the appropriate value determined by the format field, and control passed to the location defined by the new PC.

When the processor writes or reads a stack frame, it uses long-word operand transfers wherever possible. Using a long-word-aligned SP enhances exception processing performance. The processor does not necessarily read or write the stack frame data in sequential order. The following paragraphs discuss in detail each stack frame format.

Note that unlike any of the previous M68000 processors, the MC68060 RTE instruction treats the access error frame no differently from other frames.

8.4.1 Four-Word Stack Frame (Format \$0)

If a four-word stack frame is on the stack and an RTE instruction is encountered, the processor updates the SR and PC with the data read from the stack, increments the stack pointer by eight, and resumes normal instruction execution

Stack Frames	Exception Types	Stacked PC Points To
<p>FOUR-WORD STACK FRAME-FORMAT \$0</p>	<ul style="list-style-type: none"> • Interrupt • Format Error • TRAP #N • Illegal Instruction • A-Line Instruction • F-Line Instruction • Privilege Violation • Floating-Point Pre-Instruction • Unimplemented Integer • Unimplemented Effective Address 	<ul style="list-style-type: none"> • Next Instruction • RTE or FRESTORE Instruction • Next Instruction • Illegal Instruction • A-Line Instruction • F-Line Instruction • First Word of Instruction Causing Privilege Violation • Floating-Point Instruction • Unimplemented Integer Instruction • Instruction That Used the Unimplemented Effective Address

Exception Processing

8.4.2 Six-Word Stack Frame (Format \$2)

If a six-word stack frame is on the stack and an RTE instruction is encountered, the processor restores the SR and PC values from the stack, increments the SSP by \$C, and resumes normal instruction execution.

Stack Frames	Exception Types	Stacked PC Points To; Address Field Has
<p>SIX-WORD STACK FRAME-FORMAT \$2</p>	<ul style="list-style-type: none"> • CHK, CHK2 (Emulated), TRAPcc, FTRAPcc(Emulated), TRAPV, Trace, or Zero Divide • Unimplemented Floating-Point Instruction • Address Error 	<ul style="list-style-type: none"> • Next Instruction; Address field has the address of the instruction that caused the exception. • Next Instruction; Address field has the calculated <ea> for the floating-point instruction. • Instruction that caused the address error; Address field has the branch target address with A0=0.

8.4.3 Floating-Point Post-Instruction Stack Frame (Format \$3)

In this case, the processor restores the SR and PC values from the stack and increments the supervisor stack pointer by \$C. If another floating-point post-instruction exception is pending, exception processing begins immediately for the new exception; otherwise, the processor resumes normal instruction execution.

Stack Frames	Exception Types	Stacked PC Points To; Effective Address Field
<p>FLOATING-POINT POST-INSTRUCTION STACK FRAME-FORMAT \$3</p>	<ul style="list-style-type: none"> • Floating-Point Post-Instruction 	<ul style="list-style-type: none"> • Next Instruction; Effective Address field is the calculated effective address for the floating-point instruction.

8.4.4 Eight-Word Stack Frame (Format \$4)

An eight-word stack frame is created for data and instruction access errors. It is also used for the floating-point disabled exception. Refer to 8.2.4 Illegal Instruction and Unimplemented Instruction Exceptions for details on the use of this frame for the floating-point disabled exception. The following paragraphs describe in detail the format for this frame as used by for the access error and how the processor uses it when returning from exception processing.

Stack Frames	Exception Types	Stacked PC Points To
	<ul style="list-style-type: none"> Data or Instruction Access Fault (ATC Fault or Bus Error) Floating-Point Disabled Exception 	<ul style="list-style-type: none"> See 8.4.4.1 Program Counter (PC), 8.4.4.2 Fault Address, and 8.4.4.3 Fault Status Long Word (FSLW) for additional information. Next instruction; Effective Address Field has calculated <ea> of memory operand (if any); PC of Faulted Instruction points to the F-line instruction word of the floating-point instruction.

8.4.4.1 Program Counter (PC). On read access faults, the PC points to the instruction that caused the access error. This instruction is restarted when an RTE is executed, hence, the read cycle is re-executed. On read access errors on the second or later of misaligned reads, the read cycles that are successful prior to the access error are re-executed since the processor uses a restart model for recovery from exceptions.

Programs that rely on a read bus error to test for the existence of I/O or peripheral devices must increment the value of the PC prior to the execution of the RTE instruction. Incrementing the PC involves the calculation of the instruction length, which is dependent on the addressing mode used. To avoid having to calculate the instruction length, it is possible to use a NOP-TEST_WRITE-NOP instead of a TEST_READ of the I/O or peripheral device. The initial NOP causes all prior write cycles to complete. The TEST_WRITE causes the access error, and if the write cycle is to imprecise operand space, the stacked PC of the access error stack contains the address of the second NOP. When the RTE is executed, instruction execution resumes at the second NOP. The limitation of this method is that it works only if the I/O device is mapped to imprecise operand space. If the write is to a precise operand space, the processor does not increment the PC, and the stacked PC contains the instruction address of the TEST_WRITE.

On write access errors, the PC points to the instruction that causes the access error except for bus error (TEA) on writes that involve the push and store buffers. Refer to 8.4.4.3 Fault Status Long Word (FSLW) for specific information on these write cases. For these write cases, the PC does not point to the instruction that caused the access error. Hence the write cycle that incurred the bus error is lost. In general, bus errors on writes must be avoided. The processor provides little support for recovery on bus errored write cycles to imprecise operand spaces. For precise spaces, both the faulting PC and logical operand address are directly provided in the exception frame.

Exception Processing

I/O devices or peripherals that use multiple pages (paged MMU) to define the cache mode and that cannot tolerate duplicate reads must not allow code that causes misaligned reads that cross page boundaries. In this case, either use the TTRs or the default TTR to define the I/O or peripheral cache mode. I/O devices or peripherals must not be accessed using instructions which perform both read and write cycles (e.g., a memory-to-memory move) unless the devices accessed are capable of handling rerun cycles caused by a processor with a restart recovery model.

8.4.4.2 Fault Address. The fault address field contains the logical address of the access that incurred the access error. The SIZE, TT, TM, R- and W-bits of the FSLW qualify the fault address. For MMU-related exceptions (e.g., missing page faults, write protect, supervisor protect), the fault address is the logical address calculated by the integer unit. For misaligned operand access faults, the fault address points to the initial logical address calculated by the integer unit regardless of which bus cycle actually faulted. For instruction extension word faults, this field points to the logical address of the instruction opword and not the extension word.

8.4.4.3 Fault Status Long Word (FSLW). The FSLW information indicates whether an access to the instruction stream or the data stream (or both) caused the fault and contains status information for the faulted access. Figure 8-6 illustrates the FSLW format.

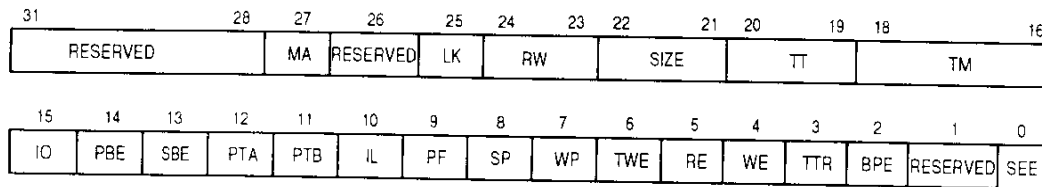

Figure 8-6. Fault Status Long-Word Format

Bits 31–28, 26, and 1—Reserved by Motorola.

IO, MA—Instruction or Operand, Misaligned Access

IO, MA

- 0, 0 = Fault occurred on the first access of a misaligned transfer, or to the only access of an aligned transfer.
- 0, 1 = Fault occurred on the second or later access of a misaligned transfer.
- 1, 0 = Fault occurred on an instruction opword fetch.
- 1, 1 = Fault occurred on a fetch of an extension word.

LK—Locked Transfer

0 = Fault did not occur on a locked transfer.

1 = Fault occurred on a locked transfer initiated by the processor (e.g., TAS, CAS, table searches). Also set on locked transfers within the boundaries defined by the MOVEC of BUSCR (LOCK bit) instruction.

RW—Read and Write

- 00 = Undefined, reserved
- 01 = Write
- 10 = Read
- 11 = Read-Modify-Write

A read-modify-write indicates that the referenced address is capable of being read and written. For example, for an ADD D0,<ea> instruction, the memory operand is read, modified, and then written by this instruction. A read-modify-write does not imply a “locked” sequence.

SIZE—Transfer Size

- 00 = Byte
- 01 = Word
- 10 = Long
- 11 = Double Precision or MOVE16

The SIZE field corresponds to the original access size. If a data cache line read results from a read miss and the line read encounters a bus error, the SIZE field in the resulting stack frame indicates the size of the original read generated by the execution unit.

TT—Transfer Type

This field defines the TT1–TT0 signal encoding for the faulted access.

TM—Transfer Modifier

This field defines the TM2–TM0 signal encoding for the faulted access.

PBE—Push Buffer Bus Error

- 0 = Fault not caused by a bus error (\overline{TEA} asserted) during a push buffer write.
- 1 = Fault caused by a bus error (\overline{TEA} asserted) during a push buffer write.

SBE—Store Buffer Bus Error

- 0 = Fault not caused by a bus error (\overline{TEA} asserted) during a store buffer write.
- 1 = Fault caused by a bus error (\overline{TEA} asserted) during a store buffer write.

PTA—Pointer A Fault

- 0 = Fault not due to an invalid root level descriptor.
- 1 = Fault due to an invalid root level descriptor.

PTB—Pointer B Fault

- 0 = Fault not due to an invalid pointer level descriptor.
- 1 = Fault due to an invalid pointer level descriptor.

IL—Indirect Level Fault

- 0 = Fault not due to encountering a second indirect page descriptor.
- 1 = Fault due to encountering a second indirect page descriptor.

Exception Processing

PF—Page Fault

- 0 =Fault not due to an invalid page descriptor.
- 1 =Fault due to an invalid page descriptor.

SP—Supervisor Protect

- 0 =Fault not due to user process accessing a page that is supervisor protected.
- 1 =Fault due to user process accessing a page that is supervisor protected.

WP—Write Protect

- 0 =Fault not due to a write access on a write-protected page.
- 1 =Fault due to a write access on a write-protected page.

TWE—Bus Error (\overline{TEA} asserted) on Table Search

- 0 =Fault is not caused by a bus error during any MMU table search read or write.
- 1 =Fault is caused by a bus error during any MMU table search read or write.

RE—Bus Error (\overline{TEA} asserted) on Read

- 0 =Fault is not caused by a bus error on a read cycle.
- 1 =Fault is caused by a bus error on a read cycle.

WE—Bus Error (\overline{TEA} asserted) on Write

- 0 =Fault is not caused by a bus error on a write cycle.
- 1 =Fault is caused by a bus error on a write cycle.

TTR—TTR Hit

- 0 =Fault is detected on an access that is mapped by the a paged MMU translation or a default TTR translation.
- 1 =Fault is detected on an access that is mapped by one of the four TTRs.

BPE—Branch Prediction Error

- 0 =Fault is not caused by a branch prediction error.
- 1 =Fault is caused by a branch prediction error.

Refer to **8.4.7 Branch Prediction Error** for details on this error type.

SEE—Software Emulation Error

- 0 =Fault is not caused by a software emulation error.
- 1 =Fault is caused by a software emulation error.

The processor does not set the SEE bit. This bit is used by the M68060SP to indicate a software emulation error case. Refer to **Appendix C MC68060 Software Package** for details on how this bit is set.

8.4.5 Recovering from an Access Error

The access error exception handler can identify the cause of the fault by examining the FSLW. Unlike earlier processors, the MC68060 provides all the information needed to identify the fault by examining the FSLW. Note that this section does not discuss the use of the SEE (software emulation error) bit nor does it provide the procedure needed to support the M68060SP misaligned CAS and CAS2 emulation code. Refer to **Appendix C MC68060 Software Package** for details of how access error recovery is affected by the M68060SP.

The first step to recovering from an access error is for the exception handler to determine whether or not a branch prediction error has occurred. See **8.4.7 Branch Prediction Error** for details on how a branch prediction error occurs. If the BPE bit in the FSLW is set, flush the branch cache and continue with normal access error handling. If no other faults are indicated, then execute an RTE and continue normal operations.

The second step for the handler is to determine whether or not the access error is recoverable. In general, bus errors (TEA Asserted) on write cycles must be avoided. Refer to **8.4.6 Bus Errors and Pending Memory Writes** for further details of bus errors and pending memory writes. In summary, check for any of the following nonrecoverable write cases:

- PBE = 1 (push buffer bus error)
- SBE = 1 (store buffer bus error)
- RW = 11, IO = 0, MA=1 (bus error on misaligned read-modify-write)
- RW = 01, for a MOVE <ea>, <ea> in which the destination operand writes over the source operand.

For these nonrecoverable write cases, the write reference has been lost and it is up to the system software designer to determine the next course of action. Probably the most prudent course of action is to discontinue the user program and enter a known supervisor state.

The third step is to handle the transparent translation access error cases. This is indicated by TTR=1. All of these cases are recoverable as long as step two from above has been taken out. At this point, the access error may be caused by the following errors, which are mutually exclusive.

- SP = 1 (supervisor protection violation detected by one of the four TTRs)
- WP = 1 (write protection violation detected by one of the four TTRs)
- RE = 1 (bus error on read)
- WE = 1 (bus error on write)

For the SP = 1 or WP = 1 cases, it is possible to modify the transparent translation descriptor to allow the access to occur once the instruction is restarted.

For the RE = 1 or WE = 1 cases, unless the cause of the bus error is removed, when the instruction is restarted, the access error handler is re-entered, possibly resulting in an infinite loop.

Exception Processing

The fourth step is to handle the paged memory management invalid descriptor cases. This step is unnecessary if using an MC68EC060 or if the paged MMU is disabled. An invalid descriptor is indicated by $TTR = 0$, and any one of the following bits are set: PTA, PTB, IL, PF, and TWE. These bits indicate the cause of the access error and are mutually exclusive:

- $TWE = 1$ (bus error detected during MMU table search reads or writes)
- $PTA = 1$ (invalid root level descriptor)
- $PTB = 1$ (invalid pointer-level descriptor)
- $IL = 1$ (a second indirect level descriptor is encountered)
- $PF = 1$ (invalid page descriptor)

Of the above cases, the TWE bit case must be handled with special care. Since no information is given as to when the bus error is encountered, it is possible to encounter the bus error again in the process of locating the fault.

The paged memory management architecture allows for only one level of indirection. A page descriptor of type indirect must point to a page descriptor of type resident. If that second page descriptor is of type invalid, an exception is taken such that $PF = 1$. If that second page descriptor is of type indirect, a second level of indirection is attempted, and an exception is taken such that $IL = 1$. If $IL = 1$, the handler must supply a page descriptor of type resident.

The PTA, PTB, PF cases require that the exception handler allocate physical memory for the appropriate page and update the appropriate descriptor. When the instruction is restarted, the table search either encounters the next table search fault or executes successfully.

It is important to note that the MC68060 performs table searches in hardware and does not use the fetch table and page descriptors from the cache. The descriptor tables must be placed in noncacheable memory so that when the exception handler touches these descriptors, that the physical image in memory is updated properly.

Also note that since table searches that result in invalid descriptors (TWE, PTA, PTB, IL, PF) do not update the ATC, the ATC need not be flushed by the exception handler.

The fifth step is to handle the paged memory management protection violation and bus error cases. This step is unnecessary if using an MC68EC060 or if the paged MMU is disabled. At this point, the table search has resulted in a valid page descriptor, and that the ATC has been updated. As long as fourth step above is handled, following causes are possible and are mutually exclusive:

- $SP = 1$ (supervisor protection violation detected by paged MMU)
- $WP = 1$ (write protection violation detected by paged MMU)
- $RE = 1$ (bus error on read)
- $WE = 1$ (bus error on write)

For the protection violation cases (SP and WP), if the access is to be allowed, the page descriptor must be updated, and the corresponding ATC entry must be flushed. When the

instruction is restarted, another table search is performed, and the instruction is executed successfully. If the access is not allowed, it is up to the system software designer to determine appropriate action.

For the physical bus error cases, as long as it is not one of the non-recoverable write cases, the exception handler must fix the page descriptor to point to a different physical memory, so that when the restart of the instruction occurs, that bus error does not recur.

It is important to note that the MC68060 performs table searches in hardware, and does not use the fetch table and page descriptors from the cache. The descriptor tables must be placed in non-cachable memory so that when the exception handler touches these descriptors, that the physical image in memory is updated properly.

The sixth step is to handle the default TTR cases. The default TTR is indicated if none of these bits are set: TTR, PTA, PTB, IL and PF. At this point, only the following cases are possible:

- WP = 1 (write protection violation detected by default TTR)
- RE = 1 (bus error on read)
- WE = 1 (bus error on write)

These cases may be handled similarly to step three. If the exception handler has gotten to this point, but none of the WP, RE and WE bits are set, and if the BPE bit is set and has been handled by the first step, then execute an RTE.

8.4.6 Bus Errors and Pending Memory Writes

The MC68060 processor contains two different write buffers for pending memory write operations: the store buffer and the push buffer. The store buffer is used to optimize performance by deferring bus write operations in write through and imprecise cache modes, and the push buffer holds displaced copyback mode cache lines and line write data for the MOVE16 instruction.

The push buffer holds a displaced cache line destined for memory until the cache-miss bus read access that caused the push completes. Imprecise cache modes (cachable write-through and copyback, and cache inhibited, imprecise) use the write buffers of the MC68060 to optimize system performance. Cache inhibited precise mode provides a precise exception model for MC68060 operation, not utilizing the write buffers (store or push).

When the MC68060 detects an exception condition, all instruction execution is aborted and the exception processing state is entered. Upon entering this state, the pipeline stalls until both the store and push buffers are empty before beginning exception processing. If a \overline{TEA} signal termination occurs during a memory write cycle while emptying the store buffer, 'a bus error \overline{TEA} on store buffer' is recorded and the buffer sequences through all the remaining, pending writes. However, if a \overline{TEA} signal termination occurs during a memory write cycle while emptying the push buffer, 'a bus error \overline{TEA} on push buffer' is recorded and the memory write operation is aborted immediately.

Exception Processing

Once the write buffers (push and store) are all empty, the pipeline re-evaluates the pending exception types. If no \overline{TEA} fault occurred during the emptying of the buffers, the processor continues with the original exception. If a \overline{TEA} fault did occur as the buffers were emptied, the original exception is discarded and an operand data access error exception is taken. The exception stack for the access error includes indicator bits in the FSLW signalling the occurrence of the push buffer \overline{TEA} or store buffer \overline{TEA} . Note that both errors may be present within a single access error exception. The exception stack frame will record the PC value at the time the exception was detected, but this value has no relationship to the instruction that caused the push or store buffer entries to originally be made. The stacked virtual address is meaningless for these two fault types.

There are other non-recoverable write cases which are unrelated to the push and store buffer cases. The execution of a misaligned read-modify-write instruction which partially completes the writes before faulting is inherently non-recoverable on a restart machine. Consider the ADD D0, <mem> instruction. In this instruction, the processor fetches the memory operand, adds the contents of D0 internally, and writes the result out to memory. If the memory operand is misaligned and a bus error occurs on the second or later access, the first part of the memory operand would have been overwritten. If the instruction enters the access error exception handler, it cannot be restarted because original memory value has been corrupted. This read-modify-write instruction and others like it can be detected in the access error handler because the access error frame has separate read and write bits (RW field). If both bits are set, the instruction is a read-modify-write instruction similar to the ADD instruction case as discussed.

Another non-recoverable write case is similar to the ADD case above, but is more difficult to detect. A MOVE <mem>, <mem> instruction in which the source operand and destination operand overlap may have the same problems as discussed in the ADD instruction if the destination operand is part of the source operand and a misaligned write occurs, which result in an access error on the second or later misaligned case. The MOVE <mem>, <mem> instruction is not normally considered a read-modify-write type of instruction, and is not detected simply by looking at the RW bits in the FSLW.

An MC68060 system design could implement address/data capture logic to provide additional information for these bus error scenarios.

8.4.7 Branch Prediction Error

A branch prediction error occurs when a taken branch instruction is executed creating a branch cache entry and then this same code is re-executed with the former branch instruction now appearing as an extension word for another opcode. In this type of sequence where the interpretation of the code stream is dynamically changed, a branch prediction error may occur.

In the past, Motorola had suggested using a TRAPF (word or long) instruction to remove a branch in the following construct:

```
                bra    label2
label1:         <op1>
label2:         <op2>
```

where a TRAPF (word or long) can be substituted for the branch instruction and the subsequent instruction, <op1> instruction effectively appears as the extension word of the TRAPF.

The BPE bit of the FSLW can be asserted if the <op1> instruction is a taken branch instruction, but the likelihood of this usage is expected to be very low. The replacement of branch instructions using this TRAPF construct is still recommended for cases where <op1> is not a branch instruction. It is the responsibility of the access error handler to test the BPE bit, and if asserted, clear the branch cache. Refer to **8.4.5 Recovering from an Access Error** for details on how to recover from this error.

SECTION 9

IEEE 1149.1 TEST (JTAG) AND DEBUG PIPE CONTROL MODES

This section describes the IEEE 1149.1 test access port (normal Joint Test Action Group (JTAG)) mode and the debug pipe control mode, which are available on the MC68060.

9.1 IEEE 1149.1 TEST ACCESS PORT (NORMAL JTAG) MODE

The MC68060 includes dedicated user-accessible test logic that is fully compliant with the IEEE standard 1149.1-1993 *Standard Test Access Port and Boundary Scan Architecture* except in the case where the JTAG architecture and the LPSTOP function interact. This case is not formally addressed by the standard, but the MC68060 solution is transparent to the functionality defined by the standard, has the effect of meeting full compatibility to IEEE 1149.1, and has been approved by the IEEE 1149.1 Working Group Committee.

The following description is to be used in conjunction with the supporting IEEE document listed previously. This section includes the description of those chip-specific items that the IEEE standard defines as required as well as those items that are specific to the MC68060 implementation.

The MC68060 JTAG test architecture implementation supports circuit board test strategies that are based on the IEEE standard. This architecture provides access to all of the data and control pins of the chip from the board-edge connector through the standard four pin test access port (TAP) plus the additional optional active low $\overline{\text{TRST}}$ reset pin (see **Section 2 Signal Description** for a description of $\overline{\text{TRST}}$). The test logic itself uses a static design and is entirely independent of the system logic, except where the JTAG mode is subordinate to another complimentary test mode (see **9.2 Debug Pipe Control Mode**). When placed in the subordinate mode, the JTAG test logic is placed in reset and the TAP pins are used for alternate purposes in accordance with the rules and restrictions set forth for the use of a JTAG compliance enable pin.

The MC68060 JTAG implementation provides the capabilities to:

1. Perform boundary scan operations to test circuit board electrical continuity,
2. Bypass the MC68060 by reducing the shift register path to a single cell,
3. Sample the MC68060 system pins during operation and transparently shift out the result,
4. Set the MC68060 output drive pins to fixed logic values while reducing the shift register path to a single cell, and
5. Protect the MC68060 system output and input pins from backdriving and random

IEEE 1149.1 Test (JTAG) and Debug Pipe Control Modes

toggle (such as during in-circuit testing) by placing all system signal pins to a high impedance state.

NOTE

The IEEE standard 1149.1 test logic cannot be considered completely benign to those planning not to use this capability. Certain precautions must be observed to ensure that this logic does not interfere with system operation and allows full use of the LPSTOP function. Refer to **9.1.5 Disabling the IEEE 1149.1 Standard Operation**

9.1.1 Overview

Figure 9-1 illustrates the block diagram of the MC68060 implementation of the 1149.1 standard. The test logic includes several test data registers, an instruction register, instruction register control decode, and a 16-state dedicated TAP controller. The sixteen controller states are defined in detail in the IEEE 1149.1 standard, but eight are listed in Table 9-1 and included for illustration purposes:

Table 9-1. JTAG States

State Name	State Summary
Test-Logic-Reset	Places test logic in default defined reset state
Run-Test-Idle	Allows test control logic to remain idle while test operations occur
Capture-IR	Loads default IDCODE instruction into the instruction register
Shift-IR	Allows serial data to move from TDI to TDO through the instruction register
Update-IR	Applies and activates instruction contained in the instruction shift register
Capture-DR	Loads parallel sampled data into the selected test data register
Shift-DR	Allows serial data to move from TDI to TDO through the selected test data register
Update-DR	Applies test data contained in the selected test data register

The TAP consists of five dedicated signal pins which are controlled by a sixth dedicated compliance enable pin.

1. $\overline{\text{JTAG}}$ —An active low JTAG enable pin that maps the TAP signals to either the 1149.1 logic or the emulation mode logic and meets the requirements set forth for a compliance enable pin. The TAP pins are described in the case of $\overline{\text{JTAG}}$ asserted.
2. TCK—A test clock input that synchronizes test logic operations.
3. TMS—A test mode select input with an internal pullup resistor that is sampled on the rising edge of TCK to sequence the TAP controller.
4. TDI—A serial test data input with an internal pullup resistor that is sampled on the rising edge of TCK.
5. TDO—A three-state test data output that is actively driven only in the shift-IR and shift-DR controller states and only updates on the falling edge of TCK.
6. $\overline{\text{TRST}}$ —An active low asynchronous reset with an internal pullup resistor that forces the TAP controller into the test-logic-reset state.

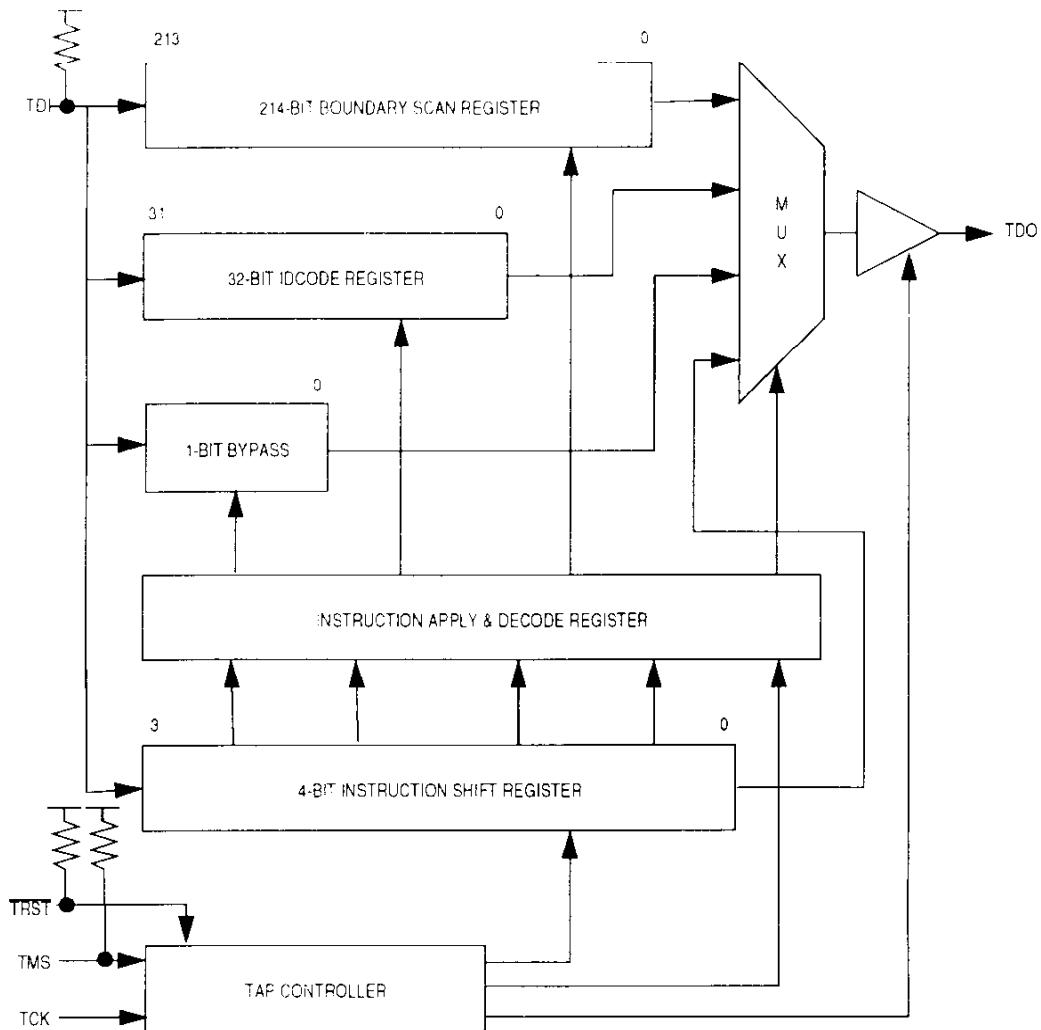

Figure 9-1. JTAG Test Logic Block Diagram

9.1.2 JTAG Instruction Shift Register

The MC68060 IEEE 1149.1 implementation uses a 4-bit instruction shift register without parity. The shift register transfers its value to a parallel hold register and applies one of sixteen possible instructions, seven of which are defined as public customer-usable instructions, on the falling edge of TCK when the TAP state machine is in the update-IR state (the other nine instructions are private instructions to support manufacturing test and can cause destructive behavior if used without proper understanding). The instructions may be loaded into the shift portion of the register by placing the serial data on the TDI signal prior to each rising edge of TCK. The most significant bit of the instruction shift register is the bit closest to the TDI signal and the least significant bit is the bit closest to the TDO pin.

The public customer-usable instructions that are supported are listed with their encodings in Table 9-2.

IEEE 1149.1 Test (JTAG) and Debug Pipe Control Modes

Table 9-2. JTAG Instructions

Instruction	Acro	Class	IR3-IR0	Instruction Summary
EXTEST	EXT	Required	0000	Select boundary scan register to apply fixed values to outputs
LPSAMPLE	LPS	Public	0001	Selects the boundary scan register for data operations while input pins are isolated *
MFG-TEST9	—	Private	0010	For Motorola Internal Manufacturing Test use only
MFG-TEST1	—	Private	0011	For Motorola Internal Manufacturing Test use only
SAMPLE	SMP	Required	0100	Selects boundary scan register for shift, sample and preload
IDCODE	IDC	Optional	0101	Defaults to select the ID code register
CLAMP	CMP	Optional	0110	Selects bypass while fixing output values
HIGHZ	HIZ	Optional	0111	Selects bypass while three-stating all chip outputs
MFG-TEST2	—	Private	1000	For Motorola Internal Manufacturing Test use only
MFG-TEST3	—	Private	1001	For Motorola Internal Manufacturing Test use only
MFG-TEST4	—	Private	1010	For Motorola Internal Manufacturing Test use only
MFG-TEST5	—	Private	1011	For Motorola Internal Manufacturing Test use only
MFG-TEST6	—	Private	1100	For Motorola Internal Manufacturing Test use only
MFG-TEST7	—	Private	1101	For Motorola Internal Manufacturing Test use only
MFG-TEST8	—	Private	1110	For Motorola Internal Manufacturing Test use only
BYPASS	BYP	Required	1111	Selects the bypass register for data operations

*LPSAMPLE is not supported on version 0000. See Figure 9-2 in 9.1.3.1 Idcode Register.

The EXTEST, SAMPLE/PRELOAD, and BYPASS instructions are required by IEEE 1149.1. IDCODE is an optional public instruction supported by the MC68060. CLAMP and HIGHZ are optional public instructions that are supported by the MC68060 and are described the 1149.1-1993 standard. LPSAMPLE is a Motorola-defined public instruction.

All encodings other than these are private instructions for Motorola internal use only. Improper or unauthorized use of these instructions could result in potential internal damage to the device and can cause external signal contention since these tests operate internal registers, data path, and memory array logic and can drive random signal values on both the input and output pins.

9.1.2.1 EXTEST. The external test instruction (EXTEST) selects the 214-bit boundary scan register. The EXTEST instruction forces all output pins and bidirectional pins configured as outputs to the fixed values that are preloaded (with the PRELOAD instruction) and held in the boundary scan update registers. The EXTEST instruction can also be used to configure the direction of bidirectional pins and establish high-impedance states on some pins. The EXTEST instruction becomes active on the falling edge of TCK in the update-IR state when the data held in the instruction shift register is equivalent to \$0.

It is recommended that the boundary scan register bit equivalent to the \overline{RSTI} pin be preloaded with the assert value for system reset prior to application of the EXTEST instruction. This will ensure that EXTEST asserts the internal reset for the MC68060 system logic to force a predictable benign internal state while forcing all system output pins to fixed values. However, if it is desired to hold the processor in the LPSTOP state when applying the EXTEST instruction, do not preload the boundary scan register bit equivalent to the \overline{RSTI} pin with an assert value because this action forces the processor out of the LPSTOP state.

9.1.2.2 LPSAMPLE. The LPSAMPLE instruction provides identical functionality to the SAMPLE/PRELOAD instruction described in 9.1.2.4 SAMPLE/PRELOAD with one exception: instead of sampling the system data and control signals present at the MC68060 input pins, the LPSAMPLE instruction forces the LPSTOP isolation transistors into isolation state so that it can be verified that they are present and interrupting the path from the signal pin to the internal logic. The LPSAMPLE instruction becomes active on the falling edge of TCK in the update-IR state when the data held in the instruction shift register is equivalent to a \$1.

9.1.2.3 Private Instructions. The set of private instructions labeled MFG-TEST1 through MFG-TEST9 are reserved by Motorola for internal manufacturing use. These instructions can change (remap) the pin I/O and pin functions as defined for system operation (some input pins may become output pins and some output pins may become input pins). Use of these instructions without proper understanding can result in potentially destructive operation of the MC68060. These instructions become active on the falling edge of TCK in the update-IR state when the data held in the instructions shift register is equivalent to values \$2, \$3, \$8, \$9, \$A, \$B, \$C, \$D, and \$E.

9.1.2.4 SAMPLE/PRELOAD. The SAMPLE/PRELOAD instruction provides two separate functions. First, it provides a means to obtain a sample of the system data and control signals present at the MC68060 input pins and just prior to the boundary scan cell at the output pins. This sampling occurs on the rising edge of TCK in the capture-DR state when an instruction encoding of \$4 is resident in the instruction register. The user can observe this sampled data by shifting it through the boundary scan register to the output TDO by using the shift-DR state. Both the data capture and the shift operation are transparent to system operation. The user is responsible for providing some form of external synchronization to achieve meaningful results since there is no internal synchronization between TCK and the system clock, CLK.

The second function of the SAMPLE/PRELOAD instruction is to initialize the boundary scan register update cells before selecting EXTEST or CLAMP. This is accomplished by ignoring the data being shifted out of the TDO pin while shifting in initialization data. The update-DR state in conjunction with the falling edge of TCK can then be used to transfer this data to the update cells. This data will be applied to the external output pins when one of the instructions listed previously is applied.

9.1.2.5 IDCODE. The IDCODE instruction selects the 32-bit idcode register for connection as a shift path between the TDI pin and the TDO pin. This instruction allows the user to interrogate the MC68060 to determine its JTAG version number and other part identification data. The idcode register has been implemented in accordance with IEEE 1149.1 so that the least significant bit of the shift register stage is set to logic one on the rising edge of TCK following entry into the capture-DR state. Therefore, the first bit to be shifted out after selecting the idcode register is always a logic one (this is to differentiate a part that supports an idcode register from a part that supports only the bypass register). The remaining 31-bits are also set to fixed values (see **9.1.3.1 Idcode Register**) on the rising edge of TCK following entry into the capture-DR state.

The IDCODE instruction is the default value placed in the instruction register when a JTAG reset is accomplished by, either asserting $\overline{\text{TRST}}$, or holding TMS high while clocking TCK

IEEE 1149.1 Test (JTAG) and Debug Pipe Control Modes

through at least five rising edges and the falling edge after the fifth rising edge. A JTAG reset will cause the TAP state machine to enter the test-logic-reset state (normal operation of the TAP state machine into the test-logic-reset state will also result in placing the default value of \$5 into the instruction register). The shift register portion of the instruction register is loaded with the default value of \$5 when in the Capture-IR state and a rising edge of TCK occurs.

9.1.2.6 CLAMP. The CLAMP instruction selects the bypass register while simultaneously forcing all output pins and bidirectional pins configured as outputs, to the fixed values that are preloaded and held in the boundary scan update registers. This instruction enhances test efficiency by reducing the overall shift path to a single bit (the bypass register) while conducting an EXTEST type of instruction through the boundary scan register. The CLAMP instruction becomes active on the falling edge of TCK in the update-IR state when the data held in the instruction shift register is equivalent to \$6.

It is recommended that the boundary scan register bit equivalent to the $\overline{\text{RSTI}}$ pin be preloaded with the assert value for system reset prior to application of the CLAMP instruction. This will ensure that CLAMP asserts the internal reset for the MC68060 system logic to force a predictable benign internal state while isolating all pins from signals generated external to the part. However, if it is desired to hold the processor in the LPSTOP state when applying the CLAMP instruction, do not preload the boundary scan register bit equivalent to the $\overline{\text{RSTI}}$ pin with an assert value because this action forces the processor out of the LPSTOP state.

9.1.2.7 HIGHZ. The HIGHZ instruction is an IEEE 1149.1 option that is provided as a Motorola public instruction designed to anticipate the need to backdrive the output pins and protect the input pins from random toggling during circuit board testing. The HIGHZ instruction selects the bypass register, forces all output and bidirectional pins to the high-impedance state, and isolates all input signal pins except for CLK, IPL, and $\overline{\text{RSTI}}$. The HIGHZ instruction becomes active on the falling edge of TCK in the update-IR state when the data held in the instruction shift register is equivalent to \$7.

It is recommended that the boundary scan register bit equivalent to the $\overline{\text{RSTI}}$ pin be preloaded with the assert value for system reset prior to application of the HIGHZ instruction. This will ensure that HIGHZ asserts the internal reset for the MC68060 system logic to force a predictable benign internal state while isolating all pins from signals generated external to the part.

9.1.2.8 BYPASS. The BYPASS instruction selects the single-bit bypass register, creating a single bit shift register path from the TDI pin to the bypass register to the TDO pin. This instruction enhances test efficiency by reducing the overall shift path when a device other than the MC68060 becomes the device under test on a board design with multiple chips on the overall IEEE-1149.1-defined boundary scan chain. The bypass register has been implemented in accordance with IEEE 1149.1 so that the shift register stage is set to logic zero on the rising edge of TCK following entry into the capture-DR state. Therefore, the first bit to be shifted out after selecting the bypass register is always a logic zero (this is to differentiate a part that supports an idcode register from a part that supports only the bypass register).

IEEE 1149.1 Test (JTAG) and Debug Pipe Control Modes

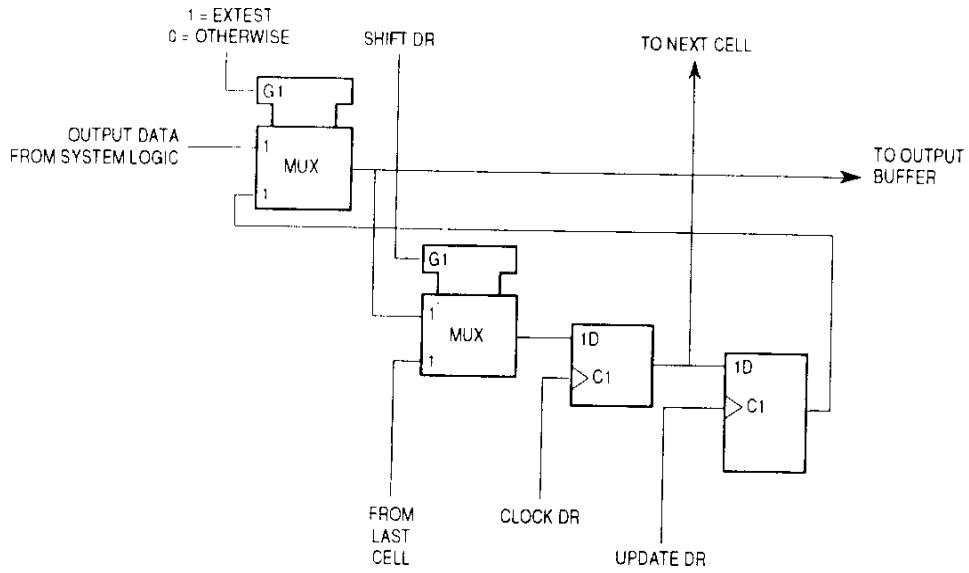

Figure 9-3. Output Pin Cell (O.Pin)

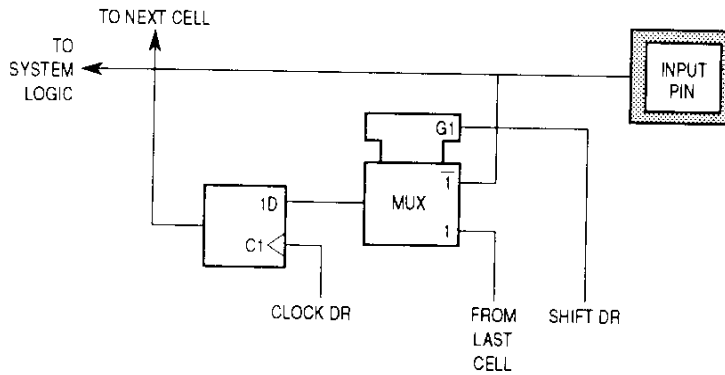

Figure 9-4. Observe-Only Input Pin Cell (I.Obs)

Freescale Semiconductor, Inc.

9

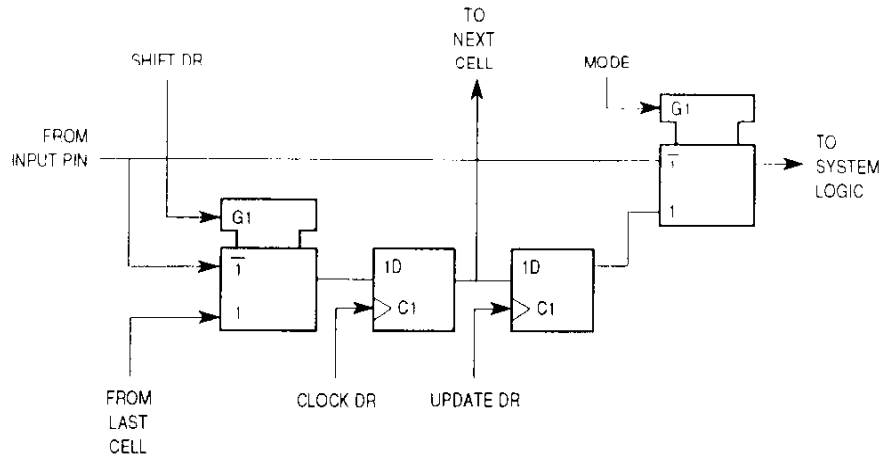

Figure 9-5. Input Pin Cell (I.Pin)

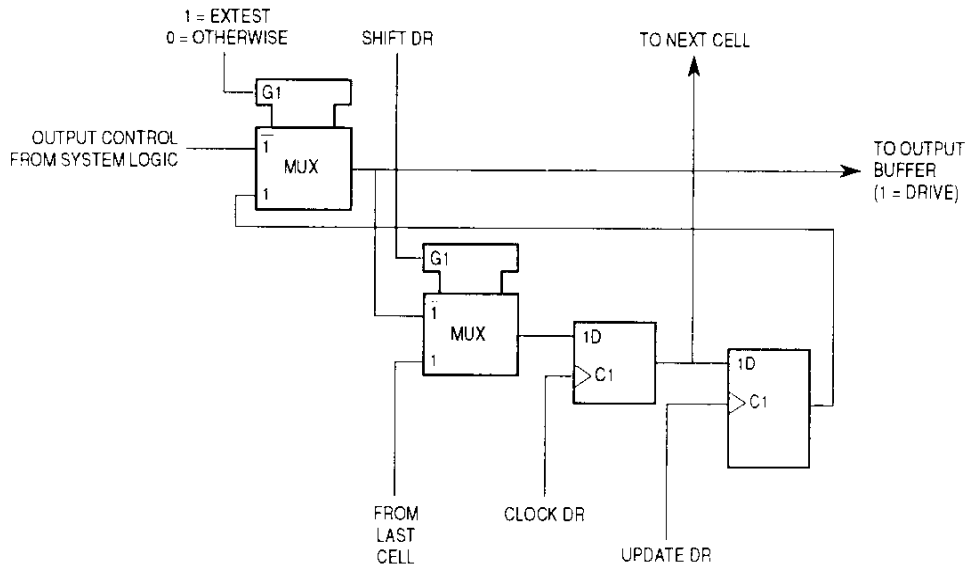

Figure 9-6. Output Control Cell (IO.CtI)

IEEE 1149.1 Test (JTAG) and Debug Pipe Control Modes

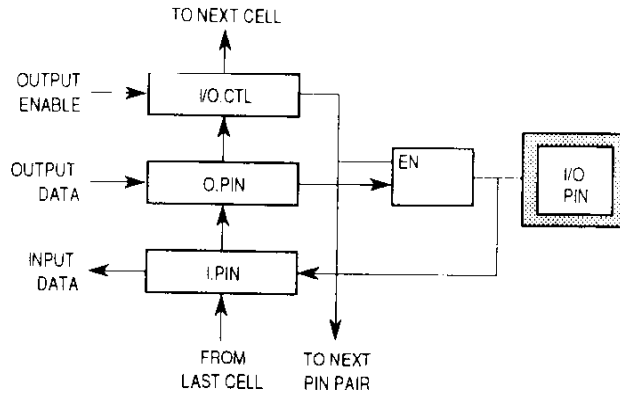

Figure 9-7. General Arrangement of Bidirectional Pin Cells

Table 9-3. Boundary Scan Bit Definitions

Bit	Cell Type	Pin/Cell Name	Pin Type
0	O.Pin	A31	I/O
1	I.Pin	A31	I/O
2	O.Pin	A30	I/O
3	I.Pin	A30	I/O
4	IO.CtI	A31–A28 ena	—
5	O.Pin	A29	I/O
6	I.Pin	A29	I/O
7	O.Pin	A28	I/O
8	I.Pin	A28	I/O
9	O.Pin	A27	I/O
10	I.Pin	A27	I/O
11	O.Pin	A26	I/O
12	I.Pin	A26	I/O
13	IO.CtI	A27–A24 ena	—
14	O.Pin	A25	I/O
15	I.Pin	A25	I/O
16	O.Pin	A24	I/O
17	I.Pin	A24	I/O
18	O.Pin	A23	I/O
19	I.Pin	A23	I/O
20	O.Pin	A22	I/O
21	I.Pin	A22	I/O
22	IO.CtI	A23–A20 ena	—
23	O.Pin	A21	I/O
24	I.Pin	A21	I/O
25	O.Pin	A20	I/O
26	I.Pin	A20	I/O
27	O.Pin	A19	I/O
28	I.Pin	A19	I/O
29	O.Pin	A18	I/O
30	I.Pin	A18	I/O
31	IO.CtI	A19–A16 ena	—



Table 9-3. Boundary Scan Bit Definitions (Continued)

Bit	Cell Type	Pin/Cell Name	Pin Type
32	O.Pin	A17	I/O
33	I.Pin	A17	I/O
34	O.Pin	A16	I/O
35	I.Pin	A16	I/O
36	O.Pin	A15	I/O
37	I.Pin	A15	I/O
38	O.Pin	A14	I/O
39	I.Pin	A14	I/O
40	IO.Ctl	A15-A12 ena	—
41	O.Pin	A13	I/O
42	I.Pin	A13	I/O
43	O.Pin	A12	I/O
44	I.Pin	A12	I/O
45	O.Pin	A11	I/O
46	I.Pin	A11	I/O
47	O.Pin	A10	I/O
48	I.Pin	A10	I/O
49	IO.Ctl	A11-A10, TT1-TT0 ena	—
50	O.Pin	TT1	I/O
51	I.Pin	TT1	I/O
52	O.Pin	TT0	Output
53	I.Obs	MTM1	I
54	O.Pin	UPA1	Output
55	O.Pin	UPA0	Output
56	IO.Ctl	UPA1-UPA0, XCIOUT ena	—
57	O.Pin	XCIOUT	Output
58	O.Pin	XIPEND	Output
59	O.Pin	XRSTO	Output
60	IO.Ctl	XIPEND, XRSTO ena	—
61	O.Pin	XBS0	Output
62	O.Pin	XBS1	Output
63	IO.Ctl	XBS3-XBS0 ena	—
64	O.Pin	XBS2	Output
65	O.Pin	XBS3	Output
66	I.Pin	XMDIS	Input
67	I.Pin	XCDIS	Input
68	I.Pin	XRSTI	Input
69	I.Pin	XIPL2	Input
70	I.Pin	XIPL1	Input
71	I.Pin	XIPL0	Input
72	I.Pin	XCLKEN	Input
73	I.Obs	CLK	Input
74	I.Obs	MTM2	Input
75	I.Pin	XTCI	Input
76	I.Pin	XAVEC	Input
77	I.Pin	XIBI	Input
78	I.Pin	XBGR	Input
79	I.Pin	XBG	Input
80	I.Pin	XTRA	Input

Table 9-3. Boundary Scan Bit Definitions (Continued)

Bit	Cell Type	Pin/Cell Name	Pin Type
81	I.Pin	XTEA	Input
82	I.Pin	XTA	Input
83	O.Pin	PST0	Output
84	O.Pin	PST1	Output
85	O.Pin	PST2	Output
86	IO.Ctl	PST4–PST0, XBR ena	—
87	O.Pin	PST3	Output
88	O.Pin	PST4	Output
89	O.Pin	XSAS	Output
90	IO.Ctl	XSAS ena	—
91	O.Pin	XBTT	I/O
92	IO.Ctl	XBTT ena	—
93	I.Pin	XBTT	I/O
94	O.Pin	XTS	I/O
95	I.Pin	XTS ena	—
96	I.Pin	XTS	I/O
97	O.Pin	XTIP	Output
98	IO.Ctl	XTIP ena	—
99	I.Pin	XSNOOP	Input
100	O.Pin	XBB	I/O
101	IO.Ctl	XBB ena	—
102	I.Pin	XBB	I/O
103	O.Pin	XBR	Output
104	IO.Ctl	XLOCK, XLOCKE ena	—
105	O.Pin	XLOCK	Output
106	O.Pin	XLOCKE	Output
107	O.Pin	TLN0	Output
108	O.Pin	SIZ0	Output
109	IO.Ctl	TLN0, SIZ1–SIZ0, XR_W ena	—
110	O.Pin	SIZ1	Output
111	O.Pin	XR_W	Output
112	O.Pin	TLN1	Output
113	O.Pin	TM0	Output
114	IO.Ctl	TLN1, TM2–TM0 ena	—
115	O.Pin	TM1	Output
116	O.Pin	TM2	Output
117	O.Pin	A0	I/O
118	I.Pin	A0	I/O
119	O.Pin	A1	I/O
120	I.Pin	A1	I/O
121	IO.Ctl	A1–A0 ena	—
122	I.Pin	XCLA	—
123	O.Pin	A2	I/O
124	I.Pin	A2	I/O
125	O.Pin	A3	I/O
126	I.Pin	A3	I/O
127	IO.Ctl	A3–A2 ena	—
128	O.Pin	A4	I/O
129	I.Pin	A4	I/O

Table 9-3. Boundary Scan Bit Definitions (Continued)

Bit	Cell Type	Pin/Cell Name	Pin Type
130	O.Pin	A5	I/O
131	I.Pin	A5	I/O
132	IO.Ctl	A5-A4 ena	—
133	O.Pin	A6	I/O
134	I.Pin	A6	I/O
135	O.Pin	A7	I/O
136	I.Pin	A7	I/O
137	IO.Ctl	A9-A6 ena	—
138	O.Pin	A8	I/O
139	I.Pin	A8	I/O
140	O.Pin	A9	I/O
141	I.Pin	A9	I/O
142	O.Pin	D31	I/O
143	I.Pin	D31	I/O
144	O.Pin	D30	I/O
145	I.Pin	D30	I/O
146	IO.Ctl	D31-D28 ena	—
147	O.Pin	D29	I/O
148	I.Pin	D29	I/O
149	O.Pin	D28	I/O
150	I.Pin	D28	I/O
151	O.Pin	D27	I/O
152	I.Pin	D27	I/O
153	O.Pin	D26	I/O
154	I.Pin	D26	I/O
155	IO.Ctl	D27-D24 ena	—
156	O.Pin	D25	I/O
157	I.Pin	D25	I/O
158	O.Pin	D24	I/O
159	I.Pin	D24	I/O
160	O.Pin	D23	I/O
161	I.Pin	D23	I/O
162	O.Pin	D22	I/O
163	I.Pin	D22	I/O
164	IO.Ctl	D23-D20 ena	—
165	O.Pin	D21	I/O
166	I.Pin	D21	I/O
167	O.Pin	D20	I/O
168	I.Pin	D20	I/O
169	O.Pin	D19	I/O
170	I.Pin	D19	I/O
171	O.Pin	D18	I/O
172	I.Pin	D18	I/O
173	IO.Ctl	D19-D16 ena	—
174	O.Pin	D17	I/O
175	I.Pin	D17	I/O
176	O.Pin	D16	I/O
177	I.Pin	D16	I/O
178	O.Pin	D15	I/O

Table 9-3. Boundary Scan Bit Definitions (Continued)

Bit	Cell Type	Pin/Cell Name	Pin Type
179	I.Pin	D15	I/O
180	O.Pin	D14	I/O
181	I.Pin	D14	I/O
182	IO.Ctl	D15–D12 ena	—
183	O.Pin	D13	I/O
184	I.Pin	D13	I/O
185	O.Pin	D12	I/O
186	I.Pin	D12	I/O
187	O.Pin	D11	I/O
188	I.Pin	D11	I/O
189	O.Pin	D10	I/O
190	I.Pin	D10	I/O
191	IO.Ctl	D11–D8 ena	—
192	O.Pin	D9	I/O
193	I.Pin	D9	I/O
194	O.Pin	D8	I/O
195	I.Pin	D8	I/O
196	O.Pin	D7	I/O
197	I.Pin	D7	I/O
198	O.Pin	D6	I/O
199	I.Pin	D6	I/O
200	IO.Ctl	D7–D4 ena	—
201	O.Pin	D5	I/O
202	I.Pin	D5	I/O
203	O.Pin	D4	I/O
204	I.Pin	D4	I/O
205	O.Pin	D3	I/O
206	I.Pin	D3	I/O
207	O.Pin	D2	I/O
208	I.Pin	D2	I/O
209	IO.Ctl	D3–D0 ena	—
210	O.Pin	D1	I/O
211	I.Pin	D1	I/O
212	O.Pin	D0	I/O
213	I.Pin	D0	I/O

9.1.3.3 BYPASS REGISTER. An IEEE-1149.1-compliant bypass register has been included on the MC68060. This register is a single bit in depth when connected between TDI and TDO. The register element is in the shift path which operates during rising edges of TCK while the TAP state machine is in the shift-DR state or captures a default state of logic 0 during the rising edge of TCK while the TAP state machine is in the capture-DR state.

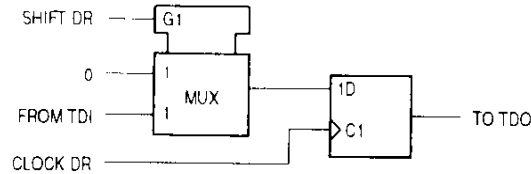

Figure 9-8. JTAG Bypass Register

9.1.4 Restrictions

The test logic is implemented using static logic design, and TCK can be stopped in either a high or low state without loss of data. The system logic, however, operates on a different system clock which is not synchronized to TCK internally. Any mixed operation requiring the use of 1149.1 test logic in conjunction with system functional logic that uses both clocks, must have coordination and synchronization of these clocks done externally to the MC68060.

The MC68060 also includes an internal instruction known as LPSTOP which can place the output pins in a high-impedance state, isolate the input pins from their internal signals, and stop the internal clock. Special care must be taken to ensure that the JTAG logic does not consume excess power during this mode if it is to be left inactive (see **9.1.5 Disabling the IEEE 1149.1 Standard Operation**).

9.1.5 Disabling the IEEE 1149.1 Standard Operation

There are two methods by which the device can be used without the IEEE 1149.1 test logic being active: 1) non-use of the JTAG test logic by either non-termination (disconnection) or intentional fixing of TAP logic values, and 2) intentional disabling of the JTAG test logic by assertion of the $\overline{\text{JTAG}}$ signal.

There are several considerations that must be addressed if the IEEE 1149.1 logic is not going to be used once the MC68060 is assembled onto a board. The prime consideration is to ensure that the IEEE 1149.1 test logic remains transparent and benign to the system logic during functional operation. This requires the minimum of either connecting the $\overline{\text{TRST}}$ pin to logic 0, or connecting the TCK clock pin to a clock source that will supply five rising edges and the falling edge after the fifth rising edge, to ensure that the part enters the test-logic-reset state. The recommended solution is to connect $\overline{\text{TRST}}$ to logic 0 since logic was included to ensure that unterminated or fixed-value terminated pins consume the least power during the LPSTOP functional state. Another consideration is that the TCK pin does not have a pullup as is required on the TMS, TDI, and $\overline{\text{TRST}}$ pins; therefore, it should not be left unterminated to preclude mid-level input values.

IEEE 1149.1 Test (JTAG) and Debug Pipe Control Modes

A second method of using the MC68060 without the IEEE 1149.1 logic being active is to select the alternate complementary test debug emulation mode by placing a logic 1 on the defined compliance enable pin, $\overline{\text{JTAG}}$. When the $\overline{\text{JTAG}}$ is asserted, then the IEEE 1149.1 test controller is placed in the test-logic-reset state by applying a logic 0 on the internal $\overline{\text{TRST}}$ signal to the controller, and the TAP pins are remapped to their equivalent debug emulation mode pins.

NOTE

The MC68060 supports the low-power stop mode which can isolate the input and output signal pins from their internal connections and allows the internal system clock to be stopped. In accordance with IEEE 1149.1, the JTAG logic can become the chip master during this functional mode and can conduct test operations. During this type of testing, the MC68060 will consume power at a level higher than that specified for functional LPSTOP mode. If the JTAG mode is left active, but is not being actively used to conduct test operations, the MC68060 will consume power at a level below the rated LPSTOP maximum but not at the lowest possible level. In order to consume the least possible power, the JTAG logic must be specifically disabled by placing a logic 0 on the $\overline{\text{TRST}}$ pin and a logic 1 on the TMS pin, as shown in Figure 9-9.

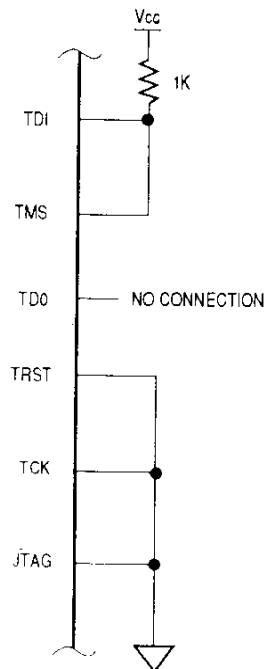

Figure 9-9. Circuit Disabling IEEE Standard 1149.1

9.1.6 Motorola MC68060 BSDL Description

```

Version 1.0 02-18-94
Revision List: None
Package Type: 18 x 18 PGA
entity MC68060 is
generic(PHYSICAL_PIN_MAP:string := "PGA_18x18");

port (
    TDI:    in        bit;
    TDO:    out       bit;
    TMS:    in        bit;
    TCK:    in        bit;
    TRST:   in        bit;
    D:      inout    bit_vector(0 to 31);
    A:      inout    bit_vector(0 to 31);
    CIA:    in        bit;
    TM:     out       bit_vector(0 to 2);
    TLN:    out       bit_vector(0 to 1);
    R_W:    out       bit;
    SIZ:    out       bit_vector(0 to 1);
    LOCKE:  out       bit;
    LOCK:   out       bit;
    BR:     out       bit;
    BB:     inout    bit;
    SNOOP:  in        bit;
    TIP:    out       bit;
    TS:     inout    bit;
    BTT:    inout    bit;
    SAS:    out       bit;
    PST:    out       bit_vector(0 to 4);
    TA:     in        bit;
    TEA:    in        bit;
    TRA:    in        bit;
    BG:     in        bit;
    BGR:    in        bit;
    TBI:    in        bit;
    AVEC:   in        bit;
    PCI:    in        bit;
    CLK:    in        bit;
    CLKEN:  in        bit;
    IPL:    in        bit_vector(0 to 2);
    RSTI:   in        bit;
    CDIS:   in        bit;
    MDIS:   in        bit;
    BS:     out       bit_vector(0 to 3);
    RSTO:   out       bit;
    IPEND:  out       bit;
    CIOUT:  out       bit;
    UPA:    out       bit_vector(0 to 1);
    TT1:    inout    bit;
    TTC:    out       bit;
    JTAGENB: in       bit_vector(0 to 2);
    THERM1: linkage  bit;
    THERM0: linkage  bit;
    EVDD:   linkage  bit_vector(1 to 25);

```

IEEE 1149.1 Test (JTAG) and Debug Pipe Control Modes

```

EVM3:    linkage bit_vector(1 to 25);
IVDD:    linkage bit_vector(1 to 16);
IVSS:    linkage bit_vector(1 to 16);
);

use STD_1149_1_1994.all;
attribute COMPONENT_CONFORMANCE of MC68060: entity is "STD_1149_1_1993";

attribute PIN_MAP of MC68060 : entity is PHYSICAL_PIN_MAP;

-- PGA_18x18 Pin Map
--
-- No-connects:  D4,  D5, D6, D7, D9, D11, D13, D14, K4, M4, N4, Q16, R7,
                 R10, S12, T9, T12

constant PGA_18x18 : PIN_MAP_STRING :=
"TDI:      S3, " &
"IDO:      T2, " &
"TMS:      S5, " &
"TCK:      S4, " &
"TRST:     T3, " &
--
--      0      1      2      3      4      5      6      7      8      9      10     11
"D:      ( C3,  B3,  C4,  A2,  A3,  A4,  A5,  A6,  B7,  A7,  A8,  A9, " &
--      12     13     14     15     16     17     18     19     20     21     22     23
--      A10, A11, A12, A13, B11, A14, B12, A15, A16, A17, B16, C15, " &
--      24     25     26     27     28     29     30     31
--      A18, C16, B18, D16, C18, E16, E17, D18 ), " &
--      0      1      2      3      4      5      6      7      8      9      10     11
"A:      ( L18, K18, J17, J18, H18, G18, G16, F18, E18, F16, P1, N3, " &
--      12     13     14     15     16     17     18     19     20     21     22     23
--      N1,  M1,  L1,  K1,  K2,  J1,  H1,  J2,  G1,  F1,  E1,  G3, " &
--      24     25     26     27     28     29     30     31
--      D1,  F3,  E2,  C1,  E3,  B1,  D3,  A1 ), " &
"CLA:     K15, " &
"TM:      ( N18, M18, K17 ), " &
"TLN:     ( Q18, P18 ), " &
"R_W:     N16, " &
"SI2:     ( P17, P16 ), " &
"LOCKE:   R18, " &
"LOCK:    S18, " &
"BR:      T18, " &
"BB:      T17, " &
"SNOOP:   P15, " &
"TIP:     R15, " &
"TS:      R16, " &
"BTT:     Q15, " &
"SAS:     Q14, " &
"PST:     ( T15, S14, R14, T16, Q13 ), " &
"TA:      T14, " &
"TEA:     S13, " &
"TRA:     Q12, " &
"EG:      T13, " &
"BGR:     Q11, " &
"BTI:     S11, " &
"AVEC:    T11, " &

```

```

"TDI:      T18, " &
"JTAGENB0: ( T4, F15, S10 ), " &
"TRST:     P9, " &
"TRSTEN:   Q8, " &
"TRSTEN:   ( T8, T7, T6 ), " &
"RSTEN:    E7, " &
"CE10:     T5, " &
"MD10:     S6, " &
"EC1:      ( Q4, Q5, Q6, Q7 ), " &
"RSTEN:    R3, " &
"JPEND:    S1, " &
"C1OUT:    R1, " &
"UPA:      ( Q3, Q1 ), " &
"TT1:      P2, " &
"TT0:      P3, " &
"THERM1:   M15, " &
"THERM0:   L15, " &

"EMID:     ( B5, B9, B14, C2, C17, D8, D10, D12, D15, E4, G2, " &
"          G4, G15, G17, J4, J15, L4, M2, M17, N15, P4, Q10, " &
"          R2, R17, S16 ), " &
"EVSS:     ( B2, B4, B6, B8, B10, B13, B15, B17, D2, D17, F2, " &
"          F4, F17, H2, H17, L2, L17, N2, N17, Q2, Q9, Q17, " &
"          S2, S15, S17 ), " &
"IVDD:     ( C5, C8, C10, C12, C14, E15, H3, H16, J3, J16, L16, " &
"          M3, R5, R8, R12, S8 ), " &
"IVSS:     ( C6, C7, C9, C11, C13, H4, H15, K3, K16, L3, M16, " &
"          R4, R6, R11, R13, S9 ) ";

```

-- Other Pin Maps here

```

attribute TAP_SCAN_IN of TDI:signal is true;
attribute TAP_SCAN_OUT of TDO:signal is true;
attribute TAP_SCAN_MODE of TMS:signal is true;
attribute TAP_SCAN_CLOCK of TCK:signal is (33.0e6, BOTH);
attribute TAP_SCAN_RESET of TRST:signal is true;

attribute COMPLIANCE_ENABLE of JTAGENB(0): signal is true;
attribute COMPLIANCE_ENABLE of JTAGENB(1): signal is true;
attribute COMPLIANCE_ENABLE of JTAGENB(2): signal is true;

attribute COMPLIANCE_PATTERNS of MC68060: entity is
    "(JTAGENB(0), JTAGENB(1), JTAGENB(2)) (000)";

attribute INSTRUCTION_LENGTH of MC68060:entity is 4;

attribute INSTRUCTION_OPCODE of MC68060:entity is
"EXTST (0000)," &
"1PSAMPLE (0001)," &
"SAMPLE (0100)," &
"IDCODE (0101)," &
"CLAMP (0110)," &
"HIGHZ (0111)," &
"PRIVATE (0010, 0011, 1000, 1001, 1010, 1011, 1100, 1101, 1110)," &
"BYPASS (1111)";

```

IEEE 1149.1 Test (JTAG) and Debug Pipe Control Modes

```
attribute INSTRUCTION_CAPTURE of MC68060:entity is "0161";
attribute INSTRUCTION_PRIVATE of MC68060:entity is "PRIVATE";
attribute REGISTER_ACCESS of MC68060:entity is
  "BOUNDARY (LPSAMPLE)";
```

```
attribute IDCODE_REGISTER of MC68060:entity is
  "0061" &          -- version
  "000001" &        -- design center
  "0000110000" &    -- sequence number
  "000000011110" & -- Motorola
  "1";              -- required by 1149.1
```

```
attribute BOUNDARY_CELLS of MC68060:entity is
  "BC_1, BC_2, BC_4";
```

```
attribute BOUNDARY_LENGTH of MC68060:entity is 214;
```

```
attribute BOUNDARY_REGISTER of MC68060:entity is
--num cell port      function safe ccell dsval rsit
"0  (BC_1, D(0),      input,   X),    " &
"1  (BC_2, D(0),      output3, X,     4,    0,   Z), " &
"2  (BC_1, D(1),      input,   X),    " &
"3  (BC_2, D(1),      output3, X,     4,    0,   Z), " &
"4  (BC_2, *,         control, 0),    " & -- d[3:0]
"5  (BC_1, D(2),      input,   X),    " &
"6  (BC_2, D(2),      output3, X,     4,    0,   Z), " &
"7  (BC_1, D(3),      input,   X),    " &
"8  (BC_2, D(3),      output3, X,     4,    0,   Z), " &
"9  (BC_1, D(4),      input,   X),    " &
"10 (BC_2, D(4),      output3, X,    13,    0,   Z), " &
"11 (BC_1, D(5),      input,   X),    " &
"12 (BC_2, D(5),      output3, X,    13,    0,   Z), " &
"13 (BC_2, *,         control, 0),    " & -- d[7:4]
"14 (BC_1, D(6),      input,   X),    " &
"15 (BC_2, D(6),      output3, X,    13,    0,   Z), " &
"16 (BC_1, D(7),      input,   X),    " &
"17 (BC_2, D(7),      output3, X,    13,    0,   Z), " &
"18 (BC_1, D(8),      input,   X),    " &
"19 (BC_2, D(8),      output3, X,    22,    0,   Z), " &
--num cell port      function safe ccell dsval rsit
"20 (BC_1, D(9),      input,   X),    " &
"21 (BC_2, D(9),      output3, X,    22,    0,   Z), " &
"22 (BC_2, *,         control, 0),    " & -- d[11:8]
"23 (BC_1, D(10),     input,   X),    " &
"24 (BC_2, D(10),     output3, X,    22,    0,   Z), " &
"25 (BC_1, D(11),     input,   X),    " &
"26 (BC_2, D(11),     output3, X,    22,    0,   Z), " &
"27 (BC_1, D(12),     input,   X),    " &
"28 (BC_2, D(12),     output3, X,    31,    0,   Z), " &
"29 (BC_1, D(13),     input,   X),    " &
"30 (BC_2, D(13),     output3, X,    31,    0,   Z), " &
"31 (BC_2, *,         control, 0),    " & -- d[15:12]
"32 (BC_1, D(14),     input,   X),    " &
"33 (BC_3, D(14),     output3, X,    31,    0,   Z), " &
```

IEEE 1149.1 Test (JTAG) and Debug Pipe Control Modes

```

"34 (BC_1, D(15), input, X), " &
"35 (BC_2, D(15), output3, X, 31, 0, Z), " &
"36 (BC_1, D(16), input, X), " &
"37 (BC_2, D(16), output3, X, 40, 0, Z), " &
"38 (BC_1, D(17), input, X), " &
"39 (BC_2, D(17), output3, X, 40, 0, Z), " &
--num cell port function safe ccell dsval rslt
"40 (BC_2, *, control, 0), " & -- d[19:16]
"41 (BC_1, D(18), input, X), " &
"42 (BC_2, D(18), output3, X, 40, 0, Z), " &
"43 (BC_1, D(19), input, X), " &
"44 (BC_2, D(19), output3, X, 40, 0, Z), " &
"45 (BC_1, D(20), input, X), " &
"46 (BC_2, D(20), output3, X, 49, 0, Z), " &
"47 (BC_1, D(21), input, X), " &
"48 (BC_2, D(21), output3, X, 49, 0, Z), " &
"49 (BC_2, *, control, 0), " & -- d[23:20]
"50 (BC_1, D(22), input, X), " &
"51 (BC_2, D(22), output3, X, 49, 0, Z), " &
"52 (BC_1, D(23), input, X), " &
"53 (BC_2, D(23), output3, X, 49, 0, Z), " &
"54 (BC_1, D(24), input, X), " &
"55 (BC_2, D(24), output3, X, 58, 0, Z), " &
"56 (BC_1, D(25), input, X), " &
"57 (BC_2, D(25), output3, X, 58, 0, Z), " &
"58 (BC_2, *, control, 0), " & -- d[27:24]
"59 (BC_1, D(26), input, X), " &
--num cell port function safe ccell dsval rslt
"60 (BC_2, D(26), output3, X, 58, 0, Z), " &
"61 (BC_1, D(27), input, X), " &
"62 (BC_2, D(27), output3, X, 58, 0, Z), " &
"63 (BC_1, D(28), input, X), " &
"64 (BC_2, D(28), output3, X, 67, 0, Z), " &
"65 (BC_1, D(29), input, X), " &
"66 (BC_2, D(29), output3, X, 67, 0, Z), " &
"67 (BC_2, *, control, 0), " & -- d[31:28]
"68 (BC_1, D(30), input, X), " &
"69 (BC_2, D(30), output3, X, 67, 0, Z), " &
"70 (BC_1, D(31), input, X), " &
"71 (BC_2, D(31), output3, X, 67, 0, Z), " &
"72 (BC_1, A(9), input, X), " &
"73 (BC_2, A(9), output3, X, 76, 0, Z), " &
"74 (BC_1, A(8), input, X), " &
"75 (BC_2, A(8), output3, X, 76, 0, Z), " &
"76 (BC_2, *, control, 0), " & -- a[9:6]
"77 (BC_1, A(7), input, X), " &
"78 (BC_2, A(7), output3, X, 76, 0, Z), " &
"79 (BC_1, A(6), input, X), " &
--num cell port function safe ccell dsval rslt
"80 (BC_2, A(6), output3, X, 76, 0, Z), " &
"81 (BC_2, *, control, 0), " & -- a[5:4]
"82 (BC_1, A(5), input, X), " &
"83 (BC_2, A(5), output3, X, 81, 0, Z), " &
"84 (BC_1, A(4), input, X), " &
"85 (BC_2, A(4), output3, X, 81, 0, Z), " &

```

IEEE 1149.1 Test (JTAG) and Debug Pipe Control Modes

```

"86 (BC_2, *, control, 0), " & a[1:0]
"87 (BC_1, A(3), input, X), " &
"88 (BC_2, A(3), output3, X, 86, 0, Z), " &
"89 (BC_1, A(2), input, X), " &
"90 (BC_2, A(2), output3, X, 86, 0, Z), " &
"91 (BC_1, CIA, input, X), " &
"92 (BC_2, *, control, 0), " & a[1:0]
"93 (BC_1, A(1), input, X), " &
"94 (BC_2, A(1), output3, X, 92, 0, Z), " &
"95 (BC_1, A(0), input, X), " &
"96 (BC_2, A(0), output3, X, 92, 0, Z), " &
"97 (BC_2, TM(2), output3, X, 99, 0, Z), " &
"98 (BC_2, TM(1), output3, X, 99, 0, Z), " &
"99 (BC_2, *, control, 0), " & -- tln(1),tm[2:0]
--num cell port function safe ccell dsval rslt
"100 (BC_2, TM(0), output3, X, 99, 0, Z), " &
"101 (BC_2, TLN(1), output3, X, 99, 0, Z), " &
"102 (BC_2, R_W, output3, X, 104, 0, Z), " &
"103 (BC_2, SIZ(1), output3, X, 104, 0, Z), " &
"104 (BC_2, *, control, 0), " & -- tin(0),siz[1:0]
"105 (BC_2, SIZ(0), output3, X, 104, 0, Z), " &
"106 (BC_2, TLN(0), output3, X, 104, 0, Z), " &
"107 (BC_2, LOCKE, output3, X, 109, 0, Z), " &
"108 (BC_2, LOCK, output3, X, 109, 0, Z), " &
"109 (BC_2, *, control, 0), " & -- lock,locke
"110 (BC_2, BR, output3, X, 127, 0, Z), " &
"111 (BC_1, BB, input, X), " &
"112 (BC_2, *, control, 0), " & -- bb
"113 (BC_2, BB, output3, X, 112, 0, Z), " &
"114 (BC_1, SNOOP, input, X), " &
"115 (BC_2, *, control, 0), " & -- tip
"116 (BC_2, TIP, output3, X, 115, 0, Z), " &
"117 (BC_1, TS, input, X), " &
"118 (BC_2, *, control, 0), " & -- ts
"119 (BC_2, TS, output3, X, 118, 0, Z), " &
--num cell port function safe ccell dsval rslt
"120 (BC_1, BTT, input, X), " &
"121 (BC_2, *, control, 0), " & -- btt
"122 (BC_2, BTT, output3, X, 121, 0, Z), " &
"123 (BC_2, *, control, 0), " & -- sas
"124 (BC_2, SAS, output3, X, 123, 0, Z), " &
"125 (BC_2, PST(4), output3, X, 127, 0, Z), " &
"126 (BC_2, PST(3), output3, X, 127, 0, Z), " &
"127 (BC_2, *, control, 0), " & -- pst[4:0],br
"128 (BC_2, PST(2), output3, X, 127, 0, Z), " &
"129 (BC_2, PST(1), output3, X, 127, 0, Z), " &
"130 (BC_2, PST(0), output3, X, 127, 0, Z), " &
"131 (BC_1, TA, input, X), " &
"132 (BC_1, TEA, input, X), " &
"133 (BC_1, TFA, input, X), " &
"134 (BC_1, BG, input, X), " &
"135 (BC_1, RGR, input, X), " &
"136 (BC_1, TR1, input, X), " &
"137 (BC_1, AVEN, input, X), " &
"138 (BC_1, TR1, input, X), " &

```

IEEE 1149.1 Test (JTAG) and Debug Pipe Control Modes

```

"139 (BC_2, *, internal, X), " &
--num cell port function safe ccell dsval rslt
"140 (BC_4, CLK, input, X), " &
"141 (BC_1, CLKEN, input, X), " &
"142 (BC_1, IPL(0), input, X), " &
"143 (BC_1, IPL(1), input, X), " &
"144 (BC_1, IPL(2), input, X), " &
"145 (BC_1, RSTI, input, X), " &
"146 (BC_1, CDIS, input, X), " &
"147 (BC_1, MDIS, input, X), " &
"148 (BC_2, BS(3), output3, X, 150, 0, Z), " &
"149 (BC_2, BS(2), output3, X, 150, 0, Z), " &
"150 (BC_2, *, control, 0), " & -- bs[3:0]
"151 (BC_2, BS(1), output3, X, 150, 0, Z), " &
"152 (BC_2, BS(0), output3, X, 150, 0, Z), " &
"153 (BC_2, *, control, 0), " & -- ipend,rsto
"154 (BC_2, RSTO, output3, X, 153, 0, Z), " &
"155 (BC_2, IPEND, output3, X, 153, 0, Z), " &
"156 (BC_2, CIOUT, output3, X, 157, 0, Z), " &
"157 (BC_2, *, control, 0), " & -- upa[1:0],ciout
"158 (BC_2, UPA(0), output3, X, 157, 0, Z), " &
"159 (BC_2, UPA(1), output3, X, 157, 0, Z), " &
--num cell port function safe ccell dsval rslt
"160 (BC_2, *, internal, X), " &
"161 (BC_2, TT0, output3, X, 164, 0, Z), " &
"162 (BC_1, TT1, input, X), " &
"163 (BC_2, TT1, output3, X, 164, 0, Z), " &
"164 (BC_2, *, control, 0), " & -- a[11:10],TT[1:0]
"165 (BC_1, A(10), input, X), " &
"166 (BC_2, A(10), output3, X, 164, 0, Z), " &
"167 (BC_1, A(11), input, X), " &
"168 (BC_2, A(11), output3, X, 164, 0, Z), " &
"169 (BC_1, A(12), input, X), " &
"170 (BC_2, A(12), output3, X, 173, 0, Z), " &
"171 (BC_1, A(13), input, X), " &
"172 (BC_2, A(13), output3, X, 173, 0, Z), " &
"173 (BC_2, *, control, 0), " & -- a[15:12]
"174 (BC_1, A(14), input, X), " &
"175 (BC_2, A(14), output3, X, 173, 0, Z), " &
"176 (BC_1, A(15), input, X), " &
"177 (BC_2, A(15), output3, X, 173, 0, Z), " &
"178 (BC_1, A(16), input, X), " &
"179 (BC_2, A(16), output3, X, 182, 0, Z), " &
--num cell port function safe ccell dsval rslt
"180 (BC_1, A(17), input, X), " &
"181 (BC_2, A(17), output3, X, 182, 0, Z), " &
"182 (BC_2, *, control, 0), " & -- a[19:16]
"183 (BC_1, A(18), input, X), " &
"184 (BC_2, A(18), output3, X, 182, 0, Z), " &
"185 (BC_1, A(19), input, X), " &
"186 (BC_2, A(19), output3, X, 182, 0, Z), " &
"187 (BC_1, A(20), input, X), " &
"188 (BC_2, A(20), output3, X, 191, 0, Z), " &
"189 (BC_1, A(21), input, X), " &
"190 (BC_2, A(21), output3, X, 191, 0, Z), " &

```

IEEE 1149.1 Test (JTAG) and Debug Pipe Control Modes

```

"191 (BC_2, *, control, 0), " & -- a[19:19]
"192 (BC_1, A(22), input, X), " & -- a[19:20]
"193 (BC_2, A(22), output3, X, 191, 0, Z), " &
"194 (BC_1, A(23), input, X), " &
"195 (BC_2, A(23), output3, X, 191, 0, Z), " &
"196 (BC_1, A(24), input, X), " &
"197 (BC_2, A(24), output3, X, 200, 0, Z), " &
"198 (BC_1, A(25), input, X), " &
"199 (BC_2, A(25), output3, X, 200, 0, Z), " &
num cell port function safe cell daval rsll
"200 (BC_2, *, control, 0), " & -- a[27:24]
"201 (BC_1, A(26), input, X), " &
"202 (BC_2, A(26), output3, X, 200, 0, Z), " &
"203 (BC_1, A(27), input, X), " &
"204 (BC_2, A(27), output3, X, 200, 0, Z), " &
"205 (BC_1, A(28), input, X), " &
"206 (BC_2, A(28), output3, X, 209, 0, Z), " &
"207 (BC_1, A(29), input, X), " &
"208 (BC_2, A(29), output3, X, 209, 0, Z), " &
"209 (BC_2, *, control, 0), " & -- a[31:28]
"210 (BC_1, A(30), input, X), " &
"211 (BC_2, A(30), output3, X, 209, 0, Z), " &
"212 (BC_1, A(31), input, X), " &
"213 (BC_2, A(31), output3, X, 209, 0, Z) ";
end MC68060;

```

9

9.2 DEBUG PIPE CONTROL MODE

A debug pipe control mode is implemented on the MC68060 to allow special chip functions to be accomplished. These functions are useful during system level hardware development and operating system debug. Access to the debug pipe control mode is achieved by negating the JTAG signal. When in the debug pipe control mode, the regular JTAG interface is used by the debug pipe control mode, and is therefore not available.

The debug pipe control mode uses the resulting serial interface to load commands that allow various operations on the processor to occur. Some of the operations are: halt the central processing unit (CPU), restart the CPU, insert select commands into the primary pipeline, disable select processor configurations, force all outputs to high-impedance state, release all outputs from high-impedance state, and generate an emulator interrupt.

The advantage of using the debug pipe control mode is that the processor is allowed to operate normally and at its normal frequency. The only difference is that the processor no longer has the regular JTAG interface. This should not be a problem since the regular JTAG interface is not used during normal processor operations.

9.2.1 Debug Command Interface

Figure 9-10 illustrates the debug command interface and Table 9-4 outlines the pins needed by the debug command interface. The debug command interface consists of a five-bit shift register and a five-bit parallel register, with each register operating independently. To activate the debug command interface, \overline{JTAG} must be driven negated. This allows the debug command interface to take over the regular JTAG interface and remap \overline{JTAG} pin functions. The resulting interface is fully synchronous to the CLK input.

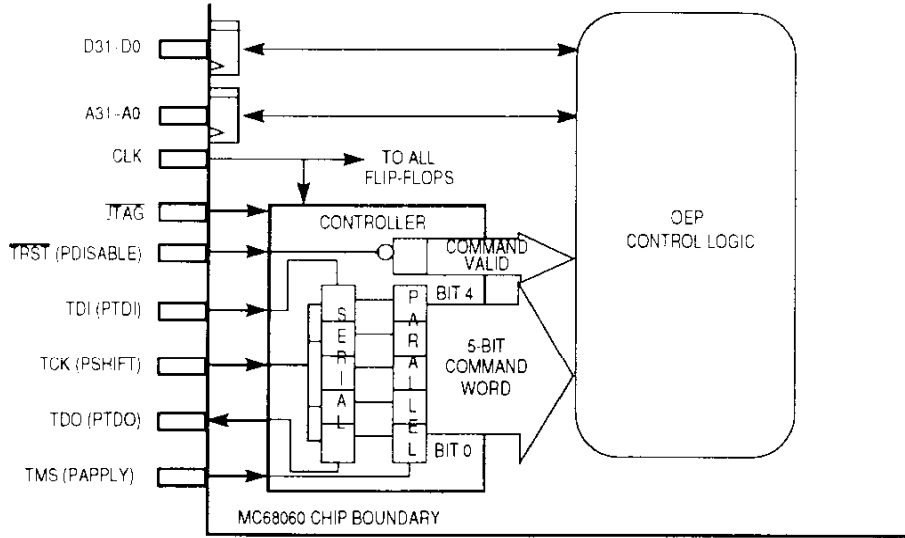

Figure 9-10. Debug Command Interface Schematic

Table 9-4. Debug Command Interface Pins

Pin Name	Alias	Description
TCK	PSHIFT	Serial Shift Enable
TMS	PAPPLY	Command Apply Enable
TDI	PTDI	Serial Command Data In
TRST	PDISABLE	Debug Command Disable
TDO	PTDO	Serial Command Data Out
JTAG	\overline{JTAG}	JTAG or Debug Select
CLK	CLK	Clock

The commands enter the debug command interface through the PTDI serial input signal into the five-bit shift register. The shift register is controlled by the PSHIFT input. The PSHIFT signal determines which rising CLK edge contains valid data on the PTDI input. When asserted the PSHIFT input causes data from the PTDI input to be latched and causes internal data bits already in the shift register to be passed on to the next shift register bit. Serial data eventually shifts out through the PTDO output. PTDO can be used as a status output and can be used to verify that the shift register is operating properly. Do not assert both PAPPLY and PSHIFT on the same CLK edge as this is interpreted as a "no operation".

IEEE 1149.1 Test (JTAG) and Debug Pipe Control Modes

Operating independently of the 5-bit shift register, the 6-bit parallel register is the command register used by the operand execution pipeline (OEP) control logic to control processor operations. The sixth bit of the parallel register is connected to the PDISABLE input and bypasses the 5-bit shift register. PDISABLE should normally be driven negated at all times to indicate that the command register is active. The other five bits of the parallel register are each connected to a corresponding bit in the shift register. The PAPPLY input controls the parallel register. When PAPPLY is asserted, the PDISABLE and shift register data are latched into the parallel register, and the command is then transmitted to the OEP control logic. Do not assert both PAPPLY and PSHIFT on the same rising CLK edge as this is interpreted as a "no operation". Do not assert PAPPLY more frequently than once every other rising CLK edge. Although most commands are five bits in length, it is not necessary to shift in all five bits for the "generate an emulator interrupt" command. For that command, only three bits need to be shifted in. Figure 9-11 shows a sample interface timing diagram.

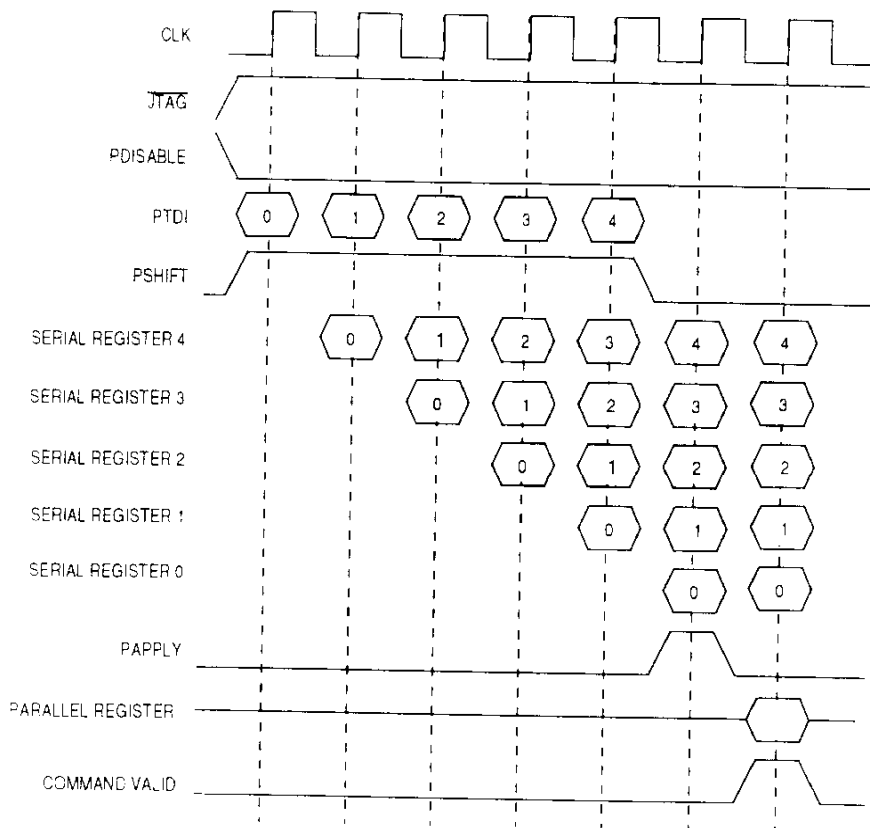

Figure 9-11. Interface Timing



9.2.2 Debug Pipe Control Mode Commands

The following capabilities are provided by the debug pipe control mode:

- Halt and restart processor execution
- Forcing the processor into an emulator mode
- From a halted processor state, the following additional capabilities are provided:
 - Setting and resetting a non-pipelined execution mode in the processor
 - Override disable processor configuration features (instruction cache, data cache, address translation caches (ATCs), write buffer, branch cache, floating-point unit (FPU), superscalar dispatch)
 - Forcing insertion of cache and ATC control operations into the processor pipeline for execution (CINV all for instruction cache and data cache, CPUSH all for instruction cache and data cache, and PFLUSH all for ATCs)
 - Forcing all processor outputs into and out of a high-impedance state and disable all inputs
 - Setting and resetting modes that convert trace exceptions and breakpoint instructions into emulator mode entry

Table 9-5 provides a brief summary of the command functions that are made available through the debug pipe control mode. Most of the commands can only be issued only when the processor is halted.

Table 9-5. Command Summary

Command	Command Operation
\$00	No operation
\$01	Restart the processor This command restarts the processor after it had been halted by the execution of a HALT instruction (opcode = \$4AC8), or receipt of the \$02 (Halt the processor) command. This command must be issued only when the processor is halted.
\$02	Halt the processor This command forces the processor to gracefully halt. The processor samples for halts once per instruction and if this command is present, the processor halts execution. The halted state is reflected in the PST encoding (PST = 11100).
\$03	Enable the PULSE instruction to toggle non-pipelined mode This command enables the PULSE instruction (opcode = \$4acc) to toggle the processor between the non-pipelined mode (allowing single-pipe dispatches) and normal pipeline mode. The PULSE instruction must be followed by a NOP to ensure proper operation. Refer to command \$07 for details of non-pipelined mode, single-pipe dispatch operation. The \$04 command negates the effect of this command. This command must be issued only when the processor is halted.
\$04	Reset all non-pipelined modes This command forces the processor to normal pipeline operation and negates the effect of the \$03, \$06, and \$07 commands. The \$04 command negates the effect of this command. This command must be issued only when the processor is halted.
\$05	Reserved
\$06	Enable non-pipelined mode (allowing superscalar dispatches) This command forces the processor into a non-pipelined mode of operation, while allowing superscalar dispatches (if PCR0 = 1). After an instruction pair is dispatched into the primary and secondary OEPs, execution of the subsequent instructions is delayed until the original instruction(s) complete execution and the pipeline is synchronized. The synchronization requires the processor to be in a quiescent state with all pending memory cycles complete. This implies all write buffers (push and store) are empty. The \$04 command negates the effect of this command. This command must be issued only when the processor is halted.
\$07	Enable non-pipelined mode (allowing single-pipe dispatches) This command forces the processor into a non-pipelined mode of operation, while allowing instruction dispatches into the primary OEP only. After an instruction has been dispatched into the primary OEP, execution of the subsequent instructions is delayed until the original instruction complete execution and the pipeline is synchronized. The synchronization requires the processor to be in a quiescent state with all pending memory cycles complete. This implies all write buffers (push and store) are empty. The \$04 command negates the effect of this command. This command must be issued only when the processor is halted.
\$08	Perform CINVA IC operation This command causes a CINVAIC instruction to be inserted into the primary OEP. This command must be received while the processor is halted.
\$09	Perform CINVA DC operation This command causes a CINVA DC instruction to be inserted into the primary OEP. This command must be received while the processor is halted.
\$0A	Perform CPUSHA IC,DC operation This command causes a CPUSHA IC,DC instruction to be inserted into the primary OEP. This command must be issued only when the processor is halted.
\$0B	Perform CPUSHA DC operation This command causes a CPUSHA DC instruction to be inserted into the primary OEP. This command must be issued only when the processor is halted.
\$0C	Perform PFLUSHA operation This command causes a PFLUSHA instruction to be inserted into the primary OEP. This command must be received while the processor is halted.

Table 9-5. Command Summary (Continued)

Command	Command Operation
\$0D	Force all the processor outputs to high-impedance state This command causes the processor to three-state all output pins and ignore all input pins. This command does not apply to the debug command interface pins. This forces the processor into a state where an emulator can generate system bus cycles by driving the appropriate pins. This command must be issued only when the processor is halted.
\$0E	Release all the processor outputs from high-impedance state This command causes the processor to re-enable all output pins and begin sampling all the input pins. This command must be issued only when the processor is halted.
\$0F	Negate the effects of the Disable commands This command causes the processor to disable the effects of the commands from \$10 to \$17.
\$10	Disable instruction cache This command forces the processor to run with the instruction cache disabled. The \$0F command negates the effect of this command. This command must be issued only when the processor is halted.
\$11	Disable data cache This command forces the processor to run with the data cache disabled. The \$0F command negates the effect of this command. This command must be issued only when the processor is halted.
\$12	Disable instruction ATC This command forces the processor to run with the instruction ATC disabled. The \$0F command negates the effect of this command. This command must be issued only when the processor is halted.
\$13	Disable data ATC This command forces the processor to run with the data ATC disabled. The \$0F command negates the effect of this command. This command must be issued only when the processor is halted.
\$14	Disable write buffer This command forces the processor to run with the store buffers disabled. This command operation is equivalent to that provided by the cache control register (CACR) bit 29. The \$0F command negates the effect of this command. This command must be issued only when the processor is halted.
\$15	Disable branch cache This command forces the processor to run with the branch cache disabled. The \$0F command negates the effect of this command. This command must be issued only when the processor is halted.
\$16	Disable FPU This command forces the FPU-disabled operation. The \$0F command negates the effect of this command. This command must be issued only when the processor is halted.
\$17	Disable secondary OEP This command disables superscalar operation. The \$0F command negates the effect of this command. This command must be issued only when the processor is halted.
\$18	trace -> normal trace; bkpt -> normal breakpoint Both the trace and breakpoint exceptions operate normally. This command must be issued only when the processor is halted.
\$19	trace -> normal trace; bkpt -> bkpt with emulator mode entry The trace exception operates normally. A breakpoint exception operates using vector offset \$30, in addition, the processor enters the emulator mode. This command must be issued only when the processor is halted.
\$1A	trace -> normal trace with emulator mode entry; bkpt -> normal breakpoint The breakpoint exception operates normally. A trace exception operates normally; in addition, the processor enters the emulator mode. This command must be issued only when the processor is halted.
\$1B	trace -> normal trace with emulator mode entry; bkpt -> bkpt with emulator mode entry The trace exception operates normally. The breakpoint exception operates using vector offset \$30. In addition, when either of these exceptions are taken, the processor enters the emulator mode. This command must be issued only when the processor is halted.
\$1C-\$1F	Generate an emulator interrupt Take an emulator interrupt exception.

IEEE 1149.1 Test (JTAG) and Debug Pipe Control Modes

There are two ways to halt the processor. The first method uses the debug pipe control mode command "halt the processor". This command causes the processor to gracefully halt instruction execution. When this command is received, the processor posts a pending halt condition and then waits for an interruptible point to be reached. Once the interruptible point is encountered, the processor halts instruction execution and signals the status with the PSTx signals.

The second method uses the HALT instruction. The HALT instruction is a 16-bit privileged instruction (\$4AC8 encoding) and is new with the MC68060 instruction set. When the processor executes this instruction, the pipeline is synchronized and then the processor enters the halted state. Once halted, the processor drives a unique PSTx output encoding.

The halt state is different than the stopped state since no interrupts are processed while in this mode. To enable the processor to exit the halted state and resume normal instruction execution, the "restart the processor" command is issued through the debug pipe control mode. When this command is received, the processor continues normal instruction execution by forcing an instruction fetch to the next sequential instruction address contained in the program counter (PC). Using this approach, any commands that may have been executed while halted (like patching memory and clearing the instruction cache) will be correctly handled by the processor when restarting. For instance, if the HALT instruction was used to place the processor into the halted state, instruction execution resumes at the instruction following the HALT instruction.

The commands \$06 and \$07 can be used to force nonpipelined operation. When operating in nonpipelined execution mode, the processor's OEP performs a single dispatch (of an instruction or instruction pair) and immediately enters a pipeline hold state that prevents subsequent dispatches. After the instruction/instruction pair has completed execution of all OEP pipeline stages, the hold state is reset to release another single dispatch. To allow toggling between normal operation and the nonpipelined, single-pipe operation, a new MC68060 instruction, the PULSE instruction, can be used by issuing command \$03.

The PULSE instruction is a 16-bit user mode instruction that uses the \$4ACC opcode. The PULSE instruction has been added to the instruction set primarily to provide a unique encoding of the PSTx outputs for external triggering purposes. Additionally, with command \$03, it is used to allow the capability to toggle in and out of nonpipelined operation mode. When the PULSE instruction is executed in user mode, the PSTx encoding \$04 will exist for one CLK period. When the PULSE instruction is executed in supervisor mode, the PSTx encoding of \$14 will exist for one CLK period.

When using the PULSE instruction to toggle in and out of nonpipelined mode, a NOP instruction must follow the PULSE instruction to ensure proper operation. All nonpipelined modes of operation are disabled through the "reset all nonpipelined modes" command \$04.

Commands \$08 to \$0C are used to insert instructions into the primary OEP. These instructions are executed immediately. Accordingly, any number of commands can be shifted into the processor while halted. The execution time of the instruction is equal to the normal execution time of the instruction plus three CLK periods, where the first cycle corresponds to the cycle when "command valid" is asserted. It is the responsibility of the external logic

inserting the commands to guarantee that there is sufficient time between commands to allow for proper operation.

Commands \$0D three-states all outputs and causes all inputs to be ignored. Command \$0E allows outputs to be driven and inputs to be sampled.

Commands \$10–\$17 force specific processor features to be disabled. Command \$0F negates the effects of all the commands between \$10 and \$17. These commands override the configuration as defined by the CACR, PCR, or TCR. Note that these instructions affecting processor configuration do not affect the operation of the MOVEC instructions which affect the CACR, PCR, or TCR. The MOVEC instruction to these registers operates normally, but the enabling of a specific feature is overridden if the corresponding debug function has been executed. Any MOVEC reading contents of the CACR, PCR, or TCR will return the value contained in the register and is independent of any debug commands which may have been executed.

Commands \$18–\$1B configure whether or not the trace and breakpoint exceptions force a processor entry into emulator mode.

Commands \$1C–\$1F generate an emulator interrupt exception.

9.2.3 Emulator Mode

The MC68060 implements a mode of operation that provides an outside control function (i.e., emulator) controllability and visibility mechanisms to direct MC68060 processor operations.

When the processor is in the emulator mode, the branch cache is not used. Instructions executed when the MC68060 is in emulator mode generate address space and bus transfer cycle attributes as an alternate logical function code space access with no address translation:

- No address translation
- No cache access
- TT1, TT0 = 2 {Alternate Logical Function Code Access}
- TM2–TT0 = 5 (operand references) or 6 (instruction references) {Logical Function Code 5 or 6}.

Entry into emulator mode can be accomplished via one of four methods:

1. A “generate emulator interrupt” command can be initiated through the debug pipe control mode. If this command is received by the MC68060, the processor waits for an interruptible point in the instruction stream, and then generates an emulator interrupt exception. A four-word exception stack frame (in alternate address space) is created, with the PC value equal to the next PC and the exception type/vector offset equal to \$30. The vector pointed to by VBR + \$30 defines the exception handler entry point, within the alternate address space (TT = 2, TM = 6).

IEEE 1149.1 Test (JTAG) and Debug Pipe Control Modes

2. After \overline{RSTI} is negated, the processor counts 16 CLKs before actually beginning the reset exception processing. The “generate emulator interrupt” command must be received through the debug pipe control mode within that 16-CLK window. The reset exception is processed normally, but the fetch of the initial stack pointer and initial PC is mapped to the alternate address space. Instruction execution begins in emulator mode. The reset exception vector pointed to by $VBR + \$04$ defines the entry point within the alternate address space.
3. If a breakpoint entry into emulator mode is enabled via the debug pipe control mode, the execution of a BKPT instruction generates an entry into emulator mode. For this case, the processor creates a four-word stack frame (in alternate address space) with the PC equal to the PC of the BKPT instruction and the vector offset equal to $\$30$. $VBR + \$30$ defines the entry point within the alternate address space.
4. If a trace entry into emulator mode is enabled via the debug pipe control mode, all trace exceptions cause an entry into the emulator mode. For this case, the processor creates the normal six-word trace exception stack frame (in alternate address space), with PC equal to the next PC, address equal to the last PC, and vector offset equal to $\$24$. The trace exception vector pointed to by $VBR + \$24$ defines the entry point within the alternate address space.

Exit from emulator mode is performed via the execution of an RTE instruction. Note that an RTE executed from emulator mode assumes that the stack is in the alternate address space. Other properties of the processor while executing in the emulator mode are as follows:

- MOVES instructions operate normally, using standard address translation/cache access for these instructions. The \overline{MDIS} and \overline{CDIS} input pins can be used to disable address translation and/or cache access on these instructions.
- TAS, CAS, and MOVE16 instructions must not be executed in emulator mode—results of these instructions executed in emulator mode are unpredictable (undefined).
- All interrupts are ignored while the MC68060 is in emulator mode.

If memory does not respond to the alternate function code space, it is the responsibility of the emulator to capture and save the stack frame information for its own use. The emulator is also responsible for supplying the saved stack frame information in response to the reads initiated by an RTE instruction (word read for SR, long-word read for PC, word read for format/vector). A unique PSTx encoding of $\$08$ is used to identify emulator mode exception processing.

The emulator interrupt exception is treated like other interrupts by the MC68060 processor and is sampled for at the completion of execution of an instruction. Once an interruptible point is encountered and the exception initiated, the processor pushes a normal exception stack frame (storing SR, PC, and format/vector and decrementing the supervisor stack pointer) by performing two long word writes. This is performed with emulator mode addressing—alternate function code space.

The emulator interrupt exception priority falls below trace and above regular interrupts in the MC68060 exception priority list. Its exception vector number is 12 (vector offset = $\$30$), its stack frame is four-word (format = 0), and it stores the PC of the next instruction (like other

interrupts). The 32-bit instruction address of the first instruction of the emulator interrupt exception handler is derived as with other exceptions—the memory contents of address VBR + exception offset (\$30).

The emulator mode entry from the breakpoint exception shares the same vector table entry (VBR + \$30) as the emulator interrupt exception. However, the emulator mode entry from the breakpoint exception requires that the exception handler increment the stacked PC by two to point to the instruction following the breakpoint instruction. On the other hand, the emulator interrupt stack's PC already points to the next instruction.

9.3 SWITCHING BETWEEN JTAG AND DEBUG PIPE CONTROL MODES OF OPERATION

Since JTAG and the debug pipe control modes share the same set of pins, only one mode can be used at a time. Normally, the JTAG mode is used only during product testing, and the debug pipe control mode is used by the end user in conjunction with an in-circuit emulator. For this use, the board manufacturer normally designs in whatever JTAG functionality is required without regard to whether the board will eventually be used in the debug pipe control mode or not. The responsibility of allowing the processor to operate under the debug pipe control mode lies with the emulator vendor. The emulator vendor needs to ensure that the socket built to carry the processor has the target system's JTAG pins isolated from the processor to allow full control of these pins. Hence, under normal circumstances, dynamic switching between JTAG and debug pipe control modes is unnecessary.

However, for systems that need to switch between these modes can do so by following some guidelines. These guidelines are illustrated in Figure 9-12 and Figure 9-13. These figures illustrate how to transition between the JTAG mode and the debug pipe control mode.

IEEE 1149.1 Test (JTAG) and Debug Pipe Control Modes

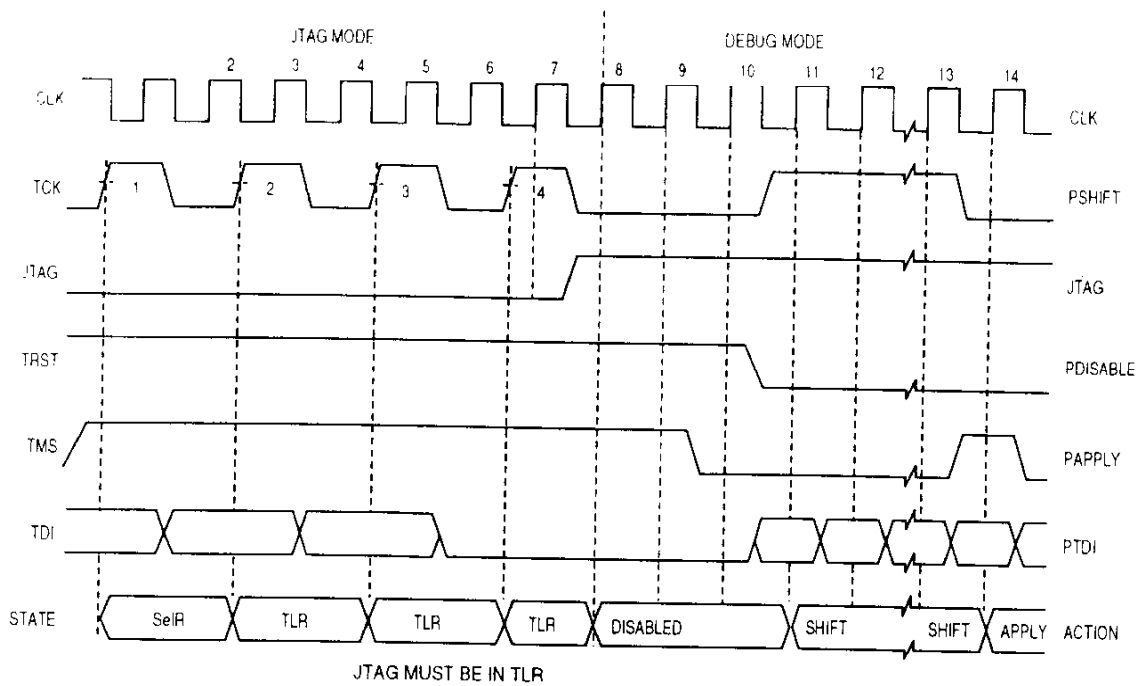

NOTES:

1. Clock is shown at 2x TCK here for illustration. Any relationship may exist but 3 full rising edges of CLK should occur after \overline{JTAG} goes high and before PSHIFT or PDISABLE change.
2. When \overline{JTAG} goes high, the MC68060 goes from "functional with JTAG" to "functional with DEBUG". When going to DEBUG modes the JTAG package pins remap to:

\overline{TRST} → PDISABLE	} ALL "P" signals internally negated when \overline{JTAG} = low.
TDI → PTDI	
TMS → PAPPLY	
TCK → PSHIFT	

3. Hold TRST - H across boundary to prevent PAPPLY.
4. Hold TMS - H across boundary to keep JTAG in TLR.
5. After the boundary, PAPPLY must be negated before PDISABLE negates.

Figure 9-12. Transition from JTAG to Debug Mode Timing Diagram

IEEE 1149.1 Test (JTAG) and Debug Pipe Control Modes

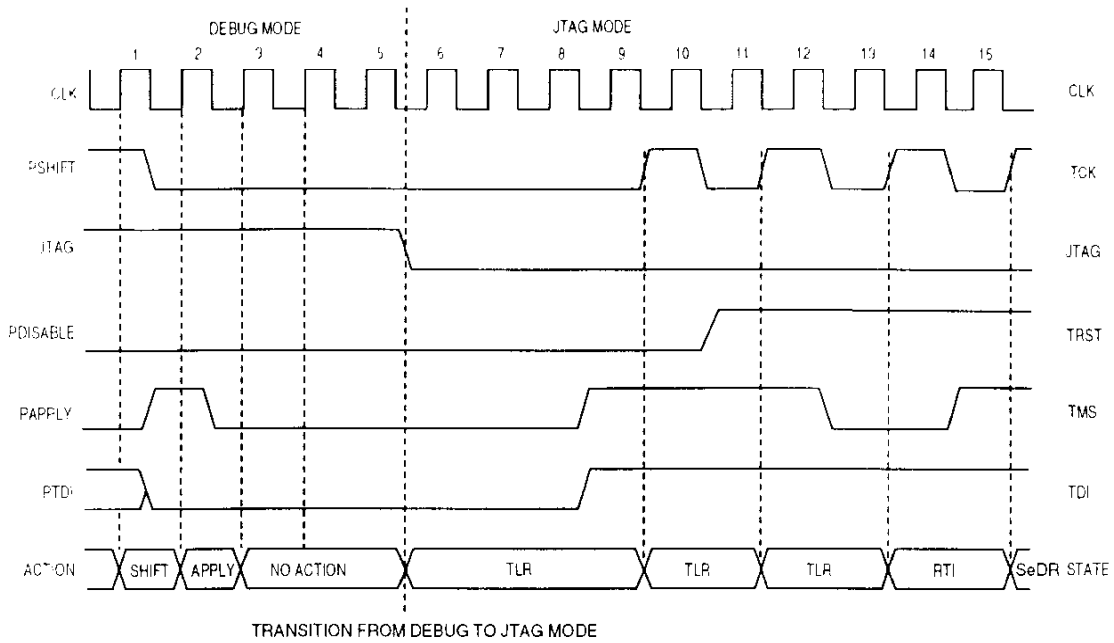

- NOTES:
1. Clock is shown at 2x TCK here for illustration.
 2. Hold PSHIFT = L and PAPPLY = L across boundary to prevent debug command.
 3. Hold PDISABLE = L across boundary to asynchronously set to TLR state.
 4. Establish PTDI = H and TMS = H before starting TCK.
 5. Negate PDISABLE after starting TCK.

Figure 9-13. Transition from Debug to JTAG Mode Timing Diagram

SECTION 10 INSTRUCTION EXECUTION TIMING

This section details the MC68060 instruction execution times in terms of processor clock cycles and the superscalar architecture. The number of operand cycles for each instruction is also included, enclosed in parentheses following the number of clock cycles. Timing entries are presented as:

$$C(r/w)$$

where:

- C = The number of processor clock cycles, including all applicable operand fetches and stores, plus all internal CPU cycles required to complete the instruction execution.
- r/w = The number of operand reads (r) and writes (w). A read-modify-write cycle is denoted as (1/1).

10.1 SUPERSCALAR OPERAND EXECUTION PIPELINES

The superscalar architecture of the MC68060 processor consists of three structures within the operand execution pipeline (OEP). The components include a primary OEP (pOEP), a secondary OEP (sOEP) plus a monolithic register file containing the general-purpose registers, Dn and An. As instructions are gated out of the instruction fetch pipeline's instruction buffer, consecutive operation words (if available) are loaded into the pOEP and sOEP. A superscalar instruction dispatch algorithm must then determine if the instruction-pair may continue its OEP execution simultaneously.

Each OEP consists of two compute engines: an adder structure for calculating operand virtual addresses (the address generation unit (AGU)) and an integer execute engine for performing instruction operations (the integer execute engine (IEE)).

Instruction Execution Timing

Each compute engine has resources associated with its respective function. A generalized model of the resources required for instruction execution can be stated as:

$$\text{Instruction Resources} = f(\text{Base, Index, A, B, Address_result, Execute_result})$$

where:

Base	=	Base address register for the AGU
Index	=	Index register for the AGU
A	=	Source operand required by the "A" side of the arithmetic/logic unit within the integer execute engine
B	=	Source operand required by the "B" side of the arithmetic/logic unit within the integer execute engine
Address_result	=	Result operand produced by the address generation unit
Execute_result	=	Result operand produced by the integer execute engine

In the MC68060 design, the dispatch algorithm is implemented by assigning a 5-bit "name" to each resource. The name is then used to identify the exact resource required for each instruction's execution. The resource name may identify one of the sixteen general-purpose machine registers (Rn) or a non-register resource (e.g., memory operand, immediate operand, etc.).

The dispatch algorithm operates within the first stage of the operand execution pipeline. The results of the resource examination must be completed within this first stage to transition the appropriate instruction(s) into the subsequent stages of the OEPs. In particular, the dispatch algorithm determines if resource conflicts exist between the pOEP and sOEP.

By definition of the MC68060 architecture, there are no conflicts possible on non-register resources. This means the dispatch algorithm must detect any register resource conflicts between the pOEP and sOEP. The sOEP resource requirements are validated through a series of six tests. If all the tests are successful, the sOEP instruction is dispatched simultaneously with the pOEP instruction into the second stage of the pipeline. If any test fails, the dispatching of the sOEP instruction is inhibited.

10.1.1 Dispatch Test 1: sOEP Opword and Required Extension Words Are Valid

Whenever instructions are loaded into the OEP, the instruction buffer attempts to load a 16-bit operation word and 32-bits of extension words into both the pOEP and sOEP. This test validates that the operation word and any extension words required by the sOEP instruction are present. If the required opword and extensions are valid, the subsequent tests may be performed. In the event that any of the required instruction words are not valid, the instruction in the pOEP is dispatched immediately rather than delay execution waiting for instruction words for the sOEP.

10.1.2 Dispatch Test 2: Instruction Classification

The instruction set of the M68000 family can be broadly separated into two groups: standard and non-standard instructions. Standard instructions represent the majority of the instruction set and the basic control structure for the OEP supports these operations without any instruction-specific control states. Conversely, the non-standard instructions represent more complex operations and require additional hardware to control their execution within the

OEP. In many cases, a non-standard instruction requires multiple cycles to execute and the operation is decomposed into a series of “standard” cycles.

The MC68060 definition of a standard instruction is:

- The instruction requires a maximum of one set of extension words.
- The instruction makes a maximum of one memory access.
- The resources required by the instruction are completely specified by the operation word.

The standard instruction group is subdivided into two classes:

- | | |
|-------------|---|
| pOEP sOEP | This class identifies those standard instructions which may be executed in either the primary or secondary OEP. This group represents all standard single-cycle instructions. |
| pOEP-only | This class of standard instructions may be executed in the primary OEP only. This class includes all multi-cycle standard instructions. |

The non-standard instruction group is subdivided into three classes:

- | | |
|----------------------|---|
| pOEP-until-last | Many of the non-standard instructions represent a combination of multiple “standard” operations. As an example, consider the memory-to-memory MOVE instruction. This instruction is decomposed into two standard operations: first, a standard read cycle followed by a standard write cycle. This class allows a standard single-cycle instruction to be dispatched from the sOEP during the last cycle of its pOEP execution. |
| pOEP-only | This class of non-standard instructions may only be executed in the primary OEP. |
| pOEP-but-allows-sOEP | This class of non-standard instructions requires that the operation be performed in the primary OEP, but allows standard instructions of the pOEP sOEP class to be dispatched to the secondary OEP. |

Given these instruction classifications, consider Table 10-1 which defines Test 2 of the superscalar dispatch algorithm of the OEP:

Instruction Execution Timing

Table 10-1. Superscalar OEP Dispatch Test Algorithm

Contents of pOEP	Contents of sOEP	Dispatch Algorithm
pOEP sOEP	pOEP sOEP	Test 2 is successful
pOEP sOEP	pOEP-only	Test 2 fails
pOEP sOEP	pOEP-until-last	Test 2 fails
pOEP sOEP	pOEP-but-allows-sOEP	Test 2 fails
—	—	—
pOEP-only	pOEP sOEP	Test 2 fails
pOEP-only	pOEP-only	Test 2 fails
pOEP-only	pOEP-until-last	Test 2 fails
pOEP-only	pOEP-but-allows-sOEP	Test 2 fails
—	—	—
pOEP-until-last	pOEP sOEP	Test 2 is successful
pOEP-until-last	pOEP-only	Test 2 fails
pOEP-until-last	pOEP-until-last	Test 2 fails
pOEP-until-last	pOEP-but-allows-sOEP	Test 2 fails
—	—	—
pOEP-but allows-sOEP	pOEP sOEP	Test 2 is successful
pOEP-but allows-sOEP	pOEP-only	Test 2 fails
pOEP-but allows-sOEP	pOEP-until-last	Test 2 fails
pOEP-but allows-sOEP	pOEP-but-allows-sOEP	Test 2 fails

Table 10-2, Table 10-3, and Table 10-4 define the classification for the entire instruction set. The notation “-(Ax)+” indicates $\langle ea \rangle = \{(Ax), (Ax)+, -(Ax)\}$.

Table 10-2. MC68060 Superscalar Classification of M680x0 Integer Instructions

Mnemonic	Instruction	Superscalar Classification
ABCD	Add Decimal with Extend	pOEP-only
ADD	Add	pOEP sOEP
ADDA	Add Address	pOEP sOEP
ADDI,Dx	Add Immediate	pOEP sOEP
ADDI,-(Ax)+	“	pOEP sOEP
Remaining ADDI	“	pOEP sOEP
ADDQ	Add Quick	pOEP-until-last
ADDX	Add Extended	pOEP sOEP
AND	AND Logical	pOEP-only
ANDI,Dx	AND Immediate	pOEP sOEP
ANDI,-(Ax)+	“	pOEP sOEP
Remaining ANDI	“	pOEP sOEP
ANDI to CCR	AND Immediate to Condition Codes	pOEP-until-last
ASL	Arithmetic Shift Left	pOEP-only
ASR	Arithmetic Shift Right	pOEP sOEP
Bcc	Branch Conditionally	pOEP sOEP
BCHG Dy,	Test a Bit and Change	pOEP-only ¹
BCHG #<imm>,	“	pOEP-only
BCLR Dy,	Test a Bit and Clear	pOEP-until-last
BCLR #<imm>,	“	pOEP-only
BFCHG	Test Bit Field and Change	pOEP-until-last
BFCLR	Test Bit Field and Clear	pOEP-only

Table 10-2. MC68060 Superscalar Classification of M680x0 Integer Instructions (Continued)

Mnemonic	Instruction	Superscalar Classification
BFEXTS	Extract Bit Field Signed	pOEP-only
BFEXTU	Extract Bit Field Unsigned	pOEP-only
BFFFO	Find First One in Bit Field	pOEP-only
BFINS	Insert Bit Field	pOEP-only
BFSET	Set Bit Field	pOEP-only
BFTST	Test Bit Field	pOEP-only
BKPT	Breakpoint	pOEP-only
BRA	Branch Always	pOEP-only
BSET Dy,	Test a Bit and Set	pOEP-only
BSET #<imm>,	"	pOEP-until-last
BSR	Branch to Subroutine	pOEP-only
BTST Dy,	Test a Bit	pOEP-only
BTST #<imm>,	"	pOEP-until-last
CAS	Compare and Swap with Operand	pOEP-only
CHK	Check Register Against Bounds	pOEP-only
CLR	Clear an Operand	pOEP sOEP
CMP	Compare	pOEP sOEP
CMPA	Compare Address	pOEP sOEP
CMPI,Dx	Compare Immediate	pOEP sOEP
CMPI,-(Ax)+	"	pOEP sOEP
Remaining CMPI	"	pOEP-until-last
CMPM	Compare Memory	pOEP-until-last
DBcc	Test Condition, Decrement and Branch	pOEP-only
DIVS.L	Signed Divide Long	pOEP-only
DIVS.W	Signed Divide Word	pOEP-only
DIVU.L	Unsigned Long Divide	pOEP-only
DIVU.W	Unsigned Divide Word	pOEP-only
EOR	Exclusive OR Logical	pOEP sOEP
EORI,Dx	Exclusive OR Immediate	pOEP sOEP
EORI,-(Ax)+	"	pOEP sOEP
Remaining EORI	"	pOEP-until-last
EORI to CCR	Exclusive OR Immediate to Condition Codes	pOEP-only
EXG	Exchange Registers	pOEP-only
EXT	Sign Extend	pOEP sOEP
EXTB.L	Sign Extend Byte to Long	pOEP sOEP
ILLEGAL	Take Illegal Instruction Trap	pOEP sOEP
JMP	Jump	pOEP-only
JSR	Jump to Subroutine	pOEP-only
LEA	Load Effective Address	pOEP sOEP
LINK	Link and Allocate	pOEP-until-last
LSL	Logical Shift Left	pOEP sOEP
LSR	Logical Shift Right	pOEP sOEP
MOVE,Rx	Move Data from Source to Destination	pOEP sOEP
MOVE Ry,	"	pOEP sOEP
MOVE <mem>y,<mem>x	"	pOEP-until-last
MOVE #<imm>,<mem>x	"	pOEP-until-last
MOVEA	Move Address	pOEP sOEP
MOVE from CCR	Move from Condition Codes	pOEP-only

Instruction Execution Timing

Table 10-2. MC68060 Superscalar Classification of M680x0 Integer Instructions (Continued)

Mnemonic	Instruction	Superscalar Classification
MOVE to CCR	Move to Condition Codes	pOEP sOEP
MOVE16	Move 16 Byte Block	pOEP-only
MOVEM	Move Multiple Registers	pOEP-only
MOVEQ	Move Quick	pOEP sOEP
MULS.L	Signed Multiply Long	pOEP-only
MULS.W	Signed Multiply Word	pOEP-only
MULU.L	Unsigned Multiply Long	pOEP-only
MULU.W	Unsigned Multiply Word	pOEP-only
NBCD	Negate Decimal with Extend	pOEP-only
NEG	Negate	pOEP sOEP
NEGX	Negate with Extend	pOEP-only
NOP	No Operation	pOEP-only
NOT	Logical Complement	pOEP sOEP
OR	Inclusive OR Logical	pOEP sOEP
ORI,Dx	Inclusive OR Immediate	pOEP sOEP
ORI,-(Ax)+	"	pOEP sOEP
Remaining ORI	"	pOEP-until-last
ORI to CCR	Inclusive OR Immediate to Condition Codes	pOEP-only
PACK	Pack BCD Digit	pOEP-only
PEA	Push Effective Address	pOEP-only
ROL	Rotate without Extend Left	pOEP sOEP
ROR	Rotate without Extend Right	pOEP sOEP
ROXL	Rotate with Extend Left	pOEP-only
ROXR	Rotate with Extend Right	pOEP-only
RTD	Return and Deallocate Parameters	pOEP-only
RTR	Return and Restore Condition Codes	pOEP-only
RTS	Return from Subroutine	pOEP-only
SBCD	Subtract Decimal with Extend	pOEP-only
Scc	Set According to Condition	pOEP-but-allows-sOEP
SUB	Subtract	pOEP sOEP
SUBA	Subtract Address	pOEP sOEP
SUBI,Dx	Subtract Immediate	pOEP sOEP
SUBI,-(Ax)+	"	pOEP sOEP
Remaining SUBI	"	pOEP-until-last
SUBQ	Subtract Quick	pOEP sOEP
SUBX	Subtract with Extend	pOEP-only
SWAP	Swap Register Halves	pOEP-only
TAS	Test and Set an Operand	pOEP-only
TRAP	Trap	pOEP sOEP
TRAPF	Trap on False	pOEP sOEP
remaining TRAPcc	Trap on Condition	pOEP-only
TRAPV	Trap on Overflow	pOEP-only
TST	Test an Operand	pOEP sOEP
UNLK	Unlink	pOEP-only
UNPK	Unpack BCD Digit	pOEP-only

¹ A Bcc instruction is pOEP-but-allows-sOEP if it is not predicted from the branch cache and the direction of the branch is forward or if the Bcc is predicted as a "not-taken" branch.

Table 10-3. Superscalar Classification of M680x0 Privileged Instructions

Mnemonic	Instruction	Superscalar Classification
ANDI to SR	AND Immediate to Status Register	pOEP-only
CINV	Invalidate Cache Lines	pOEP-only
CPUSH	Push and Invalidate Cache Lines	pOEP-only
EORI to SR	Exclusive OR Immediate to Status Register	pOEP-only
MOVE from SR	Move from Status Register	pOEP-only
MOVE to SR	Move to Status Register	pOEP-only
MOVE USP	Move User Stack Pointer	pOEP-only
MOVEC	Move Control Register	pOEP-only
MOVES	Move Address Space	pOEP-only
ORI to SR	Inclusive OR Immediate to Status Register	pOEP-only
PFLUSH	Flush ATC Entries	pOEP-only
PLPA	Load Physical Address	pOEP-only
RESET	Reset External Devices	pOEP-only
RTE	Return from Exception	pOEP-only
STOP	Load Status Register and Stop	pOEP-only

Table 10-4. Superscalar Classification of M680x0 Floating-Point Instructions

Mnemonic	Instruction	Superscalar Classification
FABS, FDABS, FSABS	Absolute Value	pOEP-but-allows-sOEP ¹
FADD, FDADD, FSADD	Add	pOEP-but-allows-sOEP ¹
FBcc	Branch Conditionally	pOEP-only
FCMP	Compare	pOEP-but-allows-sOEP ¹
FDIV, FDDIV, FSDIV, FSGLDIV	Divide	pOEP-but-allows-sOEP ¹
FINT, FINTRZ	Integer Part, Round-to-Zero	pOEP-but-allows-sOEP ¹
FMOVE, FDMOVE, FSMOVE	Move Floating-Point Data Register	pOEP-but-allows-sOEP ¹
FMOVE	Move System Control Register	pOEP-only
FMOVEM	Move Multiple Data Registers	pOEP-only
FMUL, FDMUL, FSMUL, FSGLMUL	Multiply	pOEP-but-allows-sOEP ¹
FNEG, FDNEG, FSNEG	Negate	pOEP-but-allows-sOEP ¹
FNOP	No Operation	pOEP-only
FSQRT	Square Root	pOEP-but-allows-sOEP ¹
FSUB, FDSUB, FSSUB	Subtract	pOEP-but-allows-sOEP ¹
FTST	Test Operand	pOEP-but-allows-sOEP ¹

¹ These floating-point instructions are pOEP-but-allows-sOEP except for the following:

- F<op>Dm,FPn
- F<op>&imm,FPn
- F<op>.x<mem>,FPn

which are classified as pOEP-only

The MC68060 superscalar architecture allows pairs of single-cycle standard operations to be simultaneously dispatched in the operand execution pipelines. Additionally, the design also permits a single-cycle standard instruction plus a conditional branch (Bcc) predicted by the branch cache to be dispatched in the OEP. Bcc instructions predicted as not taken allow another instruction to be executed in the sOEP. This also is true for forward Bcc instructions that are not predicted.

Instruction Execution Timing

Additionally, the use of instruction folding techniques allow one or two instructions to be simultaneously executed with a predicted taken Bcc (also for BRA and JMP instructions).

The floating-point pre-exception model of the MC68060 supports execution overlap between multi-cycle floating-point instructions and the integer execute engines. Once a multi-cycle floating-point instruction has started its execution, the primary and secondary OEPs may continue to dispatch and complete integer instructions in parallel with the floating-point instructions. The OEPs will stall only if another floating-point instruction is encountered before the first floating-point instruction has completed its execution. The floating-point instructions that permit this execution overlap are classified as pOEP-but-allows-sOEP in Table 10-4.

10.1.3 Dispatch Test 3: Allowable Effective Addressing Mode in the sOEP

To minimize the hardware structures required for the address generation unit within the secondary OEP, certain addressing modes are not allowed. The addressing modes not supported by the sOEP include: the address register indirect with index plus base displacement $\{(bd, An, Xi*SF)\}$ and all PC-relative modes $\{(d16, PC), (d8, PC, Xi*SF), (bd, PC, Xi*SF)\}$.

10.1.4 Dispatch Test 4: Allowable Operand Data Memory Reference

The MC68060 processor design features a shared operand data cache pipeline capable of supporting a single operand reference per machine cycle. This test validates that only a single operand data memory reference is present between the instruction-pair in the pOEP and sOEP.

10.1.5 Dispatch Test 5: No Register Conflicts on sOEP.AGU Resources

This test validates that the register resources of the sOEP.AGU (Base, Index) do not conflict with the results being generated by the instruction in the pOEP. The most significant bit of the resource name is asserted to indicate a register resource. Thus, this test can be stated as:

```

test5 = 1          /* set test5 as okay
if (sOEP.Base > 15)/* indicates a valid register
/* if the sOEP.Base equals the pOEP's Address_ or Execute_result, a conflict exists
    if ((sOEP.Base = pOEP.Address_result) || (sOEP.Base = pOEP.Execute_result))
        test5 = 0/* test5 has register conflict; test fails

if (sOEP.Index > 15)/* indicates a valid register

/* if the sOEP.Index equals the pOEP's Address_ or Execute_result, a conflict exists
    if ((sOEP.Index = pOEP.Address_result) || (sOEP.Index = pOEP.Execute_result))
        test5 = 0/* test5 has register conflict; test fails
    
```

As examples of failing sequences, consider the following instruction pairs:

```

add.l #<data>,a0Execute_result = a0
mov.l (a0),d0Base = a0

add.l d1,d0 Execute_result = d0
lea (a1),d1,a0Index = d0
    
```

If the first instruction of each pair is contained in the pOEP and the second in the sOEP, test 5 fails for both pairs. For the first example, the base resource required by the sOEP conflicts with the execute result generated by the pOEP instruction. In the second example, the index resource required by the sOEP conflicts with the execute result from the pOEP instruction.

10.1.6 Dispatch Test 6: No Register Conflicts on sOEP.IEE Resources

This test validates that the register resources of the sOEP.IEE (A, B) do not conflict with the execute result being generated by the instruction in the pOEP. Recall the most significant bit of the resource name is asserted to indicate a register resource. Thus, this test can be stated as:

```
test6 = 1          /* set test6 as okay
if (sOEP.A > 15) /* indicates a valid register
/* if the sOEP.A equals the pOEP's Execute_result, a conflict exists
    if ((sOEP.A = pOEP.Execute_result))
        test6 = 0/* test6 has register conflict
if (sOEP.B > 15) /* indicates a valid register
/* if the sOEP.B equals the pOEP's Execute_result, a conflict exists
    if ((sOEP.B = pOEP.Execute_result))
        test6 = 0/* test6 has register conflict
```

There are two very important exceptions to this rule involving the MOVE instruction:

1. If the primary OEP instruction is a simple “move long to register” (MOVE.L,Rx) and the destination register Rx is required as either the sOEP.A or sOEP.B input, the MC68060 bypasses the data as required and the test succeeds.
2. In the following sequence of instructions:

```
<op>.l, Dx
mov.l Dx, <mem>
```

the result of the pOEP instruction is needed as an input to the sOEP.IEE and the sOEP instruction is a move instruction. The destination operand for the memory write is sourced directly from the pOEP execute result and the test succeeds.

10

Consider the following examples:

```
asl.l &k, d0      Execute_result = d0
add.l d0, d1      A = d0
add.l <ea>, d1    Execute_result = d1
sub.l d0, d1      B = d1
mov.l <ea>, d0    Execute_result = d0
add.l d0, d1      A = d0
```

For all the examples, let the first instruction be loaded into the primary OEP and the second loaded into the secondary OEP.

In the first and second examples, the result of the pOEP instruction is required as an input to the sOEP.IEE. Since the pOEP instruction is not a simple MOVE operation, the test fails in each case.

In the third example, the result of the pOEP operation is needed as an input to the sOEP.IEE, but since the pOEP is executing the register-load MOVE instruction, the desti-

Instruction Execution Timing

nation operand can be routed to the sOEP before the actual “execution” of the pOEP instruction. The test succeeds in this example.

10.2 TIMING ASSUMPTIONS

For the timing data presented, the following assumptions are made:

1. The data presents the execution times for individual instructions and makes no assumptions concerning the ability of the MC68060 to dispatch multiple instructions in a given machine cycle. For sequences where instruction-pairs are dispatched, the execution time of the two instructions is defined by the execution time of the instruction in the pOEP.
2. The OEP is loaded with the opword and all required extension words at the beginning of each instruction execution. This implies that the OEP spends no time waiting for the instruction fetch pipeline (IFP) to supply opwords and/or extensions.
3. The OEP does not experience any sequence-related pipeline stalls. The most common example of this type of stall is a “change/use” register stall. This type of stall results from a register being modified by an instruction and a subsequent instruction generating an address using the previously modified register. The second instruction must stall in the OEP until the register is actually updated by the previous instruction. For example:

```

muls.l #<data>,d0
mov.l (a0,d0.l*4),d1

```

In this sequence, the second instruction is held for 2 clock cycles stalling for the first instruction to complete the update of the d0 register. If consecutive instructions load a register and then use that register as the base for an address calculation (An), a 2-clock-cycle wait may be incurred. This represents the maximum change/use penalty for a base register. The maximum change/use penalty for an index register (Xi) is 3 clock cycles (for Xi.l*2, Xi.l*8, and Xi.w). The change/use penalty for an index register if Xi.l*1 or Xi.l*4 is 2 clock cycles.

Certain instructions have been optimized to ensure no change/use stall occurs on subsequent instructions. The destination register of the following instructions is available for subsequent instructions:

```

lax
mov.l &imm, Rn
mvq
r.l Dn,
any op(An)+
any op-(An)

```

as a base register for address calculation with no stall, or as an index register for address calculation with no stall, if Xi.l*{1,4}. If the index register used is Xi.l*2, Xi.l*8, or Xi.w, then the previously described 3 cycle stall occurs.

The MC68060 provides another change/use optimization for a commonly encountered construct—when an address register is loaded from memory and then used in an operand address calculation, the OEP experiences a one cycle stall.

new element, An
 operation using An>

4. The OEP is able to complete all memory accesses without any stall conditions due to ATC or cache misses and/or operand data cache bank busy. This means all operand data memory references produce address translation cache hits, are mapped to cachable pages, and produce hits in the operand data cache. Additionally, branch instructions are assumed to produce an instruction cache hit for the target address instruction fetch.

The occurrence of any cache miss will add a specific number of cycles to the base execution time of an instruction (see **10.3 Cache and atc Performance Degradation Times** and **10.4 Effective Address Calculation Times**).

For instructions which generate external bus cycles as part of their execution (e.g., MOVE16, CPUSH), a 2-1-1-1 memory system is assumed.

5. All data accesses are assumed to be aligned on the same byte boundary as the operand size:
 - 16-bit operands aligned on 0-modulo-2 addresses
 - 32-bit operands aligned on 0-modulo-4 addresses
 - 64-bit operands aligned on 0-modulo-8 addresses
 - 96-bit operands aligned on 0-modulo-4 addresses

If the operand alignment fails these suggested guidelines, the reference is termed a misaligned access. The processor is required to make multiple accesses to obtain any misaligned operand. For copyback or writethrough pages, one processor clock cycle must be added to the instruction execution time for a misaligned read reference. Two clock cycles must be added for a misaligned write or read-modify-write.

6. Certain instructions perform a pipeline synchronization prior to their actual execution. For these opcodes, the instruction enters the pOEP and then waits until the following conditions are met:
 - The instruction cache is in a quiescent state with all outstanding cache misses completed.
 - The data cache is in a quiescent state with all outstanding cache misses completed.
 - The push and write buffers are empty.
 - The execution of all previous instructions has completed.

Once all these conditions are satisfied, the instruction begins its actual execution.

For the instruction timings listed in the timing data, the following assumptions are made for these pipeline synchronization instructions:

- The instruction cache is not processing any cache misses.
- The data cache is not processing any cache misses.
- The push and write buffers are empty.
- The OEP has dispatched an instruction or instruction-pair on the previous cycle.

Instruction Execution Timing

The following instructions perform this pipeline synchronization:

```
andi_to_sr
bkpt
cas
cinv
cpush
eori_to_sr
halt
lpstop
move_to_sr
movec
nop
ori_to_sr
pflush
plpa
reset
rte
stop
tas
```

7. Certain instructions have a variable execution time based on input operands, cache state, etc. For these instructions, the execution time listed represents the maximum value. These times are listed as: $\leq k(r/w)$ where k is the maximum time.

10.3 CACHE AND ATC PERFORMANCE DEGRADATION TIMES

This section defines degradation times to MC68060 processor performance for cache and ATC miss conditions (as detailed in **10.2 Timing Assumptions**, the performance numbers in **10.1.5 Dispatch Test 5: No Register Conflicts on sOEP.AGU Resources** and **10.1.6 Dispatch Test 6: No Register Conflicts on sOEP.IEE Resources** assume internal cache hits for all memory accesses). If a cache miss is encountered, the appropriate delay times defined in this section are to be used with the instruction times defined in **10.1.5 Dispatch Test 5: No Register Conflicts on sOEP.AGU Resources** and **10.1.6 Dispatch Test 6: No Register Conflicts on sOEP.IEE Resources** to determine MC68060 execution time.

10.3.1 Instruction ATC Miss

Assumptions:

- A single, "C-index" level, normal table search (the only U-bit update possible is for the page descriptor itself).
- Given a memory response time of "w-x-y-z" to the bus interface of the MC68060.

Instruction ATC Miss = $10+3*w(3/0)$, if U-bit of descriptor is already set.

Instruction ATC Miss = $18+5*w(4/1)$, if U-bit of descriptor must be set by the MC68060.

10.3.2 Data ATC Miss

Assumptions:

- A single, "C-index" level, normal table search (the only U-bit or M-bit update possible is for the page descriptor itself).
- Given a memory response time of "w-x-y-z" to the bus interface of the MC68060.

Data ATC Miss = $8+3*w(3/0)$, if U-bit and M-bit of descriptor are in the proper state.

Data ATC Miss = $14+4*w(3/1)$, if M-bit only, or U-bit and M-bit of descriptor must be set by the MC68060.

Data ATC Miss = $16+5*w(4/1)$, if U-bit only of descriptor must be set by the MC68060.

10.3.3 Instruction Cache Miss

Assumptions:

- The following degradation time assumes the MC68060 instruction buffer is empty and the instruction cache miss memory access time is fully exposed. This is an estimated degradation using a conservative assumption.

Note that the MC68060 instruction fetch pipeline prefetches continually, loading instructions into the instruction buffer, which decouples the instruction fetch pipeline from the operand execution pipeline. As a result, instruction cache miss memory access times for most operations will be partially or completely hidden by the instruction buffer, contributing minimal degradation to actual execution time.

- The following degradation estimate assumes an instruction fetch flow of sequential operations, the cache miss line is entered sequentially and contains no branches/jumps.
- Given a memory response time of "w-x-y-z" to the bus interface of the MC68060.

10

Instruction Cache Miss (Line Fill) = $w+x+y+z$

10.3.4 Data Cache Miss

Assumptions:

- Given a memory response time of "w-x-y-z" to the bus interface of the MC68060.

If copyback mode:

Data Cache Miss (Line Fill) = $2+w$ {+, if during $x+y+z$ a memory data operand reference is made by a subsequent instruction, an operand execution pipeline stall will take place until the entire line is written into the data cache during $x+y+z$ }

If noncacheable mode (operand read):

Data Cache Miss = $2+w$

If noncacheable mode (operand write) and precise mode or write buffer disabled:

Data Cache Miss = $3+w$

10.4 EFFECTIVE ADDRESS CALCULATION TIMES

Table 10-5 shows the number of clock cycles required to compute an instruction's effective address. The MC68060 address generation hardware supports the calculation of most effective addresses within the structure of the operand execution pipeline with no additional cycles required. The number of operand read and write cycles is shown in parentheses (r/w).

Table 10-5. Effective Address Calculation Times

Addressing Mode		Calculation Time
Dn	Data Register Direct	0(0/0)
An	Address Register Direct	0(0/0)
(An)	Address Register Indirect	0(0/0)
(An)+	Address Register Indirect with Postincrement	0(0/0)
-(An)	Address Register Indirect with Predecrement	0(0/0)
(d16,An)	Address Register Indirect with Displacement	0(0/0)
(d8,An,Xi+SF)	Address Register Indirect with Index and Byte Displacement	0(0/0)
(bd,An,Xi+SF)	Address Register Indirect with Index and Base (16-, 32-bit) Displacement	1(0/0)
((bd,An),Xn),od	Memory Indirect Preindexed Mode	3(1/0)
((bd,An),Xn),od	Memory Indirect Postindexed Mode	3(1/0)
(xxx).W	Absolute Short	0(0/0)
(xxx).L	Absolute Long	0(0/0)
(d16,PC)	Program Counter with Displacement	0(0/0)
(d8,PC,Xi+SF)	Program Counter with Index and Byte Displacement	0(0/0)
(bd,PC,Xi+SF)	Program Counter with Index and Base (16-, 32-bit) Displacement	1(0/0)
#<data>	Immediate	0(0/0)
((bd,PC,Xn),od)	Program Counter Memory Indirect Preindexed Mode	3(1/0)
((bd,PC),Xn),od	Program Counter Memory Indirect Postindexed Mode	3(1/0)

The following rules apply to any effective address calculation:

- The size of the index register (Xi) and the scale factor (SF) do not affect the calculation time for the indexed addressing modes.
- The size of the absolute address (short, long) does not affect its calculation time. In subsequent tables, the nomenclature "(xxx).WL" is used to denote either the absolute short {(xxx).W} or absolute long {(xxx).L} addressing modes.

In general, the use of a memory indirect effective address adds three cycles to the instruction execution times (one cycle to process full format effective address and two cycles to fetch the memory indirect pointer). For instructions which calculate both a source and destination address (e.g., memory-to-memory moves), two effective address calculations are performed, one for the source and another for the destination.

10.5 MOVE INSTRUCTION EXECUTION TIMES

Table 10-6 and Table 10-7 show the number of clock cycles for execution of the MOVE instruction. The number of operand read and write cycles is shown in parentheses (r/w). Note, if memory indirect addressing is used for a MOVE instruction, add 2(1/0) cycles for

each memory indirect address to the numbers in Table 10-6 and Table 10-7. The execution times for the MOVE16 instruction are shown in Table 10-8.

Table 10-6. Move Byte and Word Execution Times

Source	Destination								
	Dn	An	(An)	(An)+	-(An)	(d16,An)	(d8,An,Xi+SF)	(bd,An,Xi+SF)	(xxx).WL
Dn	1(0/0)	1(0/0)	1(0/1)	1(0/1)	1(0/1)	1(0/1)	1(0/1)	2(0/1)	1(0/1)
An	1(0/0)	1(0/0)	1(0/1)	1(0/1)	1(0/1)	1(0/1)	1(0/1)	2(0/1)	1(0/1)
(An)	1(1/0)	1(1/0)	2(1/1)	2(1/1)	2(1/1)	2(1/1)	2(1/1)	3(1/1)	2(1/1)
(An)+	1(1/0)	1(1/0)	2(1/1)	2(1/1)	2(1/1)	2(1/1)	2(1/1)	3(1/1)	2(1/1)
-(An)	1(1/0)	1(1/0)	2(1/1)	2(1/1)	2(1/1)	2(1/1)	2(1/1)	3(1/1)	2(1/1)
(d16,An)	1(1/0)	1(1/0)	2(1/1)	2(1/1)	2(1/1)	2(1/1)	2(1/1)	3(1/1)	2(1/1)
(d8,An,Xi+SF)	1(1/0)	1(1/0)	2(1/1)	2(1/1)	2(1/1)	2(1/1)	2(1/1)	3(1/1)	2(1/1)
(bd,An,Xi+SF)	2(1/0)	2(1/0)	3(1/1)	3(1/1)	3(1/1)	3(1/1)	3(1/1)	4(1/1)	3(1/1)
(xxx).W	1(1/0)	1(1/0)	2(1/1)	2(1/1)	2(1/1)	2(1/1)	2(1/1)	3(1/1)	2(1/1)
(xxx).L	1(1/0)	1(1/0)	2(1/1)	2(1/1)	2(1/1)	2(1/1)	2(1/1)	3(1/1)	2(1/1)
(d16,PC)	1(1/0)	1(1/0)	2(1/1)	2(1/1)	2(1/1)	2(1/1)	2(1/1)	3(1/1)	2(1/1)
(d8,PC,Xi+SF)	1(1/0)	1(1/0)	2(1/1)	2(1/1)	2(1/1)	2(1/1)	2(1/1)	3(1/1)	2(1/1)
(bd,PC,Xi+SF)	2(1/0)	2(1/0)	3(1/1)	3(1/1)	3(1/1)	3(1/1)	3(1/1)	4(1/1)	3(1/1)
#<data>	1(0/0)	1(0/0)	1(0/1)	1(0/1)	1(0/1)	2(0/1)	2(0/1)	3(0/1)	2(0/1)

Table 10-7. Move Long Execution Times

Source	Destination								
	Dn	An	(An)	(An)+	-(An)	(d16,An)	(d8,An,Xi+SF)	(bd,An,Xi+SF)	(xxx).WL
Dn	1(0/0)	1(0/0)	1(0/1)	1(0/1)	1(0/1)	1(0/1)	1(0/1)	2(0/1)	1(0/1)
An	1(0/0)	1(0/0)	1(0/1)	1(0/1)	1(0/1)	1(0/1)	1(0/1)	2(0/1)	1(0/1)
(An)	1(1/0)	1(1/0)	2(1/1)	2(1/1)	2(1/1)	2(1/1)	2(1/1)	3(1/1)	2(1/1)
(An)+	1(1/0)	1(1/0)	2(1/1)	2(1/1)	2(1/1)	2(1/1)	2(1/1)	3(1/1)	2(1/1)
-(An)	1(1/0)	1(1/0)	2(1/1)	2(1/1)	2(1/1)	2(1/1)	2(1/1)	3(1/1)	2(1/1)
(d16,An)	1(1/0)	1(1/0)	2(1/1)	2(1/1)	2(1/1)	2(1/1)	2(1/1)	3(1/1)	2(1/1)
(d8,An,Xi+SF)	1(1/0)	1(1/0)	2(1/1)	2(1/1)	2(1/1)	2(1/1)	2(1/1)	3(1/1)	2(1/1)
(bd,An,Xi+SF)	2(1/0)	2(1/0)	3(1/1)	3(1/1)	3(1/1)	3(1/1)	3(1/1)	4(1/1)	3(1/1)
(xxx).W	1(1/0)	1(1/0)	2(1/1)	2(1/1)	2(1/1)	2(1/1)	2(1/1)	3(1/1)	2(1/1)
(xxx).L	1(1/0)	1(1/0)	2(1/1)	2(1/1)	2(1/1)	2(1/1)	2(1/1)	3(1/1)	2(1/1)
(d16,PC)	1(1/0)	1(1/0)	2(1/1)	2(1/1)	2(1/1)	2(1/1)	2(1/1)	3(1/1)	2(1/1)
(d8,PC,Xi+SF)	1(1/0)	1(1/0)	2(1/1)	2(1/1)	2(1/1)	2(1/1)	2(1/1)	3(1/1)	2(1/1)
(bd,PC,Xi+SF)	2(1/0)	2(1/0)	3(1/1)	3(1/1)	3(1/1)	3(1/1)	3(1/1)	4(1/1)	3(1/1)
#<data>	1(0/0)	1(0/0)	1(0/1)	1(0/1)	1(0/1)	2(0/1)	2(0/1)	3(0/1)	2(0/1)

10

Table 10-8. MOVE16 Execution Times

Source	Destination		
	(Ax)	(Ax)+	(xxx).L
(Ay)	—	—	18(1/1) ¹
(Ay)+	—	18(1/1) ¹	18(1/1) ¹
(xxx).L	18(1/1) ¹	18(1/1) ¹	—

¹ These execution times assume cache misses for both read and write MOVE16 accesses. Execution times are 11(1/1) if the read access hits in the operand data cache. Note, for this instruction the operand read/write refers to a line-sized transfer

Instruction Execution Timing

10.6 STANDARD INSTRUCTION EXECUTION TIMES

Table 10-9 shows the number of clock cycles required for execution of the standard instructions, including completion of the operation and storing of the result. The number of operand read and write cycles is shown in parentheses (r/w). In this table, <ea> denotes any effective address and <M> denotes a memory operand. For all instructions in Table 10-9, the clock cycles and r/w cycles for the effective address calculation (Table 10-5) must be added to the values listed.

Table 10-9. Standard Instruction Execution Time

Instruction	Size	op <ea>,An ¹	op <ea>,Dn	op Dn,<M>
ADD	Byte, Word	1(1/0)	1(1/0)	1(1/1)
"	Long	1(1/0)	1(1/0)	1(1/1)
AND	Byte, Word	—	1(1/0)	1(1/1)
"	Long	—	1(1/0)	1(1/1)
CMP	Byte, Word	1(1/0)	1(1/0)	—
"	Long	1(1/0)	1(1/0)	—
DIVS	Word	—	<=22(1/0) ²	—
"	Long ³	—	38(1/0)	—
DIVU	Word	—	<=22(1/0) ²	—
"	Long ³	—	38(1/0)	—
EOR	Byte, Word	—	1(1/0)	1(1/1)
"	Long	—	1(1/0)	1(1/1)
MULS	Word	—	2(1/0)	—
"	Long ³	—	2(1/0)	—
MULU	Word	—	2(1/0)	—
"	Long ³	—	2(1/0)	—
OR	Byte, Word	—	1(1/0)	1(1/1)
"	Long	—	1(1/0)	1(1/1)
SUB	Byte, Word	1(1/0)	1(1/0)	1(1/1)
"	Long	1(1/0)	1(1/0)	1(1/1)

¹ For entries in this column, add one cycle if the <ea> is (Ay)+, -(Ay) and Ay = An

² Word divides have conditional exit points.

³ Add one cycle to the effective address calculation time for all addressing modes except Rn, (An), (An)+, -(An), (d16,An), and (d16,PC)

10.7 IMMEDIATE INSTRUCTION EXECUTION TIMES

Table 10-10 shows the number of clock cycles required for execution of the immediate instructions, including completion of the operation and storing of the result. The number of operand read and write cycles is shown in parentheses (r/w).

Table 10-10. Immediate Instruction Execution Times

Instruction	Size	Destination								
		Dn	An	(An)	(An) +	-(An)	(d16,An)	(d8,An,Xi*SF)	(bd,An,Xi*SF) ¹	(xxx).WL
ADDI	Byte, Word	1(0/0)	—	1(1/1)	1(1/1)	1(1/1)	2(1/1)	2(1/1)	3(1/1)	2(1/1)
"	Long	1(0/0)	—	1(1/1)	1(1/1)	1(1/1)	2(1/1)	2(1/1)	3(1/1)	2(1/1)
ADDQ	Byte, Word	1(0/0)	1(0/0)	1(1/1)	1(1/1)	1(1/1)	1(1/1)	1(1/1)	2(1/1)	1(1/1)
"	Long	1(0/0)	1(0/0)	1(1/1)	1(1/1)	1(1/1)	1(1/1)	1(1/1)	2(1/1)	1(1/1)
ANDI	Byte, Word	1(0/0)	—	1(1/1)	1(1/1)	1(1/1)	2(1/1)	2(1/1)	3(1/1)	2(1/1)
"	Long	1(0/0)	—	1(1/1)	1(1/1)	1(1/1)	2(1/1)	2(1/1)	3(1/1)	2(1/1)
CMPI	Byte, Word	1(0/0)	—	1(1/0)	1(1/0)	1(1/0)	2(1/0)	2(1/0)	3(1/0)	2(1/0)
"	Long	1(0/0)	—	1(1/0)	1(1/0)	1(1/0)	2(1/0)	2(1/0)	3(1/0)	2(1/0)
EORI	Byte, Word	1(0/0)	—	1(1/1)	1(1/1)	1(1/1)	2(1/1)	2(1/1)	3(1/1)	2(1/1)
"	Long	1(0/0)	—	1(1/1)	1(1/1)	1(1/1)	2(1/1)	2(1/1)	3(1/1)	2(1/1)
MOVEQ	Long	1(0/0)	—	—	—	—	—	—	—	—
ORI	Byte, Word	1(0/0)	—	1(1/1)	1(1/1)	1(1/1)	2(1/1)	2(1/1)	3(1/1)	2(1/1)
"	Long	1(0/0)	—	1(1/1)	1(1/1)	1(1/1)	2(1/1)	2(1/1)	3(1/1)	2(1/1)
SUBI	Byte, Word	1(0/0)	—	1(1/1)	1(1/1)	1(1/1)	2(1/1)	2(1/1)	3(1/1)	2(1/1)
"	Long	1(0/0)	—	1(1/1)	1(1/1)	1(1/1)	2(1/1)	2(1/1)	3(1/1)	2(1/1)
SUBQ	Byte, Word	1(0/0)	1(0/0)	1(1/1)	1(1/1)	1(1/1)	1(1/1)	1(1/1)	2(1/1)	1(1/1)
"	Long	1(0/0)	1(0/0)	1(1/1)	1(1/1)	1(1/1)	1(1/1)	1(1/1)	2(1/1)	1(1/1)

¹ Add 2(1/0) cycles to the (bd,An,Xi*SF) time for a memory indirect address.

Instruction Execution Timing

10.8 SINGLE-OPERAND INSTRUCTION EXECUTION TIMES

Table 10-11 shows the number of clock cycles required for execution of the single-operand instructions. The number of operand reads and write cycles is shown in parentheses (r/w). Where indicated, the number of clock cycles and r/w cycles must be added to those required for effective address calculation.

Table 10-11. Single-Operand Instruction Execution Times

Instruction	Size	Register	Memory
CAS	Byte, Word ¹	—	19(1/1)
"	Long ¹	—	19(1/1)
NBCD	Byte	1(0/0)	1(1/1) ²
NEG	Byte, Word	1(0/0)	1(1/1) ²
"	Long	1(0/0)	1(1/1) ²
NEGX	Byte, Word	1(0/0)	1(1/1) ²
"	Long	1(0/0)	1(1/1) ²
NOT	Byte, Word	1(0/0)	1(1/1) ²
"	Long	1(0/0)	1(1/1) ²
Scc	Byte -> False	1(0/0)	1(1/1) ²
"	Byte -> True	1(0/0)	1(1/1) ²
TAS	Byte	1(0/0)	17(1/1) ²
TST	Byte, Word	1(0/0)	1(1/0) ²
"	Long	1(0/0)	1(1/0) ²

¹ Add (1 + effective address calculation time) cycles for all addressing modes except Rn, (An), (An)+, -(An), and (d16,An).

² Add the effective address calculation time to these instructions.

Execution times for the CLR instruction are given in Table 10-12. The number of operand reads and writes is shown in parentheses (r/w).

Table 10-12. Clear (CLR) Execution Times

Size	Dn	A _n	(An)	(An)+	-(An)	(d16,An)	(d8,An,Xi+SF)	(bd,An,Xi+SF) ¹	(xxx).WL
Byte, Word	1(0/0)	—	1(0/1)	1(0/1)	1(0/1)	1(0/1)	1(0/1)	2(0/1)	1(0/1)
Long	1(0/0)	—	1(0/1)	1(0/1)	1(0/1)	1(0/1)	1(0/1)	2(0/1)	1(0/1)

¹ Add 2(1/0) cycles to the (bd,An,Xi+SF) time for a memory indirect address.

10.9 SHIFT/ROTATE EXECUTION TIMES

Table 10-13 indicates the number of clock cycles required for execution of the shift and rotate instructions. The number of operand read and write cycles is shown in parentheses (r/w). Where indicated, the number of clock cycles and r/w cycles must be added to those required for effective address calculation.

Table 10-13. Shift/Rotate Execution Times

Instruction	Size	Register	Memory ¹
ASL, ASR	Byte, Word	1(0/0)	1(1/1)
"	Long	1(0/0)	—
LSL, LSR	Byte, Word	1(0/0)	1(1/1)
"	Long	1(0/0)	—
ROL, ROR	Byte, Word	1(0/0)	1(1/1)
"	Long	1(0/0)	—
ROXL, ROXR	Byte, Word	1(0/0)	1(1/1)
"	Long	1(0/0)	—

¹ For entries in this column, add the effective address calculation time. These operations are word-size only.

10.10 BIT MANIPULATION AND BIT FIELD EXECUTION TIMES

Table 10-14 and Table 10-15 indicate the number of clock cycles required for execution of the bit manipulation instructions. The execution times for the bit field instructions is shown in Table 10-16. The number of operand read and write cycles is shown in parentheses (r/w). Where indicated, the number of clock cycles and r/w cycles must be added to those required for effective address calculation.

Table 10-14. Bit Manipulation (Dynamic Bit Count) Execution Times

Instruction	Size	Register	Memory ¹
BCHG	Byte	—	1(1/1)
"	Long	1(0/0)	—
BCLR	Byte	—	1(1/1)
"	Long	1(0/0)	—
BSET	Byte	—	1(1/1)
"	Long	1(0/0)	—
BTST	Byte	—	1(1/0)
"	Long	1(0/0)	—

¹ For entries in this column, add the effective address calculation time.

Instruction Execution Timing

Table 10-15. Bit Manipulation (Static Bit Count) Execution Times

Instruction	Size	Destination								
		Dn	An	(An)	(An)+	-(An)	(d16,An)	(d8,An,Xi+SF)	(bd,An,Xi+SF) ¹	(xxx).WL
BCHG	Byte	—	—	1(1/1)	1(1/1)	1(1/1)	2(1/1)	2(1/1)	3(1/1)	2(1/1)
"	Long	1(0/0)	—	—	—	—	—	—	—	—
BCLR	Byte	—	—	1(1/1)	1(1/1)	1(1/1)	2(1/1)	2(1/1)	3(1/1)	2(1/1)
"	Long	1(0/0)	—	—	—	—	—	—	—	—
BSET	Byte	—	—	1(1/1)	1(1/1)	1(1/1)	2(1/1)	2(1/1)	3(1/1)	2(1/1)
"	Long	1(0/0)	—	—	—	—	—	—	—	—
BTST	Byte	—	—	1(1/0)	1(1/0)	1(1/0)	2(1/0)	2(1/0)	3(1/0)	2(1/0)
"	Long	1(0/0)	—	—	—	—	—	—	—	—

¹ Add 2(1/0) cycles to the (bd,An,Xi+SF) time for a memory indirect address.

Table 10-16. Bit Field Execution Times¹

Instruction	Destination								
	Dn	An	(An)	(An)+	-(An)	(d16,An)	(d8,An,Xi+SF)	(bd,An,Xi+SF) ²	(xxx).WL
BFCHG (< 5 Bytes)	8(0/0)	—	8(2/1)	—	—	8(2/1)	9(2/1)	10(2/1)	9(2/1)
BFCHG(= 5 Bytes)	12(0/0)	—	12(4/2)	—	—	12(4/2)	13(4/2)	14(4/2)	13(4/2)
BFCLR (< 5 Bytes)	8(0/0)	—	8(2/1)	—	—	8(2/1)	9(2/1)	10(2/1)	9(2/1)
BFCLR(= 5 Bytes)	12(0/0)	—	12(4/2)	—	—	12(4/2)	13(4/2)	14(4/2)	13(4/2)
BFEXTS(< 5 Bytes)	6(0/0)	—	6(1/0)	—	—	6(1/0)	7(1/0)	8(1/0)	7(1/0)
BFEXTS(= 5 Bytes)	8(0/0)	—	8(2/0)	—	—	8(2/0)	9(2/0)	10(2/0)	9(2/0)
BFEXTU(< 5 Bytes)	6(0/0)	—	6(1/0)	—	—	6(1/0)	7(1/0)	8(1/0)	7(1/0)
BFEXTU(= 5 Bytes)	8(0/0)	—	8(2/0)	—	—	8(2/0)	9(2/0)	10(2/0)	9(2/0)
BFFFO(< 5 Bytes)	9(0/0)	—	9(1/0)	—	—	9(1/0)	10(1/0)	11(1/0)	10(1/0)
BFFFO(= 5 Bytes)	11(0/0)	—	11(2/0)	—	—	11(2/0)	12(2/0)	13(2/0)	12(2/0)
BFINS (< 5 Bytes)	6(0/0)	—	6(1/1)	—	—	6(1/1)	7(1/1)	8(1/1)	7(1/1)
BFINS(= 5 Bytes)	6(0/0)	—	6(2/2)	—	—	6(2/2)	7(2/2)	8(2/2)	7(2/2)
BFSET (< 5 Bytes)	8(0/0)	—	8(2/1)	—	—	8(2/1)	9(2/1)	10(2/1)	9(2/1)
BFSET(= 5 Bytes)	12(0/0)	—	12(4/2)	—	—	12(4/2)	13(4/2)	14(4/2)	13(4/2)
BFTST (< 5 Bytes)	6(0/0)	—	6(1/0)	—	—	6(1/0)	7(1/0)	8(1/0)	7(1/0)
BFTST(= 5 Bytes)	8(0/0)	—	8(2/0)	—	—	8(2/0)	9(2/0)	10(2/0)	9(2/0)

¹ The type of offset and width (static, dynamic) does not affect the execution time.

² Add 2(1/0) cycles to the (bd,An,Xi+SF) time for a memory indirect address.

10.11 BRANCH INSTRUCTION EXECUTION TIMES

Table 10-17, Table 10-18, and Table 10-19 indicate the number of clock cycles required for execution of the branch, jump, and return instructions. The number of operand read and write cycles is shown in parentheses (r/w). Where indicated, the number of clock cycles and r/w cycles must be added to those required for effective address calculation.

Table 10-17. Branch Execution Times

Instruction	Not Predicted, Forward, Taken	Not Predicted, Forward, Not Taken	Not Predicted, Backward, Taken	Not Predicted, Backward, Not Taken	Predicted Correctly as Taken	Predicted Correctly as Not Taken	Predicted Incorrectly
Bcc	7(0/0)	1(0/0)	3(0/0)	7(0/0)	0(0/0)	1(0/0)	7(0/0)
BRA	3(0/0)	—	3(0/0)	—	0(0/0)	—	—
BSR	3(0/1)	—	3(0/1)	—	1(0/1)	—	—
DBcc	3(0/0)	8(0/0)	3(0/0)	8(0/0)	2(0/0)	2(0/0)	8(0/0)
DBRA	3(0/0)	7(0/0)	3(0/0)	7(0/0)	1(0/0)	1(0/0)	7(0/0)
FBcc	8(0/0)	2(0/0)	8(0/0)	2(0/0)	2(0/0)	2(0/0)	8(0/0)

Table 10-18. JMP, JSR Execution Times¹

Instruction	Not Predicted, Forward, Taken	Not Predicted, Forward, Not Taken	Not Predicted, Backward, Taken	Not Predicted, Backward, Not Taken	Predicted Correctly as Taken	Predicted Correctly as Not Taken	Predicted Incorrectly
JMP (d16,PC)	3(0/0)	—	3(0/0)	—	0(0/0)	—	—
JMP xxx.WL	3(0/0)	—	3(0/0)	—	0(0/0)	—	—
Remaining JMP	5(0/0)	—	5(0/0)	—	5(0/0)	—	—
JSR (d16,PC)	3(0/1)	—	3(0/1)	—	1(0/1)	—	—
JSR xxx.WL	3(0/1)	—	3(0/1)	—	1(0/1)	—	—
Remaining JSR	5(0/1)	—	5(0/1)	—	5(0/1)	—	—

¹Add the effective address calculation time for each entry.

Table 10-19. Return Instruction Execution Times

Instruction	Execution Time
RTD	7(1/0)
RTE	17(3/0)
RTR	8(2/0)
RTS	7(1/0)

Instruction Execution Timing

10.12 LEA, PEA, AND MOVEM EXECUTION TIMES

Table 10-20 indicates the number of clock cycles required for execution of the LEA, PEA, and MOVEM instructions. The number of operand read and write cycles is shown in parentheses (r/w).

Table 10-20. LEA, PEA, and MOVEM Instruction Execution Times

Instruction	(An)	(An) +	-(An)	(d16,An)	(d8,An, Xi+SF)	(bd,An, Xi+SF) ¹	(xxx).WL	(d16,PC)	(d8,PC, Xi+SF)	(bd,PC, Xi+SF) ¹
LEA	1(0/0)	-	-	1(0/0)	1(0/0)	2(0/0)	1(0/0)	1(0/0)	1(0/0)	2(0/0)
PEA	1(0/1)	-	-	2(0/1)	2(0/1)	3(0/1)	1(0/1)	1(0/1)	2(0/1)	2(0/1)
MOVEM Mem->Reg	n ² (n/ 0)	n(n/ 0)	-	n(n/0)	1+n(n/0)	2+n(n/0)	1+n(n/0)	n(n/0)	1+n(n/0)	2+n(n/0)
MOVEM Reg->Mem	n(0/n)	—	n(0/ n)	n(0/n)	1+n(0/n)	2+n(0/n)	1+n(0/n)	—	—	—

¹ Add 2(1/0) cycles to the (bd,{An,PC},Xi+SF) time for a memory indirect address.

² "n" is the number of registers being moved.

10.13 MULTIPRECISION INSTRUCTION EXECUTION TIMES

Table 10-21 indicates the number of clock cycles for execution of the multiprecision instructions. The number of clock cycles includes the time to fetch both operands, perform the operations, and store the results. The number of read and write cycles is shown in parentheses (r/w).

Table 10-21. Multiprecision Instruction Execution Times

Instruction	Size	op Dy,Dx	op <ea>y,<ea>x ¹
ADDX	Byte, Word	1(0/0)	2(2/1)
"	Long	1(0/0)	2(2/1)
CMPM	Byte, Word	—	2(2/0)
"	Long	—	2(2/0)
SUBX	Byte, Word	1(0/0)	2(2/1)
"	Long	1(0/0)	2(2/1)
ABCD	Byte	1(0/0)	2(2/1)
SBCD	Byte	1(0/0)	2(2/1)

¹ Where <ea>y,<ea>x is (Ay)+,(Ax)+ for CMPM and -(Ay),-(Ax) for all other instructions.

10.14 STATUS REGISTER, MOVES, AND MISCELLANEOUS INSTRUCTION EXECUTION TIMES

Table 10-22, Table 10-23, and Table 10-24 indicate the number of clock cycles required for execution of the status register, MOVES, and miscellaneous instructions. The number of operand read and write cycles is shown in parentheses (r/w). Where indicated, the number of clock cycles and r/w cycles must be added to those required for effective address calculation.

Table 10-22. Status Register (SR) Instruction Execution Times

Instruction	Execution Time
ANDI to SR	12(0/0)
EORI to SR	12(0/0)
MOVE from SR	1(0/1) ¹
MOVE to SR	12(1/0) ¹
ORI to SR	5(0/0)

¹ For these instructions, add the effective address calculation time.

Table 10-23. MOVES Execution Times

MOVES Function	Destination							
	Size	(An)	(An)+	-(An)	(d16,An)	(d8,An,Xi+SF)	(bd,An,Xi+SF) ¹	(xxx).WL
Source<SFC> -> Rn	Byte, Word	1(1/0)	1(1/0)	1(1/0)	1(1/0)	2(1/0)	3(1/0)	2(1/0)
"	Long	1(1/0)	1(1/0)	1(1/0)	1(1/0)	2(1/0)	3(1/0)	2(1/0)
Rn -> Dest <DFC>	Byte, Word	1(0/1)	1(0/1)	1(0/1)	1(0/1)	2(0/1)	3(0/1)	2(0/1)
"	Long	1(0/1)	1(0/1)	1(0/1)	1(0/1)	2(0/1)	3(0/1)	2(0/1)

¹ Add 2(1/0) cycles to the (bd,An,Xi+SF) time for a memory indirect address.

Table 10-24. Miscellaneous Instruction Execution Times

Instruction	Size	Register	Memory	Reg -> Dest	Source -> Reg
ANDI to CCR	Byte	1(0/0)	—	—	—
CHK	Word	2(0/0)	2(1/0) ¹	—	—
"	Long	2(0/0)	2(1/0) ¹	—	—
CINVA	—	—	<=17(0/0)	—	—
CINVL	—	—	<=18(0/0)	—	—
CINVP	—	—	<=274(0/0)	—	—
CPUSHA	—	—	<=5394(0/512) ²	—	—
CPUSHL	—	—	<=26(0/1) ²	—	—
CPUSHP	—	—	<=2838(0/256) ²	—	—
EORI to CCR	Byte	1(0/0)	—	—	—
EXG	Long	1(0/0)	—	—	—
EXT	Word	1(0/0)	—	—	—
"	Long	1(0/0)	—	—	—
EXTB	Long	1(0/0)	—	—	—
LINK	Word	2(0/1)	—	—	—
"	Long	2(0/1)	—	—	—
LPSTOP	Word	15(0/1)	—	—	—
MOVE from CCR	Word	1(0/0)	1(0/1) ¹	—	—
MOVE to CCR	Word	1(0/0)	1(1/0) ¹	—	—
MOVE from USP	Long	1(0/0)	—	—	—
MOVE to USP	Long	2(0/0)	—	—	—
MOVEC (SFC,DFC, USP,VBR,PCR)	Long	—	—	12(0/0)	11(0/0)
MOVEC (CACR,TC, TTR,BUSCR,URP,SRP)	Long	—	—	15(0/0)	14(0/0)
NOP	—	9(0/0)	—	—	—
ORI to CCR	Byte	1(0/0)	—	—	—
PACK	—	2(0/0)	2(1/1)	—	—

Instruction Execution Timing

Table 10-24. Miscellaneous Instruction Execution Times (Continued)

Instruction	Size	Register	Memory	Reg -> Dest	Source -> Reg
PLPA (ATC hit)	—	15(0/0)	—	—	—
PLPA (ATC miss)	—	28(0/0)	—	—	—
PFLUSH	—	18(0/0)	—	—	—
PFLUSHN	—	18(0/0)	—	—	—
PFLUSHAN	—	33(0/0)	—	—	—
PFLUSHA	—	33(0/0)	—	—	—
RESET	—	520(0/0)	—	—	—
STOP	Word	8(0/0)	—	—	—
SWAP	Word	1(0/0)	—	—	—
TRAPF	—	1(0/0)	—	—	—
TRAPcc	—	1(0/0)	—	—	—
TRAPV	—	1(0/0)	—	—	—
UNLK	—	1(1/0)	—	—	—
UNPK	—	2(0/0)	2(1/1)	—	—

¹ For these entries, add the effective address calculation time.

² For the CPUSH instruction, the operand write figure refers to line-sized transfers.

10.15 FPU INSTRUCTION EXECUTION TIMES

Table 10-25 shows the number of clock cycles required for execution of the floating-point instructions, including completion of the operation and storing of the result. The number of operand read and write cycles is shown in parentheses (r/w).

Table 10-25. Floating-Point Instruction Execution Times

Instruction	Effective Address, <ea>									
	FPn	Dn	(An)	(An)+	-(An)	(d16,An) (d16,PC)	(d8,An,Xi+SF) (d8,PC,Xi+SF)	(bd,An,Xi+SF) (bd,PC,Xi+SF)	(xxx).WL	#<imm>
FABS	1(0/0)	3(0/0)	1(1/0)	1(1/0)	1(1/0)	1(1/0)	2(1/0)	3(1/0)	2(1/0)	2(0/0)
FDABS	1(0/0)	3(0/0)	1(1/0)	1(1/0)	1(1/0)	1(1/0)	2(1/0)	3(1/0)	2(1/0)	2(0/0)
FSABS	1(0/0)	3(0/0)	1(1/0)	1(1/0)	1(1/0)	1(1/0)	2(1/0)	3(1/0)	2(1/0)	2(0/0)
FADD	3(0/0)	5(0/0)	3(1/0)	3(1/0)	3(1/0)	3(1/0)	4(1/0)	5(1/0)	4(1/0)	4(0/0)
FDADD	3(0/0)	5(0/0)	3(1/0)	3(1/0)	3(1/0)	3(1/0)	4(1/0)	5(1/0)	4(1/0)	4(0/0)
FSADD	3(0/0)	5(0/0)	3(1/0)	3(1/0)	3(1/0)	3(1/0)	4(1/0)	5(1/0)	4(1/0)	4(0/0)
FCMP	1(0/0)	3(0/0)	1(1/0)	1(1/0)	1(1/0)	1(1/0)	2(1/0)	3(1/0)	2(1/0)	2(0/0)
FDIV	37(0/0)	39(0/0)	37(1/0)	37(1/0)	37(1/0)	37(1/0)	38(1/0)	39(1/0)	38(1/0)	38(0/0)
FDDIV	37(0/0)	39(0/0)	37(1/0)	37(1/0)	37(1/0)	37(1/0)	38(1/0)	39(1/0)	38(1/0)	38(0/0)
FSDIV	37(0/0)	39(0/0)	37(1/0)	37(1/0)	37(1/0)	37(1/0)	38(1/0)	39(1/0)	38(1/0)	38(0/0)
FMOVE _FPx	1(0/0)	3(0/0)	1(1/0)	1(1/0)	1(1/0)	1(1/0)	2(1/0)	3(1/0)	2(1/0)	1(0/0)
FDMOVE _FPx	1(0/0)	3(0/0)	1(1/0)	1(1/0)	1(1/0)	1(1/0)	2(1/0)	3(1/0)	2(1/0)	1(0/0)
FSMOVE _FPx	1(0/0)	3(0/0)	1(1/0)	1(1/0)	1(1/0)	1(1/0)	2(1/0)	3(1/0)	2(1/0)	1(0/0)
FMOVE _FPy	—	3(0/0)	1(0/1)	1(0/1)	1(0/1)	1(1/0)	2(0/1)	3(0/1)	2(0/1)	—
FMOVE _FPCR	—	8(0/0)	6(1/0)	6(1/0)	6(1/0)	6(1/0)	7(1/0)	8(1/0)	7(1/0)	7(0/0)
FMOVE _FPCR	—	4(0/0)	2(0/1)	2(0/1)	2(0/1)	2(1/0)	3(0/1)	4(0/1)	3(0/1)	—
FINT	3(0/0)	4(0/0)	3(1/0)	3(1/0)	3(1/0)	3(1/0)	3(1/0)	5(1/0)	3(1/0)	3(0/0)
FINTRZ	3(0/0)	4(0/0)	3(1/0)	3(1/0)	3(1/0)	3(1/0)	3(1/0)	5(1/0)	3(1/0)	3(0/0)

Table 10-25. Floating-Point Instruction Execution Times (Continued)

Instruction	Effective Address, <ea>									
	FPn	Dn	(An)	(An)+	-(An)	(d16,An) (d16,PC)	(d8,An,Xi+SF) (d8,PC,Xi+SF)	(bd,An,Xi+SF) (bd,PC,Xi+SF)	(xxx).WL	#<imm>
FSGLDIV	37(0/0)	39(0/0)	37(1/0)	37(1/0)	37(1/0)	37(1/0)	38(1/0)	39(1/0)	38(1/0)	38(0/0)
FSGLMUL	3(0/0)	5(0/0)	3(1/0)	3(1/0)	3(1/0)	3(1/0)	4(1/0)	5(1/0)	4(1/0)	4(0/0)
FMOVEM FPx*	—	—	1+3n (3n/0)	1+3n (3n/0)	—	1+3n(3n/0)	2+3n(3n/0)	3+3n(3n/0)	2+3n(3n/0)	—
FMOVEM FPy*	—	—	1+3n (0/3n)	—	1+3n (0/3n)	1+3n(0/3n)	2+3n(0/3n)	3+3n(0/3n)	2+3n(0/3n)	—
FMUL	3(0/0)	5(0/0)	3(1/0)	3(1/0)	3(1/0)	3(1/0)	4(1/0)	5(1/0)	4(1/0)	4(0/0)
FDMUL	3(0/0)	5(0/0)	3(1/0)	3(1/0)	3(1/0)	3(1/0)	4(1/0)	5(1/0)	4(1/0)	4(0/0)
FSMUL	3(0/0)	5(0/0)	3(1/0)	3(1/0)	3(1/0)	3(1/0)	4(1/0)	5(1/0)	4(1/0)	4(0/0)
FNEG	1(0/0)	3(0/0)	1(1/0)	1(1/0)	1(1/0)	1(1/0)	2(1/0)	3(1/0)	2(1/0)	2(0/0)
FDNEG	1(0/0)	3(0/0)	1(1/0)	1(1/0)	1(1/0)	1(1/0)	2(1/0)	3(1/0)	2(1/0)	2(0/0)
FSNEG	1(0/0)	3(0/0)	1(1/0)	1(1/0)	1(1/0)	1(1/0)	2(1/0)	3(1/0)	2(1/0)	2(0/0)
FSUB	3(0/0)	5(0/0)	3(1/0)	3(1/0)	3(1/0)	3(1/0)	4(1/0)	5(1/0)	4(1/0)	3(0/0)
FDSUB	3(0/0)	5(0/0)	3(1/0)	3(1/0)	3(1/0)	3(1/0)	4(1/0)	5(1/0)	4(1/0)	3(0/0)
FSSUB	3(0/0)	5(0/0)	3(1/0)	3(1/0)	3(1/0)	3(1/0)	4(1/0)	5(1/0)	4(1/0)	3(0/0)
FTST	1(0/0)	3(0/0)	1(1/0)	1(1/0)	1(1/0)	1(1/0)	2(1/0)	3(1/0)	2(1/0)	1(0/0)
FSQRT	68(0/0)	70(0/0)	68(1/0)	68(1/0)	68(1/0)	68(1/0)	69(1/0)	70(1/0)	69(1/0)	69(0/0)
FSSQRT	68(0/0)	70(0/0)	68(1/0)	68(1/0)	68(1/0)	68(1/0)	69(1/0)	70(1/0)	69(1/0)	69(0/0)
FDSQRT	68(0/0)	70(0/0)	68(1/0)	68(1/0)	68(1/0)	68(1/0)	69(1/0)	70(1/0)	69(1/0)	69(0/0)
FSAVE	—	—	3(0/3)	—	—	—	—	—	—	—
FRE- STORE	—	—	6(3/0)	—	—	—	—	—	—	—
FMOVEM FPxR	—	—	7(n/0)	—	—	—	—	—	—	—
FMOVEM FPxR,	—	—	5(0/n)	—	—	—	—	—	—	—

NOTES:

"n" is the number of registers being moved.

For all FPU operations, if the external operand format is byte, word, or long, add three cycles to the execution time.

*For all FPU operations except FMOVEM, if the external operand format is extended precision, add two cycles to the execution time.

Add 2(1/0) cycles to the (bd,An,Xi+SF) time for a memory indirect address.

Add 1(0/0) cycle if the <ea> specifies a double precision immediate operand.

Instruction Execution Timing

10.16 EXCEPTION PROCESSING TIMES

Table 10-26 indicates the number of clock cycles required for exception processing. The number of clock cycles includes the time spent in the OEP by the instruction causing the exception, the stacking of the exception frame, the vector fetch, and the fetch of the first instruction of the exception handler routine. The number of operand read and write cycles is shown in parentheses (r/w).

Table 10-26. Exception Processing Times

Exception	Execution Time
CPU Reset	45(2/0) ¹
Bus Error	19(1/4)
Address Error	19(1/3)
Illegal Instruction	19(1/2)
Integer Divide By Zero	20(1/3) ²
CHK Instruction	20(1/3) ²
TRAPV, TRAPcc Instructions	19(1/3)
Privilege Violation	19(1/2)
Trace	19(1/3)
Line A Emulator	19(1/2)
Line F Emulator	19(1/2)
Unimplemented EA	19(1/2)
Unimplemented Integer	19(1/2)
Format Error	23(1/2)
Nonsupported FP	19(1/3)
Interrupt ³	23(1/2)
TRAP Instructions	19(1/2)
FP Branch on Unordered Condition	21(1/3)
FP Inexact Result	19(1/3) ⁴
FP Divide By Zero	19(1/3) ⁴
FP Underflow	19(1/3) ⁴
FP Operand Error	19(1/3) ⁴
FP Overflow	19(1/3) ⁴
FP Signaling NAN	19(1/3) ⁴
FP Unimplemented Data Type	19(1/3)

¹ Indicates the time from when RSTI is negated until the first instruction enters the OEP.

² For these entries, add the effective address calculation time.

³ Assumes either autovector or external vector supplied with zero wait states.

⁴ For these entries, add the instruction execution time minus 1 if a post-exception fault occurs.

SECTION 11 APPLICATIONS INFORMATION

This section describes various applications topics relating to the MC68060.

11.1 GUIDELINES FOR PORTING SOFTWARE TO THE MC68060

The following paragraphs describe the issues involved in using the MC68060 in an existing MC68040 system from a software perspective. Although this section focuses on the MC68060, many of these items apply also to the MC68EC060 and MC68LC060.

11.1.1 User Code

The MC68060 is 100% user-mode compatible with the MC68040 when utilized with the MC68060 software package (M68060SP) provided by Motorola. The M68060SP is available free of charge. **Appendix C MC68060 Software Package** discusses the procedure for porting the M68060SP.

All user-mode instructions are handled in the M68060SP, except the "TRAPF #immediate" instruction, in which the immediate value is a valid branch opcode. Use of this construct results in a branch prediction error and an access error exception is taken. This exception is indicated by the BPE bit in the fault status long word (FSLW). Although this error is recoverable in the access error handler by flushing the branch cache, performance is compromised.

In addition, the CAS (misaligned operands) and CAS2 emulation may need special handling in the access error handler. Furthermore, CAS and CAS2 emulation must not be interrupted by level 7 interrupts to prevent data corruption. Refer to **Appendix C MC68060 Software Package** for additional information.

11.1.2 Supervisor Code

Unlike the MC68040, the MC68060 implements a single supervisor stack. System software that requires the use of two supervisor stacks can still do so, but with some software overhead.

The MC68060 aids in distinguishing between an interrupt exception and a non-interrupt exception by implementing the M-bit in the status register (SR). The MC68060 does not internally use the M-bit, but it is provided for system software. The MC68060 clears the M-bit of the SR when an interrupt exception is taken. Otherwise, it is up to the system software to set the M-bit and to examine it as needed. Also note, when the MC68060 takes an exception, a minimum of one instruction is always processed before a pending interrupt is taken.

Applications Information

System software can take advantage of the conditions described above to emulate an MC68040-like interrupt handler implementation. The SR stored in the interrupt exception stack frame will contain the previous value of the M-bit. Since the first instruction of the interrupt handler is always executed prior to evaluating interrupts, a MOVE 0x2700,SR instruction can be used to disable interrupts immediately and permit the interrupt handler to move the interrupt exception stack frame from the supervisor-stack-pointer (SSP)-addressed area to an interrupt-stack-pointer (ISP)-addressed area.

11.1.2.1 INITIALIZATION CODE (RESET EXCEPTION HANDLER). When the processor emerges from reset, it enters the reset exception handler. Items that may be encountered in the reset exception handler are discussed in the following paragraphs.

11.1.2.1.1 Processor Configuration Register (PCR) (MOVEC of PCR). Immediately after reset, the MC68060 has the superscalar dispatch disabled and the floating-point unit (FPU) enabled. The PCR may be used to set up the proper environment. The PCR is accessed via the MOVEC instruction. Since this is a new MOVEC register on the MC68060, existing MC68040 code does not reference the PCR.

To properly emulate the MC68EC040 or an MC68LC040 using an MC68060, the DFP bit in the PCR must be set to disable the FPU. Disabling the FPU causes the MC68060 to create an MC68LC040- or MC68EC040-compatible stack frame when a floating-point instruction is encountered. With some modification, floating-point emulation software written for the MC68LC040 and MC68EC040 that use the stack of type 4 may then be used. However, keep in mind that there are differences in the floating-point instruction set. Also note that the stacked effective address field is different when dealing with extended precision operands using the post-increment or pre-decrement addressing modes.

The ESS bit in the PCR must be set to enable superscalar dispatch. Doing so will greatly increase system performance.

The PCR also provides the EDEBUG bit to enable the new MC68060 debug feature. This bit is not directly related to porting existing MC68040 software and should be disabled during normal operation. The EDEBUG bit is for use in debugging hardware and software problems with the aid of a logic analyzer. For more information, refer to **Section 9 IEEE 1149.1 Test (JTAG) and Debug Pipe Control Modes**.

11.1.2.1.2 Default Transparent Translation Register (MOVEC of TCR). The MC68060 provides a method of defining the cache mode, UPAX, and write protection if the logical address accessed is not mapped by paged memory management and TTRs. For this case, a transparent translation is done, and the cache mode, UPAX, write protection from the translation control register (TCR) (accessed via the MOVEC instruction) is used.

The MC68060 default translation after reset is similar to that of the MC68040 (e.g., cache mode=cacheable write-through, UPAX=00, write protection off). Since existing MC68040 code probably writes zeroes to the new TCR bits, no additional work is expected for placing the MC68060 default translation to be MC68040-like.

11.1.2.1.3 MC68060 Software Package (M68060SP). The M68060SP replaces the installation of the MC68040 floating-point software package (M68040FPSP). Software that was

used to install the M68040FPSP must be removed and then replaced with software that installs the M68060SP. Be aware that the M68060SP and the M68040FPSP share many vector table entries and that the M68040FPSP does not work properly with the MC68060.

The M68060SP must be installed before any of the new unimplemented instructions and unimplemented effective addresses are encountered.

11.1.2.1.4 Cache Control Register (CACR) (MOVEC of CACR). As with the MC68040, the MC68060 requires that the instruction and data caches be invalidated prior to their use. In addition to this, the MC68060 requires that the branch cache be invalidated prior to its use. The branch cache is cleared via the MOVEC to CACR instruction.

Care must be taken whenever the CACR is referenced in existing MC68040 code. Since the MC68040 does not implement the new CACR bits, and existing MC68040 code may reference the CACR, the new CACR bits are likely to be cleared by MC68040-code CACR writes. If this occurs, the branch cache is retained and the four-deep store buffer is disabled. Although this would not adversely affect proper operation, it significantly degrades MC68060 performance.

11.1.2.1.5 Resource Checking (Access Error Handler). Many systems use the access error handler at some time after reset to check for the existence of I/O devices or memory. Existing MC68040 systems already have to deal with the restart nature of the MC68040. However, the stack frame generated by the MC68040 is significantly different from that of the MC68060. Resource checking software that relies on the stack size information must be modified appropriately.

When upgrading to the MC68060 from an existing MC68030 or MC68020 system, porting resource checking software may be problematic because the continuation architecture (MC68030 and MC68020) allows an operand read bus error to be ignored and not re-run the offending instruction, but a restart machine such as the MC68060 has no provisions for doing so. A possible work-around for this is to either increment the stacked program counter (PC) prior to the RTE, or to use a NOP-RESOURCE_WRITE-NOP in place of the RESOURCE_READ, in imprecise exception mode, to poke at the possible resource area.

11.1.2.2 VIRTUAL MEMORY SOFTWARE. The MC68060 fully supports virtual memory. There are some slight changes that need to be made to support the MC68060 virtual memory. The following paragraphs outline issues that need to be addressed in relation to virtual memory support.

11.1.2.2.1 Translation Control Register (MOVEC of TCR) . The TCR is accessed via the MOVEC instruction, as with the MC68040. However, the TCR has newly defined bits. Since these new bits need to be cleared in normal operating mode anyway, no additional work is needed.

When the MC68040 emerges from reset, the default translation is cacheable write-through, UPAX=0, and no write protect. The MC68060 provides a means for modifying these default translation parameters. There are new bits in the MC68060 TCR to define the default translation.

Applications Information

Existing MC68040 TCR writes probably write these new bits as zeroes, which would mean that the MC68060's default translation is identical to that of the MC68040. If these bits in the TCR are non-zero, it is possible that somewhere in the existing MC68040 code, a TCR access would overwrite the desired bits to zero, hence returning the MC68040 default translation to be MC68040-like. If this is not desired, accesses to the TCR must be changed to set the appropriate bits.

11.1.2.2 Descriptors in Cacheable Copyback Pages Prohibited. The MC68040 allows the use of cacheable copyback pages to store page descriptors. The reason is that when a table search is initiated, the MC68040 examines the data cache for valid descriptors. Although the MC68040 does not allocate table descriptors into the cache on a miss, the system software that is used to set up the descriptors may allocate descriptors into the data cache.

Since the MC68060 totally ignores the data cache when performing a table search, a descriptor that resides in a cache entry that is marked valid and dirty would cause incorrect data to be used. The system software must be modified to make the pages that contain page and table descriptors to be noncacheable or cacheable writethrough to ensure coherency to avoid this situation.

11.1.2.2.3 Page and Descriptor Faults (Access Error Handler). The access error handler is entered when a table search results in an invalid table descriptor, invalid page descriptor, supervisor protection violation, write protection violation, or a bus error. In an MC68040 access error handler, table-search-related causes require the use of the PTEST instruction to determine the cause of the fault.

Given the many differences in the access error handling of the MC68060 and MC68040, it is recommended that the entire handler be replaced. Refer to **Section 8 Exception Processing** for information on recovering from an access error.

Note that on unsuccessful table searches, the processor does not allocate an invalid address translation cache (ATC) entry; therefore, a PFLUSH is not necessary to remove the invalid ATC entry.

When an MC68040 reports a write page fault, the stack frame contains the stacked PC of an instruction subsequent to the one that caused the write fault. On the MC68060, the stacked PC of the stack frame points to the instruction that caused the write page fault. This is a consequence of not having write-back slots on the stack frame.

11.1.2.2.4 PTEST, MOVEC of MMUSR, and PLPA. The PTEST instruction is unimplemented and an illegal instruction exception is encountered when this instruction is attempted. Existing MC68040 software must remove all references to the PTEST instruction. It is likely that this instruction resides in the access error handler when recovering from a page or descriptor fault. The PTEST instruction is not emulated in the M68060SP and must therefore be avoided.

The memory management unit status register (MMUSR) of the MC68040 is not implemented in the MC68060. If a MOVEC instruction is attempted to access this register, an ille-

gal instruction exception is taken. This instruction must be removed from existing MC68040 software since it is not emulated in the M68060SP.

The MC68060 compensates for the lack of these instructions by providing extensive information in the FSLW in the access error stack frame. In addition, a new instruction, PLPA, is added to translate a logical to physical address by initiating a table search. This instruction may be used to provide most of the function of the PTEST instruction. As with the PTEST instruction, PLPA loads the valid page descriptor into the ATC when the table search it initiates executes successfully.

If it is absolutely necessary to emulate the PTEST and the MOVEC of the MMUSR, Motorola provides assembly source code for these instructions in the bulletin board (see **C.5.4 AESOP Electronic Bulletin Board** for bulletin board details). The source code is provided as-is and is only a rough approximation of these instructions and may need customizing. No documentation is provided other than what is available in the source code.

11.1.2.3 CONTEXT SWITCH INTERRUPT HANDLERS. Context switch interrupt handlers that use the same virtual address to map into multiple physical address locations must flush the branch cache via the MOVEC to CACR instruction. The reason for this is that the branch cache is a logical cache and not a physical cache. For systems that transparently translate logical addresses to physical addresses, the branch cache need not be flushed.

In multiprocessor systems, care must be taken so that saved contexts generated by an MC68040-based node not be restored into an MC68060-based node, or vice-versa. The floating-point frames are different between an MC68040 and MC68060; incorrect swapping of contexts may cause format errors to be incurred.

If the context switch interrupt handler uses a nonmaskable interrupt (level 7), CAS (misaligned operands) or CAS2 instruction emulation may result in data corruption. There is no good workaround except by either avoid using the level 7 interrupt for context switching, or by using external hardware to block the interrupt lines from reporting an interrupt whenever LOCK is asserted.

11.1.2.4 TRACE HANDLERS. The MC68060 does not implement “trace on change of flow”. Debug software that rely on this feature must take this into consideration. When a change of flow trace encoding is encountered, the processor does not trace.

11.1.2.5 I/O DEVICE DRIVER SOFTWARE. The MC68060, like the MC68040, has a restart model, and device drivers that have been written for the MC68040 probably do not need any modification in device driver software when porting to the MC68060; however there are a few issues to consider.

The cache mode (CM) encoding on the TTRs and the page descriptors is different between the MC68060 and MC68040. The MC68060 executes reads and writes in strict program order, and therefore, whenever the CM bits indicate either a noncacheable precise or non-cacheable imprecise, the accesses are serialized. Areas that are marked cache-inhibited serialized for I/O devices should not be affected adversely by the cache mode change. Otherwise, the TTR format and the page descriptor formats have not changed for the MC68060.



Applications Information

I/O devices that normally incur bus errors need to be aware that the MC68060 has an imprecise exception mode that may need to be addressed.

11.1.3 Precise Vs. Imprecise Exception Mode

Systems that do not rely on the bus error (\overline{TEA} asserted) in normal operation are not affected much by the differences between the precise and imprecise exception mode.

The MC68060 provides the precise and imprecise exception modes to allow system software to assign the severity of bus errors (\overline{TEA} asserted) on write cycles. In general, bus errors on writes are recoverable in the precise exception mode, but not in the imprecise exception mode. The MC68040 provides a precise exception mode, but at the expense of performance and a large access error stack frame.

For systems that require precise bus error write cycles in a normal operating environment, it is possible to disable the store buffer via the MOVEC of CACR instruction. This impacts performance significantly, and must be carefully considered before doing so. Also, note that even with the store buffers disabled, a bus error caused by a push buffer write is still nonrecoverable.

11.1.4 Other Considerations

The following is a list of other concerns that are unlikely to affect system software, but are included for completeness.

1. Some of the exception priorities for multiple exceptions on the MC68060 are different than the MC68040 (see **Section 8 Exception Processing** for priority groupings). This shouldn't affect the way interrupts are handled, an interrupt is the lowest priority exception on both microprocessors.
2. Unlike the MC68040, the MC68060 provides only one snoop control signal, the snoop invalidate signal (\overline{SNOOP}). System software may need to CPUSH the cache before DMA activity is initiated. Alternatively, the cache mode may be changed to write-through cacheable for all shared memory areas.

11.2 USING AN MC68060 IN AN EXISTING MC68040 SYSTEM

This document outlines the issues involved in using an MC68060 in an existing MC68040 socket. It is assumed that for these applications, the MC68060 is made to operate in the half-speed bus mode.

11.2.1 Power Considerations

The MC68060 operates at a supply voltage of 3.3 V, not 5 V. The MC68060 interfaces gluelessly to transistor-transistor logic (TTL) levels. The following paragraphs discuss the two main issues of the lower, 3.3-V supply voltage.

11.2.1.1 DC TO DC VOLTAGE CONVERSION. The first issue involves the DC-to-DC voltage conversion for the MC68060 V_{dd} pins. The following paragraphs discuss two solutions to this problem.



11.2.1.1.1 Linear Voltage Regulator Solution. This solution uses a linear voltage regulator to supply 2 A at 3.3 V. This solution is inexpensive; however, conversion efficiency of only up to 65% can be achieved. Figure 11-1 shows a solution using power BJTs. This solution would be used primarily for applications that are cost sensitive, but not power sensitive. The suggested linear solution meets the 3.3 V \pm 5% MC68060 specifications.

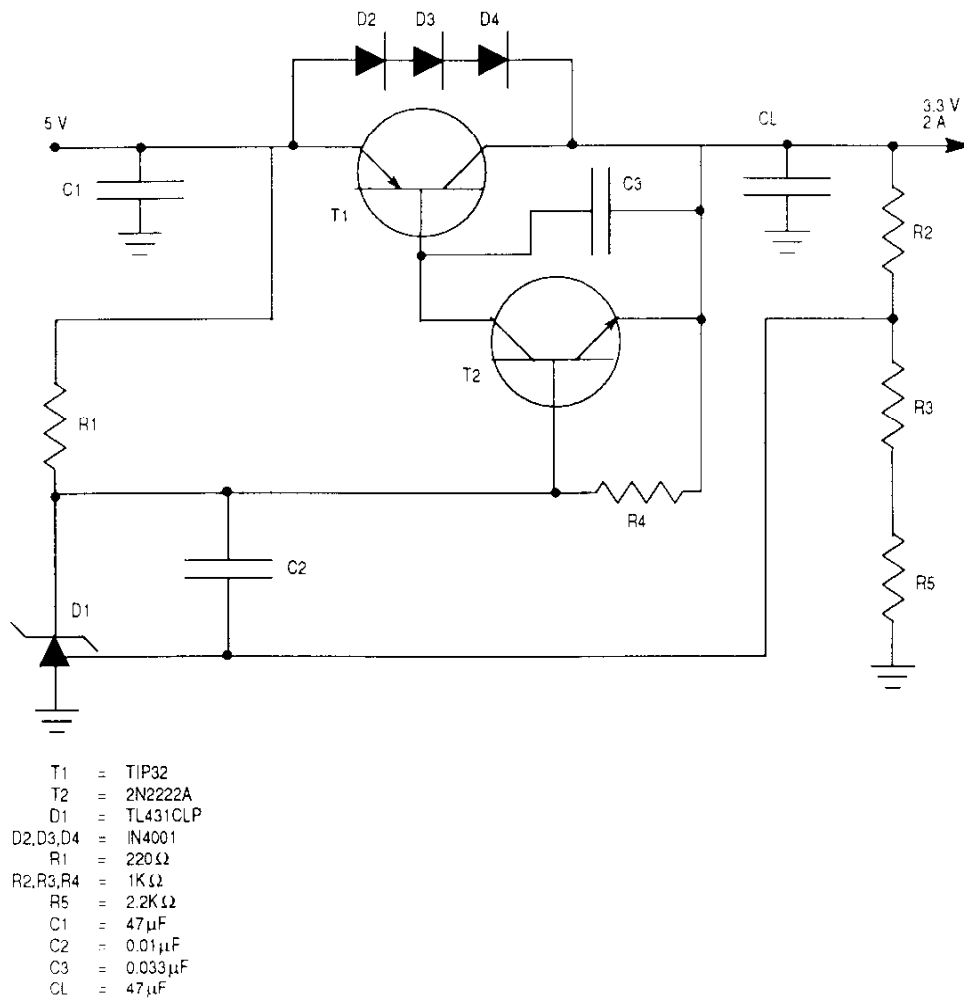

Figure 11-1. Linear Voltage Regulator Solution

11.2.1.1.2 Switching Regulator Solution. This solution uses switching regulators. Linear Technologies offers two parts, the LTC1147 and LTC1148 and MAXIM offers the MAX767. The main difference among these parts is a trade-off between price, part count, and conversion efficiency.

The LTC1147 solution is less expensive and has one fewer MOSFET than the LTC1148 solution. The LTC1148 is less than \$5 in 1000 piece quantities, and the LTC1147 is less than \$4 in 1000 piece quantities. In either of these solutions there are around 15 discrete

Applications Information

devices that are needed externally in addition to the Linear Technologies devices. The conversion efficiency is 89% and 93% for the LTC1147 and LTC1148, respectively. Figure 11-2 and Figure 11-3 show the solutions provided by using the switching regulators. The MAX767 provides over 90% conversion efficiency at less than \$4 in 1000 piece quantities. The MAX767 solution also requires discrete components off-chip. The MAX767 uses a smaller inductor than the LTC1148 solution. Figure 11-4 shows a MAXIM voltage regulator solutions. All the suggested solutions meets 3.3 V \pm 5% MC68060 specifications.

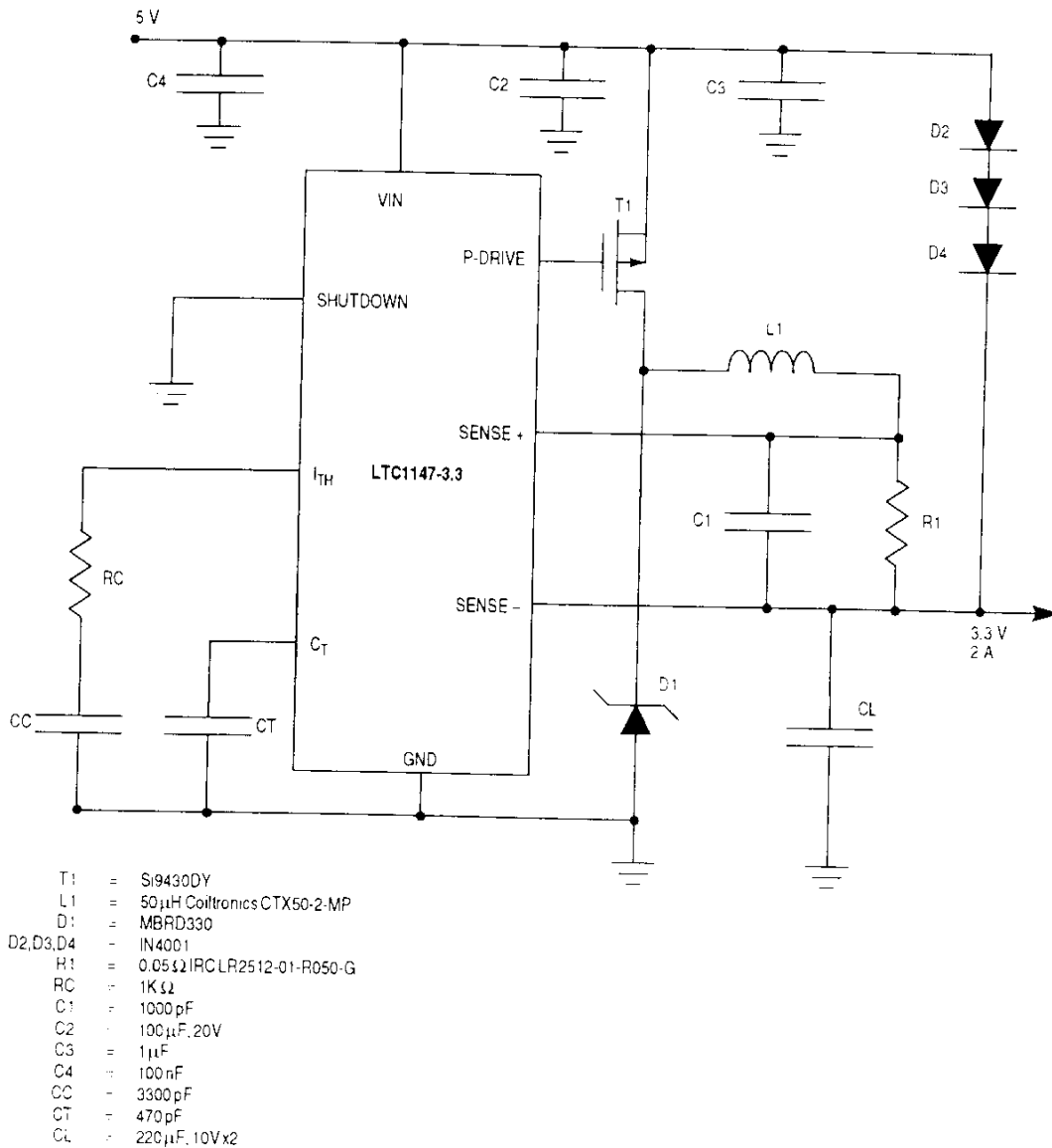

Figure 11-2. LTC1147 Voltage Regulator Solution

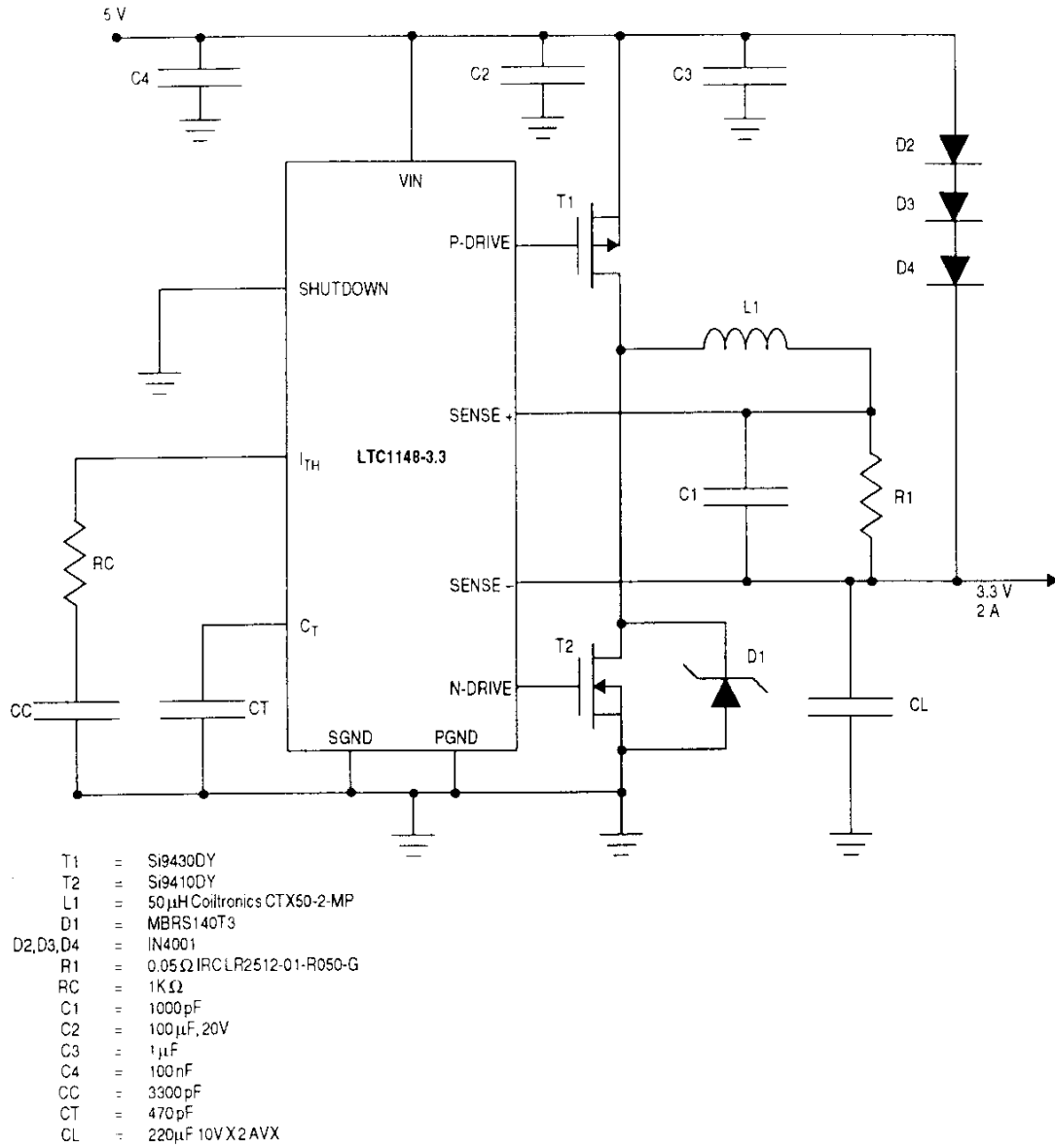
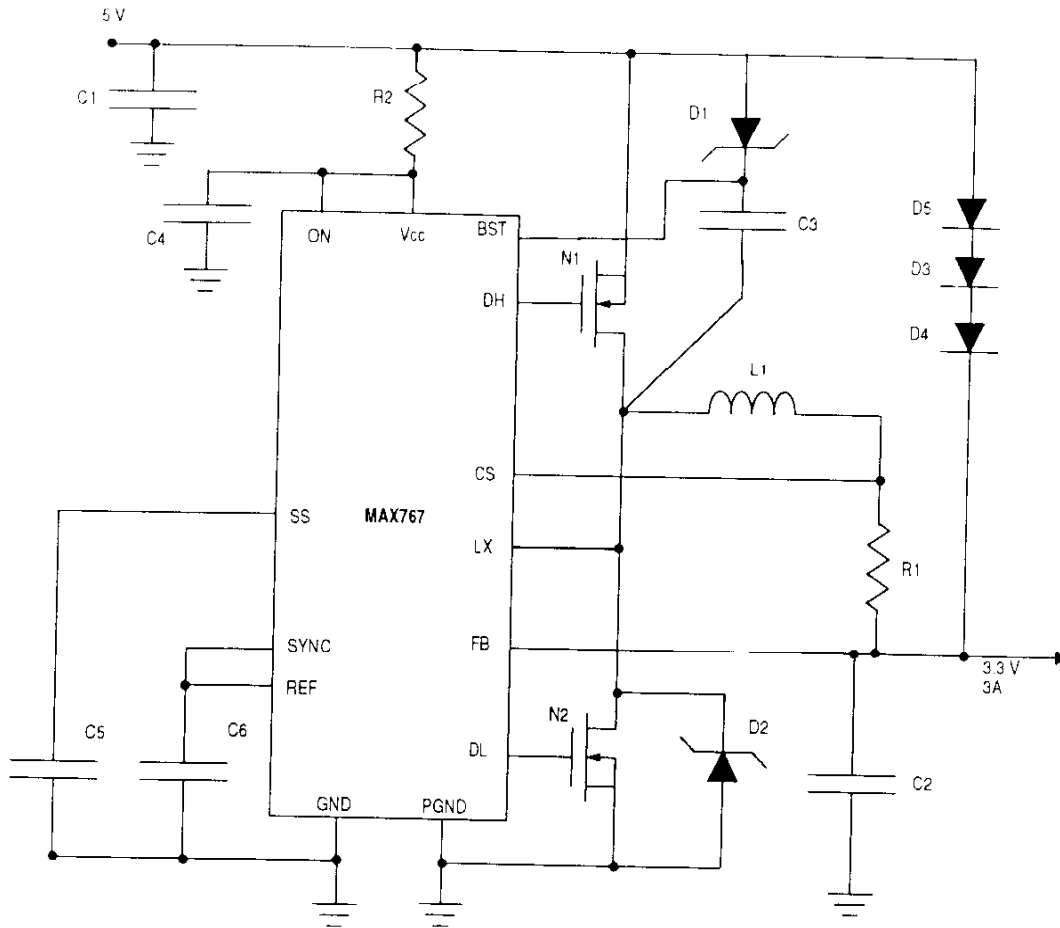

Figure 11-3. LTC1148 Voltage Regulator Solution

Applications Information



- R1 = .02Ω IRLR2010-01-R020
- R2 = 10Ω
- N1,N2 = Motorola MMDF3N03HD
- D1 = Central Semi. CMPSM-3
- D2 = Motorola MBRS120T3
- C1 = 2x 47μF, 20V AVXTPSD476K020R
- C2 = 2x 150μF Sprague 595D157X0010D7T
- C3 = 0.1μF
- C4 = 4.7μF
- D3,D4,D5 = 1N4001
- L1 = 5.0μH Sumida CDR125 DRG#4722-JPS-001

Figure 11-4. MAX767 Voltage Regulator Solution

11.2.1.2 INPUT SIGNALS DURING POWER-UP REQUIREMENT. The second issue involves the requirement that during power-up, input signals to the MC68060 not exceed V_{dd} by more than 4 V. This is achieved by ensuring that the 5-V supply not exceed the 3.3-V supply by more than 4 V. In any of the previously discussed DC-to-DC conversion solutions, it is possible to add three diodes in series from the 5-V supply to the 3.3-V plane. During power-up, the diodes forward bias and thus provide a current path between the 5-V source and the 3.3-V plane. This solution provides no more than $(0.7 * 3) = 2.1$ V drop between the 5-V input and the 3.3-V plane. When the voltage regulator stabilizes, the difference of $(5 - 3.3) = 1.7$ V is insufficient to forward bias the three diodes, hence not dissipating any energy. Both Motorola and Linear Technologies have indicated that the three diode shunt does not adversely affect operation.

Figure 11-1, Figure 11-2, and Figure 11-3 include the shunt diodes as proposed to keep the 5-V supply from drifting more than 2.5 V from the 3.3-V plane.

11.2.2 Output Hold Time Differences

On the MC68040, outputs are driven off the falling edge of PCLK. Since the MC68060 drives everything off the rising edge of CLK, a hold time differential exists and is discussed in the following paragraphs.

The data write hold time specification may be met by using the extra data hold time mode to extend the hold time by a full CLK cycle in which \overline{CLKEN} is asserted. However, using this mode requires that the \overline{IPLx} signals be modified to invoke configuration of this mode at reset.

Decreasing the address hold time affects primarily systems containing slow peripherals. An example of this problem can be shown on a system that does a read of the MC68681 duart peripheral. If the system design is implemented such that on a read of the MC68681, the address hold time relative to chip select specification is violated, it is possible to internally confuse the MC68681 and cause it to enter its test mode. The MC68681 is one of many devices that require addresses to be stable as long as its chip select is asserted. Figure 11-5 and Figure 11-6 show the differences between the hold time for the MC68060 the MC68040.

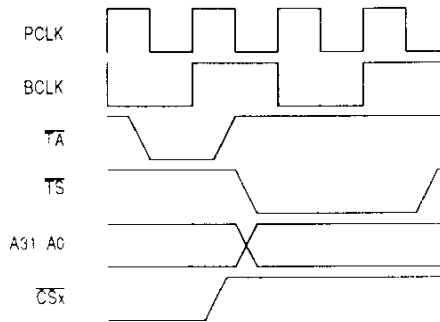

Figure 11-5. MC68040 Address Hold Time

Applications Information

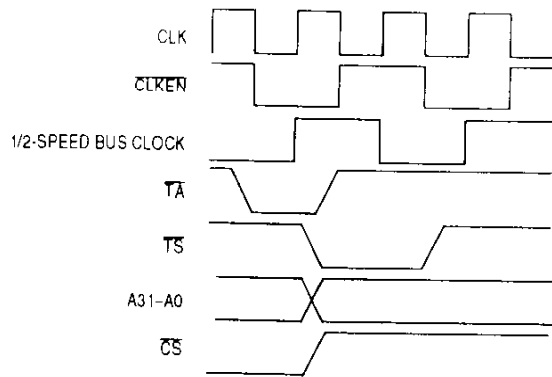

Figure 11-6. MC68060 Address Hold Time

A possible solution addressing both the address and write data hold time issue for slow peripherals is to force at least one dead state between \overline{TA} negation and \overline{TS} assertion of the next bus cycle. This can be achieved by arbitrating the bus away from the processor on any long-word, word, or byte access. This forces the processor to release the bus, not begin a new bus cycle, three-state the address bus, and three-state the data bus on write cycles. Since the address and data buses (on writes) are three-stated and not directly driven by the MC68060, output hold time in this solution relies on the capacitive loading of the bus to achieve the extended hold time.

Once the dead state has been added, the bus is returned to the processor and normal operation continues. This suggested solution does not affect line (burst) accesses, which are typically cacheable and contain no I/O devices. For this reason, performance is not compromised. In this implementation, the only signal that may be affected is \overline{BG} . In this solution, \overline{BG} is intercepted and combined with the dead-state inserting logic. This combined signal is then fed into the MC68060's \overline{BG} . Figure 11-7 shows the effect of \overline{BG} .

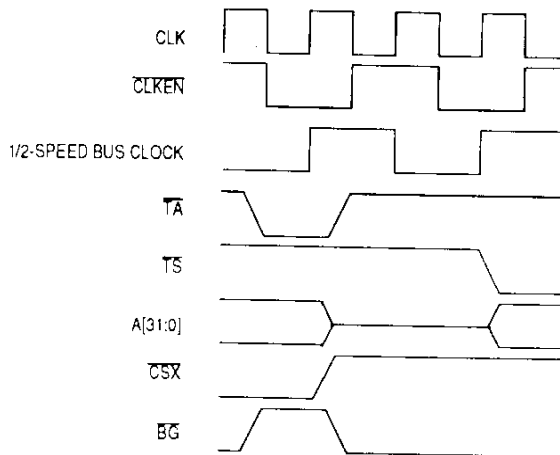

Figure 11-7. MC68060 Address Hold Time Fix

11.2.3 Bus Arbitration

The MC68060 does not drive the bus in implicit bus ownership cases where it has not yet requested the bus. Although this feature is not known to be necessary for MC68040-based designs, this is a difference. This MC68060 action does not pose any known problems to existing MC68040 designs.

The $\overline{\text{BGR}}$ signal may be pulled low or grounded to cause the MC68060 to relinquish the bus on locked sequences to behave like the MC68040. To use the $\overline{\text{BB}}$ protocol, $\overline{\text{BTT}}$ should be pulled up through a resistor (approximate value of 5 K Ω) to V_{dd} . Since the MC68060 drives $\overline{\text{BTT}}$ low at times, no other signals should be connected to this pullup resistor.

See **11.2.2 Output Hold Time Differences**, as bus arbitration may be an issue for output hold time requirements.

11.2.4 Snooping

The MC68060 does not support snoop intervention during bus cycles as the MC68040 does. The MC68060 implements only the snoop invalidate protocol. The MC68060 only has one $\overline{\text{SNOOP}}$ signal instead of the two-bit encoding of the SCx signals on the MC68040. Also, the MC68060 does not implement the $\overline{\text{MI}}$ pin; the $\overline{\text{MI}}$ signal must be pulled up if it is used by the system.

If an MC68040 system only utilizes invalidate line snoop functionality, the SCx signal control could be mapped to assert $\overline{\text{SNOOP}}$ to the MC68060. Other MC68040 snoop implementations must also implement software changes to flush cache or address map to write-through mode shared system memory areas.

11.2.5 Special Modes

The MC68040 and MC68060 $\overline{\text{IPLx}}$ signals have different functionality when coming out of reset. On the MC68040, the $\overline{\text{IPLx}}$ signals select the buffer size. The MC68060 has only one buffer size, and therefore the MC68060 encodes different functionality when it samples the $\overline{\text{IPLx}}$ signals when coming out of reset.

The MC68060 has new special modes that are selectable via the $\overline{\text{IPLx}}$ signals during reset. These MC68060 special modes are: acknowledge termination ignore state capability, acknowledge termination mode, and extra write hold mode. To prevent these modes from being enabled, the $\overline{\text{IPLx}}$ signals must be negated (pulled high) during reset.

The MC68060 does not implement the DLE functionality of the MC68040. Applications that use the DLE mode are not upgradable without using external logic. The MC68060 does not implement the muxed bus functionality of the MC68040. Applications that use muxed bus mode are not upgradable without using external logic.

Applications Information

11.2.6 Clocking

For systems which have PCLK-to-BCLK skew controlled by a phase-locked-loop (PLL) clock generator such as the 88915 or 88916, it is possible to connect the PCLK of the MC68040 to the MC68060 CLK input as shown in Figure 11-8. Otherwise, the MC68060 CLK must be generated by an 88915 PLL as shown in Figure 11-9.

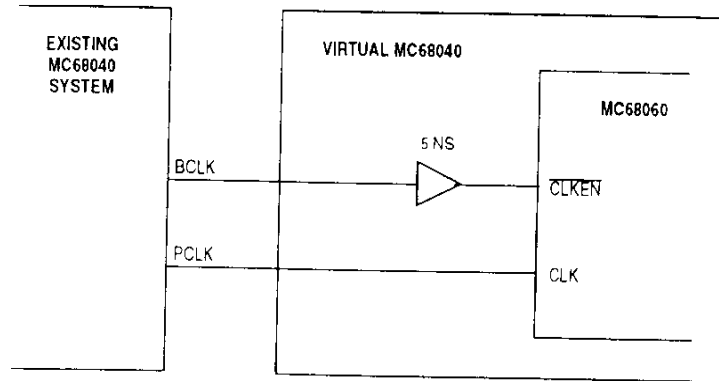

Figure 11-8. Simple CLK Generation

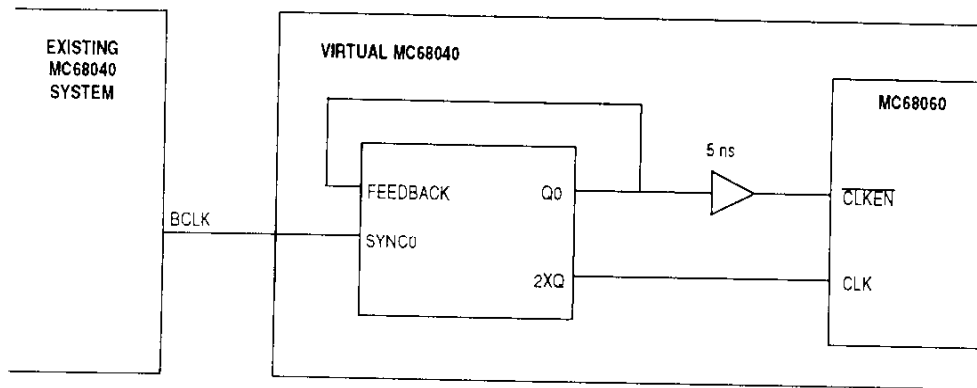

Figure 11-9. Generic CLK Generation

Appropriate generation of the $\overline{\text{CLKEN}}$ signal to enable 1/2-speed operation is easily achieved by delaying the MC68040 BCLK by 5 ns before feeding it into the $\overline{\text{CLKEN}}$ input of the MC68060.

Be aware that a clock skew exists between CLK and BCLK. The MC88915 can only control the skew to within 1 ns. Figure 11-10 shows the relationship between BCLK and $\overline{\text{CLKEN}}$.

11.2.7 PSTx Encoding

PSTx signal encoding is different between the MC68060 and MC68040. This should not affect normal applications because PSTx signals are not used for bus control logic.



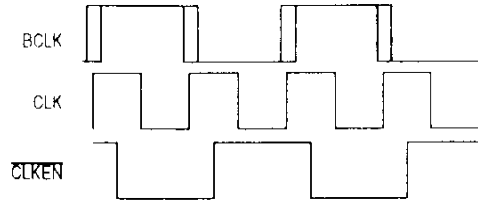

Figure 11-10. MC68040 BCLK to $\overline{\text{CLKEN}}$ Relationship

11.2.8 Miscellaneous Pullup Resistors

Pullup $\overline{\text{CLA}}$ to prevent the A3 and A2 address lines from cycling on burst accesses. Pullup $\overline{\text{TRA}}$ when MC68040 acknowledge termination mode is being used.

11.3 EXAMPLE DRAM ACCESS

When interfacing the MC68060 with dynamic random access memory (DRAM), it is necessary to determine how many clocks per bus cycle will be needed for a line burst transfer. The number of clocks per bus cycle is dependent upon the processor clock frequency and the DRAM access times. In this example, the DRAM $\overline{\text{RAS}}$ access time, $\overline{\text{CAS}}$ access time, $\overline{\text{RAS}}$ precharge time, and $\overline{\text{CAS}}$ precharge time are used to determine the number of clocks per bus cycle of a DRAM access. Figure 11-11 shows two successive line burst transfers. The $\overline{\text{CLA}}$ signal is used to cycle A3 and A2 a clock before the DRAM subsystem asserts $\overline{\text{TA}}$.

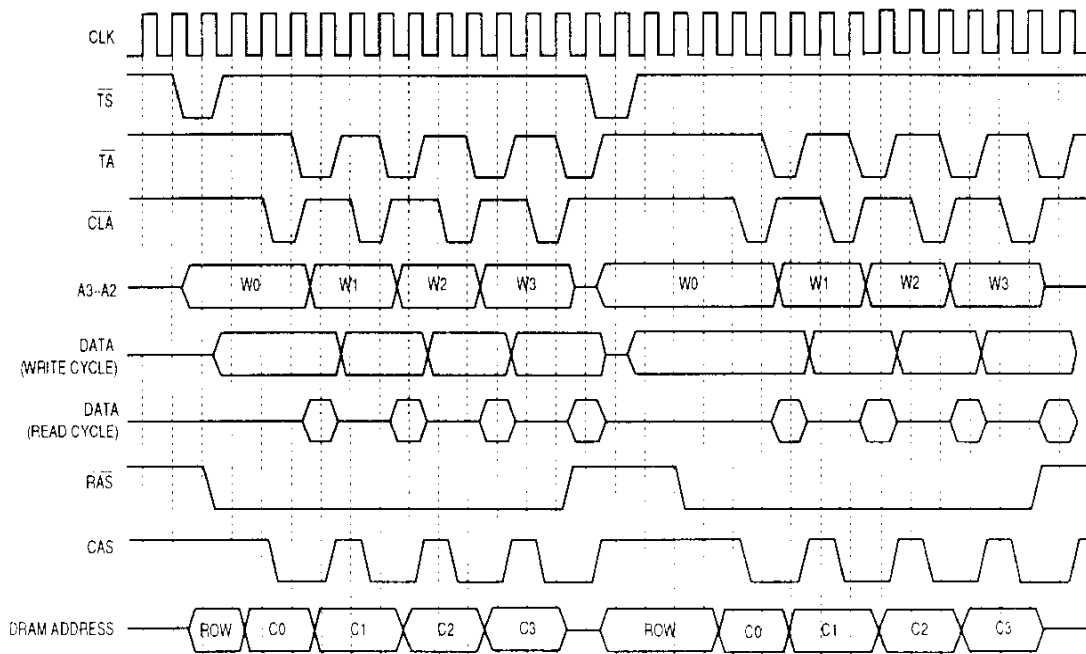

Figure 11-11. DRAM Timing Analysis

Applications Information

The \overline{RAS} access time determines the number of wait states needed for the first memory access. The \overline{RAS} access time is the time it takes between \overline{RAS} being asserted and valid data coming out of the DRAM. The total available time for the first access is the time between the \overline{TS} assertion and the first \overline{TA} assertion. This time is equal to the clock period multiplied by the number of primary wait states. In addition to the \overline{RAS} access time, the MC68060 input setup time and the \overline{TS} to \overline{RAS} propagation delay must also occur between the \overline{TS} and \overline{TA} signals. The following equation represents the number of wait states required for the primary memory access:

$$\text{Wait States} = (\overline{RAS} \text{ propagation delay} + \overline{RAS} \text{ access time} + \text{Input Setup Time}) / \text{clock period}$$

The following example assumes a \overline{RAS} access time of 65 ns, an input setup time of 7 ns, and a \overline{RAS} propagation delay of 5 ns. The processor is running at 50 MHz, so the clock period is 20 ns. The number of wait states required is $(5\text{ns} + 65\text{ns} + 7\text{ns}) / 20\text{ns} = 3.85$ wait states. Therefore 4 wait states are required.

The \overline{CAS} access time and the \overline{CAS} precharge time determines the number of secondary wait states required. The \overline{CAS} precharge time is the time that the \overline{CAS} signal must remain negated between assertions. The total time available for the secondary access is the time between the first and second \overline{TA} signals. This time is equal to the clock period multiplied by the number of secondary wait states. Since \overline{CAS} must toggle during this time, two \overline{CAS} propagation delays, the \overline{CAS} precharge time, the \overline{CAS} access time, and the MC68060 input setup time must occur during this time. Typically, the \overline{CAS} precharge time is less than a clock period. Therefore an entire clock period is used to toggle \overline{CAS} . This leaves one \overline{CAS} propagation delay time, a \overline{CAS} access time, and the input setup time. This time must be less than the number of wait states less one multiplied by the clock period. The following equation represents the number of wait states required for the secondary memory accesses:

$$\text{Wait States} = [(\overline{CAS} \text{ propagation delay} + \overline{CAS} \text{ access time} + \text{input setup time}) / \text{clock period}] + 1$$

The following example assumes a \overline{CAS} access time of 20 ns, input setup time of 7 ns, and a \overline{CAS} propagation delay of 5 ns. The clock period is 20 ns. The number of wait states required is $[(5\text{ns} + 20\text{ns} + 7\text{ns}) / 20\text{ns}] + 1 = 2.6$. Therefore three wait states are required. This first line burst transfer is a 5:3:3:3 transfer. For the primary transfer, an extra clock is added for the \overline{TS} signal assertion.

In this example, a second line burst transfer occurs immediately following the first transfer. If the same DRAM chips are being accessed, \overline{RAS} precharge time must be considered. \overline{RAS} precharge time is the time that the \overline{RAS} signal must remain high between assertions. In the example, \overline{RAS} precharge time is 65 ns. Two additional wait states need to be added after the second \overline{TS} to assure that the \overline{RAS} precharge time is satisfied. Therefore, the second line burst transfer is a 7:3:3:3 transfer.

11.4 THERMAL MANAGEMENT

The maximum case temperature (T_c) in °C can be obtained from the following equation:

$$T_c = T_j - P_d \times \theta_{jc}$$

where:

- T_c = Maximum Case Temperature
- T_j = Maximum Junction Temperature
- P_d = Maximum Power Dissipation of the Device
- θ_{jc} = Thermal Resistance between the Junction of the Die and the Case

In general, the ambient temperature (T_a) in °C is a function of the following equation:

$$T_a = T_j - P_d \times \theta_{jc} - P_d \times \theta_{ca}$$

The thermal resistance from case to outside ambient (θ_{ca}) is the only user-dependent parameter once a buffer output configuration has been determined. Reducing the case to ambient thermal resistance increases the maximum operating ambient temperature. Therefore, by utilizing methods such as heat sinks and ambient air cooling to minimize θ_{ca} , a higher ambient operating temperature and/or a lower junction temperature can be achieved. However, an easier approach to thermal evaluation uses the following equations:

$$T_a = T_j - P_d \times \theta_{ja} \quad \text{or}$$

$$T_j = T_a + P_d \times \theta_{ja}$$

where:

$$\theta_{ja} = \text{Thermal Resistance from the Junction to the Ambient } (\theta_{jc} + \theta_{ca})$$

The total thermal resistance for a package (θ_{ja}) is a combination of its two components, θ_{jc} and θ_{ca} . These components represent the barrier to heat flow from the semiconductor junction to the package case surface (θ_{jc}) and θ_{ca} . Although θ_{jc} is package related and the user cannot influence it, θ_{ca} is user dependent. Good thermal management by the user, such as heat sink and airflow, can significantly reduce θ_{ca} achieving either a lower semiconductor junction temperature or a higher ambient operating temperature. The following tables can be used to aid in deciding how much of air flow and heat sink for proper thermal management.

Data for the “no heat sink” cases are derived from MC68040 PGA package characteristics. The MC68060 PGA package has similar thermal characteristics as the MC68060 PGA Package. The heat sink used for the “with heat sink” cases are based on the Thermalloy 2333B heat sink. Since exact power dissipation figures for the MC68060 are unavailable at the time of printing, linear interpolation of these tables can be used to provide rough estimates. Table 11-1, Table 11-2, and Table 11-3 list the thermal data.



Applications Information

Table 11-1. With Heat Sink, No Air Flow

Air Flow Velocity	P _D	T _J	θ _{JC} MAX	T _A - T _C	T _C	T _A
0 LFM	2.8 W	110 °C	2.5 °C/W	35 °C	103 °C	68 °C
0 LFM	3.1 W	110 °C	2.5 °C/W	38 °C	102 °C	64 °C
0 LFM	3.5 W	110 °C	2.5 °C/W	40 °C	101 °C	61 °C
0 LFM	3.8 W	110 °C	2.5 °C/W	43 °C	100 °C	57 °C
0 LFM	4.2 W	110 °C	2.5 °C/W	45 °C	100 °C	54 °C
0 LFM	4.5 W	110 °C	2.5 °C/W	48 °C	99 °C	51 °C
0 LFM	4.9 W	110 °C	2.5 °C/W	50 °C	98 °C	48 °C
0 LFM	5.2 W	110 °C	2.5 °C/W	53 °C	97 °C	44 °C

Table 11-2. With Heat Sink, with Air Flow

Air Flow Velocity	P _D	T _J	θ _{JC} MAX	θ _{CA}	θ _{JA}	T _C	T _A
200 LFM	2.8 W	110 °C	2.5 °C/W	4.25 °C/W	6.75 °C/W	103 °C	91 °C
200 LFM	3.1 W	110 °C	2.5 °C/W	4.25 °C/W	6.75 °C/W	102 °C	89 °C
200 LFM	3.5 W	110 °C	2.5 °C/W	4.25 °C/W	6.75 °C/W	101 °C	87 °C
200 LFM	3.8 W	110 °C	2.5 °C/W	4.25 °C/W	6.75 °C/W	100 °C	84 °C
200 LFM	4.2 W	110 °C	2.5 °C/W	4.25 °C/W	6.75 °C/W	100 °C	82 °C
200 LFM	4.5 W	110 °C	2.5 °C/W	4.25 °C/W	6.75 °C/W	99 °C	80 °C
200 LFM	4.9 W	110 °C	2.5 °C/W	4.25 °C/W	6.75 °C/W	98 °C	77 °C
200 LFM	5.2 W	110 °C	2.5 °C/W	4.25 °C/W	6.75 °C/W	97 °C	75 °C
400 LFM	2.8 W	110 °C	2.5 °C/W	2.25 °C/W	4.75 °C/W	103 °C	97 °C
400 LFM	3.1 W	110 °C	2.5 °C/W	2.25 °C/W	4.75 °C/W	102 °C	95 °C
400 LFM	3.5 W	110 °C	2.5 °C/W	2.25 °C/W	4.75 °C/W	101 °C	94 °C
400 LFM	3.8 W	110 °C	2.5 °C/W	2.25 °C/W	4.75 °C/W	100 °C	92 °C
400 LFM	4.2 W	110 °C	2.5 °C/W	2.25 °C/W	4.75 °C/W	100 °C	90 °C
400 LFM	4.5 W	110 °C	2.5 °C/W	2.25 °C/W	4.75 °C/W	99 °C	89 °C
400 LFM	4.9 W	110 °C	2.5 °C/W	2.25 °C/W	4.75 °C/W	98 °C	87 °C
400 LFM	5.2 W	110 °C	2.5 °C/W	2.25 °C/W	4.75 °C/W	97 °C	85 °C
600 LFM	2.8 W	110 °C	2.5 °C/W	1.50 °C/W	4.00 °C/W	103 °C	99 °C
600 LFM	3.1 W	110 °C	2.5 °C/W	1.50 °C/W	4.00 °C/W	102 °C	98 °C
600 LFM	3.5 W	110 °C	2.5 °C/W	1.50 °C/W	4.00 °C/W	101 °C	96 °C
600 LFM	3.8 W	110 °C	2.5 °C/W	1.50 °C/W	4.00 °C/W	100 °C	95 °C
600 LFM	4.2 W	110 °C	2.5 °C/W	1.50 °C/W	4.00 °C/W	100 °C	93 °C
600 LFM	4.5 W	110 °C	2.5 °C/W	1.50 °C/W	4.00 °C/W	99 °C	92 °C
600 LFM	4.9 W	110 °C	2.5 °C/W	1.50 °C/W	4.00 °C/W	98 °C	91 °C
600 LFM	5.2 W	110 °C	2.5 °C/W	1.50 °C/W	4.00 °C/W	97 °C	89 °C

Table 11-3. No Heat Sink

Air Flow Velocity	P _D	T _J	θ _{JC} MAX	θ _{CA}	θ _{JA}	T _C	T _A
0 LFM	2.8 W	110 °C	2.5 °C/W	20 °C/W	23 °C/W	103 °C	48 °C
0 LFM	3.1 W	110 °C	2.5 °C/W	20 °C/W	23 °C/W	102 °C	40 °C
0 LFM	3.5 W	110 °C	2.5 °C/W	20 °C/W	23 °C/W	101 °C	32 °C
0 LFM	3.8 W	110 °C	2.5 °C/W	20 °C/W	23 °C/W	100 °C	24 °C
0 LFM	4.2 W	110 °C	2.5 °C/W	20 °C/W	23 °C/W	100 °C	16 °C
0 LFM	4.5 W	110 °C	2.5 °C/W	20 °C/W	23 °C/W	99 °C	9 °C
0 LFM	4.9 W	110 °C	2.5 °C/W	20 °C/W	23 °C/W	98 °C	1 °C
0 LFM	5.2 W	110 °C	2.5 °C/W	20 °C/W	23 °C/W	97 °C	-7 °C
200 LFM	2.8 W	110 °C	2.5 °C/W	13 °C/W	16 °C/W	103 °C	68 °C
200 LFM	3.1 W	110 °C	2.5 °C/W	13 °C/W	16 °C/W	102 °C	63 °C
200 LFM	3.5 W	110 °C	2.5 °C/W	13 °C/W	16 °C/W	101 °C	58 °C
200 LFM	3.8 W	110 °C	2.5 °C/W	13 °C/W	16 °C/W	100 °C	53 °C
200 LFM	4.2 W	110 °C	2.5 °C/W	13 °C/W	16 °C/W	100 °C	48 °C
200 LFM	4.5 W	110 °C	2.5 °C/W	13 °C/W	16 °C/W	99 °C	42 °C
200 LFM	4.9 W	110 °C	2.5 °C/W	13 °C/W	16 °C/W	98 °C	37 °C
200 LFM	5.2 W	110 °C	2.5 °C/W	13 °C/W	16 °C/W	97 °C	32 °C
400 LFM	2.8 W	110 °C	2.5 °C/W	10 °C/W	13 °C/W	103 °C	77 °C
400 LFM	3.1 W	110 °C	2.5 °C/W	10 °C/W	13 °C/W	102 °C	73 °C
400 LFM	3.5 W	110 °C	2.5 °C/W	10 °C/W	13 °C/W	101 °C	68 °C
400 LFM	3.8 W	110 °C	2.5 °C/W	10 °C/W	13 °C/W	100 °C	64 °C
400 LFM	4.2 W	110 °C	2.5 °C/W	10 °C/W	13 °C/W	100 °C	60 °C
400 LFM	4.5 W	110 °C	2.5 °C/W	10 °C/W	13 °C/W	99 °C	56 °C
400 LFM	4.9 W	110 °C	2.5 °C/W	10 °C/W	13 °C/W	98 °C	52 °C
400 LFM	5.2 W	110 °C	2.5 °C/W	10 °C/W	13 °C/W	97 °C	48 °C
600 LFM	2.8 W	110 °C	2.5 °C/W	8 °C/W	11 °C/W	103 °C	81 °C
600 LFM	3.1 W	110 °C	2.5 °C/W	8 °C/W	11 °C/W	102 °C	77 °C
600 LFM	3.5 W	110 °C	2.5 °C/W	8 °C/W	11 °C/W	101 °C	74 °C
600 LFM	3.8 W	110 °C	2.5 °C/W	8 °C/W	11 °C/W	100 °C	70 °C
600 LFM	4.2 W	110 °C	2.5 °C/W	8 °C/W	11 °C/W	100 °C	66 °C
600 LFM	4.5 W	110 °C	2.5 °C/W	8 °C/W	11 °C/W	99 °C	63 °C
600 LFM	4.9 W	110 °C	2.5 °C/W	8 °C/W	11 °C/W	98 °C	59 °C
600 LFM	5.2 W	110 °C	2.5 °C/W	8 °C/W	11 °C/W	97 °C	55 °C

Applications Information

11.5 SUPPORT DEVICES

Table 11-4 outlines miscellaneous devices available that can be used with the MC68060.

Table 11-4. Support Devices and Products

Device	Description	Literature
MC88926	3.3 Volt Clock Driver with PLL	BR1333/D
MC88915/916	Clock Drivers with PLL	BR1333/D
MCM62940	SRAM with Burst Capability	DL113
MC68150	Dynamic Bus Sizing for the MC68040	MC68150/D
MC68360	Peripherals, DRAM controller when used in the companion mode	MC68360/D
Diodes/Transistors	Linear Devices	DL128
SRAMS	Static Memory	DL113
DRAMS	Dynamic Memory	DL113
NM27P6841	EPROM with Burst Capability	Contact National Semiconductor
MAX767	Switching Voltage Regulator	Contact Maxim Integrated Products
LTC1147/1148	Switching Voltage Regulator	Contact Linear Technologies
Bus Adapter	MC68060 to MC68040 PGA to PGA Bus Adapter	Contact Interconnect Systems Inc.

SECTION 12 ELECTRICAL AND THERMAL CHARACTERISTICS

The following paragraphs provide information on the maximum rating and thermal characteristics for the MC68060. This section is subject to change. For the most recent specifications, contact the AESOP electronic bulletin board at (800)843-3451 or (512)891-3650 (refer to **C.5.4 AESOP Electronic Bulletin Board** for connection information).

12.1 MAXIMUM RATINGS

Characteristic	Symbol	Value	Unit
Supply Voltage	V_{CC}	-0.3 to 4.0	V
Input Voltage	V_{in}	-0.5 to $V_{CC}+4$	V
Maximum Operating Junction Temperature	T_J	110	°C
Minimum Operating Ambient Temperature	T_A	0	°C
Storage Temperature Range	T_{stg}	-55 to 150	°C

This device contains protective circuitry against damage due to high static voltages or electrical fields; however, it is advised that normal precautions be taken to avoid application of any voltages higher than maximum-rated voltages to this high-impedance circuit. Reliability of operation is enhanced if unused inputs are tied to an appropriate logic voltage level (e.g., either GND or V_{CC}).

12.2 THERMAL CHARACTERISTICS

Description	Symbol	Value	Unit
Thermal Resistance, Junction to Case—PGA	θ_{JC}	2.5	°C/W
Thermal Resistance, Junction to Case—CQFP	θ_{JC}	2.0	°C/W

12.3 POWER DISSIPATION

Conditions	MC68EC060			MC68LC060		MC68060		Unit
	40 MHz	50 MHz	66 MHz	50 MHz	66 MHz	50 MHz	66 MHz	
$V_{CC} = 3.465$ V, $T_A = 0^\circ$ C Normal Mode	3.1	3.5	4.5	3.5	4.5	3.9	4.9	W
$V_{CC} = 3.465$ V, $T_A = 0^\circ$ C LPSTOP Mode, CLK Running	300	300	300	300	300	300	300	mW
$V_{CC} = 3.465$ V, $T_A = 0^\circ$ C LPSTOP Mode, CLK Stopped Low	30	30	30	30	30	30	30	mW

NOTES:

1. Power dissipation values are preliminary and will likely be replaced with lower values upon further testing.
2. Power dissipation assumes no DC load.
3. Power dissipation figures are not applicable to the debug pipe control mode.

Electrical and Thermal Characteristics

12.4 DC ELECTRICAL SPECIFICATIONS ($V_{CC} = 3.3 V_{DC} \pm 5\%$)

Characteristic	Symbol	Min	Max	Unit
Input High Voltage	V_{IH}	2	5.5	V
Input Low Voltage	V_{IL}	GND	0.8	V
Undershoot	—	—	0.8	V
Overshoot	—	—	0.8	V
Input Leakage Current AVEC, CLK, TT1, BG, CDIS, MDIS, IPLx, RSTI, SNOOP, CLKEN, TBI, TCI, TCK, TEA, TA, TRA, BGR, CLA, JTAG	I_{IL}, I_{IH}	-50	20	μA
Hi-Z (Off-State) Leakage Current An, BB, CIOU, Dn, LOCK, LOCKE, TDO, TIP, SAS, BTT, BSx, TMx, TLNx, TS, TTx, UPAx	I_{TSI}	-50	20	μA
Signal Low Input Current, $V_{IL} = 0.8 V$ TMS, TDI, TRST	I_{IL}	-1.1	-0.18	mA
Signal High Input Current, $V_{IH} = 2.0 V$ TMS, TDI, TRST	I_{IH}	-0.94	-0.16	mA
Output High Voltage, $I_{OH} = 16 mA$	V_{OH}	2.4	—	V
Output Low Voltage, $I_{OL} = 16 mA$	V_{OL}	—	0.5	V
Capacitance*, $V_{in} = 0 V, f = 1 MHz, CLK$ Only	C_{in}	—	20	pF
Capacitance*, $V_{in} = 0 V, f = 1 MHz, All$ Inputs Except CLK	C_{in}	—	20	pF

*Capacitance is periodically sampled and not 100% tested.

12.5 CLOCK INPUT SPECIFICATIONS ($V_{CC} = 3.3 V_{DC} \pm 5\%$)

Num	Characteristic	40 MHz ¹		50 MHz		66 MHz		Unit
		Min	Max	Min	Max	Min	Max	
	Frequency of Operation	0 ⁴	40	0 ⁴	50	0 ⁴	66.67	MHz
1	CLK Cycle Time	25	—	20	—	15	—	ns
2	CLK Rise Time	—	2	—	2	—	2	ns
3	CLK Fall Time	—	2	—	2	—	2	ns
4	CLK Duty Cycle Measured at 1.5 V	45	55	45	55	45	55	%
4a ²	CLK Pulse Width High Measured at 1.5 V	11.25	13.75	9	11	6.75	8.25	ns
4b ²	CLK Pulse Width Low Measured at 1.5 V	11.25	13.75	9	11	6.75	8.25	ns
55	CLKEN Input Setup	8	—	7	—	5	—	ns
56	CLKEN Input Hold	2	—	2	—	2	—	ns

NOTES:

1. 40 MHz available only for the MC68EC060.
2. Specification value at maximum frequency of operation.
3. CLK may be stopped LOW to conserve power.
4. Minimum frequency is periodically sampled and not 100% tested.

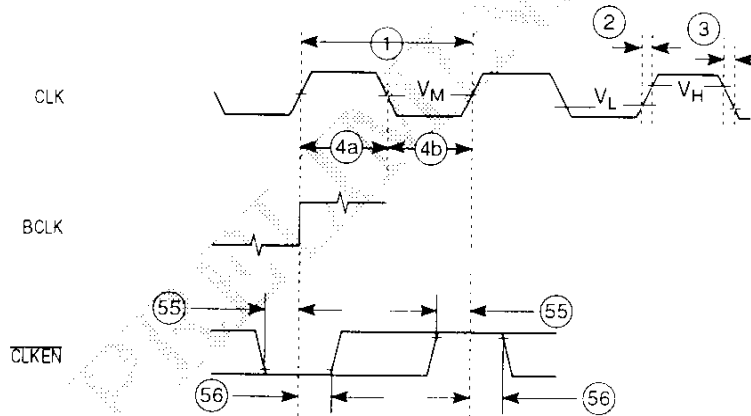

Figure 12-12. Clock Input Timing Diagram

Electrical and Thermal Characteristics

12.6 OUTPUT AC TIMING SPECIFICATIONS ($V_{CC} = 3.3 V_{DC} \pm 5\%$)

Num	Characteristic	40 MHz ¹				50 MHz				66 MHz				Unit
		Pad Starts at 5.5 V ³		Pad Starts at V _{CC} ³		Pad Starts at 5.5 V ³		Pad Starts at V _{CC} ³		Pad Starts at 5.5 V ³		Pad Starts at V _{CC} ³		
		Min	Max	Min	Max	Min	Max	Min	Max	Min	Max	Min	Max	
11 ⁵	BCLK to Address C _I OUT, LOCK, LOCKE, R/W, SIZx, TLN, TMx, TTx, UP _{Ax} , BSx Valid (signal pre-driven)	—	—	3	17	—	—	3	12.6	—	—	3	9.9	ns
11a ⁵	BCLK to Address C _I OUT, LOCK, LOCKE, R/W, SIZx, TLN, TMx, TTx, UP _{Ax} , BSx Valid (Signal from three state)	3	19	3	18	3	15.4	3	13.5	3	11.8	3	10.4	ns
12	BCLK or CLK to Output Invalid (Output Hold)	3	—	3	—	3	—	3	—	3	—	3	—	ns
13	BCLK to TS Valid	3	19	3	18	3	14.4	3	12.3	3	10.9	3	9.5	ns
14	BCLK to TIP Valid	3	19	3	18	3	15.4	3	13.5	3	11.8	3	10.4	ns
18	BCLK to Data Out Valid	3	19	3	18	3	13.5	3	13.5	3	10.4	3	10.4	ns
19	BCLK to Data Out Invalid (Output Hold)	3	—	3	—	3	—	3	—	3	—	3	—	ns
21	BCLK to Data-Out High Impedance	—	15	—	15	—	12	—	12	—	10	—	10	ns
38	BCLK to Address, C _I OUT, LOCK, LOCKE, R/W, SIZx, TS, TLN _x , TM _x , TT _x , UP _{Ax} , BS _x High Impedance	—	15	—	15	—	12	—	12	—	10	—	10	ns
39	CLK to BB, TIP High Impedance	—	15	—	15	—	12	—	12	—	10	—	10	ns
40 ⁵	BCLK to BR, BB Valid (Signal Pre-driven)	—	—	3	17	—	—	3	12.6	—	—	3	9.9	ns
40a ⁵	BCLK to BB Valid (signal from three-state)	3	19	3	18	3	15.4	3	13.5	3	11.8	3	10.4	ns
50 ⁶	CLK to IPEND, PSTx, RSTO Valid	—	—	3	18	—	—	3	13.5	—	—	3	10.4	ns
57	BCLK to SAS Valid	3	19	3	18	3	15.4	3	13.5	3	11.8	3	10.4	ns
58	BCLK to SAS Invalid (Output Hold)	3	—	3	—	3	—	3	—	3	—	3	—	ns
59	BCLK to SAS High Impedance	—	15	—	15	—	12	—	12	—	10	—	10	ns
60	BCLK to TS Invalid (Output Hold)	3	—	3	—	3	—	3	—	3	—	3	—	ns
61	BCLK to BTT Valid	3	19	3	18	3	15.4	3	13.5	3	11.8	3	10.4	ns
62	BCLK to BTT Invalid (Output Hold)	3	—	3	—	3	—	3	—	3	—	3	—	ns
63	BCLK to BTT High Impedance	—	15	—	15	—	12	—	12	—	10	—	10	ns

NOTES:

- 40 MHz available only for the MC68EC060.
- Output timing is measured at the pin. The specifications assume a capacitive load of 50 pF. However, a maximum load of 130 pF may be used at each pin. Characterization data shows that at 130 pF loads, output propagation delays are as follows: 40 MHz, Pad at V_{CC}, multiply by prop delay by 1.4; 40 MHz, Pad at 5.5, multiply prop delay by 1.6; 50 MHz, Pad at V_{CC}, multiply prop delay by 1.4; 50 MHz, Pad at 5.5, multiply prop delay by 1.6; 66 MHz, Pad at V_{CC}, multiply prop delay by 1.3; 66 MHz, pad at 5.5, multiply prop delay by 1.4. Exceeding the 130-pF limit on any pin might affect long-term reliability and Motorola does not guarantee proper operation.
- When interfacing the processor to a system designed for 5-volt operation, the "Pad Starts at 5.5" column must be used when it is possible that the pin is at 5.5 volts when the processor begins to drive. Once a pin is driven by the processor and is not three-stated, the "Pad Starts at V_{CC}" column may be used. If the processor is in a system designed for 3.3-volt operation, use the "Pad Starts at V_{CC}" column always. This note not applicable to specs 11, 11a, 40, and 40a. Refer to note 5 for these specs.
- BCLK is not a pin signal name. It is a virtual bus clock derived from the combination of CLK and CLKEN. A BCLK rising edge coincides with a CLK in which CLKEN is asserted. A BCLK falling edge is insignificant. When a reference to BCLK is used to describe output timing, it means that the specific output transitions only on rising CLK edges in which CLKEN is asserted. A timing reference to CLK means that the output may transition off the rising CLK edge, including those rising edges in which CLKEN is negated.

5. When the processor drives these signals from a three-stated condition, use spec 11a or 40a. Use the "Pad Starts at V_{CC} " column or "Pad Starts at 5.5" column as applicable. Once these signals are driven, subsequent transitions are defined by spec 11 or 40. The "Pad Starts at 5.5" column is deleted from specs 11 and 40 since the processor drives up to the V_{CC} level only. \overline{BR} is never three-stated by the processor, and therefore, spec 40a does not apply for \overline{BR} .
- 6.) "Pad Starts at 5.5" does not apply since these signals are always driven.

PRELIMINARY

Electrical and Thermal Characteristics

12.7 INPUT AC TIMING SPECIFICATIONS ($V_{CC} = 3.3 V_{DC} \pm 5\%$)

Num	Characteristic	40 MHz ²		50 MHz		66 MHz		Unit
		Min	Max	Min	Max	Min.	Max.	
15	Data-In Valid to BCLK (Setup)	3	—	2	—	1	—	ns
16	BCLK to Data-In Invalid (Hold)	2	—	2	—	2	—	ns
17	BCLK to Data-In High Impedance (Read Followed by Write)	—	7	—	7	—	7	ns
22a	TA, Valid to BCLK (Setup)	12	—	10	—	7	—	ns
22b	TEA Valid to BCLK (Setup)	12	—	10	—	7	—	ns
22c	TCI Valid to BCLK (Setup)	12	—	10	—	7	—	ns
22d	TBI Valid to BCLK (Setup)	12	—	10	—	7	—	ns
22e	TRA Valid to BCLK (Setup)	12	—	10	—	7	—	ns
23	BCLK to TA, TEA, TCI, TBI, TRA Invalid (Hold)	2	—	2	—	2	—	ns
24	AVEC Valid to BCLK (Setup)	12	—	10	—	7	—	ns
25	BCLK to AVEC Invalid (Hold)	2	—	2	—	2	—	ns
41a	BB Valid to BCLK (Setup)	12	—	10	—	7	—	ns
41b	BG Valid to BCLK (Setup)	12	—	10	—	7	—	ns
41c	CDIS, MDIS Valid to BCLK (Setup)	12	—	10	—	7	—	ns
41d	IPL ₀ Valid to CLK (Setup)	3	—	2	—	1	—	ns
41e	BTT Valid to BCLK (Setup)	12	—	10	—	7	—	ns
41f	BGR Valid to BCLK (Setup)	12	—	10	—	7	—	ns
42a	BCLK to BB Invalid (Hold)	2	—	2	—	2	—	ns
42b	BCLK to BG Invalid (Hold)	2	—	2	—	2	—	ns
42c	BCLK to CDIS, MDIS Invalid (Hold)	2	—	2	—	2	—	ns
42d	CLK to IPL ₀ Invalid (Hold)	2	—	2	—	2	—	ns
42e	BCLK to BTT Invalid (Hold)	2	—	2	—	2	—	ns
42f	BCLK to BGR Invalid (Hold)	2	—	2	—	2	—	ns
44a	Address Valid to BCLK (Setup)	3	—	2	—	1	—	ns
44c	TT1 Valid to BCLK (Setup)	12	—	10	—	7	—	ns
44e	SNOOP Valid to BCLK (Setup)	12	—	10	—	7	—	ns
45a	BCLK to Address Invalid (Hold)	2	—	2	—	2	—	ns
45c	BCLK to TT1 Invalid (Hold)	2	—	2	—	2	—	ns
45e	BCLK to SNOOP Invalid (Hold)	2	—	2	—	2	—	ns
46	TS Valid to BCLK (Setup)	12	—	10	—	7	—	ns
47	BCLK to TS Invalid (Hold)	2	—	2	—	2	—	ns
49	BCLK to BB in High Impedance (MC68060 Assumes Bus Mastership)	—	3	—	3	—	3	ns
51	RSTI Valid to BCLK	3	—	2	—	1	—	ns
52	BCLK to RSTI Invalid (hold)	2	—	2	—	2	—	ns
53	Mode Select Setup to BCLK (RSTI Asserted)	12	—	10	—	7	—	ns
54	BCLK to Mode Selects Invalid (RSTI Asserted)	2	—	2	—	2	—	ns
64	CLA Valid to BCLK (Setup)	12	—	10	—	7	—	ns
65	BCLK to CLA Invalid (Hold)	2	—	2	—	2	—	ns

NOTES:

1. BCLK is not a pin signal name. It is a virtual bus clock derived from the combination of CLK and \overline{CLKEN} . A BCLK rising edge coincides with a CLK in which \overline{CLKEN} is asserted. A BCLK falling edge is insignificant. When a reference to BCLK is used to describe input timing, it means that the specific input is recognized only on rising CLK edges in which \overline{CLKEN} is asserted. A timing reference to CLK means that the input is recognized at any rising CLK edge, including those edges in which \overline{CLKEN} is negated.
2. 40 MHz available only for the MC68EC060.

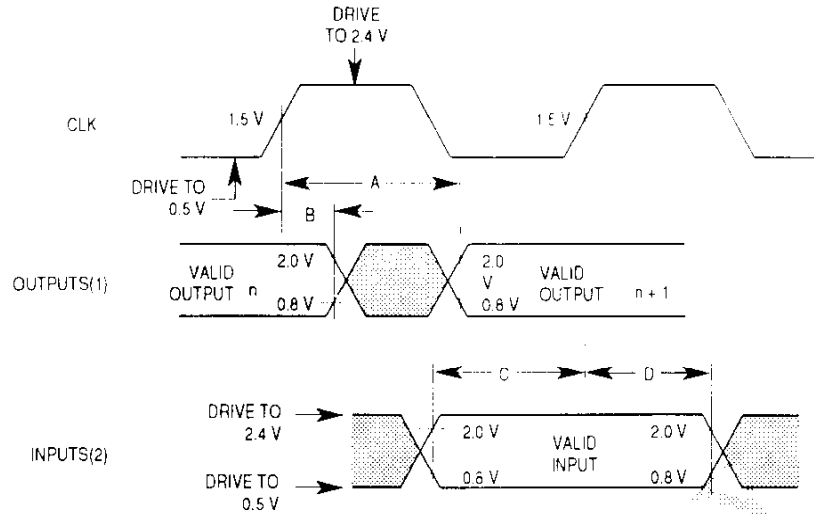

NOTES:

1. This output timing is applicable to all parameters specified relative to the rising edge of the clock.
2. This input timing is applicable to all parameters specified relative to the rising edge of the clock.

LEGEND:

- A. Maximum output delay specification.
- B. Minimum output hold time.
- C. Minimum input setup time specification.
- D. Minimum input hold time specification.

Figure 12-13. Drive Levels and Test Points for AC Specifications

PRELIMINARY

Electrical and Thermal Characteristics

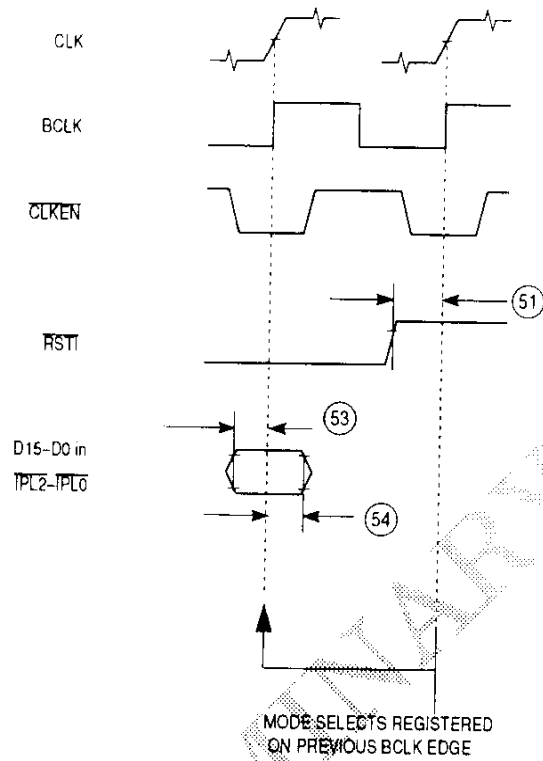
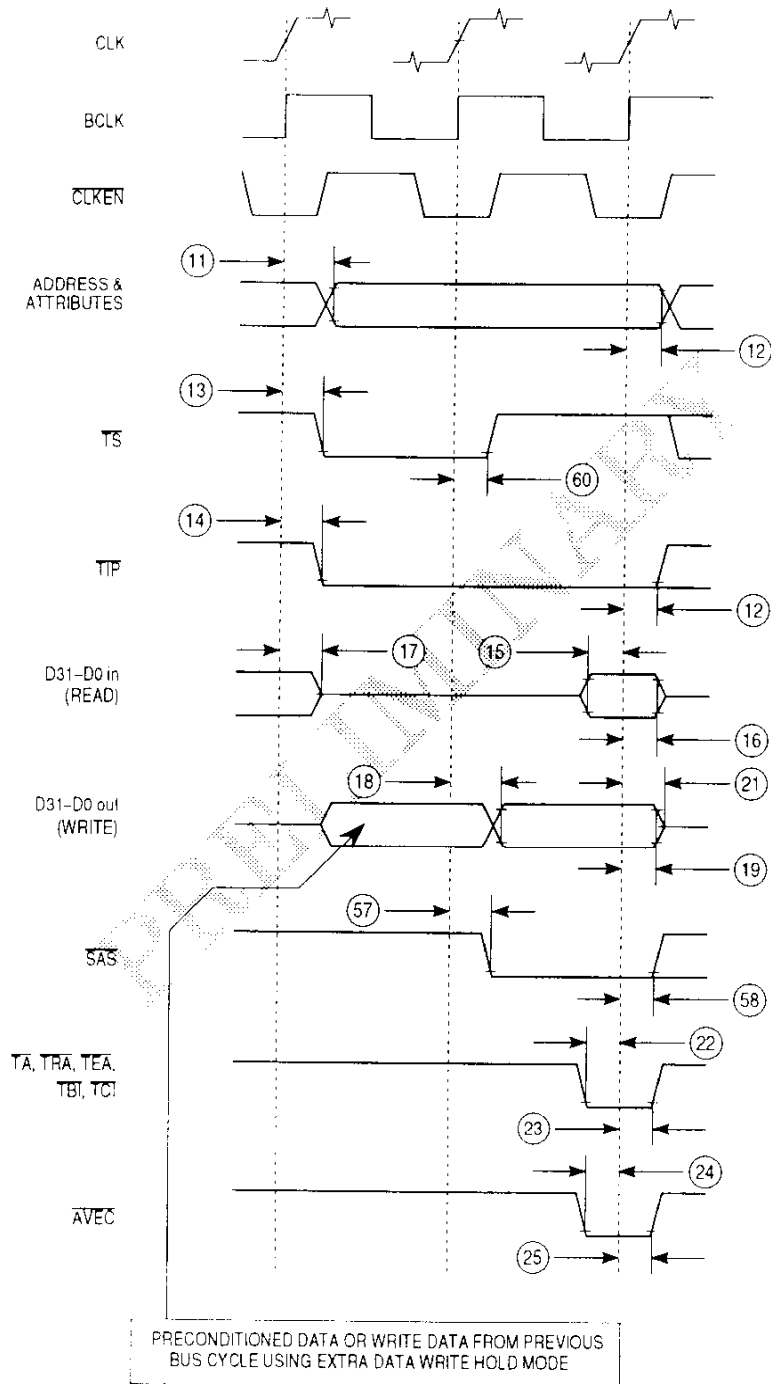

Figure 12-14. Reset Configuration Timing



NOTE: Address and attributes refer to the following signals:
 A31-A0, SIZ1, SIZ0, R/W, TT1, TT0, TM2-TM0, TLN1, TLN0, UPA1, UPA0, CIOU, BS3-BS0

Figure 12-15. Read/Write Timing

Electrical and Thermal Characteristics

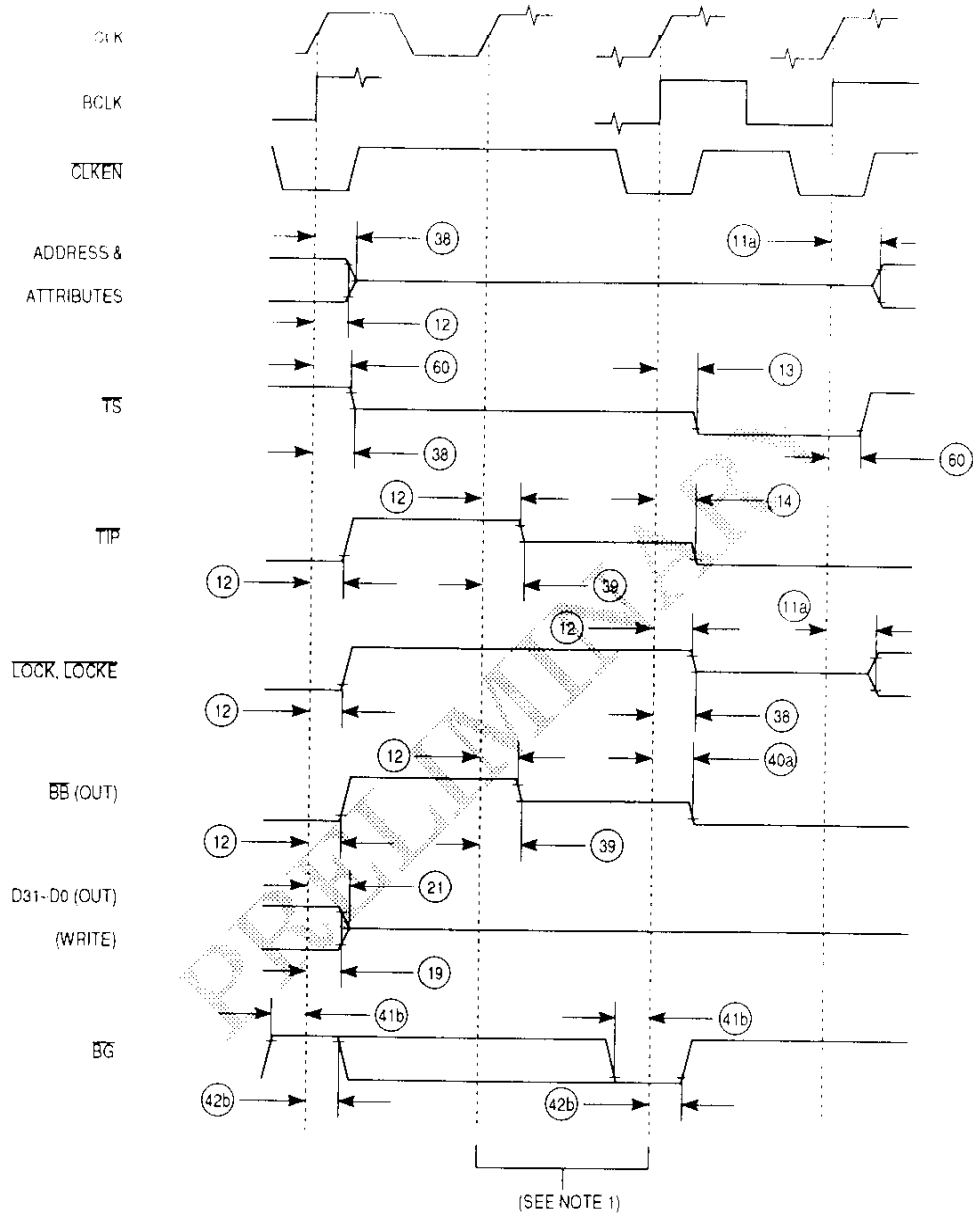

NOTES:

1. For illustrative purposes, a bus mastership hand-over is shown after a locked bus cycle sequence which adds one extra clock period between the bus mastership hand-over that would not occur for a bus mastership hand-over after a non-locked bus cycle.
2. Address and attributes refer to the following signals:
A31-A0, SIZ1, SIZ0, R/W, TT1, TT0, TM2-TM0, TLN1, TLN0, UPA1, UPAC, CIOCT, B53-B50

Figure 12-16. Bus Arbitration Timing

Electrical and Thermal Characteristics

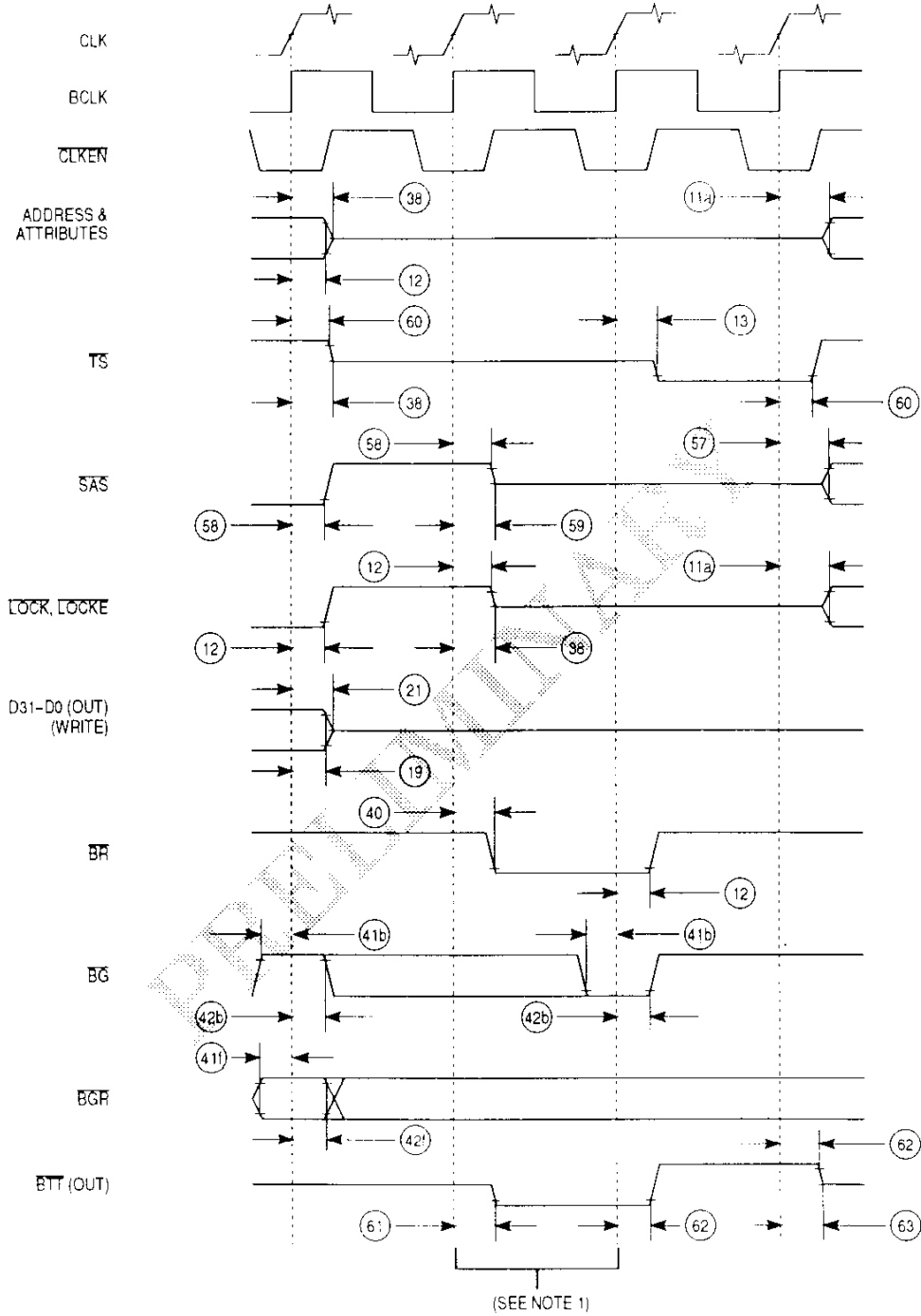

NOTES:

1. For illustrative purposes, a bus mastership hand-over is shown after a locked bus cycle sequence which adds one extra clock period between the bus mastership hand-over that would not occur for a bus mastership hand-over after a non-locked bus cycle.
2. Address and attributes refer to the following signals:
A31-A0, SIZ¹, SIZ², R/W, TT¹, TT², TM2-TM0, TLN¹, TLN², UPA¹, UPA², CIOUT, B53-B50

Figure 12-17. Bus Arbitration Timing (Continued)

Electrical and Thermal Characteristics

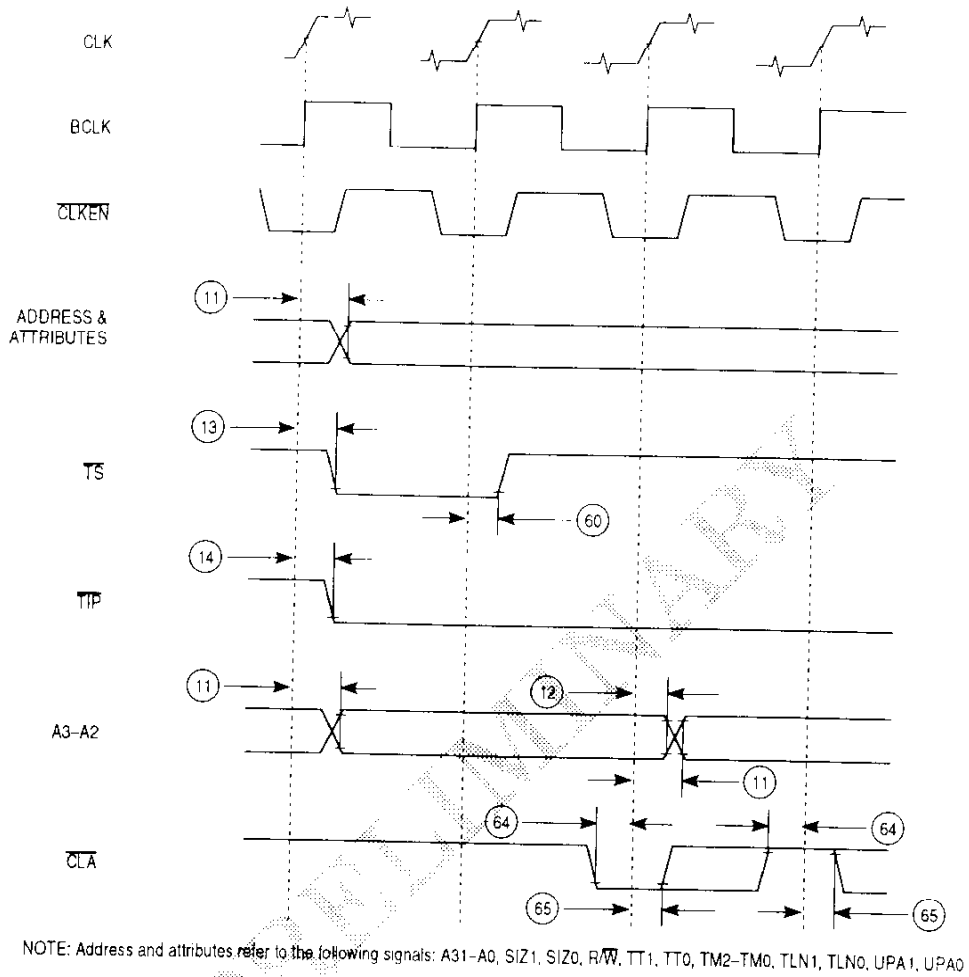

NOTE: Address and attributes refer to the following signals: A31-A0, SIZ1, SIZ0, R/W, TT1, TT0, TM2-TM0, TLN1, TLN0, UPA1, UPA0

Figure 12-18. CLA Timing

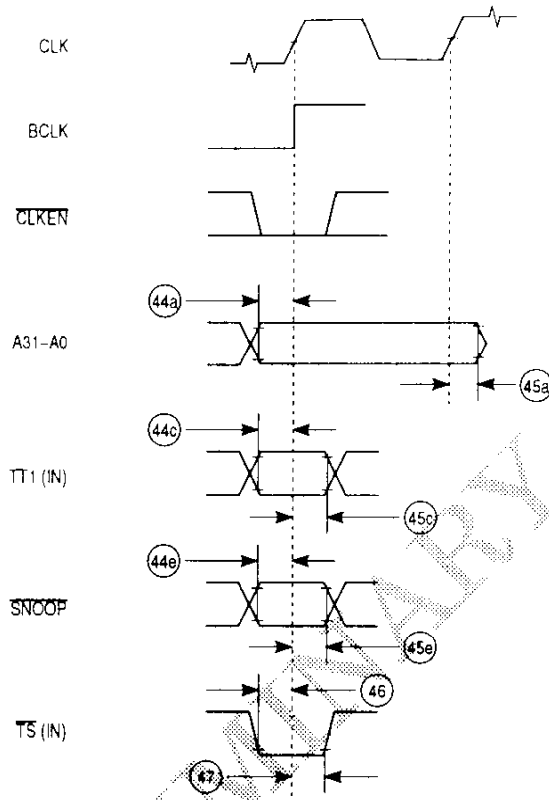

Figure 12-19: Snoop Timing

Electrical and Thermal Characteristics

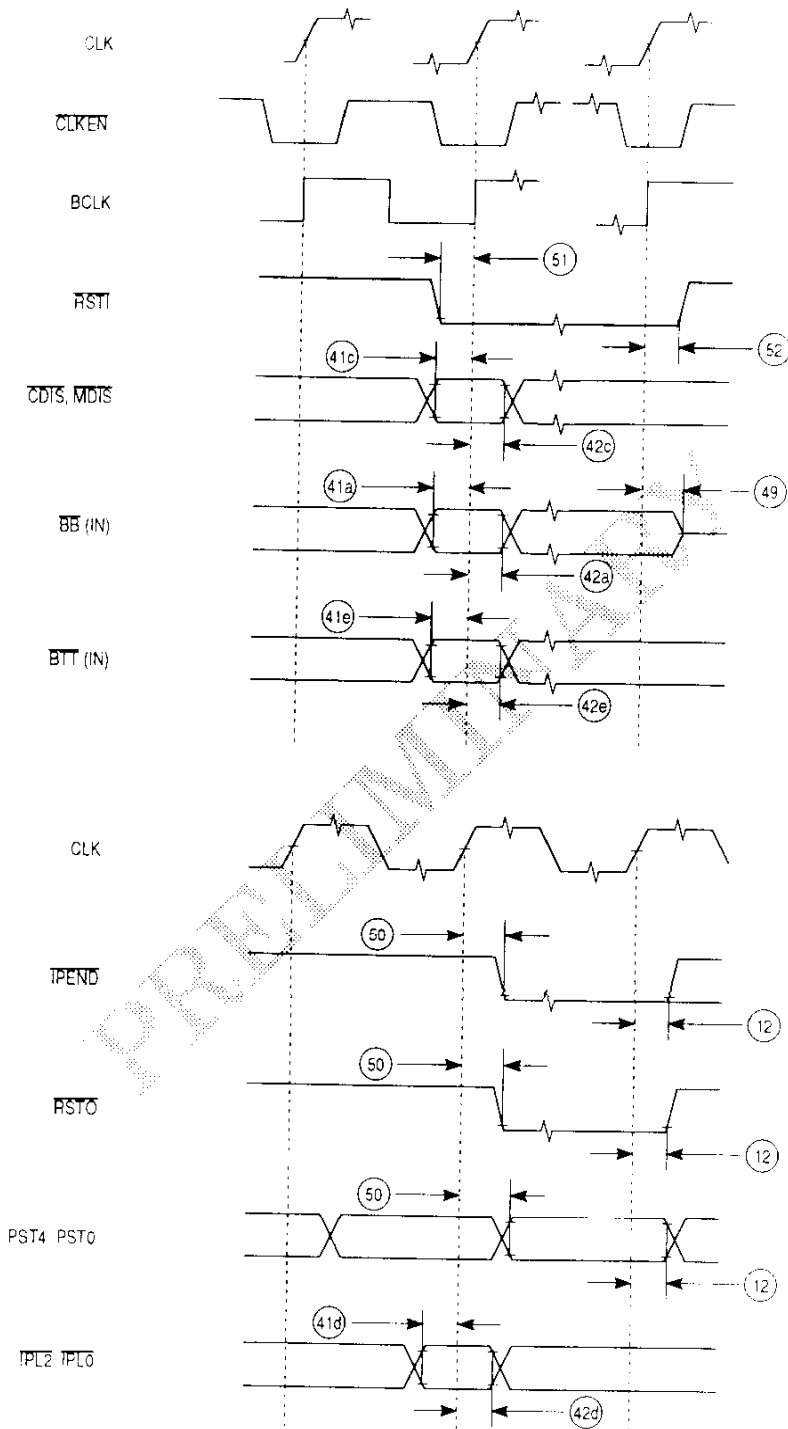

Figure 12-20. Other Signals Timing

SECTION 13 ORDERING INFORMATION AND MECHANICAL DATA

This section contains the ordering information, pin assignments, and package dimensions of the MC68060, MC68LC060, and MC68EC060.

13.1 ORDERING INFORMATION

The following table provides ordering information pertaining to the MC68060, MC68LC060, and MC68EC060 package types, frequencies, temperatures, and Motorola order numbers.

Package Type	Frequency	Maximum Junction Temperature	Minimum Ambient Temperature	Order Number
PGA—RC Suffix	50 MHz	110°C	0°C	MC68060RC50
PGA—RC Suffix	66 MHz	110°C	0°C	MC68060RC66
PGA—RC Suffix	50 MHz	110°C	0°C	MC68LC060RC50
PGA—RC Suffix	66 MHz	110°C	0°C	MC68LC060RC66
PGA—RC Suffix	40 MHz	110°C	0°C	MC68EC060RC40
PGA—RC Suffix	50 MHz	110°C	0°C	MC68EC060RC50
PGA—RC Suffix	66 MHz	110°C	0°C	MC68EC060RC66
208-Pin QFP—FE Suffix	50 MHz	110°C	0°C	MC68060FE50
208-Pin QFP—FE Suffix	66 MHz	110°C	0°C	MC68060FE66
208-Pin QFP—FE Suffix	50 MHz	110°C	0°C	MC68LC060FE50
208-Pin QFP—FE Suffix	66 MHz	110°C	0°C	MC68LC060FE66
208-Pin QFP—FE Suffix	40 MHz	110°C	0°C	MC68EC060FE40
208-Pin QFP—FE Suffix	50 MHz	110°C	0°C	MC68EC060FE50
208-Pin QFP—FE Suffix	66 MHz	110°C	0°C	MC68EC060FE66

13.2 PIN ASSIGNMENTS

The following are the pin assignments for the MC68060, MC68LC060, and MC68EC060 package types.

13.2.1 MC68060, MC68LC060, and MC68EC060 Pin Grid Array (RC Suffix)

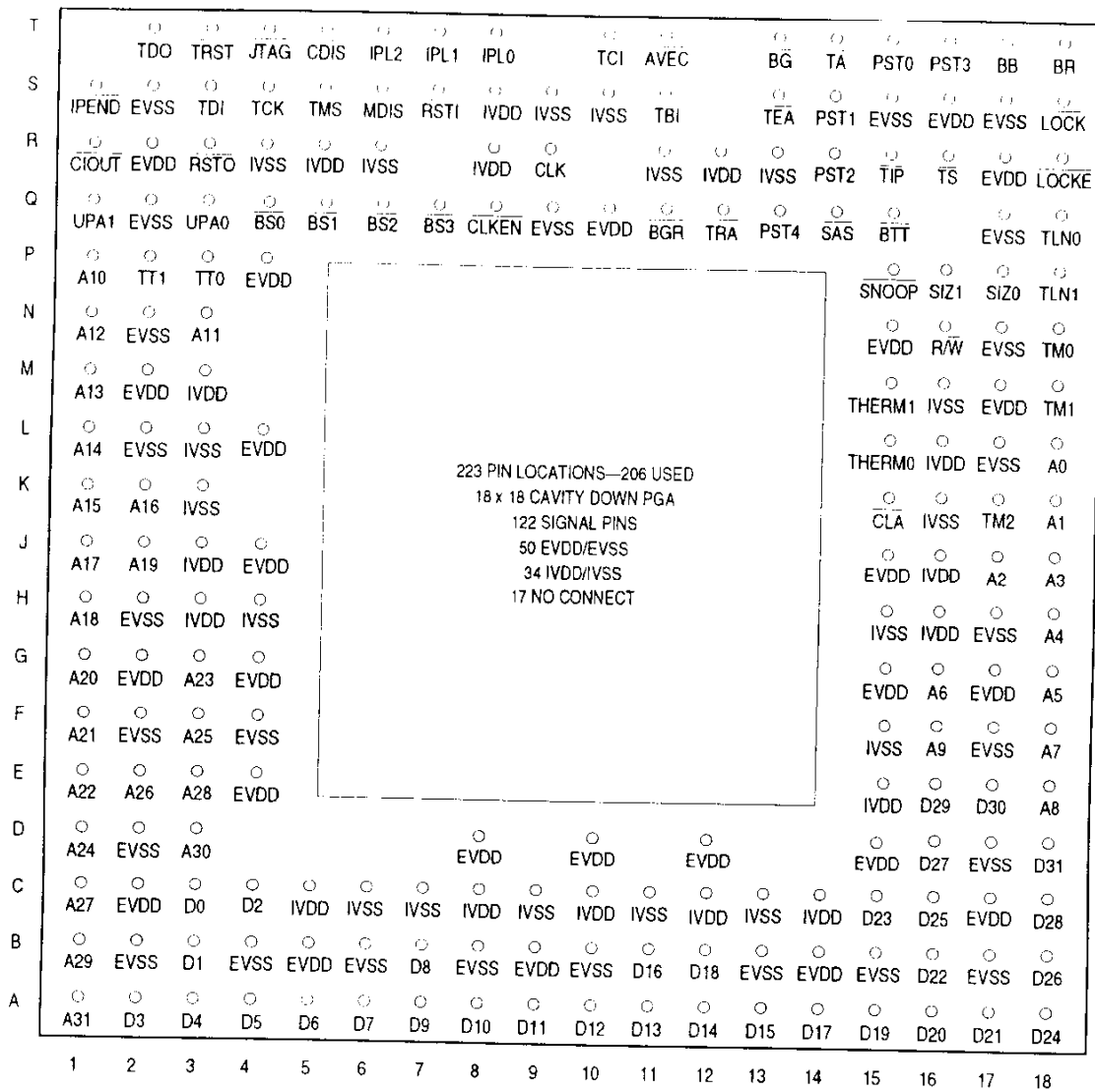

Pin Groups	GND (VSS)	VCC (VDD)
Internal Logic	C6, C7, C9, C11, C13, F15, H4, H15, K3, K16, L3, M16, R4, R6, R11, R13, S9, S10	C5, C8, C10, C12, C14, E15, H3, H16, J3, J16, L16, M3, R5, R8, R12, S8
Output Drivers	B2, B4, B6, B8, B10, B13, B15, B17, D2, D17, F2, F4, F17, H2, H17, L2, L17, N2, N17, Q2, Q9, Q17, S2, S15, S17	B5, B9, B14, C2, C17, D8, D10, D12, D15, E4, G2, G4, G15, G17, J4, J15, L4, M2, M17, N15, P4, Q10, R2, R17, S16

13.2.2 MC68060, MC68LC060, and MC68EC060 Quad Flat Pack (FE Suffix)

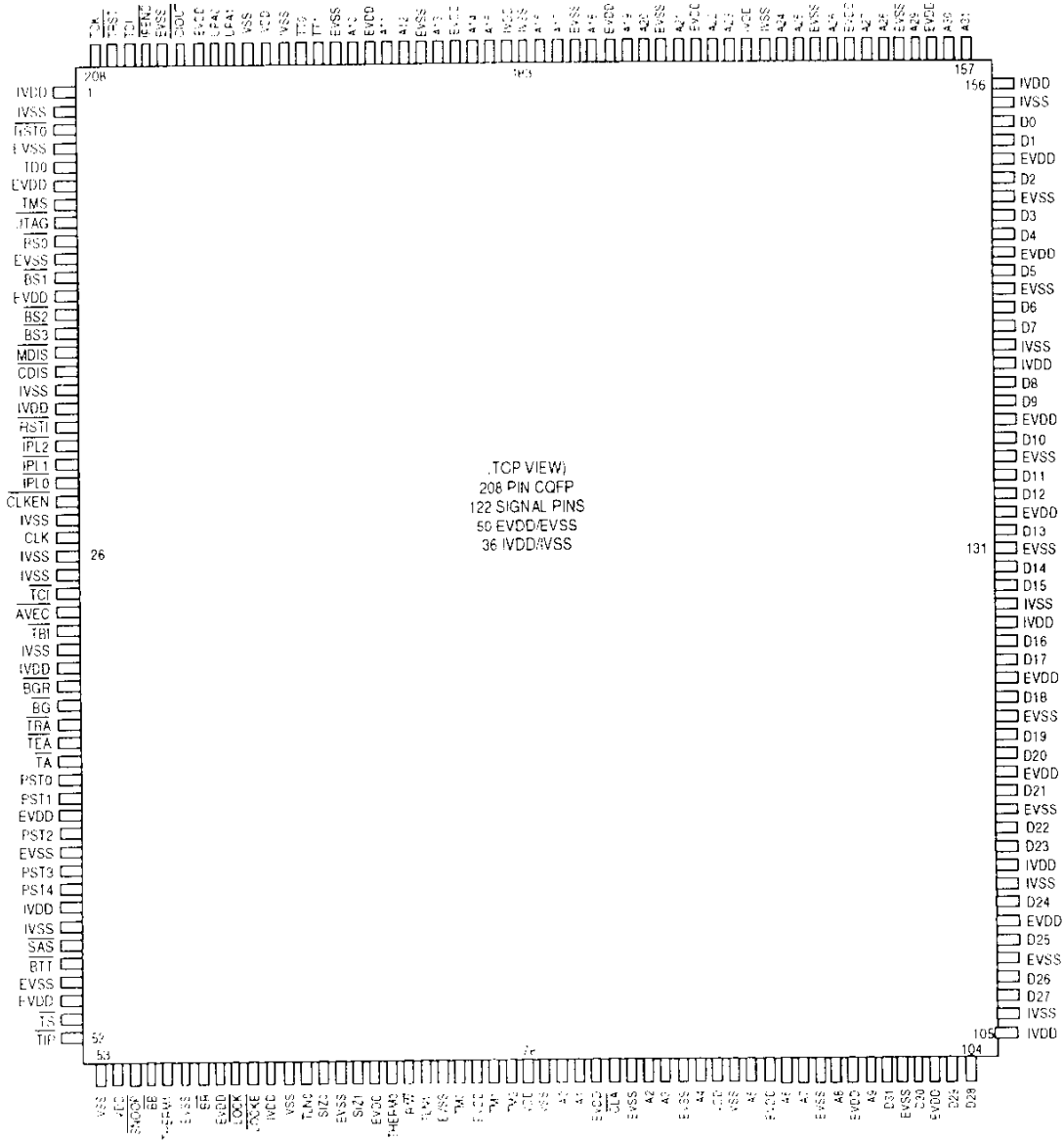

Pin Groups	GND (VSS)	VCC (VDD)
Internal Logic	2, 17, 24, 26, 27, 31, 46, 53, 64, 79, 90, 106, 113, 128, 142, 155, 169, 183, 197, 199	1, 18, 32, 54, 63, 78, 89, 105, 114, 127, 141, 156, 170, 184, 198
Output Drivers	4, 10, 42, 49, 58, 67, 73, 84, 87, 95, 100, 109, 117, 122, 131, 136, 145, 150, 161, 166, 175, 180, 189, 194, 204	6, 12, 40, 50, 60, 69, 75, 82, 92, 97, 102, 111, 119, 124, 133, 138, 147, 152, 159, 164, 173, 178, 187, 192, 202

Ordering Information and Mechanical Data

13.3 MECHANICAL DATA

Figure 13-1 illustrates the MC68060, MC68LC060 and MC68EC060 PGA package dimensions. Figure 13-2 illustrates the MC68060, MC68LC060, and MC68EC060 CQFP package dimensions. Due to space limitation, Figure 13-2 is represented by a general (smaller) package outline rather than showing all 208 leads.

MC68060 PGA
CASE NUMBER: 993A-01

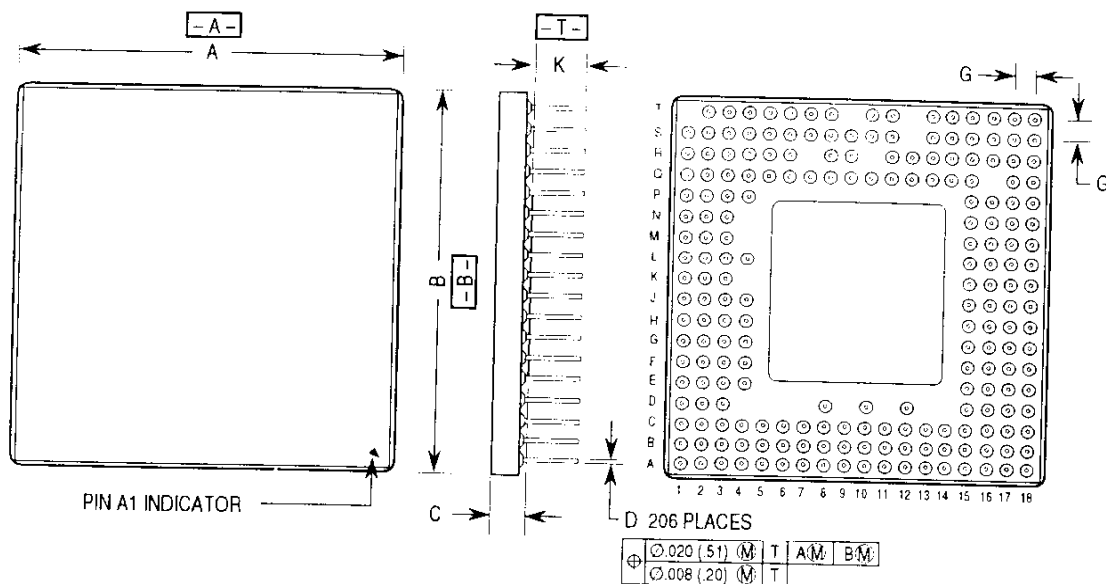

DIM	MILLIMETERS		INCHES	
	MIN	MAX	MIN	MAX
A	46.74	47.75	1.840	1.880
B	46.74	47.75	1.840	1.880
C	2.79	3.05	0.110	0.140
D	0.41	0.51	0.016	0.020
G	2.54 BSC		0.100 BSC	
K	3.81	4.32	0.150	0.170

NOTES:
1. DIMENSIONS AND TOLERANCING PER ANSI Y14.5M 1982.
2. CONTROLLING DIMENSION: INCH

Figure 13-1. PGA Package Dimensions (RC Suffix)

Ordering Information and Mechanical Data

MC68060 CQFP
CASE NUMBER: 994-01

4 x 52 TIPS

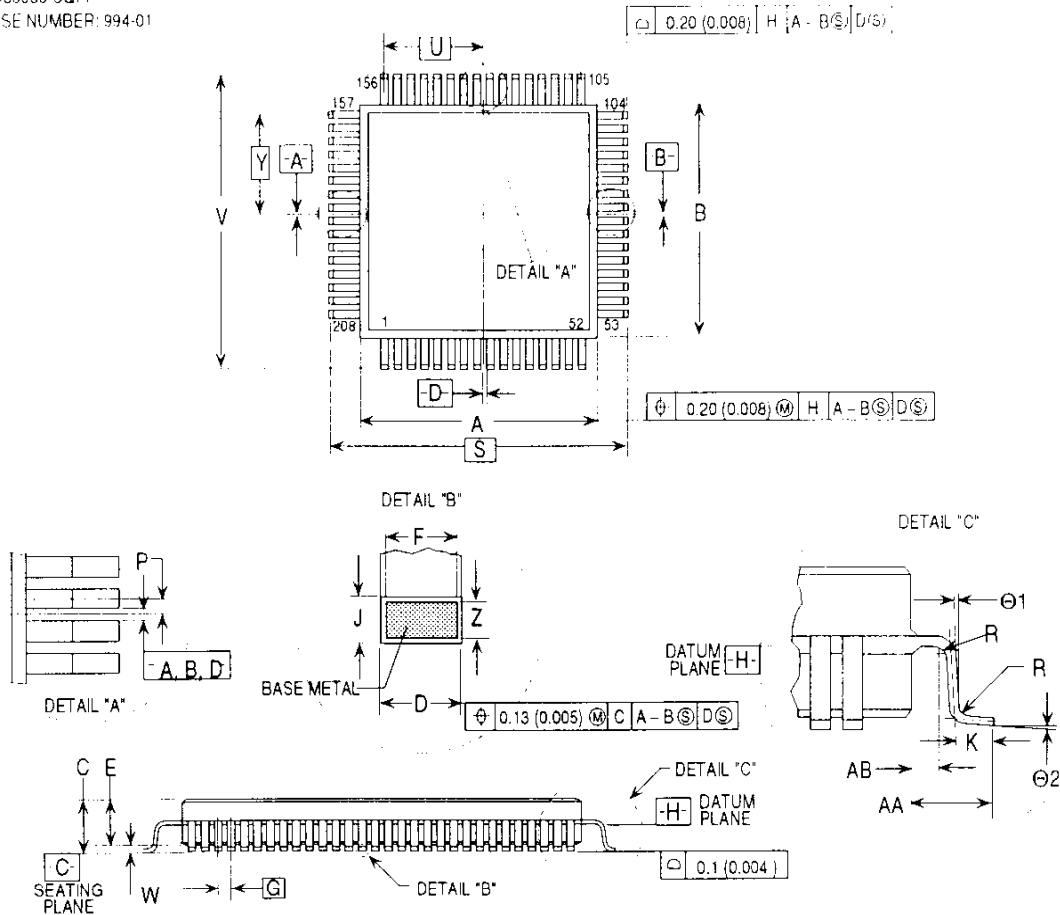

DIM	MILLIMETERS		INCHES	
	MIN	MAX	MIN	MAX
A	26.86	27.75	1.057	1.093
B	26.86	27.75	1.057	1.093
C	—	4.15	—	0.163
D	0.18	0.27	0.007	0.011
E	3.00	3.70	0.118	0.146
F	0.17	0.23	0.007	0.009
G	0.50 BSC		0.020 BSC	
W	0.25	—	0.010	—
J	0.13	0.18	0.005	0.007
K	0.45	0.55	0.018	0.022
U	15.30 BSC		0.602 BSC	
P	0.25 BSC		0.010 BSC	
Ø2	1	7	1	7
R	0.15 REF		0.006 REF	
S	30.60 BSC		1.205 BSC	
U	15.30 BSC		0.602 BSC	
V	30.60 BSC		1.205 BSC	
AB	0.95 REF		0.037 REF	
AA	1.80 REF		0.071 REF	
Y	15.30 BSC		0.602 BSC	
Z	0.12	0.13	0.005	0.005
H	1	7	1	7

NOTES:

1. DIMENSIONING AND TOLERANCING PER ANSI Y14.5M, 1982
2. CONTROLLING DIMENSION: MILLIMETER. INCHES ARE IN ()
3. DATUM PLANE -H- IS LOCATED AT BOTTOM OF LEAD AND IS COINCIDENT WITH THE LEAD WHERE THE LEAD EXITS THE PLASTIC BODY AT THE BOTTOM OF THE PARTING LINE.
4. DATUMS -A-, -B-, AND -D- TO BE DETERMINED AT DATUM PLANE -H-.
5. DIMENSIONS S AND V TO BE DETERMINED AT SEATING PLANE -C-.
6. DIMENSIONS A AND B DEFINE MAXIMUM CERAMIC BODY DIMENSIONS INCLUDING GLASS PROTRUSION AND MISMATCH OF CERAMIC BODY TOP AND BOTTOM.

Figure 13-2. QFP Package Dimensions (FE Suffix)

APPENDIX A

MC68LC060

The MC68LC060 is a derivative of the MC68060. The MC68LC060 has the same execution unit and MMU as the MC68060, but has no FPU. The MC68LC060 is 100% pin compatible with the MC68060. Disregard all information concerning the FPU when reading this manual. The following difference exists between the MC68LC060 and the MC68060:

- The MC68LC060 does not contain an FPU. When floating-point instructions are encountered, a floating-point disabled exception is taken.
- Bits 31–16 of the processor configuration register contain 0000010000110001, identifying the device as an MC68LC/EC060.



APPENDIX B MC68EC060

The MC68EC060 is a derivative of the MC68060. The MC68EC060 has the same execution unit as the MC68060, but has no FPU or paged MMU, which embedded control applications generally do not require. Disregard information concerning the FPU and MMU when reading this manual. The MC68EC060 is pin compatible with the MC68060. The following differences exist between the MC68EC060 and the MC68060:

- The MC68EC060 does not contain an FPU. When floating-point instructions are encountered, a floating-point disabled exception is taken.
- Bits 31–16 of the processor configuration register contain 0000010000110001, identifying the device as an MC68LC/EC060.
- The $\overline{\text{MDIS}}$ pin name has been changed to the JS0 pin and is included for boundary scan purposes only.

B.1 ADDRESS TRANSLATION DIFFERENCES

Although the MC68EC060 has no paged MMU, the four TTRs (ITT0, ITT1, DTT0, and DTT1) and the default transparent translation (defined by certain bits in the TCR) operate normally and can still be used to assign cache modes and supervisor and write protection for given address ranges. All addresses can be mapped by the four TTRs and the default transparent translation.

B.2 INSTRUCTION DIFFERENCES

The PFLUSH and PLPA instructions, the SRP and URP registers, and the E- and P-bits of the TCR are not supported by the MC68EC060 and must not be used. Use of these instructions and registers in the MC68EC060 exhibits poor programming practice since no useful results can be achieved. Any functional anomalies that may result from their use will require system software modification (to remove offending instructions) to achieve proper operation.

The PLPA instruction operates normally except that when an address misses in the four TTRs, instead of performing a table search operation, the access cache mode and write protection properties are defined by the default transparent translation bits in the TCR. The address register contents are never changed since all addresses are always transparently translated. The PLPA instruction can only generate an access error exception only on supervisor or write protection violation cases. The PFLUSH instruction operates as a virtual NOP instruction.

When the MOVEC instruction is used to access the SRP and URP registers and the E- and P-bits in the TCR, no exceptions are reported. However, those bits are undefined for the MC68EC060 and must not be used.



APPENDIX C

MC68060 SOFTWARE PACKAGE

The purpose of the M68060 software package (M68060SP) is to supply, for a target operating system, system exception handlers and user library software that provide:

- Software emulation for integer instructions not implemented in MC68060 hardware via the new unimplemented integer instruction exception.
- System V ABI-compliant library subroutines to help avoid using unimplemented integer instructions.
- IEEE floating-point support for the on-chip floating-point unit (FPU) as well as software emulation of floating-point instructions, data types, and addressing modes not implemented in MC68060 hardware.
- System V ABI-compliant library subroutines to help avoid using unimplemented floating-point instructions.

The design goals in implementing the M68060SP are as follows:

- Position-independent code
- Re-entrant code
- Object code size of less than 64 Kbytes for the complete kernel release
- No assembly-code-to-assembly-code conversion software required
- Minimum assembly code compilation required for system integration
- One-time port; future upgrades done by software patch instead of recompilation
- Easily downloadable from a bulletin board

The M68060SP is divided into five separate modules. This partitioning provides system integrators flexibility in choosing portions of the M68060SP that are applicable to their system. For instance, a system using the MC68EC060 or MC68LC060 has no use for the floating-point related modules. The following modules are provided:

1. Unimplemented integer instruction exception handler
2. Unimplemented integer instruction library
3. Full floating-point kernel exception handlers
4. Partial floating-point kernel exception handlers
5. Floating-point library



MC68060 Software Package

Each module has pre-defined addresses used by the target operating system as entry points into the M68060SP routines. These pre-defined addresses will remain unchanged to ensure that future releases of the M68060SP do not require recompilation.

The three kernel modules require some system-dependent subroutines to be supplied by the target system. These modules also contain a call-out dispatch table. Each entry in the call-out dispatch table represents an external function needed by that module. The call-out dispatch table must be filled by the system integrator with the relative address (relative to the top of the module) of the desired external function. This module-relative addressing ensures full position independence.

C.1 MODULE FORMAT

Each module consists of the following parts:

1. Call-out Dispatch Table
2. Entry-point Dispatch Section
3. Code section

The call-out dispatch table is used by the module to reference external functions. The unimplemented integer and floating-point library modules do not require call-out dispatch tables. For the other three modules, the call-out dispatch table contains a maximum of 32 call-out entries. Each entry is 4 bytes long; hence, the call-out dispatch table size is 128 bytes. This table must be supplied by the system integrator. Each entry must contain the relative addresses of external functions, relative to the top of the call-out table.

For example, if the call-out dispatch table defines the first location to be the `_mem_read` entry and the third entry defines the `_mem_write` entry, the table appears as shown in Figure C-1.

```
        xref      _mem_read, _mem_write
        xdef      _top
_top:
        dc.l _mem_read - _top
        dc.l _mem_write - _top
        .
        .
        .
        dc.l $00000000
* End of Call-out Dispatch Table. The module (pseudo-assembly module) must
* immediately follow:
```

Figure C-1. Call-Out Dispatch Table Example

The MC68060SP release has an example call-out dispatch table for each module. Since the call-out dispatch table is system dependent, it is placed in a file separate from the next two sections of the module. Care must be taken when porting the MC68060SP to ensure that each module is kept intact.

C

The next two sections of the module do not require system customizing. To provide these sections in a "black box", they are packaged in "pseudo-assembly" files. The main advantage of this method of packaging is that changing the syntax of this pseudo-assembly file can be done by any word processor with global search and replace capability. Also, when it is time to update the MC68060SP, only these pseudo-assembly files need to be replaced, the system customized code does not need modification.

Figure C-2 shows an example pseudo-assembly file.

```
dc.l    $60ff0000,$20920000,$60ff0000,$1f5c0000
dc.l    $60ff0000,$0d040000,$60ff0000,$0eb80000
dc.l    $60ff0000,$24300000,$60ff0000,$22ca0000
.
.
.
dc.l    $00000000,$00000000,$00000000,$00000000
```

Figure C-2. Example Pseudo-Assembly File

The Entry-point Dispatch Section must immediately follow the call-out dispatch table (kernel modules only). The function entry points are implemented as address offsets from the top of the module. Each function entry point is eight bytes in width. Each entry point contains an unconditional branch to another location within the code section. This feature ensures that future releases of the module would not necessitate a recompile of the system-customized software envelope.

For example, consider the case of the M68060SP floating-point kernel module. This module has a 128-byte call-out dispatch table. Assuming that a symbol `_060FPSP_TOP` points to the top of the module, and a jump to the third function of the module is needed, the system call is as such:

```
bra    _060FPSP_TOP+128+(2*8)
```

To gain additional performance, it is possible to avoid the double-branch penalty through the Entry-point Dispatch Section by determining the branch target of each entry point into the associated code section function addresses. However, this may make it more difficult to upgrade to future releases without recompiling software envelopes that call into the M68060SP.

The code section contains the actual M68060SP software. If the code section requires a call to an external function, it calculates the address of the external function given the information contained in the appropriate call-out entry. The code section is normally entered via a branch instruction from the entry-point dispatch section.

Figure C-3 provides a visual example of the module interface. The symbol names outside the boxes represent global symbol names defined by the system integrator. Internal symbols used by the M68060SP source code are represented as labels inside the boxes. Note that the call-out code example contains approximate code and is shown to emphasize that module-relative address needs to be filled into the call-out dispatch table.



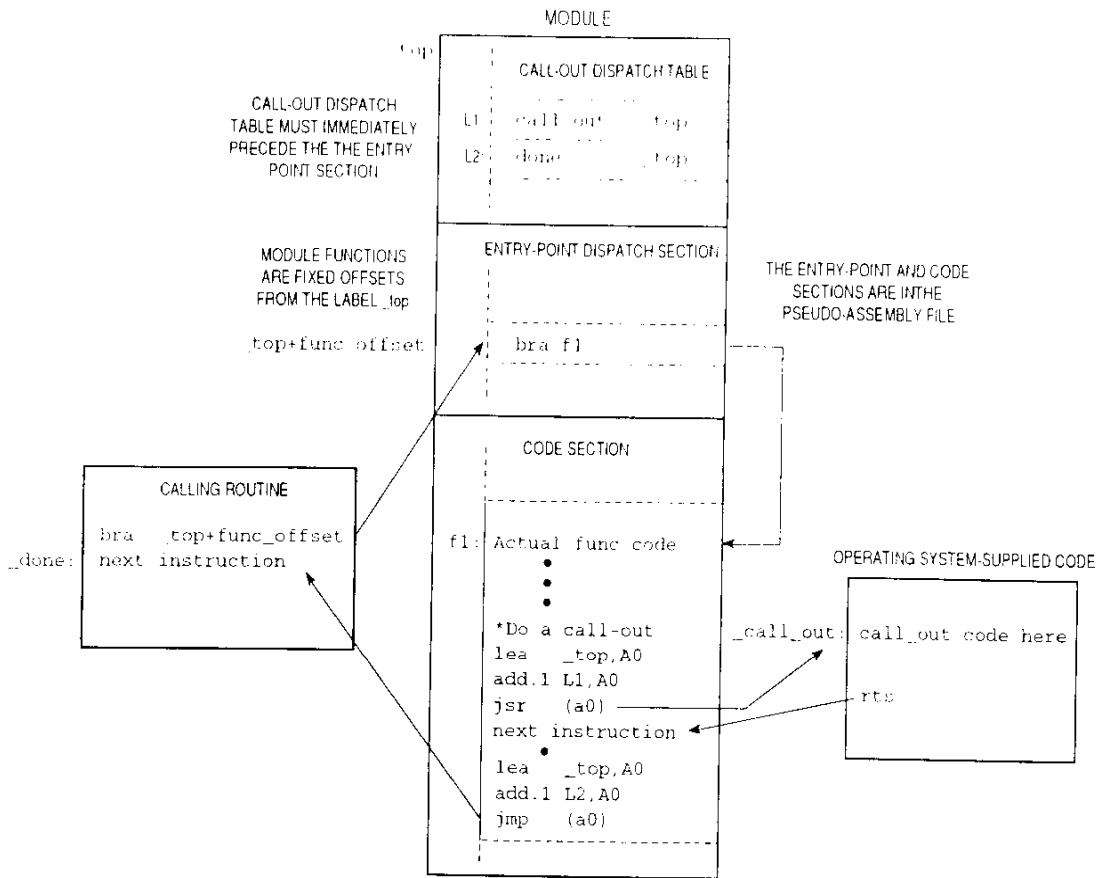

Figure C-3. Module Call-In, Call-Out Example

Table C-1 shows the code size of each module.

Table C-1. Call-Out Dispatch Table and Module Size

Module Name	Call-Out Dispatch Table Size	Entry-Point + Code Section Size	Total Module Size
Unimplemented Integer	128 bytes	8K-128 bytes	8K bytes
Unimplemented Integer Instruction Library	0 bytes	4K bytes	4K bytes
Full Floating-Point Kernel	128 bytes	56K-128 bytes	56K bytes
Floating-Point Library	0 bytes	34K bytes	34K bytes
Partial Floating-Point Kernel	128 bytes	35K-128 bytes	35K bytes

C.2 UNIMPLEMENTED INTEGER INSTRUCTIONS

The MC68060 left some low-use integer instructions unimplemented to streamline internal operations. This results in overall system performance improvement at the expense of software emulation of the unimplemented integer instructions. The M68060SP provides user object-code compatibility by providing the code needed to emulate these instructions via the unimplemented integer instruction exception. The M68060SP also provides a software

library that can be used to avoid these unimplemented instructions for new programs that can be recompiled.

The unimplemented integer instructions include 64-bit divide and multiply, move peripheral data, CMP2, CHK2, and CAS2. In addition, CAS used with a misaligned effective address is also unimplemented. Refer to the *M68000 Family Programmer's Reference Manual* (M68000PM/AD) for details on the operation of these instructions. The unimplemented integer instructions are:

DIVU.L	<ea>,Dr:Dq	64/32 ⇒ 32r,32q
DIVS.L	<ea>,Dr:Dq	64/32 ⇒ 32r,32q
MULU.L	<ea>,Dr:Dq	32*32 ⇒ 64
MULS.L	<ea>,Dr:Dq	32*32 ⇒ 64
MOVEP	Dx,(d16,Ay)	size = W or L
MOVEP	(d16,Ay),Dx	size = W or L
CHK2	<ea>,Rn	size = B, W, or L
CMP2	<ea>,Rn	size = B, W, or L
CAS2	Dc1:Dc2,Du1:Du2,(Rn1):(Rn2)	size = W or L
CAS	Dc,Du,<ea>	size = W or L, misaligned <ea>

C.2.1 Integer Emulation Results

Numerical and condition code results produced by the MC68060ISP (see **C.2.2 Module 1: Unimplemented Integer Instruction Exception (MC68060ISP)**) are equivalent to those in previous M68000 family processors. In addition, as with the MC68060 hardware, if any condition code bits are stated as undefined for the exceptional instruction, then they remain unchanged from the previous instruction.

C.2.2 Module 1: Unimplemented Integer Instruction Exception (MC68060ISP)

When the MC68060 encounters an unimplemented integer instruction, the MC68060 initiates exception processing at vector number 61. A type \$0, four-word stack frame is created. The stack frame's stacked program counter (PC) points to the unimplemented integer instruction.

The M68060SP determines the instruction that caused the exception and emulates the instruction using implemented integer instructions. This emulation includes the proper condition code effects as produced by the instruction if it had been implemented in hardware. No floating-point instructions are used within this module (to ensure that this module can be used for the MC68LC060 and MC68EC060).

When emulating the unimplemented integer instructions, there are conditions that require the M68060SP to emulate an exception. The M68060SP emulates an exception by cleaning up the stack to the conditions prior to executing the exception handler, converting the original stack frame to the appropriate stack frame, and then branching to those system-supplied exception handlers.



C.2.2.1 UNIMPLEMENTED INTEGER INSTRUCTION EXCEPTION MODULE ENTRY POINTS.

The `_isp_unimp` function is implemented such that the unimplemented integer instruction exception vector table entry typically points directly to `_isp_unimp`. If the system software chooses to perform operations prior to entering the `_isp_unimp` function, it may do so as long as the system stack points to the exception stack frame at the time of entry.

C.2.2.2 UNIMPLEMENTED INTEGER INSTRUCTION EXCEPTION MODULE CALL-OUTS.

The call-outs `_real_trace`, `_real_chk`, `_real_divbyzero`, and `_real_access` are defined to provide the system integrator a choice of either having the module point directly to the actual trace, chk, divide-by-zero, and access error handler, or to an alternate routine that would fetch the address of the exception handler from the vector table prior to jumping to the actual handlers. The direct implementation is ideal for systems that do not anticipate any changes to the vector table and performance is more critical. The indirect approach of consulting the vector table is more accurate in that if the instruction were implemented, the actual handler's address is fetched from the appropriate vector table entry before branching there.

Other call-outs which are common to the floating-point kernel module are discussed in **C.4 Operating System Dependencies**. These call-outs include the discussion of the `_real_access` and other operating-system-dependent functions.

The `_isp_done` call-out is provided as a means for the system to do any clean-up, if any is necessary, before executing the RTE instruction to return to normal instruction execution. The unimplemented integer instruction exception handler will either branch to this call-out or create an appropriate exception frame and branch to the call-outs `_real_trace`, `_real_chk`, `_real_divbyzero`, or `_real_access` routines as outlined previously.

C.2.2.3 CAS MISALIGNED ADDRESS AND CAS2 EMULATION-RELATED CALL-OUTS AND ENTRY POINTS.

The CAS instruction with misaligned address and CAS2 emulation is the most system dependent of all MC68060ISP code. The emulation code may require interaction with a system's interrupt, paging and access error recovery mechanisms. The emulation algorithm uses the MOVEC of the BUSCR register to assert the `LOCK` and `LOCKE` signals during emulation. The following is a description of the main steps in the emulation process:

1. Decode instruction and fetch all data from registers as necessary. In addition, if any of the operand pages are non-resident, then they must be paged in and not be allowed to be paged out or marked invalid for any reason until the emulation process ends. For each operand address, the MC68060ISP calls `_real_lock_page()` which must be provided by the host operating system to "lock" the pages. This routine should also check to see if the address passed is valid and writable. If not, then an error result should be returned to the MC68060ISP.
2. The MC68060ISP then calls the "core" emulation code for either "cas" or "cas2". The MC68060ISP references the "core" routines by calling either the `_real_cas()` or `_real_cas2()` call-outs. If the emulation code provided is sufficient for a given system, then the system integrator can make these call-outs immediately re-enter the package by calling either `_isp_cas()` or `_isp_cas2()` entry points. These entry points will perform the required emulation. If the "core" routines provided need to be replaced by a more



system-specific solution, then the new user-generated emulation code should supply the routines via the `_real_cas()/_real_cas2()` call-outs, and should then re-enter the MC68060ISP through the entry point `_isp_cas_finish()` or `_isp_cas2_finish()` when complete.

3. After emulation is completed, the pages which may have been "locked" from being paged out earlier must now be "unlocked". To accomplish this, the MC68060ISP executes a `_real_unlock_page()` call-out for each operand.

For most systems, the entry-points `_isp_cas()` and `_isp_cas2()` routines should provide sufficient emulation results. However, it is up to the system integrator to judge whether or not these routines are sufficient, or that a more system-specific solution is needed. The following is a description of some aspects of the `_isp_cas()` and `_isp_cas2()` emulation code.

1. Interrupt levels 0-6 are immediately masked. If the appropriate pages have been paged in and have been checked for write permission in `_real_lock_page()`, then only physical bus errors can occur within this code sequence. The routine restores the previous interrupt mask level upon completion of the algorithm. (Note: if a system, by design, allows level 7 interrupts to occur while emulating the CAS or CAS2 instructions, then the operand data corruption may occur. External hardware may be added to the system to physically mask all interrupts whenever $\overline{\text{LOCK}}$ is asserted.)
2. The operand ATC is loaded for each operand using the PLPAW instruction. In addition, any fresh cache entries corresponding to the operands are pushed from the cache using CPUSHL instruction. Note: the MC68040 processor initiated the pushes, if necessary, within the locked bus region. MC68060 hardware, however, pushes the cache lines, if necessary, outside of the locked bus region for TAS and aligned CAS instructions. The MC68060ISP emulates the MC68060 processor approach.
3. The main algorithm steps are pre-fetched into the instruction cache if the cache is enabled. The algorithm attempts to allow only operand data bus accesses during the locked bus instruction sequence. This strategy reduces the number of cycles that the $\overline{\text{LOCK}}$ signal will be asserted.
4. Before performing the read(s)/write(s), the bus $\overline{\text{LOCK}}$ signal is asserted by the emulation code by using the MOVEC of the BUSCR register. All reads and writes when $\overline{\text{LOCK}}$ is asserted will be precise. $\overline{\text{LOCK}}$ will not actually appear on the bus until the first bus read cycle.
5. The $\overline{\text{LOCKE}}$ signal will be asserted for the final operand write of the emulation sequence.
6. The actual read(s)/write(s) are performed using the MOVES instruction for both user and supervisor accesses. The system DFC is set to the appropriate mode before executing MOVES and PLPAW instructions.



MC68060 Software Package

Assuming that the system integrator elects to use the `_isp_cas()` and `_isp_cas2()` entry points for instruction emulation, three routines are made available to the access error exception handler to provide more options when a bus error (\overline{TEA}) is encountered when in these critical routines:

1. `_isp_cas_inrange()`: Accepts an instruction address as an input argument and returns a failing or passing value corresponding to whether the address is within the `_isp_cas()` or `_isp_cas2()` code region. This function can be used within a system's access error handler to determine if a PLPA or MOVES instruction has incurred a bus error (\overline{TEA} asserted) within the `_isp_cas()` or `_isp_cas2()` code region.
2. `_isp_cas_restart()`: If an access error handler encounters a recoverable physical bus error (\overline{TEA} asserted) and the `_isp_cas_inrange()` routine returns an "in-range" value, then the operand read/write sequence will be restarted through this entry point. Note that by design of the MC68060, any exception occurring while \overline{LOCK} is asserted automatically negates it.
3. `_isp_cas_terminate()`: If an access error handler encounters a non-recoverable physical bus error (\overline{TEA} asserted) and the `_isp_cas_inrange()` routine returns an "in-range" value, it can re-enter the package through this entry point. The package creates a new access error frame.

As long as the `_real_lock_page()` routine operates properly, only physical bus errors caused by the PLPA or MOVES instructions can occur within the critical code sequence. It is the access error handler's responsibility to determine whether or not it is appropriate to restart the locked sequence or to terminate the CAS or CAS2 emulation. More than likely, at the time of the bus error, all maskable interrupts have been masked. It is the responsibility of the access error handler to re-enable the interrupts if desired.

For the recoverable bus error cases, the stacked PC of the access error frame can be replaced with the `_isp_cas_restart()` address once the cause of the bus error has been removed. Code execution continues at the `_isp_cas_restart()` entry point, when the RTE of the access error handler is executed.

For the non-recoverable bus error case, the stacked PC must be replaced with the `_isp_cas_terminate()` address to ensure that the original CAS or CAS2 emulation stack frame is removed from the system stack, and system is placed in the same state just before the CAS or CAS2 emulation was attempted. Also, the Fault Address FSLW must be copied to the appropriate registers prior to executing the RTE of the access error handler. After the RTE instruction is executed, code execution resumes at the `_isp_cas_terminate()` entry point. When the access error handler is re-entered, the stacked PC contains the address of the CAS or CAS2 instruction, the Fault Address contains the passed Fault Address from the previous access error handling, and the FSLW contains the passed FSLW from the previous access error handling. Figure C-4 outlines the call-outs and entry-points associated with the CAS and CAS2 emulation.

C

```

* _real_cas(), _real_cas2(): MC68060ISP call out to provide choice
* of using supplied _isp_cas() and _isp_cas2() routines or to
* write an alternate routine more fitted for the system.

* _isp_cas(), _isp_cas2(): CAS and CAS2 core routine entry point that
* can be called from _real_cas() and _real_cas2() if the system wishes
* to use the CAS and CAS2 emulation code provided with the package.
* The flow is:
*   (exception) -> _isp_unimp -> _real_cas(2) -> _isp_cas(2)

* _isp_cas_inrange(): Subroutine entry point provided by the 68060ISP
* for use by the access error handler that reports if a given
* address resides within the _isp_cas() or _isp_cas2() routines.
* Inputs:
*   a0 = instruction address in question
* Outputs:
*   d0 = 0 -> success; non-zero -> failure

* _isp_cas_terminate(): Entry point provided by the MC68060ISP for
* use by an access error handler to create an access error frame for
* a process and to exit the CAS or CAS2 emulation gracefully.
* Inputs:
*   a0 = faulting address
*   d0 = Fault Status Longword

* _isp_cas_restart(): Entry point provided by the 68060ISP for use
* by an access error handler to re-start _isp_cas() and _isp_cas2()
* if a recoverable bus error occurs within the _isp_cas() and _isp_cas2()
* routines.

* _isp_cas_finish(), _isp_cas2_finish(): Entry point provided by the
* MC68060ISP for use by system-specific implementations of cas. Enter
* here to exit gracefully through the package.
* The flow is:
*   (exception) -> _isp_unimp -> _real_cas(2) -> (new code)
*   -> _isp_cas(2)_finish
* This requires close examination of the _isp_cas() and _isp_cas2() source
* code.

```

Figure C-4. CAS and CAS2 Call-Outs and Entry Points

C.2.3 Module 2: Unimplemented Integer Instruction Library (MC68060ILSP)

The M68060SP provides a library version of the following unimplemented integer instructions: 64-bit divide, 64-bit multiply, and CMP2. This version can be compiled with user applications desiring the functionality of these instructions. Using the library method, an application does not have to incur the overhead of the unimplemented integer instruction exception.

The routines are System V ABI compliant. Currently, the arguments are expected on the stack by the M68060SP library routines. For `_divu64`, `_divs64`, `_mulu64`, and `_muls64`, the results are not returned in a pair of data registers as with the actual instructions, but rather in a two-long-word memory array pointed to by a pointer argument provided by the caller.



MC68060 Software Package

The condition code register upon return from all of the library routines is correct. Figure C-5 provides a C-code representation of the integer library routines in the M68060SP.

```

/* 64-bit (32x32 -> 64) unsigned multiply routine */
void _mulu64(multiplier,multiplicand,result)
    unsigned int multiplier;
    unsigned int multiplicand;
    unsigned int *result; /* array for result */

/* 64-bit (32x32 -> 64) signed multiply routine */
void _muls64(multiplier,multiplicand,result)
    int multiplier;
    int multiplicand;
    int *result; /* array for result */

/* 64-bit (32/32 -> 32r:32q) unsigned divide routine */
void _divu64(divisor,dividend_hi,dividend_lo,result)
    unsigned int divisor;
    unsigned int dividend_hi, dividend_lo;
    unsigned int *result; /* array for result */

/* 64-bit (32/32 -> 32r:32q) signed divide routine */
void _divs64(divisor,dividend_hi,dividend_lo,result)
    int divisor;
    int dividend_hi,dividend_lo;
    int *result; /* array for result */

/* CMP2 using an "A"ddress or "D"ata register. size = byte. */
void _cmp2_{D,A}b(rn,bounds)
    int rn;
    char *bounds; /* pointer to byte bounds array */

/* CMP2 using an "A"ddress or "D"ata register. size = word. */
void _cmp2_{D,A}w(rn,bounds)
    int rn;
    short *bounds; /* pointer to word bounds array */

/* CMP2 using an "A"ddress or "D"ata register. size = longword. */
void _cmp2_{D,A}l(rn,bounds)
    int rn;
    int *bounds; /* pointer to longword bounds array */

```

Figure C-5. C-Code Representation of Integer Library Routines

For example, to use a 64-bit divide instruction, do a "bsr" or "jsr" to the entry-point defined by the MC68060ILSP entry table. A compiler-generated code sequence for unsigned multiply could resemble Figure C-6.

The library routines also return the correct condition code register value. If this is important, then the caller of the library routine must make sure that the value is not lost while popping other items off of the stack. An example of using the CMP2 instruction is given in Figure C-7.

The unimplemented integer instruction library module contains no operating system dependencies and does not require a call-out dispatch table. If the instruction being emulated is a

C

```

* mulh.l <ea>,Dh:Dl
* mulh.l multiplier,d1:d0

    subq.l  #8,sp                ; make room for result on stack
    pea    (sp)                 ; pass: result addr on stack
    move.l  d0,(sp)             ; pass: multiplicand on stack
    move.l  _multiplier,(sp)    ; pass: multiplier on stack
    bsr.l   _060LSP_TOP+818     ; branch to multiply routine
    add.l   #8,sp               ; clear arguments from stack
    move.l  (sp)+,d1            ; load result[63:32]
    move.l  (sp)+,d0            ; load result[31:0]

```

Figure C-6. MUL Instruction Call Example

```

* cmp2.l <ea>,Rn
* cmp2.l _bounds,d0

    pea    _bounds              ; pass ptr to bounds
    move.l  d0,-(sp)            ; pass Rn
    bsr.l   _060LSP_TOP+$48     ; branch to "cmp2" routine
    add.l   #8,sp              ; clear arguments from stack

```

Figure C-7. CMP2 Instruction Call Example

divide and the source operand is a zero, then the library routine (as it is last instruction) executes an implemented divide using a zero source operand so that an integer divide-by-zero exception will be taken. Although the exception stack frame will not point to the correct instruction, the user can at least be able to record that such an event occurred.

C.3 FLOATING-POINT EMULATION PACKAGE (MC68060FPSP)

The MC68060 does not implement some floating-point instructions, addressing modes, and data types on-chip in order to streamline internal operations. This results in an overall system performance improvement at the expense of software emulation of these unimplemented instructions, addressing modes, and data types. The M68060SP provides three separate modules that are related to floating-point operations. The first floating-point module is the full floating-point kernel module. This module is used for applications that require emulation of the full MC68881 floating-point instruction set, data-types, and IEEE-754 exception handling. The second floating-point module is the floating-point library. This library is provided as a separate module for applications that need to avoid the latency incurred by the F-line exception processing for unimplemented floating-point instructions. However, this method requires recompiling of existing software to implement subroutine calls. The third floating-point module, the partial floating-point kernel module, is optional and is used primarily in systems that also integrate the floating-point library. The partial floating-point kernel module is similar in function to the full floating-point kernel except that it does not contain the unimplemented floating-point instruction exception handler. This module is provided for the purpose of saving memory space. Otherwise, the full floating-point kernel module must be used instead.



MC68060 Software Package

The floating-point emulation package provides the following services:

1. Floating-point unimplemented instruction exception handler
2. Floating-point unimplemented data-type exception handler
3. Floating-point unimplemented effective address handler
4. Floating-point arithmetic exception handlers
5. Floating-point library

Table C-2 lists a brief comparison among the M68000 family floating-point processors.

Table C-2. FPU Comparison

Is the default result stored in the destination register for exception-enabled register-to-register or memory-to-register operations?				
FPU	INEX	DIVZ	OPERR	SNAN
MC68881/882	Yes	No	No	No
MC68040	Yes	No	No	No
MC68060	Yes*	No	No	No
Is the default result stored for exception-enabled FMOVE OUT?				
FPU	INEX	DIVZ	OPERR	SNAN
MC68881/882	Yes	—	Yes	Yes
MC68040	Yes	—	Yes+*	Yes+*
MC68060	Yes+*	—	Yes+*	Yes+*

+ Undefined result written by processor

* Floating-point software package assistance needed to store the default result

The unimplemented floating-point instructions, effective addresses, and data types that are handled by the M68060SP are outlined in Table C-3 and Table C-4.



Table C-3. Unimplemented Instructions

General Monadic Operations	
FACOS	FLOGN
FASIN	FLOGNP1
FATAN	FMOVECR
FATANH	FSIN
FCOS	FSINCOS
FCOSH	FSINH
FETOX	FTAN
FETOXM1	FTANH
FGETEXP	FTENTOX
FGETMAN	FTWOTOX
FLOG10	FLOG2
General Dyadic Operations	
FMOD	FREM
FSCALE	—
Conditionals	
FTRAPcc	FDBcc
FScC	—
Unimplemented Effective Address	
FMOVEM.X (dynamic register list)	FMOVEM.L #immediate of 2 or 3 control regs
F<op>.X #immediate,FPn	F<op>.P #immediate,FPn

Table C-4. Unimplemented Data Formats and Data Types

Data Formats/Data Types	SGL	DBL	EXT	DEC	Byte	Word	Long
Normalized	S	S	S	U	S	S	S
Zero	S	S	S	U	S	S	S
Infinity	S	S	S	U	—	—	—
NAN	S	S	S	U	—	—	—
Denormalized	U	U	U	U	—	—	—
Unnormalized	—	—	U	U	—	—	—

Where:

S = Implemented Data Format, handled by the MC68060

U = Unimplemented Data Format, handled by the M68060SP

C.3.1 Floating-Point Emulation Results

All numerical results and condition code settings produced by the M68060FPSP and visible to the user are identical to those produced by the MC68881/882 and MC68040 with the following exception: the M68060FPSP transcendental calculation results are not the same as for the MC68881/882, because the algorithms used in the MC68881/882 (CORDIC) cannot be effectively implemented in software. However, the error bound of the M68060FPSP transcendental routines (same as for the MC68040 routines) are equivalent or superior.



For floating-point arithmetic instructions, the error bound is one-half unit in the last place of the destination format in the round-to-nearest mode, and one unit in the last place in the

MC68060 Software Package

other rounding modes. Transcendental instructions have an error bound of less than 0.6 unit in the last place of double precision. The error bound for decimal conversions is 0.97 unit in the destination precision for the round-to-nearest mode and 1.47 units in the last digit of the destination precision for the other rounding modes.

C.3.2 Module 3: Full Floating-Point Kernel

The full floating-point kernel includes the following exception handlers:

1. Floating-point unimplemented instruction handler
2. Floating-point unimplemented data type handler
3. Unimplemented effective address handler
4. Floating-point arithmetic exception handlers

When the full floating-point kernel is integrated into the system, the entire MC68881 floating-point coprocessor instruction set object-code compatibility is attained, and IEEE-754 trap reporting compliance is achieved. This module stands on its own and is ideal for systems whose applications were written with the full MC68881 instruction set in mind.

C.3.2.1 FULL FLOATING-POINT KERNEL MODULE ENTRY POINTS. The `_fbsp_fline`, `_fbsp_unsupp` and `_fbsp_effadd` are entry points supplied for the floating-point unimplemented instruction, floating-point unimplemented data type and unimplemented effective address handlers respectively. The `_fbsp_snan`, `_fbsp_operr`, `_fbsp_ovfl`, `_fbsp_unfl`, `_fbsp_dz`, `_fbsp_inex` entry points are supplied as the floating-point arithmetic exception handlers. These entry points are implemented such that the appropriate vector table entries typically point directly to these functions. If the system chooses to perform certain system functions prior to entering these entry points, the system can do so with the condition that the system stack pointer must point to the exception stack frame at the time of the function entry. Figure C-12 illustrates the relationship of the module to the vector table and system software envelope.

C.3.2.2 FULL FLOATING-POINT KERNEL MODULE CALL-OUTS. The full floating-point kernel requires the following call-outs: `_real_fline`, `_real_fpu_disabled`, `_real_trace`, `_real_trap`, `_real_bsun`, `_real_snan`, `_real_operr`, `_real_ovfl`, `_real_unfl`, `_real_dz`, `_real_inex`, `_fbsp_done`. In addition, **C.4 Operating System Dependencies** discusses the `_real_access` call-out and other call-outs that are common to the unimplemented integer instruction exception module.

C.3.2.2.1 The F-Line Exception Call-Outs. When the `_fbsp_fline` function is entered, it checks the stack frame format and determines whether this is an unimplemented floating-point instruction, FPU disabled or F-line illegal exception. If it is determined that the FPU is disabled, the call-out `_real_fpu_disabled` is taken. It is up to the system software to either emulate the instruction using integer instructions or simply turn on the FPU before returning to restart the instruction. If the instruction is not recognized as an MC68881 instruction, the call-out `_real_fline` is taken. The system software is responsible for taking the appropriate action. If neither the FPU disabled or F-line illegal exception cases is true, then the M68060SP emulates the instruction.



C.3.2.2.2 System-Supplied Floating-Point Arithmetic Exception Handler Call-Outs.

The call-outs `_real_bsun`, `_real_snan`, `_real_operr`, `_real_ovfl`, `_real_unfl`, `_real_dz`, `_real_inex` are needed only if the system turns on the floating-point exceptions via the floating-point control register (FPCR) exception enable byte. These call-outs point to the arithmetic handlers that must be supplied for IEEE trap enabled operation. Documentation for these handlers are fully explained in **Section 6 Floating-Point Unit**. Additional information on how these call-outs are reached is found in **C.3.2.3 Bypassing Module-Supplied Floating-Point Arithmetic Handlers** and **C.3.2.4 Exceptions During Emulation**.

C.3.2.2.3 Exception-Related Call-Outs. When in the process of emulating any of the floating-point exception handlers, there are conditions that require the M68060SP to emulate an access error, trace, or trap exception. The M68060SP does so by cleaning up the stack to the conditions prior to executing the exception handler, converting the original stack frame to the appropriate stack frame and then branching to those system-supplied exception handlers.

The call-outs `_real_access`, `_real_trace`, and `_real_trap` are defined to provide the system integrator a choice of either having the module point directly to the actual access error, trace and trap exception handlers or to an alternate routine that would calculate the exception handler address from the vector table prior to jumping to actual handlers. The direct implementation is ideal for systems that do not anticipate any changes to the vector table, and for which performance is more critical. The indirect approach of consulting the vector table is more accurate in that if the instruction were implemented, the actual handler's address is fetched from the appropriate vector table entry before branching there.

C.3.2.2.4 Exit Point Call-Outs. The `_fjsp_done` call-out is provided as a means for the system to do any clean-up, if necessary, before executing the RTE instruction to return to normal instruction execution. All the supplied floating-point handlers will either branch to this call-out or exit through the call-outs `_real_fline`, `_real_fpu_disabled`, `_real_trace`, `_real_trap`, `_real_access`, `_real_bsun`, `_real_snan`, `_real_operr`, `_real_ovfl`, `_real_unfl`, `_real_dz`, and `_real_inex` exit points.

C.3.2.3 BYPASSING MODULE-SUPPLIED FLOATING-POINT ARITHMETIC

HANDLERS. A system that does not require full IEEE trap enabled exception compliance or does not require the services of the exceptional operand, may choose to bypass the `_fjsp_{ovfl,unfl,snan,operr,dz,inex}` entry points. To better assess whether or not to write a customized floating-point arithmetic handler, it is important to know what the processor hardware does and what the M68060SP handlers do individually.

The term "opclass" is used in the following paragraphs. An opclass zero instruction refers to a floating-point general instruction whose source operand(s) and destination operand are all floating-point data registers (no operands in memory). An opclass two instruction refers to a floating-point general instruction in which one source operand is in memory or an integer data register, but the destination is a floating-point data register. An opclass three instruction refers to an FMOVE instruction that has a memory or integer data register destination.



C.3.2.3.1 Overflow/Underflow. Floating-point overflow and underflow are nonmaskable exceptions on the MC68060 (as they were on the MC68040). When either occur, the corresponding exception is taken regardless, whether the user overflow or underflow enable bit is set in the FPCR or not. The purpose of these nonmaskable exceptions is to allow software to generate the default underflow and overflow results as produced by the MC68881/882.

The M68060FPSP acts differently according to the four following cases:

1. Overflow/Underflow disabled, overflow occurred, and inexact is enabled—the M68060FPSP exception handler, `_fmsp_ovfl`, calculates the default result and stores this value at the destination. Second, the exceptional operand value is calculated and restored, with exceptional status, into the FPU with an `FRESTORE` instruction. The overflow stack frame is then converted into an inexact stack frame. Finally, a branch is taken to the operating system-supplied call-out (`_real_inex`) for the user enabled inexact exception handler.
2. Overflow/Underflow disabled, underflow occurred, inexact is enabled, and the result is inexact—the M68060FPSP exception handler, `_fmsp_unfl`, calculates the default result and stores this value at the destination. Second, the exceptional operand value is calculated and restored, with exceptional status, into the FPU with an `FRESTORE` instruction. The overflow stack frame is then converted into an inexact stack frame. Finally, a branch is taken to the operating system-supplied call-out (`_real_inex`) for the user-enabled inexact exception handler.
3. Overflow, underflow, and inexact disabled—the M68060FPSP exception handler, `_fmsp_ovfl` or `_fmsp_unfl`, calculates the default result rounded to the proper mode and precision, and stores this result at the destination. The handler then returns the processor to normal processing.
4. Overflow or underflow enabled—the M68060FPSP exception handler, `_fmsp_ovfl` or `_fmsp_unfl`, calculates the default result and stores this value at the destination. Second, the exceptional operand value is calculated and restored, with exceptional status, into the FPU with an `FRESTORE` instruction. Next, a branch is taken to the operating system-supplied call-out (`_real_{ovfl,unfl}`) for the user enabled overflow or underflow exception handler. At this point, the overflow/underflow exception frame is on the stack. The exceptional operand can be located in the `FSAVE` frame. The destination operand is not available. The source operand may not be available. The following short list details the information available to `_real_{ovfl,unfl}` when the M68060FPSP passes control there:
 - Memory or data register destination
 - exception stack frame: the six-word post-instruction stack frame contains the PC of the next instruction and the effective address of the destination operand.
 - in the `FSAVE` frame: the exceptional operand which is the intermediate result rounded to the destination precision, with the 15-bit exponent biased as a normal extended-precision number. The user `ovfl/unfl` handler must execute an “`FSAVE`” to retrieve this value.
 - at the destination location: default result (same as with exceptions disabled).
 - `FPIAR`: address of the instruction that underflowed/overflowed.



- Floating-point data register destination:
 - exception stack frame: the four-word pre-instruction stack frame contains the PC of the next instruction.
 - in the FSAVE frame: the exceptional operand which is the intermediate result mantissa rounded to extended precision, with an exponent bias of $\$3FFF+\6000 for underflow and $\$3FFF-\6000 for overflow rather than $\$3FFF$. In cases of catastrophic overflow/underflow, the exceptional operand exponent is set to $\$0000$. The user `ovfl/unfl` handler must execute an FSAVE to retrieve this value.
 - at the destination location: the default underflow/overflow result.
 - FPIAR: address of the instruction that underflowed/overflowed.
 - FPSR: the bits are set according to the default result.

Note

Unlike the MC68040, the MC68060 FPU hardware does not provide the exceptional operand on overflow or underflow for use by an exception handler. Therefore, the M68060FPSP overflow and underflow handlers must emulate the entire faulted instruction in order to calculate the exceptional operand for the user enabled overflow or underflow handler.

Finally, if the result of the floating-point multiplication unit is a normalized extended-precision number with a zero exponent, then the processor will incorrectly take an underflow exception. The M68060SP detects and corrects this case.

C.3.2.3.2 Signalling Not-A-Number, Operand Error. On the MC68060, the signalling not-a-number (SNAN) and operand error (OPERR) exceptions cause pre-instruction exceptions for opclass zero and two instructions and post-instruction exceptions for opclass three instructions. The processor takes exception vector number fifty-four for the SNAN exception and vector number fifty-two for the OPERR exception. The FSAVE frames for the exceptions are valid and contain the source operands converted to extended precision.

SNAN and OPERR were non-maskable exceptions on the MC68040 for opclass three instructions with byte, word, or long-word destination formats. The exceptions were non-maskable so that the MC68040FPSP software could provide the default SNAN or OPERR results when the exceptions were disabled. With the MC68060, as with the MC68881/882, SNAN and OPERR are entirely maskable since the default trap disabled results are provided by floating-point hardware.



MC68060 Software Package

M68060FPSP SNAN and OPERR exception handlers, `_fjsp_snan` and `_fjsp_operr`, will be provided for SNAN and OPERR enabled exceptions for the following reasons:

- For opclass two pre-instruction exceptions using a single or double source format with an infinity, denorm, NAN, or zero source operand, the processor does not create the correct extended-precision value for the FSAVE frame. The MC68060FPSP handlers convert the value in the FSAVE frame to extended-precision format before passing control to the user enabled SNAN or OPERR exception handlers (`_real_{snan,operr}`). No parameters are passed to the user enabled SNAN or OPERR exception handlers from the M68060FPSP package since the package provides the illusion that it never existed.
- For opclass three post-instruction exceptions, the processor does not store the default result to the destination memory or integer data register before taking the enabled exception. The MC68881/882 stored the default result in this scenario. Therefore, to maintain compatibility, the M68060FPSP SNAN and OPERR exception handlers calculate and store the default result before passing control to the user enabled SNAN and OPERR exception handlers (`_real_{snan,operr}`). No parameters are passed to the user SNAN or OPERR exception handlers since the M68060FPSP provides the illusion that it never existed.

A simple pseudo-code diagram for the SNAN and OPERR handlers is provided in the code sequence shown in Figure C-8.

```

_fjsp_{snan,operr}() {
  if ((opclass == 0) || (opclass == 2)) {
    /*
     * if src operand is a sgl or dbl
     * zero, NAN, denorm, or infinity,
     * fix operand in FSAVE frame.
     */
    fix_FSAVE_op();

    bra.l _real_{snan,operr}();
  }
  else { /* opclass 3 */
    /*
     * save default result to memory
     * or integer register file.
     */
    save_default_result();

    bra.l _real_{snan,operr}();
  }
}

```

Figure C-8. SNAN/OPERR Exception Handler Pseudo-Code

C.3.2.3.3 Inexact Exception. Opclass zero and two exception instructions taking the inexact exception cause pre-instruction exceptions, and opclass three instructions cause post-instruction inexact exceptions. The processor takes exception vector number forty-nine for the inexact exception. The FSAVE frame for the exception is valid and contains the source operand converted to extended precision.

The inexact exception is a maskable exception on the MC68060 for the trap-disabled case. The floating-point hardware produces the correct result when the inexact exception enable



bit is clear in the FPCR. Therefore, no software assistance is required in this case to maintain MC68881/882 compatibility. An M68060FPSP handler, `_fjsp_inex`, is provided for enabled inexact exceptions for the following reasons:

- For oclass two pre-instruction exceptions, the processor does not store the default result to the destination floating-point register before taking the enabled inexact exception. The MC68881/882 stored the default result in this scenario. Therefore, to maintain compatibility, the M68060FPSP inexact exception handler calculates and stores the default result before passing control to the user enabled inexact exception handler (`_real_inex`). No parameters are passed to the user enabled inexact exception handler since the M68060FPSP handler provides the illusion that it never existed.
- In addition, for oclass two pre-instruction exceptions using a single or double source format with an infinity, denorm, or zero source operand, the processor does not create the correct extended-precision value for the FSAVE frame. The correct extended-precision value is also not created when the source format is a longword integer. The M68060FPSP inexact handler converts the value in the FSAVE frame to extended-precision format for these cases before passing control to the user enabled inexact exception handler (`_real_inex`).
- For oclass three post-instruction exceptions, the processor does not store the default result to the destination memory or integer data register before taking the enabled inexact exception. The MC68881/882 stored the default result in this scenario. Therefore, to maintain compatibility, the M68060FPSP inexact exception handler calculates and stores the default result before passing control to the user enabled inexact exception handler (`_real_inex`). No parameters are passed to the user enabled inexact exception handler since the M68060FPSP handler provides the illusion that it never existed.

C.3.2.3.4 Divide-by-Zero Exception. Only oclass zero and two instructions can take the divide-by-zero floating-point (DZ) exception. The processor takes exception vector number fifty with a type zero stack frame for this case. The FSAVE frame for the DZ exception is valid and contains the source operand converted to extended precision.

The divide-by-zero exception is a maskable exception on the MC68060 for the trap disabled case. The FPU produces the correct result when the DZ bit in the FPCR is clear. No M68060FPSP assistance is required to maintain MC68881/882 compatibility for DZ disabled. A handler, `_fjsp_dz`, is provided for enabled DZ exceptions. This M68060FPSP handler converts the FSAVE source operand to extended precision if the source operand is a zero in single or double format. The handler then passes control to the user enabled divide-by-zero exception handler (`_real_dz`). No parameters are passed to the user DZ exception handler from the M68060FPSP package since the package provides the illusion that it never existed.

C.3.2.3.5 Branch/Set on Unordered Exception. The MC68060 processor provides the correct results and actions for both the branch/set on unordered (BSUN) exception enabled and disabled cases. Therefore, no M68060FPSP assistance is required for MC68881/882 compatibility.



C.3.2.4 EXCEPTIONS DURING EMULATION. Unimplemented data type, unimplemented effective address, and unimplemented floating-point instruction exception software emulation by the M68060FPSP may determine that the instruction being emulated should take a BSUN, SNAN, OPERR, OVFL, UNFL, DZ, or INEX exception. These exceptions may either be enabled or disabled (see examples in Figure C-9).

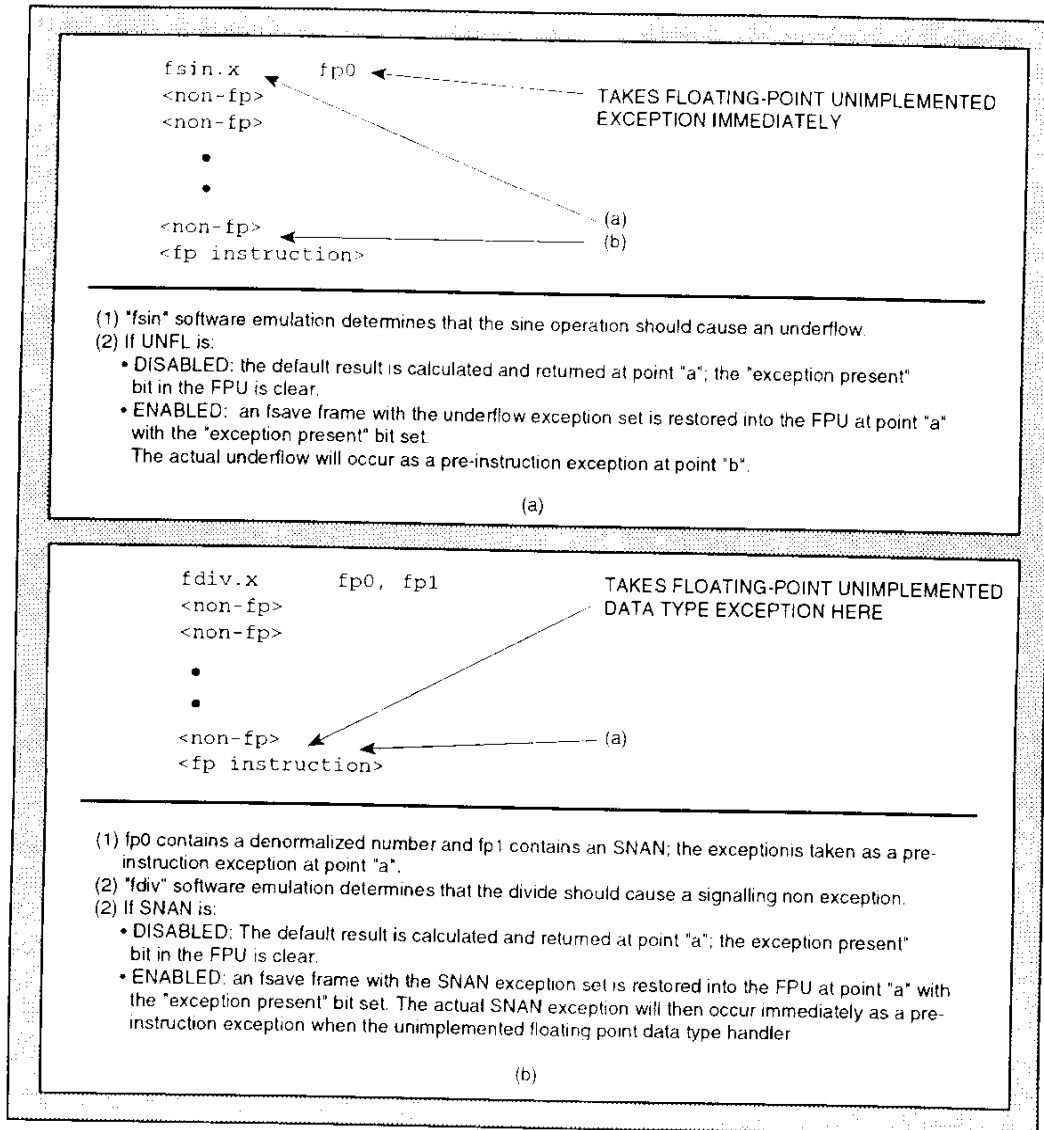

Figure C-9. Disabled vs. Enabled Exception Actions

C.3.2.4.1 Trap-Disabled Operation. If a newly found exception is disabled by the user, then the default result for that exception is returned as the result of emulation by the M68060FPSP. The handler then returns the processor to normal processing.

For example, the FSIN operation in Figure C-9(a) will take an unimplemented floating-point instruction exception. If FSIN emulation discovers that the result should cause an underflow, and underflow is disabled, then the fp0 register is assigned the default underflow result value before program execution continues to the next integer or floating-point instruction.

Note

A “true” pre-instruction exception solution would have inserted an FSAVE frame of type underflow into the FPU so that the underflow processing would be delayed until the next floating-point instruction triggered a pre-instruction underflow exception. The approach taken by the M68060FPSP in this case avoids the overhead of the second exception.

C.3.2.4.2 Trap-Enabled Operation. If an exception is enabled and the instruction is of oclass zero or two, then an FSAVE frame of that exception type is restored into the FPU by the M68060FPSP. Second, the stack frame is cleaned up to the point just before the original exception handler was entered. Next, the original exception stack frame is converted to a stack frame for the new exception type. Finally, the handler returns the processor to normal processing. The new exception is then taken as a pre-instruction exception upon encountering the next floating-point instruction.

From the previous FSIN example of Figure C-9(a), if the emulation encountered an underflow condition and underflow was enabled, an FSAVE frame with the underflow exception bit set would be inserted into the FPU. An underflow pre-instruction exception would then be taken upon encountering the next floating-point instruction.

This restoring procedure is used for enabled exceptions so that an exception will not enter through an unimplemented data type, unimplemented effective address, or unimplemented floating-point instruction exception and then exit through an SNAN, OPERR, OVFL, UNFL, DZ, or INEX exception handler for an oclass zero or two instruction. Some operating systems may be confused by this type of flow change.

Oclass three instruction emulation that encounters an enabled exception is physically unable to insert the appropriate exception frame into the FPU and return to normal processing to await the next floating-point instruction. So, the M68060FPSP converts the existing exception stack frame to a frame of the enabled exception’s type and inserts the exceptional state into the FPU with an FRESTORE. Then, the M68060FPSP package branches to the appropriate host operating system-supplied interface (`_real_{SNAN, OPERR, OVFL, UNFL, INEX}`) for the enabled exception. This approach was also used with the MC68040FPSP.

C.3.3 Module 4: Partial Floating-Point Kernel

This module is identical to the full floating-point kernel in every aspect with the exception that the floating-point unimplemented exception handler code is not included. This module is typically used with the floating-point library in a system that does not encounter MC68881 instructions that are unimplemented in the MC68060.



C.3.4 Module 5: Floating-Point Library (M68060FPLSP)

The M68060SP provides a library version of the unimplemented general monadic and dyadic floating-point instructions shown in Table C-3. These routines are System V ABI compliant as well as IEEE exception-reporting compliant. They are not, however, UNIX exception-reporting compliant. This library implementation can be compiled with user applications desiring the functionality of these instructions without having to incur the overhead of the floating-point unimplemented instruction exception. The floating-point library contains floating-point instructions that are implemented by the MC68060. The floating-point library requires the partial floating-point kernel or full floating-point kernel to be ported to the system for proper operation.

In addition, the FABS, FADD, FDIV, FINT, FINTRZ, FMUL, FNEG, FSQRT, and FSUB functions are provided for the convenience of older compilers that make subroutine calls for all floating-point instructions. The code does *not* emulate these instructions in integer, but rather simply executes them.

All input variables must be pushed onto the stack prior to calling the supplied library routine. For each function, three entry points are provided, each accepting one of the three possible input operand data types: single, double, and extended precision. For dyadic operations both input operands are defined to have the same operand data type. For instance, for a monadic instruction such as the FSIN instruction, the functions are: `_fsins`(single-precision input operand), `_fsind`(double-precision input operand), `_fsinx`(extended-precision input operand). For dyadic operations such as the FDIV instruction, the entry points provided are: `_fdivs`(both single-precision input operands), `_fdivd`(both double-precision input operands), `_fdivx`(both extended-precision input operands).

To properly call a monadic subroutine, the calling routine must push the input operand onto the stack first. For instance:

```
* This example replaces the "fsin.x fp1,fp0" instruction
* Note that _fsinx is actually implemented as an offset from the
* top of the Floating-point Library Module.
fmove.x fp1,-(sp) ; push operand to stack
bsr     _fsinx    ; result returned in fp0
add.w   #12,sp   ; clean up stack
```

To properly call a dyadic subroutine, the calling routine must push the second operand onto the stack before pushing the first operand onto the stack. For instance:

```
* This example replaces the "fdiv.x fp1,fp0" instruction
* Note that _fdivx is actually implemented as an offset from the
* top of the Floating-point Library Module.
fmove.x fp1,(sp) ; push 2nd operand to stack
fmove.x fp0,-(sp) ; push 1st operand to stack
bsr     _fdivx   ; result returned in fp0
add.w   #24,sp  ; clean up stack
```

All routines return the operation result in the register fp0. It is the responsibility of the calling routine to remove the input operands from the stack after the routine has been executed. The result's rounding precision and mode, as well as exception reporting, is dictated by the value of the FPCR upon subroutine entry. The floating-point status register (FPSR) is set



appropriately upon subroutine return. The floating-point address register (FPIAR) is undefined.

This module contains no operating system dependencies. There is no call-out dispatch table. To report an exception, the emulation routine uses the FPCR exception enable byte to determine whether or not to report an exception. If the exception is enabled, the exception is forced using implemented floating-point instructions.

For instance, if the instruction being emulated should cause a floating-point OPERR exception, then the library routine, as its last instruction, executes an FMJL of a zero and infinity to force an OPERR exception. Although the exception stack frame will not point to the correct instruction, the user can record that such an event occurred.

C.4 OPERATING SYSTEM DEPENDENCIES

When porting the unimplemented integer, full or partial floating-point kernel modules, some routines need to be written outside and are not provided by the M68060SP.

C.4.1 Instruction and Data Fetches

In traditional UNIX systems, portability is promoted by the abstracting of reads/writes from and to user space into calls to the routines `_copyin` and `_copyout` see Table C-5. The MC68040FPSP provided one higher level of abstraction with the routines `_mem_read` and `_mem_write`. These routines were a superset of the UNIX routines in that they handled both user and supervisor accesses Figure C-10.

Table C-5. UNIX Operating System Calls

Function Call	Parameters
<code>copyin</code>	<code>(user_addr, super_addr, nbytes)</code>
<code>copyout</code>	<code>(super_addr, user_addr, nbytes)</code>

```
void mem_read(src_addr, dst_addr, nbytes) {
  if (SR[supervisor_bit]) {
    /* supervisor mode */
    while (nbytes--) {
      mem[dst_addr+nbytes] = mem[src_addr+nbytes];
    }
  }
  else /* user mode */
    _copyin(src_addr, dst_addr, nbytes);
}
```

Figure C-10. `_mem_read` Pseudo-Code

This approach provided a high degree of portability for the MC68040FPSP. The installer simply had to replace the references to `_copy{in,out}` in `_mem_{read,write}` with the host operating system's (UNIX or non-UNIX) corresponding calls. In addition, any pre-processing necessary before a potential read/write fault (user or supervisor) was confined to these routines. As a result, several operating system types could be supported with only minor modifications.



MC68060 Software Package

Since the MC68040FPSP obtained most of its necessary information from the complex stack frames, very few calls to `_mem_{read,write}` were required. For the M68060SP, less information is provided by the processor. Therefore, several accesses to/from user code and data space may be necessary for emulation. Providing the MC68040FPSP level of sub-routine abstraction in the M68060SP will slightly degrade performance.

In order to compensate for this loss, the M68060SP adds to the list of operating system-supplied call-outs that read/write user/supervisor data/instruction memory. The current routines are `_imem_read_{word,long}` and `_dmem_{read,write}_{byte,word,long}`. These provide a finer granularity than the traditional `_mem_{read,write}` which is also provided. Figure C-11 outlines the register usage of these routines.

Unlike the MC68040, which stored all necessary operands and decoding information on the stack, the MC68060 processor does not always “touch” the entire instruction and operand before entering an exception handler. Therefore, unlike with the MC68040FPSP, the M68060SP memory read and write routines may encounter bad addresses. For example, the instruction `FSIN.x ADDR,fp0` will enter the M68060SP. When the M68060SP package executes a `_dmem_read` to fetch the extended-precision operand, the routine may return a failing value if `ADDR` points to inappropriate memory.

If `_mem_{read,write}` returns a non-zero status value to the M68060SP, the M68060SP creates an access error exception stack frame out of the existing exception stack frame and branches to the user-supplied call-out `_real_access`. The `_real_access` call-out must contain the actual access error handler, a short program that examines the vector table to find the actual access error handler address and branch to it, or an entirely separate access error handler for this specific case.

The PC on the access error stack frame points to the instruction that caused the original exception. The stacked address will point to the address passed to `_mem_{read,write}` before it returned a failing value. The stacked fault status long word (FSLW) will have the SEE bit set. The other FSLW bits may or may not be defined, depending on the M68060SP release. The initial release of the M68060SP does not define the other FSLW bits. However, future releases may define these bits. The handler supplied by the operating system for `_real_access` (most likely the system's access error handler) should check for this bit and take appropriate action if set. An example action could be that the process executing the instruction that originally entered the M68060SP is terminated.



```

* _dmem_write():
* Writes to data memory while in supervisor mode.
* INPUTS:
*   a0 - supervisor source address
*   a1 - user destination address
*   d0 - number of bytes to write
*   $4(a6),bit5 - 1 = supervisor mode, 0 = user mode
* OUTPUTS:
*   d1 - 0 = success, !0 = failure

*_imem_read(), _dmem_read():
* Reads from data/instruction memory while in supervisor mode.
* INPUTS:
*   a0 - user source address
*   a1 - supervisor destination address
*   d0 - number of bytes to read
*   $4(a6),bit5 - 1 = supervisor mode, 0 = user mode
* OUTPUTS:
*   d1 - 0 = success, !0 = failure

*_dmem_read_byte(), _dmem_read_word(), _dmem_read_long():
* Read a data byte/word/long from user memory.
* INPUTS:
*   a0 - user source address
*   $4(a6),bit5 - 1 = supervisor mode, 0 = user mode
* OUTPUTS:
*   d0 - data byte/word/long in d0
*   d1 - 0 = success, !0 = failure

*_dmem_write_byte(), dmem_write_word(), dmem_write_long():
* Write a data byte/word/long to user memory.
* INPUTS:
*   a0 - user destination address
*   d0 - data byte/word/long in d0
*   $4(a6),bit5 - 1 = supervisor mode, 0 = user mode
* OUTPUTS:
*   d1 - 0 = success, !0 = failure

*_imem_read_word(), _imem_read_long():
* Read an instruction word/long from user memory.
* INPUTS:
*   a0 - user source address
*   $4(a6),bit5 - 1 = supervisor mode, 0 = user mode
* OUTPUTS:
*   d0 - instruction word/long in d0
*   d1 - 0 = success, !0 = failure

```

Figure C-11. Register Usage of {i,d}mem_{read,write}_{b,w,l}



C.4.2 Instructions Not Recommended

Emulated instructions that use the pre-decrement and post-increment addressing mode on the system stack must not contradict the basic definition of a stack. An operation that uses input operands below the stack (using the pre-decrement addressing mode) exhibits poor programming structure since the instruction is using a value before it has been defined. In addition, instructions that place a result on the stack using the post-increment addressing mode exhibit poor programming structure since an unexpected exception such as an interrupt or an unimplemented instruction exception would corrupt the result. The M68060SP does not handle these instruction cases properly, and unpredictable behavior will be exhibited when executing code of this type.

The M68060SP does not recover gracefully from these instruction cases because a performance penalty would be incurred to handle them properly. To avoid imposing this performance penalty on well-behaved systems, the task of avoiding these cases has been left outside the M68060SP. If the system absolutely requires that these cases be handled gracefully, the system software envelope can pre-filter these cases prior to entering the M68060SP. Table C-6 outlines these instructions.

Table C-6. Instructions Not Handled by the M68060SP

Instruction	Exception	Address Mode
div{u,s}.l (64-bit)	Integer Unimplemented	-(ssp), dr:dq
mul{u,s}.l (64-bit)	Integer Unimplemented	-(ssp), dr:dq
cas.{w,l} (mis)	Integer Unimplemented	dc:du, -(ssp)
cas.{w,l} (mis)	Integer Unimplemented	dc:du, (ssp)+
f<op>.p (all)	Floating-Point Unimplemented Data Type	-(ssp), fpn
f<op>.p	Floating-Point Unimplemented Data Type	fpn, (ssp)+
f<op> {b,w,l,s,d,x}	Floating-Point Unimplemented Instruction	-(ssp), fpn
fs<cc>.b	Floating-Point Unimplemented Instruction	-(ssp)
fmovem.x	Floating-Point Unimplemented Instruction	-(ssp), dn
fmovem.x	Floating-Point Unimplemented Instruction	dn, (ssp)+
f<op>.x	Underflow, SNAN	fpn, (ssp)+
f<op>.{b,w,l}	Enabled OPERR	fpn, (ssp)+



C.5 INSTALLATION NOTES

This section provides a guide on how to install the M68060SP. The files provided in an M68060SP release are shown on Table C-7.

Table C-7. Files Provided in an M68060SP Release

File	Description
fpsp.sa	Full floating-point kernel module
pfpsp.sa	Partial floating-point kernel module
isp.sa	Integer unimplemented exception handler module
fplsp.sa	Floating-point library module
ilsp.sa	Integer library module
fskeleton.s	Sample call-outs needed by fpsp.sa and pfpsp.sa
iskeleton.s	Sample call-outs needed by isp.sa
os.s	Sample call-outs needed by fpsp.sa, pfpsp.sa and isp.sa
fpsp.doc	Release documentation for fpsp.sa and pfpsp.sa
isp.doc	Release documentation for isp.sa
fplsp.doc	Release documentation for fplsp.sa
ilsp.doc	Release documentation for ilsp.sa
fpsp.s	Source code of fpsp.sa
pfpsp.s	Source code of pfpsp.sa
isp.s	Source code of isp.sa
fplsp.s	Source code of fplsp.sa
ilsp.s	Source code of ilsp.sa

C.5.1 Installing the Library Modules

The integer and floating-point library modules (files ilsp.sa and fplsp.sa) require a very simple installation procedure. A symbolic label needs to be added to the module top so that calling routines can use this to reference the other entry-points supplied by these modules as an offset from the top of the module. It is the responsibility of the calling routine to enter the package through the proper offset relative to the top of the module.

C.5.2 Installing the Kernel Modules

The unimplemented integer instruction exception handler and full and/or partial floating-point kernel modules (files fpsp.sa, isp.sa, pfpsp.sa) may require additional steps. To aid in installation, three assembly language files are made available in the M68060SP release. These files contain the sample call-out routines and call-out dispatch tables for the unimplemented integer instruction exception handler module (iskeleton.s file), full or partial floating-point kernel modules (fskeleton.s file), and call-outs common to both (os.s file). When mod-



MC68060 Software Package

ifying the call-out dispatch table, keep in mind that these need to be supplied and filled-in with **module-relative**, and not absolute addresses.

The next step is to prepare the exception vector table. The appropriate vector table entries must be filled with the addresses of the appropriate entry points. Since the modified pseudo-assembly module contains symbols that indicate the top of the module, the appropriate vector table entries must contain the symbol of the appropriate module top plus the pre-defined offset. Another alternative is to use the module code size information given in Table C-1 to concatenate the modules and use a single symbolic label to describe the combined module. Figure C-12 illustrates the relationship of the vector table to the M68060SP.

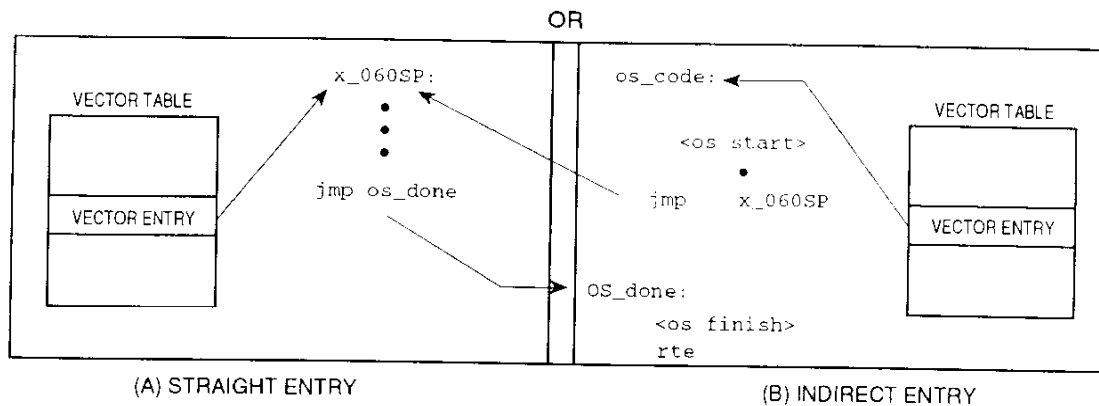

NOTE: X_060SP represents a generic M68060SP handler entry point and is not intended to imply a single shared handler entry point for all MC68060 exception handlers.

Figure C-12. Vector Table and M68060SP Relationship

The last step is to link everything. Be aware that the files must be linked such that the parts of the module that are in different files are kept together. Be aware that the included files are for a very simple installation procedure and may not be appropriate for all systems. For instance, the supplied `_real_trace` routine would be inappropriate for a system in which the trace vector table entry is dynamically changed. For that system, the `_real_trace` routine must include vector table query before jumping to the actual trace routine.

C.5.3 Release Notes and Module Offset Assignments

To obtain the most up-to-date offset assignments for the call-out dispatch table and the module Entry-point Dispatch Section assignments, four document files are provided with the M68060SP release. The files `isp.doc`, `ilsp.doc`, `fbsp.doc`, and `fplsp.doc` define the offsets for the unimplemented integer instruction exception handler, unimplemented integer subroutine, full (or partial) floating-point kernel and floating-point library modules respectively. The current module sizes are shown in Table C-1. If a module increases in code size or if additional entry points are made available in future releases, they will be documented in these four files.



C.5.4 AESOP Electronic Bulletin Board

Motorola's AESOP electronic bulletin board contains the most current release of the M68060SP, as well as older releases of the M68060SP. The source code used to create the five pseudo-assembly files is provided for documentation purposes only and should not be used for generating a customized software package. Doing so would create versions of the package that is untested and unsupported by Motorola. Motorola will not create an assembly-to-assembly conversion software to provide a different assembler syntax than is already available. AESOP requires VT100 terminal emulation, 9600 Baud, 8 bits, no parity, and 1 stop bit. The modem supports V.32bis and V.42bis and MNP5 protocols. The kermit protocol is needed to download from AESOP. AESOP can be reached at (800)843-3451 or (512)891-3650.



APPENDIX D MC68060 INSTRUCTIONS

This appendix provides a quick reference to instructions of the MC68060 that differ in description to the instruction description found in the *M68000 Family Programmer's Reference Manual* (M68000PM/AD).

To provide a quick summary of which instructions require software assistance from the M68060 software package (M68060SP), and to indicate differences of the MC68060 relative to earlier members of the M68000 family, Table D-1 is provided. Table A-2 lists the M68000 family instructions by mnemonics followed by the descriptive name. Table D-3 provides all assigned vector table entries up to, and including the MC68060. This may be useful for writing handlers that apply to multiple members of the M68000 family of processors.

Since some of the MC68060 instructions require software-assist from the MC68060SP, it is assumed that the MC68060SP has already been installed properly in the system. Given this assumption, most of the description found in the *M68000 Family Programmer's Reference Manual* applies to the MC68060. In general, instruction descriptions that apply to the M68000 family, MC68040 or M68040FPSP apply also to the MC68060 or MC68060SP, unless otherwise provided in this appendix.

Table D-1. M68000 Family Instruction Set and Processor Cross-Reference

Mnemonic	MC68000/ MC68008	MC68010	MC68020	MC68030	MC68040	MC68060	MC68881/ MC68882	MC68851	CPU32
ABCD	X	X	X	X	X	X			X
ADD	X	X	X	X	X	X			X
ADDA	X	X	X	X	X	X			X
ADDI	X	X	X	X	X	X			X
ADDQ	X	X	X	X	X	X			X
ADDX	X	X	X	X	X	X			X
AND	X	X	X	X	X	X			X
ANDI	X	X	X	X	X	X			X
ANDI to CCR	X	X	X	X	X	X			X
ANDI to SR ¹	X	X	X	X	X	X			X
ASL, ASR	X	X	X	X	X	X			X
Bcc	X	X	X	X	X	X			X
BCHG	X	X	X	X	X	X			X
BCLR	X	X	X	X	X	X			X
BFCHG			X	X	X	X			
BFCLR			X	X	X	X			
BFEXTS			X	X	X	X			
BFEXTU			X	X	X	X			
BFFFO			X	X	X	X			



Freescale Semiconductor, Inc.

MC68060 Instructions

Table D-1. M68000 Family Instruction Set and Processor Cross-Reference (Continued)

Mnemonic	MC68000/ MC68008	MC68010	MC68020	MC68030	MC68040	MC68060	MC68881/ MC68882	MC68851	CPU32
BFINS			X	X	X	X			
BFSET			X	X	X	X			
BFTST			X	X	X	X			
BGND									
BKPT		X	X	X	X	X			X
BRA	X	X	X	X	X	X			X
BSET	X	X	X	X	X	X			X
BSR	X	X	X	X	X	X			X
BTST	X	X	X	X	X	X			X
CALLM			X						
CAS, CAS2			X	X	X	X,3			
CHK	X	X	X	X	X	X			X
CHK2			X	X	X	3			X
CINV ¹					X	X			
CLR	X	X	X	X	X	X			X
CMP	X	X	X	X	X	X			X
CMPA	X	X	X	X	X	X			X
CMP1	X	X	X	X	X	X			X
CMPM	X	X	X	X	X	X			X
CMP2			X	X	X	3			X
cpBcc			X	X					
cpDBcc			X	X					
cpGEN			X	X					
cpRESTORE ¹			X	X					
cpSAVE ¹			X	X					
cpScc			X	X					
cpTRAPcc			X	X					
CPUSH ¹					X	X			
DBcc	X	X	X	X	X	X			X
DIVS	X	X	X	X	X	X,3			X
DIVSL			X	X	X	X			X
DIVU	X	X	X	X	X	X,3			X
DIVUL			X	X	X	X			X
EOR	X	X	X	X	X	X			X
EORI	X	X	X	X	X	X			X
FORI to CCR	X	X	X	X	X	X			X
EORI to SR ¹	X	X	X	X	X	X			X
EXG	X	X	X	X	X	X			X
EXT	X	X	X	X	X	X			X
EXTB			X	X	X	X			X
FABS					X,2	X,2	X		
FSABS, FDABS					X,2	X,2			
FACOS					2,3	2,3	X		
FADD					X,2	X,2	X		
FSADD, FDADD					X,2	X,2			
FASIN					2,3	2,3	X		



Table D-1. M68000 Family Instruction Set and Processor Cross-Reference (Continued)

Mnemonic	MC68000/ MC68008	MC68010	MC68020	MC68030	MC68040	MC68060	MC68881/ MC68882	MC68851	CPU32
FATAN					2,3	2,3	X		
FATANH					2,3	2,3	X		
FBcc					X,2	X,2	X		
FCMP					X,2	X,2	X		
FCOS					2,3	2,3	X		
FCOSH					2,3	2,3	X		
FDBcc					X,2	2,3	X		
FDIV					X,2	X,2	X		
FSDIV, FDDIV					X,2	X,2			
FETOX					2,3	2,3	X		
FETOXM1					2,3	2,3	X		
FGETEXP					2,3	2,3	X		
FGETMAN					2,3	2,3	X		
FINT					2,3	X,2	X		
FINTRZ					2,3	X,2	X		
FLOG10					2,3	2,3	X		
FLOG2					2,3	2,3	X		
FLOGN					2,3	2,3	X		
FLOGNP1					2,3	2,3			
FMOD					2,3	2,3	X		
FMOVE					X,2	X,2	X		
FSMOVE, FDMOVE					X,2	X,2			
FMOVECR					2,3	2,3	X		
FMOVEM					X,2	X,2,3	X		
FMUL					X,2	X,2	X		
FSMUL, FDMUL					X,2	X,2			
FNEG					X,2	X,2	X		
FSNEG, FDNEG					X,2	X,2			
FNOP					X,2	X,2	X		
FREM					2,3	2,3	X		
FRESTORE ¹					X,2	X,2	X		
FSAVE*					X,2	X,2	X		
FSCALE					2,3	2,3	X		
FScc					X,2	2,3	X		
FSGLDIV					2,3	2,3	X		
FSGLMUL					2,3	2,3	X		
FSIN					2,3	2,3	X		
FSINCOS					2,3	2,3	X		
FSINH					2,3	2,3	X		
FSQRT					X,2	X,2	X		
FSSQRT, FDSQRT					X,2	X,2			
FSUB					X,2	X,2	X		
FSSUB, FDSUB					X,2	X,2			
FTAN					2,3	2,3	X		
FTANH					2,3	2,3	X		



MC68060 Instructions

Table D-1. M68000 Family Instruction Set and Processor Cross-Reference (Continued)

Mnemonic	MC68000/ MC68008	MC68010	MC68020	MC68030	MC68040	MC68060	MC68881/ MC68882	MC68851	CPU32
FTENTOX					2,3	2,3	X		
FTRAPcc					X,2	2,3	X		
FTST					X,2	X,2	X		
FTWOTOX					2,3	2,3	X		
ILLEGAL	X	X	X	X	X	X			X
JMP	X	X	X	X	X	X			X
JSR	X	X	X	X	X	X			X
LEA	X	X	X	X	X	X			X
LINK	X	X	X	X	X	X			X
LPSTOP									X
LSL,LSR	X	X	X	X	X	X			X
MOVE	X	X	X	X	X	X			X
MOVEA	X	X	X	X	X	X			X
MOVE from CCR		X	X	X	X	X			X
MOVE to CCR	X	X	X	X	X	X			X
MOVE from SR ¹	4	X	X	X	X	X			X
MOVE to SR ¹	X	X	X	X	X	X			X
MOVE USP ¹	X	X	X	X	X	X			X
MOVE16					X	X			
MOVEC ¹		X	X	X	X	X			X
MOVEM	X	X	X	X	X	X			X
MOVEP	X	X	X	X	X				X
MOVEQ	X	X	X	X	X	X			X
MOVES ¹		X	X	X	X	X			X
MULS	X	X	X	X	X	X,3			X
MULU	X	X	X	X	X	X,3			X
NBCD	X	X	X	X	X	X			X
NEG	X	X	X	X	X	X			X
NEGX	X	X	X	X	X	X			X
NOP	X	X	X	X	X	X			X
NOT	X	X	X	X	X	X			X
OR	X	X	X	X	X	X			X
ORI	X	X	X	X	X	X			X
ORI to CCR	X	X	X	X	X	X			X
ORI to SR ¹	X	X	X	X	X	X			X
PACK			X	X	X	X			
PBcc ¹								X	
PDBcc ¹								X	
PEA	X	X	X	X	X	X			X
PFLUSH ¹				X,5	X	X		X	
PFLUSHA ¹				X,5				X	
PFLUSHR ¹								X	
PFLUSHS ¹								X	
PLPA						X			



Table D-1. M68000 Family Instruction Set and Processor Cross-Reference (Continued)

Mnemonic	MC68000/ MC68008	MC68010	MC68020	MC68030	MC68040	MC68060	MC68881/ MC68882	MC68851	CPU32
PLOAD ¹				X,5				X	
PMOVE ¹				X				X	
PRESTORE ¹								X	
PSAVE ¹								X	
PScC ¹								X	
PTEST ¹				X	X			X	
PTRAPcc ¹								X	
PVALID								X	
RESET ¹	X	X	X	X	X	X			X
ROL,ROR	X	X	X	X	X	X			X
ROXL, ROXR	X	X	X	X	X	X			X
RTD		X	X	X	X	X			X
RTE ¹	X	X	X	X	X	X			X
RTM			X						
RTR	X	X	X	X	X	X			X
RTS	X	X	X	X	X	X			X
SBCD	X	X	X	X	X	X			X
ScC	X	X	X	X	X	X			X
STOP ¹	X	X	X	X	X	X			X
SUB	X	X	X	X	X	X			X
SUBA	X	X	X	X	X	X			X
SUBI	X	X	X	X	X	X			X
SUBQ	X	X	X	X	X	X			X
SUBX	X	X	X	X	X	X			X
SWAP	X	X	X	X	X	X			X
TAS	X	X	X	X	X	X			X
TBLS, TBLSN									X
TBLU, TBLUN									X
TRAP	X	X	X	X	X	X			X
TRAPcc			X	X	X	X			X
TRAPV	X	X	X	X	X	X			X
TST	X	X	X	X	X	X			X
UNLK	X	X	X	X	X	X			X
UNPK			X	X	X	X			

NOTES:

1. Privileged (Supervisor) Instruction
2. Not applicable to the MC68EC040, MC68LC040, MC68EC060, and MC68LC060.
3. These are software-supported instructions on the MC68040 and MC68060.
4. This instruction is not privileged for the MC68000 and MC68008.
5. Not applicable to MC68EC030.
6. All MC68060 and MC68040 Floating-point instructions require software assistance for unimplemented data types (MC68040 and MC68060) and unimplemented effective addresses (MC68060 only).



Table D-2. M68000 Family Instruction Set

Mnemonic	Description
ABCD	Add Decimal with Extend
ADD	Add
ADDA	Address
ADDI	Add Immediate
ADDQ	Add Quick
ADDX	Add with Extend
AND	Logical AND
ANDI	Logical AND Immediate
ANDI to CCR	AND Immediate to Condition Code Register
ANDI to SR	AND Immediate to Status Register
ASL, ASR	Arithmetic Shift Left and Right
Bcc	Branch Conditionally
BCHG	Test Bit and Change
BCLR	Test Bit and Clear
BFCHG	Test Bit Field and Change
BFCLR	Test Bit Field and Clear
BFEXTS	Signed Bit Field Extract
BFEXTU	Unsigned Bit Field Extract
BFFFO	Bit Field Find First One
BFINS	Bit Field Insert
BFSET	Test Bit Field and Set
BFTST	Test Bit Field
BGND	Enter Background Mode
BKPT	Breakpoint
BRA	Branch
BSET	Test Bit and Set
BSR	Branch to Subroutine
BTST	Test Bit
CALLM	CALL Module
CAS	Compare and Swap Operands
CAS2	Compare and Swap Dual Operands
CHK	Check Register Against Bound
CHK2	Check Register Against Upper and Lower Bounds
CINV	Invalidate Cache Entries
CLR	Clear
CMP	Compare
CMPA	Compare Address
CMPI	Compare Immediate
CMPM	Compare Memory to Memory
CMP2	Compare Register Against Upper and Lower Bounds
cpBcc	Branch on Coprocessor Condition
cpDBcc	Test Coprocessor Condition Decrement and Branch
cpGEN	Coprocessor General Function
cpRESTORE	Coprocessor Restore Function
cpSAVE	Coprocessor Save Function
cpScc	Set on Coprocessor Condition
cpTRAPcc	Trap on Coprocessor Condition
DBcc	Test Condition, Decrement and Branch
DIVS, DIVSL	Signed Divide
DIVU, DIVUL	Unsigned Divide
EOR	Logical Exclusive-OR
EORI	Logical Exclusive-OR Immediate
EORI to CCR	Exclusive-OR Immediate to Condition Code Register
EORI to SR	Exclusive-OR Immediate to Status Register
EXG	Exchange Registers
EXT, EXTB	Sign Extend



Table D-2. M68000 Family Instruction Set (Continued)

Mnemonic	Description
FABS	Floating-Point Absolute Value
FSFABS, FDFABS	Floating-Point Absolute Value (Single/Double Precision)
FACOS	Floating-Point Arc Cosine
FADD	Floating-Point Add
FSADD, FDADD	Floating-Point Add (Single/Double Precision)
FASIN	Floating-Point Arc Sine
FATAN	Floating-Point Arc Tangent
FATANH	Floating-Point Hyperbolic Arc Tangent
FBcc	Floating-Point Branch
FCMP	Floating-Point Compare
FCOS	Floating-Point Cosine
FCOSH	Floating-Point Hyperbolic Cosine
FDBcc	Floating-Point Decrement and Branch
FDIV	Floating-Point Divide
FSDIV, FDDIV	Floating-Point Divide (Single/Double Precision)
FETOX	Floating-Point e^x
FETOXM1	Floating-Point $e^x - 1$
FGETEXP	Floating-Point Get Exponent
FGETMAN	Floating-Point Get Mantissa
FINT	Floating-Point Integer Part
FINTRZ	Floating-Point Integer Part, Round-to-Zero
FLOG10	Floating-Point Log10
FLOG2	Floating-Point Log2
FLOGN	Floating-Point Loge
FLOGNP1	Floating-Point Loge ^(x+1)
FMOD	Floating-Point Modulo Remainder
FMOVE	Move Floating-Point Register
FSMOVE, FDMOVE	Move Floating-Point Register (Single/Double Precision)
FMOVECR	Move Constant ROM
FMOVEM	Move Multiple Floating-Point Registers
FMUL	Floating-Point Multiply
FSMUL, FDMUL	Floating-Point Multiply (Single/Double Precision)
FNEG	Floating-Point Negate
FSNEG, FDNeg	Floating-Point Negate (Single/Double Precision)
FNOP	Floating-Point No Operation
FREM	IEEE Remainder
FRESTORE	Restore Floating-Point Internal State
FSAVE	Save Floating-Point Internal State
FSCALE	Floating-Point Scale Exponent
FScc	Floating-Point Set According to Condition
FSGLDIV	Single-Precision Divide
FSGLMUL	Single-Precision Multiply
FSIN	Sine
FSINCOS	Simultaneous Sine and Cosine
FSINH	Hyperbolic Sine
FSQRT	Floating-Point Square Root
FSSQRT, FDSQRT	Floating-Point Square Root (Single/Double Precision)
FSUB	Floating-Point Subtract
FSSUB, FDSUB	Floating-Point Subtract (Single/Double Precision)
FTAN	Tangent
FTANH	Hyperbolic Tangent
FTENTOX	Floating-Point 10^x
FTRAPcc	Floating-Point Trap on Condition
FTST	Floating-Point Test
FTWOTOX	Floating-Point 2^x
ILLEGAL	Take Illegal Instruction Trap



Table D-2. M68000 Family Instruction Set (Continued)

Mnemonic	Description
JMP	Jump
JSR	Jump to Subroutine
LEA	Load Effective Address
LINK	Link and Allocate
LPSTOP	Low-Power Stop
LSL, LSR	Logical Shift Left and Right
MOVE	Move
MOVEA	Move Address
MOVE from CCR	Move from Condition Code Register
MOVE from SR	Move from Status Register
MOVE to CCR	Move to Condition Code Register
MOVE to SR	Move to Status Register
MOVE USP	Move User Stack Pointer
MOVE16	16-Byte Block Move
MOVEC	Move Control Register
MOVEM	Move Multiple Registers
MOVEP	Move Peripheral
MOVEQ	Move Quick
MOVES	Move Alternate Address Space
MULS	Signed Multiply
MULU	Unsigned Multiply
NBCD	Negate Decimal with Extend
NEG	Negate
NEGX	Negate with Extend
NOP	No Operation
NOT	Logical Complement
OR	Logical Inclusive-OR
ORI	Logical Inclusive-OR Immediate
ORI to CCR	Inclusive-OR Immediate to Condition Code Register
ORI to SR	Inclusive-OR Immediate to Status Register
PACK	Pack BCD
PBcc	Branch on PMMU Condition
PDBcc	Test, Decrement, and Branch on PMMU Condition
PEA	Push Effective Address
PFLUSH	Flush Entry(ies) in the ATCs
PFLUSHA	Flush Entry(ies) in the ATCs
PFLUSHR	Flush Entry(ies) in the ATCs and RPT Entries
PFLUSHS	Flush Entry(ies) in the ATCs
PLOAD	Load an Entry into the ATC
PLPA	Load Physical Address
PMOVE	Move PMMU Register
PRESTORE	PMMU Restore Function
PSAVE	PMMU Save Function
PScc	Set on PMMU Condition
PTEST	Test a Logical Address
PTRAPcc	Trap on PMMU Condition
PVALID	Validate a Pointer
RESET	Reset External Devices
ROL, ROR	Rotate Left and Right
ROXL, ROXR	Rotate with Extend Left and Right
RTD	Return and Deallocate
RTE	Return from Exception
RTM	Return from Module
RTR	Return and Restore
RTS	Return from Subroutine



Table D-2. M68000 Family Instruction Set (Continued)

Mnemonic	Description
SBCD	Subtract Decimal with Extend
SCC	Set Conditionally
STOP	Stop
SUB	Subtract
SUBA	Subtract Address
SUBI	Subtract Immediate
SUBQ	Subtract Quick
SUBX	Subtract with Extend
SWAP	Swap Register Words
TAS	Test Operand and Set
TBLS, TBLSN	Signed Table Lookup with Interpolate
TBLU, TBLUN	Unsigned Table Lookup with Interpolate
TRAP	Trap
TRAPcc	Trap Conditionally
TRAPV	Trap on Overflow
TST	Test Operand
UNLK	Unlink
UNPK	Unpack BCD



Table D-3. Exception Vector Assignments for the M68000 Family

Vector Number(s)	Vector Offset (Hex)	Assignment
0	000	Reset Initial Interrupt Stack Pointer
1	004	Reset Initial Program Counter
2	008	Access Fault
3	00C	Address Error
4	010	Illegal Instruction
5	014	Integer Divide-by-Zero
6	018	CHK, CHK2 Instruction
7	01C	FTRAPcc, TRAPcc, TRAPV Instructions
8	020	Privilege Violation
9	024	Trace
10	028	Line 1010 Emulator (Unimplemented A-Line Opcode)
11	02C	Line 1111 Emulator (Unimplemented F-Line Opcode)
12	030	(Reserved)
13	034	Coprocessor Protocol Violation (Defined for MC68020 and MC68030)
14	038	Format Error
15	03C	Uninitialized Interrupt
16–23	040–05C	(Unassigned, Reserved)
24	060	Spurious Interrupt
25	064	Level 1 Interrupt Autovector
26	068	Level 2 Interrupt Autovector
27	06C	Level 3 Interrupt Autovector
28	070	Level 4 Interrupt Autovector
29	074	Level 5 Interrupt Autovector
30	078	Level 6 Interrupt Autovector
31	07C	Level 7 Interrupt Autovector
32–47	080–0BC	TRAP #0–15 Instruction Vectors
48	0C0	Floating-Point Branch or Set on Unordered Condition (Defined for MC68881, MC68882, MC68040, and MC68060)
49	0C4	Floating-Point Inexact Result (Defined for MC68881, MC68882, MC68040, and MC68060)
50	0C8	Floating-Point Divide-by-Zero (Defined for MC68881, MC68882, MC68040, and MC68060)
51	0CC	Floating-Point Underflow (Defined for MC68881, MC68882, MC68040, and MC68060)
52	0D0	Floating-Point Operand Error (Defined for MC68881, MC68882, MC68040, and MC68060)
53	0D4	Floating-Point Overflow (Defined for MC68881, MC68882, MC68040, and MC68060)
54	0D8	Floating-Point Signaling NAN (Defined for MC68881, MC68882, MC68040, and MC68060)
55	0DC	Floating-Point Unimplemented Data Type (Defined for MC68040 and MC68060)
56	0E0	MMU Configuration Error (Defined for MC68030 and MC68851)
57	0E4	MMU Illegal Operation Error (Defined for MC68851)
58	0E8	MMU Access Level Violation Error (Defined for MC68851)
59	0EC	(Unassigned, Reserved)
60	0F0	Unimplemented Effective Address (Defined for MC68060)
61	0F4	Unimplemented Integer Instruction (Defined for MC68060)
62–63	0F8–0FC	(Unassigned, Reserved)
64–255	100–3FC	User Defined Vectors (192)



CPUSH

Push and Possibly Invalidate Cache Line

CPUSH

(MC68060, MC68LC060, MC68EC060)

Operation: If Supervisor State, Then
 If Data Cache, Then
 Push Selected Dirty Data Cache Lines
 If DPI bit of CACR = 0, Then
 Invalidate Selected Cache Lines
 Endif
 Endif
 If Instruction Cache, Then
 Invalidate Selected Cache lines
 Endif
 Endif
 Else TRAP

Assembler

Syntax: CPUSHL<cache>, (An)
 CPUSHP<cache>, (An)
 CPUSHA<cache>

Where <cache> specifies the instruction cache, data cache, both caches, or neither cache.

Attributes: Unsize

Description: Pushes and possibly invalidates selected cache lines. The data cache, instruction cache, both caches, or neither cache can be specified. When the data cache is specified, the selected data cache lines are first pushed to memory (if they contain dirty data) and then invalidated if the DPI bit of the CACR is cleared. Otherwise, the selected data cache lines remain valid. Selected instruction cache lines are invalidated. The CACR is accessed via the MOVEC instruction.

Specific cache lines can be selected in three ways:

1. CPUSHL pushes and possibly invalidates the cache line (if any) matching the physical address in the specified address register.
2. CPUSHP pushes and possibly invalidates the cache lines (if any) matching the physical memory page in the specified address register. For example, if 4K-byte page sizes are selected and An contains \$12345000, all cache lines matching page \$12345000 are selected.
3. CPUSHA pushes and possibly invalidates all cache entries.



MC68060 Instructions

CPUSH

Push and Possibly Invalidate Cache Line

(MC68060, MC68LC060, MC68EC060)

CPUSH

Condition Codes:

Not affected.

Instruction Format:

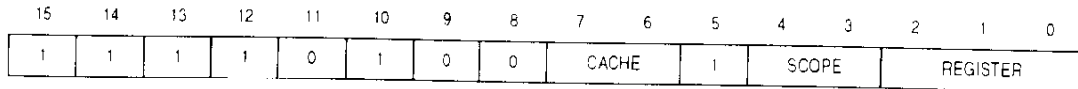

Instruction Fields:

Cache field—Specifies the Cache.

- 00—No Operation
- 01—Data Cache
- 10—Instruction Cache
- 11—Data and Instruction Caches

Scope field—Specifies the Scope of the Operation.

- 00—Illegal (causes illegal instruction trap)
- 01—Line
- 10—Page
- 11—All

Register field—Specifies the address register for line and page operations. For line operations, the low-order bits 3–0 of the address are don't care. Bits 11–0 or 12–0 of the address are don't care for 4K-byte or 8K-byte page operations, respectively.



FRESTORE

Restore Internal
Floating-Point State
(MC68060 only)

FRESTORE

Operation: If in Supervisor State
Then FPU State Frame \rightarrow Internal State
Else TRAP

**Assembler
Syntax:** FRESTORE<ea>

Attributes: Unsized

Description: Aborts the execution of any floating-point operation in progress and loads a new floating-point unit internal state from the state frame located at the effective address. The state frame always contains three long words. The third byte from of the state frame specifies the frame format. The fourth byte of the state frame contains the exception vector. If the frame format is invalid, the FRESTORE aborts, and a format exception is generated. If the frame format is valid, the state frame is loaded, starting at the specified location and proceeding through higher addresses.

The FRESTORE instruction does not normally affect the programmer's model registers of the floating-point coprocessor, except for the NULL state frame. The FRESTORE instruction is used with the FMOVEM instruction to perform a full context restoration of the floating-point unit, including the floating-point data registers and system control registers. To accomplish a complete restoration, the FMOVEM instructions are first executed to load the programmer's model, followed by the FRESTORE instruction to load the internal state.



FRESTORE

Restore Internal
Floating-Point State
(MC68060 only)

FRESTORE

The current implementation of the MC68060 supports the following four state frames:

- NULL: This state frame has a frame format of \$00. An FRESTORE operation with this state frame is equivalent to a hardware reset of the floating-point unit. The programmer's model is set to the reset state, with nonsignaling NaNs in the floating-point data registers and zeros in the floating-point control register, floating-point status register, and floating-point instruction address register. (Thus, it is unnecessary to load the programmer's model before this operation.)
- IDLE: This state frame has a frame format of \$60. An FRESTORE operation with this state frame causes the floating-point unit to be restored to the idle state, waiting for the initiation of the next instruction, with no exceptions pending. The programmer's model is not affected by loading this type of state frame.
- EXCP: This state frame has a frame format of \$E0. An FRESTORE operation with this state frame causes the floating-point unit to be restored to an exceptional state. The exception vector field defines the type of exception that is pending. When in this state, initiation of any floating-point instruction with the exception of FSAVE or another FRESTORE causes the pending exception to be taken. The floating-point unit remains in this state until an FSAVE instruction is executed, then, it enters the idle state. The programmer's model is not affected by loading this type of state frame.

Floating-Point Status Register: Cleared if the state size is NULL; otherwise, not affected.



FRESTORE

Restore Internal
Floating-Point State
(MC68060 only)

FRESTORE

Instruction Format:

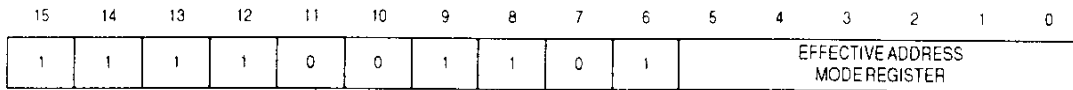

Instruction Field:

Effective Address field—Determines the addressing mode for the state frame. Only postincrement or control addressing modes can be used as listed in the following table:

Addressing Mode	Mode	Register	Addressing Mode	Mode	Register
Dn	—	—	(xxx).W	111	000
An	—	—	(xxx).L	111	001
(An)	010	reg. number:An	#<data>	—	—
(An) +	011	reg. number:An			
~(An)	—	—			
(d16,An)	101	reg. number:An	(d16,PC)	111	010
(dg,An,Xn)	110	reg. number:An	(dg,PC,Xn)	111	011
(bd,An,Xn)	110	reg. number:An	(bd,PC,Xn)	111	011
([bd,An,Xn],od)	110	reg. number:An	([bd,PC,Xn],od)	111	011
([bd,An],Xn,od)	110	reg. number:An	([bd,PC],Xn,od)	111	011



FSAVE

Save Internal Floating-Point State
(MC68060 only)

FSAVE

Operation: If in Supervisor State
Then FPU Internal State → State Frame
Else TRAP

Assembler

Syntax: FSAVE<ea>

Attributes: Unsized

Description: FSAVE allows the completion of any floating-point operation in progress. It saves the internal state of the floating-point unit in a state frame located at the effective address. After the save operation, the floating-point unit is in the idle state, waiting for the execution of the next instruction. The first long word written to the state frame contains the frame format on the third byte. The state frame always contains three long words.

Any floating-point operation in progress when an FSAVE instruction is encountered can be completed before the FSAVE executes, saving an IDLE state frame. An IDLE state frame is created by the FSAVE if no exceptions occurred; otherwise, an EXCP state frame is created.



FSAVE

Save Internal Floating-Point State (MC68060 only)

FSAVE

The following state frames apply to the MC68060.

- NULL: An FSAVE instruction that generates this state frame indicates that the floating-point unit state has not been modified since the last hardware reset or FRESTORE instruction with a NULL state frame. This indicates that the programmer's model is in the reset state, with nonsignaling NaNs in the floating-point data registers and zeros in the floating-point control register, floating-point status register, and floating-point instruction address register. (Thus, it is not necessary to save the programmer's model.)
- IDLE: An FSAVE instruction that generates this state frame indicates that the floating-point unit finished in an idle condition and is without any pending exceptions waiting for the initiation of the next instruction.
- EXCP: An FSAVE instruction that generates this size state frame indicates that the floating-point unit encountered an exception while attempting to complete the execution of the previous floating-point instructions, or that an FRESTORE of an EXCP frame occurred previously.

The FSAVE does not save the programmer's model registers of the floating-point unit; it saves only the user invisible portion of the machine. The FSAVE instruction may be used with the FMOVEM instruction to perform a full context save of the floating-point unit that includes the floating-point data registers and system control registers. To accomplish a complete context save, first execute an FSAVE instruction to suspend the current operation and save the internal state, then execute the appropriate FMOVEM instructions to store the programmer's model.



FSAVE

Save Internal Floating-Point State
(MC68060 only)

FSAVE

Floating-Point Status Register: Not affected.

Instruction Format:

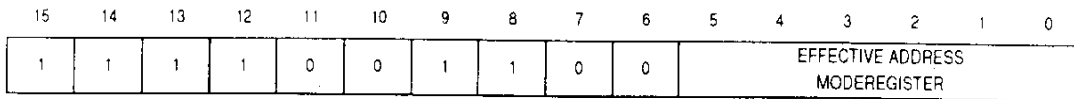

Instruction Field:

Effective Address field—Determines the addressing mode for the state frame. Only pre-decrement or control alterable addressing modes can be used as listed in the following table:

Addressing Mode	Mode	Register	Addressing Mode	Mode	Register
Dn	—	—	(xxx).W	111	000
An	—	—	(xxx).L	111	001
(An)	010	reg. number:An	#<data>	—	—
(An) +	—	—			
-(An)	100	reg. number:An	(d ₁₆ .PC)	—	—
(d ₁₆ .An)	101	reg. number:An	(d ₈ .PC,Xn)	—	—
(d ₈ .An,Xn)	110	reg. number:An	(bd,PC,Xn)	—	—
(bd,An,Xn)	110	reg. number:An	([bd,PC,Xn],od)	—	—
([bd,An,Xn],od)	110	reg. number:An	([bd,PC,Xn],od)	—	—
([bd,An],Xn,od)	110	reg. number:An	([bd,PC],Xn,od)	—	—

Freescale Semiconductor, Inc.



LPSTOP

Low-Power Stop

(MC68060, MC68LC060, MC68EC060)

LPSTOP

Operation: If Supervisor State
 Generate an LPSTOP Broadcast Cycle
 Immediate Data \downarrow SR
 "10110" \downarrow PST[4:0]
 STOP
 Else TRAP

Assembler

Syntax: LPSTOP #<data>

Attributes: Size = (Word) Privileged

Description: Moves the immediate operand into the status register (SR). The program counter (PC) is advanced to the next instruction and the processor stops fetching and executing instructions.

An interrupt or reset exception causes the processor to resume instruction execution from an LPSTOP state. If an interrupt request is asserted with a higher priority than the current priority level set by the new SR value, an interrupt exception occurs; otherwise the interrupt request is ignored. An external reset always initiates reset exception processing.

A trace exception occurs if the trace bit in the SR is enabled when the LPSTOP instruction begins execution.

A privilege violation is caused by attempting to clear the S-bit of the SR on LPSTOP.

The MC68060 executes the LPSTOP instruction as follows:

1. It synchronizes the pipelines.
2. An LPSTOP broadcast cycle is generated (write cycle):

TT1–TT0 = 3

TM2–TM0 = 0

SIZ1–SIZ0 = 2

31–A0 = \$FFFFFFFE

D15–D0 = immediate data



LPSTOP

Low-Power Stop

LPSTOP

(MC68060, MC681C060, MC68EC060)

3. At the time of the bus cycle termination, (\overline{TA} or \overline{TEA}) the state of bus grant determines how the processor will leave the system bus while in the low-power stopped state. If the processor is granted the bus, it will drive the transfer attributes, address bus, data bus, and most control signals high while in the low-power stopped state. If the bus grant is removed from the processor, it will threestate all threestateable signals of the system bus at the conclusion of the bus write broadcast cycle.
4. After the broadcast cycle is complete the processor will load the immediate operand into the SR and drive the PST lines signalling the low-power stopped state has been entered.
5. Once the low-power stopped state has been entered, the internal processor clock is disabled (except to a small number of flip flops to support interrupt and reset recognition) and all input signals except the \overline{RSTI} and \overline{IPLx} , may float. The processor clock (CLK) input may be stopped during the low-power stopped state for additional power saving. If this is done, CLK must be stopped in the low state.
6. During entry into the low-power stopped state, the system bus must be quiescent from the cycle after the broadcast cycle termination until the PST signals indicate the low-power stopped state. During exit from the low-power stopped state, the system bus must be quiescent and control signal inputs to the processor negated, beginning with the cycle \overline{RSTI} , or \overline{IPLx} is asserted until the PST signals indicate that the processor is in an exception processing state.

Condition Codes:

Set according to the immediate operand.

Instruction Format:

15	14	13	12	11	10	9	8	7	6	5	4	3	2	1	0
1	1	1	1	1	0	0	0	0	0	0	0	0	0	0	0
0	0	0	0	0	0	0	1	1	1	0	0	0	0	0	0
IMMEDIATE DATA															

Instruction Fields:

Immediate field—Specifies the data to be loaded into the status register.



MOVEC

Move Control Register

MOVEC

(MC68060, MC68LC060 and MC68EC060)

Operation: If Supervisor State
 Then Rc ← Rn or Rn ← Rc
 Else TRAP

Assembler Syntax: MOVEC Rc,Rn
 MOVEC Rn,Rc

Attributes: Size = (Long)

Description: Moves the contents of the specified control register (Rc) to the specified general register (Rn) or copies the contents of the specified general register to the specified control register. This is always a 32-bit transfer, even though the control register may be implemented with fewer bits. Unimplemented bits are read as zeros.

Condition Codes: Not affected.

Instruction Format:

15	14	13	12	11	10	9	8	7	6	5	4	3	2	1	0
0	1	0	0	1	1	1	0	0	1	1	1	1	0	1	dr
A/D	REGISTER				CONTROL REGISTER										

Instruction Fields:

- dr field—Specifies the direction of the transfer.
 - 0—Control register to general register.
 - 1—General register to control register.
- A/D field—Specifies the type of general register.
 - 0—Data Register
 - 1—Address Register



MOVEC

Move Control Register (MC68060, MC68LC060 and MC68EC060)

MOVEC

Register field—Specifies the register number.

Control Register field—Specifies the control register.

Hex ¹	Control Register
000	Source Function Code (SFC)
001	Destination Function Code (DFC)
002	Cache Control Register (CACR)
003 ²	MMU Translation Control Register (TC)
004	Instruction Transparent Translation Register 0 (ITT0)
005	Instruction Transparent Translation Register 1 (ITT1)
006	Data Transparent Translation Register 0 (DTT0)
007	Data Transparent Translation Register 1 (DTT1)
008	Bus Control Register (BUSCR)
800	User Stack Pointer (USP)
801	Vector Base Register (VBR)
806 ³	User Root Pointer (URP)
807 ³	Supervisor Root Pointer (SRP)
808	Processor Configuration Register (PCR)

NOTES:

1. Any other code causes an illegal instruction exception.
2. The E and P bits are undefined for the MC68EC060.
3. These registers are undefined for the MC68EC060.



PLPA

Load Physical Address
(MC68060, MC68LC060)

PLPA

Operation: If Supervisor State
Then Logical Address {DFC,An} translated to Physical Address \rightarrow An
Else TRAP

Assembler Syntax: PLPAR (An)
PLPAW (An)

Attributes: Unsized

Description: Translates the logical address defined by the contents of the destination function code register (DFC2–DFC0) and the address register (An31–An0), using full paged MMU functionality including TTRs, and generates a 32-bit physical address, which is loaded into An. All access error checks are performed during the translation, including in the checks the read/write instruction type, and an access error exception will be taken for faulting conditions.

PLPA is a privileged instruction; attempted execution in user mode will result in a privilege violation exception.

As with normal address translation activity:

```

If Data TTR hit
    Then Use TTR translation and An stays the same
Else if E bit of TC Register = 0 or  $\overline{\text{MDIS}}$  pin asserted
    Then Use Default TTR translation and An stays the same
Else if E bit of TC Register = 1 and  $\overline{\text{MDIS}}$  pin negated and Data ATC hit
    Then use ATC translation and An = Physical Address
Else if E bit of TC Register = 1 and  $\overline{\text{MDIS}}$  pin negated and Data ATC miss
    Then Tablewalk
    If Valid Page Descriptor Encountered
        Then update Data ATC and An = Physical Address
    Else Take Access Error Exception
EndIF

```

Condition Codes:
Not affected.



MC68060 Instructions

PLPA

Test a Logical Address
(MC68060, MC68LC060)

PLPA

Instruction Format:

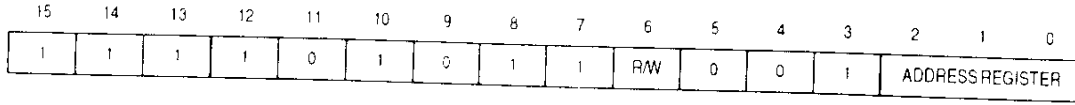

Instruction Fields:

R/W field—Specifies simulating a read or write bus transfer.

0—Write

1—Read

Register field—Specifies the address register containing the effective address for the instruction.



PLPA

Load Physical Address
(MC68EC060 Only)

PLPA

Operation: If Supervisor State
Then No Operation
Else TRAP

Assembler Syntax: PLPAR (An)
PLPAW (An)

Attributes: Unsized

Description: This instruction must not be executed on an MC68EC060.

Instruction Format:

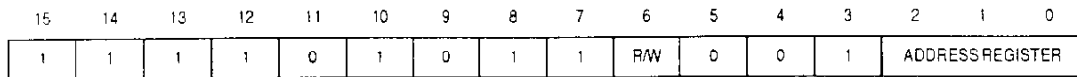

Instruction Fields:

R/W field—Specifies simulating a read or write bus transfer.
0—Write
1—Read

Register field—Specifies the address register containing the effective address for the instruction.



PFLUSH

Flush ATC Entries
(MC68EC060 Only)

PFLUSH

Operation: If Supervisor State
Then No Operation
Else TRAP

Assembler

Syntax: PFLUSH (An)
PFLUSHN (An)

Attributes: Unsized

Description: This instruction must not be executed on an MC68EC060.

Instruction Format:

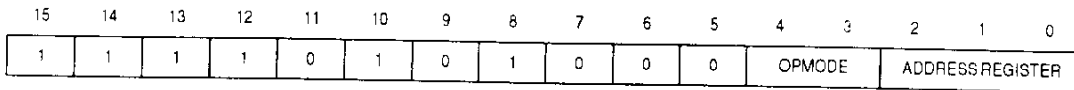

Instruction Fields:

Opmode field—Specifies the flush destination. These bits are defined for the MC68060 and MC68LC060, not for the MC68EC060.

Register field—Specifies the address register containing the effective address for the instruction entry.



INDEX

A

access error 11-3, 11-4
 recovery 8-25
 exception 8-5
 acknowledge termination ignore state
 capability 7-4, 7-74
 address bus (A31–A0) 2-3, 7-1, 7-12
 address error exception 8-7
 address registers 3-2
 address translation cache 1-9, 4-1, 4-24,
 8-6, 7-47, 10-12
 addressing modes 1-14
 AESOP electronic bulletin board C-29
 alternate bus master 2-3, 2-4, 2-8
 alternate function code registers 3-5
 $\overline{\text{AVEC}}$ signal 2-13, 7-35

B

$\overline{\text{BB}}$ signal 2-11, 7-53
 $\overline{\text{BG}}$ signal 2-10
 $\overline{\text{BGR}}$ signal 2-10
 bit manipulation instructions 10-19
 BKPT instruction 7-36
 boundary scan
 chain 9-10
 register 9-7
 $\overline{\text{BR}}$ signal 2-10
 branch cache 1-7, 5-14, 8-29
 branch instruction 10-21
 branch prediction error 8-29
 branch/set on unordered exception C-19
 breakpoint acknowledge cycle 7-36, 8-12
 breakpoint instructions 8-11
 BS3–BS0 2-7, 7-6
 BSDL Description 9-17
 $\overline{\text{BTT}}$ signal 2-10, 7-58
 burst-inhibited line transfers 7-15

bus arbitration 7-52
 $\overline{\text{BB}}$ protocol 7-53
 $\overline{\text{BTT}}$ protocol 7-58
 MC68040-arbitration protocol 7-53
 MC68060-arbitration protocol 7-58
 states 7-56
 bus clock (BCLK) 7-3
 bus control register (BUSCR) 1-13, 7-4
 bus controller 1-10
 bus error 7-46, 8-5
 bus operation speed 7-3
 bus serialization 7-52
 BYPASS instruction 9-4, 9-6
 bypass register 9-15
 byte enable signals 7-7

C

cache 8-27, 10-12
 coherency 5-1, 5-10
 copyback mode 5-7
 inhibited 5-7
 line format 5-2
 mode 4-7, 4-25, 11-5
 writethrough mode 5-7
 cache control register (CACR) 1-13, 5-5,
 11-3
 CAS/CAS2 instructions 7-29, 7-31, 11-1
 $\overline{\text{CDIS}}$ signal 2-11, 5-6
 $\overline{\text{CIOUT}}$ signal 2-7
 $\overline{\text{CLA}}$ signal 2-4, 7-32
 CLAMP instruction 9-4, 9-6
 CLK signal 2-14, 7-1
 $\overline{\text{CLKEN}}$ signal 7-1
 condition codes register (CCR) 3-3
 context switch 11-5
 copyback 11-4
 CPUSH instruction 5-13, D-11



Index

D

data bus (D31–D0) 2-4, 7-1, 7-12
 byte selection 7-7
 data cache 1-10
 data formats 1-14
 data registers 3-2
 debug command interface 9-25
 debug pipe control mode 9-24
 commands 9-27
 default cache mode 4-5
 default transparent translation 11-2, B-1
 divide-by-zero exception C-19
 double bus fault 7-51, 8-6
 dynamic bus sizing 7-5
 dynamic random access memory (DRAM)
 7-32, 11-15

E

effective address calculation 10-14
 emulator interrupt exception 9-32
 emulator mode 9-31
 entering 9-31
 exiting 9-32
 exception
 access error 8-5
 address error 8-7
 bus error 8-5
 divide-by-zero 6-32
 double bus fault 8-6
 floating-point 6-19
 format error 8-11
 inexact result 6-33
 instruction trap 8-7
 interrupt 8-12
 operand error 6-26
 overflow 6-28
 priority 8-17
 privilege violation 8-10
 reset 2-12, 8-14
 stack frame 8-3
 trace 8-10
 underflow 6-30
 unimplemented integer 8-8
 vector table 8-4
 exception processing 8-1
 execution times 10-26

flowchart 8-1

interrupt 8-13

return 8-19

execution times

bit manipulation instructions 10-19

branch instruction 10-21

exception processing 10-17, 10-22,
 10-26

floating-point instructions 10-24

MOVE instruction 10-14

multiprecision instructions 10-22

shift/rotate instructions 10-19

single-operand instruction 10-18

standard instruction 10-16

execution unit 2-13

external bus arbiter 2-6, 2-10, 7-29, 7-52,
 7-65

EXTEST instruction 9-4

F

fault address 8-22

fault status long word (FSLW) 8-22, 8-25

floating-point

data formats 6-7

data registers 6-3

disabled exception 8-9

exceptions 6-19

instructions 10-24, C-11

state frame 6-35

unimplemented instruction exception 8-8

unsupported data type exception 8-8

floating-point control register (FPCR) 6-3

floating-point instruction address register
 (FPIAR) 6-7

floating-point status register (FPSR) 6-4

floating-point unit (FPU) 1-8

programming model 6-2

format error exception 8-11

FRESTORE instruction D-13

FSAVE instruction D-16

functional signal groups 2-3

H

HALT instruction 9-30

HIGHZ instruction 9-4, 9-6

I

IDCODE instruction 9-4, 9-5
 illegal instruction exception 8-9
 immediate instruction 10-17
 imprecise exception mode 11-6
 indirect descriptor 4-12
 instruction D-1
 execution times 10-1
 illegal 8-9
 JTAG 9-3
 LPSTOP D-19
 MOVE16 2-4, 2-5
 MOVEC D-21
 RESET 2-12
 timing assumptions 10-10
 TLNx 2-5
 instruction cache 1-9
 instruction fetch
 pipeline 8-17
 unit 1-4, 1-7, 3-2
 instruction pipe unit 5-1
 instruction restart model 7-52
 instruction set 1-15
 instruction shift register 9-3
 instruction trap exception 8-7
 integer unit 1-7, 1-8, 3-1
 execution unit 2-13
 interrupt acknowledge cycle 2-13, 7-32
 autovector 7-35
 normal termination 7-35
 spurious 7-35
 interrupt exception 7-34, 8-12
 interrupt level 8-3, 8-12
 interrupt priority level 2-12
 interrupt priority mask 7-32, 8-12
 interrupts
 interrupt acknowledge transfer 2-13
 IPEND 2-12
 IPEND signal 2-12, 7-33
 IPLx signals 2-12, 7-4, 7-32, 8-12

J

JTAG 2-15
 disabling 9-15
 idcode register 9-7
 instructions 9-3

mode 9-1
 test data registers 9-7
 signal 9-15
 states 9-2

L

LEA, PEA, MOVEM instructions 10-22
 line read transfers 7-15
 line write transfer 7-25
 LOCK signal 2-6
 LOCKE signal 2-6
 locked transfers 2-6
 LPSAMPLE instruction 9-4, 9-5
 LPSTOP 9-15
 broadcast cycle 7-39
 instruction 7-38, 8-11, D-19

M

M68060 family 1-3
 M68060 software package (M68060SP)
 11-1, 11-2, C-1, D-1
 installation C-27
 MC68020 7-5, 11-3
 MC68030 7-5, 11-3
 MC68040 11-1, 11-6
 acknowledge termination protocol 7-76
 MC68040V
 LPSTOP broadcast cycles 2-4
 MC68060
 block diagram 1-5
 features 1-4
 MC68150 dynamic bus sizer 7-5
 MC68EC040 11-2
 MC68EC040V
 LPSTOP broadcast cycles 2-4
 MC68EC060 1-3, B-1
 MC68LC040 11-2
 MC68LC060 1-3, A-1
 MDIS signal 2-12, 4-1
 memory management unit (MMU) 1-9, 8-6
 features 4-1
 programming model 4-3
 status register 11-4
 misaligned operands 7-9, 7-31
 MOVE instruction
 execution times 10-14



Index

MOVEC instruction 4-30, 5-6, 7-4, 7-29,
11-2, 11-4, D-21
MOVES instruction 10-22

N

native-MC68060 acknowledge termination
protocol 7-76

O

operand error C-17
operand execution pipeline 1-4, 3-1, 8-1,
10-1
operand pipe unit 5-1
operands
 misaligned 7-9
operating system C-23
overflow 6-16

P

page descriptor 4-12
PFLUSH instruction 4-3, 4-30, B-1
PLPA instruction 4-30, 11-4, B-1
pointer table descriptors 4-12
power supply 2-16
precise exception mode 11-6
privilege violation exception 8-10
processor configuration register 1-13, 3-5,
8-8, 11-2
program counter 3-3, 8-3, 8-21
programming model 1-11
 FPU 6-2
 integer unit portion 3-2
 MMU 4-3
 supervisor 1-13
 user 1-13
PSTx signals 2-13
PTEST instruction 11-4
PULSE instruction 9-30
push buffer 5-13, 8-27

R

$\overline{R/W}$ signal 2-6
read transfer 7-12
read-modify-write transfer 7-28
register
 A6-A0 3-2

CCR 5-5
D7-D0 3-2
FP7-FP0 6-3
FPCR 6-3
FPIAR 6-7
FPSR 6-4
PCR 8-8

reset 2-12, 7-71, 11-2
reset exception 8-14
RESET instruction 7-73
retry bus operation 7-48
root table descriptors 4-12
rounding
 algorithm 6-13
 modes 6-4
 precision 6-3

\overline{RSTI} signal 2-12, 7-4, 7-71, 8-14
 \overline{RSTO} signal 2-12, 8-15
RTE instruction 8-3, 9-32

S

SAMPLE/PRELOAD instruction 9-4, 9-5
 \overline{SAS} signal 2-8
shift/rotate instructions 10-19
signals
 A31-A0 2-3
 \overline{AVEC} 2-13
 \overline{BB} 2-11
 \overline{BG} 2-10
 \overline{BGR} 2-10
 \overline{BR} 2-10
 BSx 2-7
 \overline{BTT} 2-10
 \overline{CDIS} 2-11
 \overline{CIOUT} 2-7
 \overline{CLA} 2-4
 CLK 2-14
 \overline{CLKEN} 2-15
 D31-D0 2-4
 \overline{IPEND} 2-12
 IPLx 2-12
 \overline{LOCK} 2-6
 \overline{LOCKE} 2-6
 \overline{MDIS} 2-12
 PSTx 2-13
 \overline{RSTI} 2-12
 \overline{RSTO} 2-12



$\overline{R/W}$ 2-6
 \overline{SAS} 2-8
 $SIZx$ 2-6
 \overline{SNOOP} 2-9
 \overline{TA} 2-8
 \overline{TBI} 2-9
 \overline{TCI} 2-9
 \overline{TEA} 2-9
 \overline{TIP} 2-8
 $TLNx$ 2-5
 TMx 2-4
 TRA 2-9
 \overline{TS} 2-8
 TTx 2-4
 $UPAx$ 2-5
 single-operand instruction 10-18
 $SIZx$ signals 2-6, 7-10
 $SNAN$ 6-25, C-17
 \overline{SNOOP} signal 2-9, 7-68
 snooping 1-10, 7-68
 SRP register 4-3
 stack frame
 exception 8-3
 floating-point post-instruction 8-20
 stack frame
 eight word 8-21
 four word 8-19
 six word 8-20
 status register (SR) 1-11, 3-3, 3-4, 5-15,
 7-32, 8-1, 10-22
 STOP instruction 8-11
 store buffer 8-27
 superscalar 10-1
 supervisor stack pointer 3-3, 8-3, 11-1

T

\overline{TA} signal 2-8, 8-9
 table search accesses 4-19, 8-27
 TAP controller 2-15
 \overline{TBI} signal 2-9
 \overline{TCI} signal 2-9
 \overline{TEA} signal 2-9, 8-9
 test access port 9-1
 $THERM1$, $THERM0$ pins 2-16

thermal characteristics 12-1
 thermal management 11-17
 \overline{TIP} signal 2-8
 $TLNx$ signals 2-5
 TMx signals 2-4
 \overline{TRA} signal 2-9
 trace
 exception 8-10
 mode 8-18, 11-5
 transfer
 burst-inhibited line 7-15
 line read 7-15
 line write 7-25
 read 7-12
 read-modify-write 7-28
 write 7-20
 translation control register (TCR) 1-3, 1-13,
 4-4, 11-2, 11-3
 transparent translation registers (TTRs) 1-3,
 4-2, 4-6, 4-27
 \overline{TS} signal 2-8
 TTx signals 2-4

U

underflow 6-16
 unimplemented A-line exception 8-8
 unimplemented effective address exception
 8-8
 unimplemented F-line exception 8-9
 unimplemented instruction exceptions 8-8
 unimplemented integer exception 8-8
 unimplemented integer instructions C-5
 $UPAx$ signals 2-5
 URP register 4-3
 user page attributes 4-6, 4-26
 user stack pointer 3-2

V

vector base register (VBR) 1-13, 3-4, 8-3
 virtual memory 11-3

W

write buffer 5-13, 8-27
 write transfer 7-20



Introduction	1
Signal Description	2
Integer Unit	3
Memory Management Unit	4
Caches	5
Floating-Point Unit	6
Bus Operation	7
Exception Processing	8
IEEE 1149.1 Test (JTAG) and Debug Pipe Control Modes	9
Instruction Execution Timing	10
Applications	11
Electrical and Thermal Characteristics	12
Ordering Information and Mechanical Data	13
MC68LC060	A
MC68EC060	B
MC68060 Software Package	C
M68060 Instructions	D
Index	i

- 1** Introduction
- 2** Signal Description
- 3** Integer Unit
- 4** Memory Management Unit
- 5** Caches
- 6** Floating-Point Unit
- 7** Bus Operation
- 8** Exception Processing
- 9** IEEE 1149.1 Test (JTAG) and Debug Pipe Control Modes
- 10** Instruction Execution Timing
- 11** Applications
- 12** Electrical and Thermal Characteristics
- 13** Ordering Information and Mechanical Data
- A** MC68LC060
- B** MC68EC060
- C** MC68060 Software Package
- D** M68060 Instructions
- I** Index

The world's most innovative products are powered by

**Literature Distribution Centers:**

USA: Motorola Literature Distribution; P.O. Box 20912; Phoenix, Arizona 85036.

EUROPE: Motorola Ltd.; European Literature Centre; 88 Tanners Drive, Blakelands, Milton Keynes, MK14 5BP, England.

JAPAN: Nippon Motorola Ltd.; 4-32-1, Nishi-Gotanda, Shinagawa-ku, Tokyo 141, Japan.

ASIA-PACIFIC: Motorola Semiconductors H.K. Ltd.; Silicon Harbour Center, No. 2 Dai King Street, Tai Po Industrial Estate, Tai Po, N.T., Hong Kong.



**For More Information On This Product,
Go to: www.freescale.com**