

Amplifier Built-in  
**Compact Photoelectric Sensor**  
CX-400 SERIES Ver.2

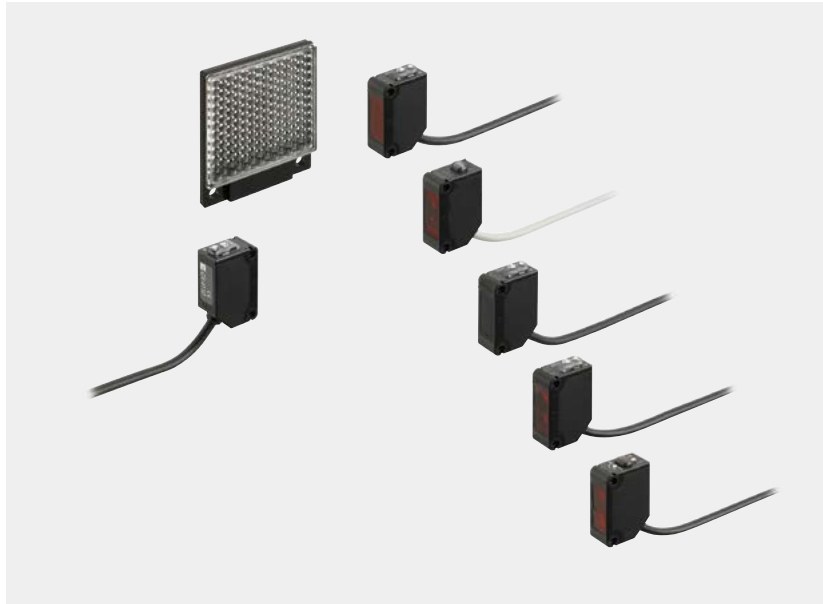

# CX-400 SERIES Ver.2

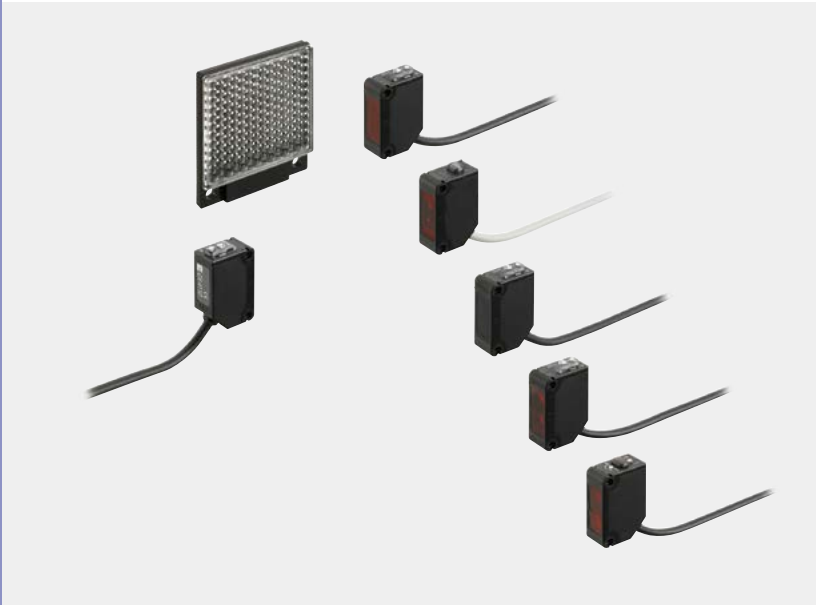

## Sensors that are environmentally and user friendly.

### Reducing environmental burdens further Up to 60% less power consumption

The various lineup covers through the inclusion of a newly developed custom integrated circuit. The CX-400 series achieves reductions in power consumption of up to 60%, averaging 44% reduction when upgrading due to its unique design. These sensors reduce carbon emissions and contribute to environmental friendliness.

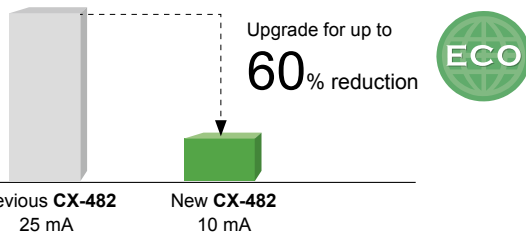

### Contributing to reduced carbon dioxide emissions

Electricity consumed by the CX-400 series has been reduced on average 10.5 mA. Calculating 8 hours/day, 260 days (operating 5 days/week) for a total of 2,080 hours/year leads to:

▶ The CX-400 contributes

**Approx. 84.6 t** annually in carbon dioxide reductions to the world

### Strong against oil and coolant liquids **CX-41□/42□/49□**

The lens material for the thru-beam type, retroreflective type (excluding the CX-48□) and the diffuse reflective type are made of a strong acrylic that resists the harmful effects of coolants. These sensors can be used with confidence even around metal processing machinery that disperses oil mists. The protection mechanism also conforms to IP67 (IEC).

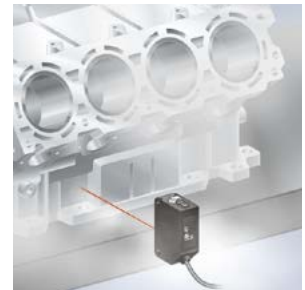

Test Oil	JIS Standard	Product Name
Lubricant	-	Velocity Oil No. 3
Water-insoluble cutting oil	2-5	Daphnecut AS-30D
	2-11	Yushiron Oil No.2ac (Note)
Water-soluble cutting oil	W1-1	Yushiron Lubic HWC68 (Note)
	W2-1	Yushiroken S50N (Note)

1,000 hours; Immersion (depth 0 m); Insulation resistance 20 MΩ/250 V  
Note: Yushiron and Yushiroken are registered trademarks of Yushiro Chemical Industry Co., Ltd.

### Strong against ethanol **CX-44□/48□**

A strong, ethanol resistant polycarbonate was used for the front and display covers. Safe even for installing near food processing machinery that disperses ethanol based detergents. The protection mechanism also conforms to IP67 (IEC).



Caution: Set the CX-48□ so that cleaning liquid will not get on to the attached reflector.

**APPLICATIONS**

**Detecting out of position tape feeder cassette**

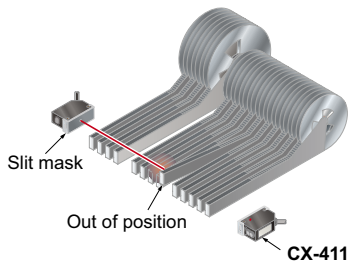

**Detecting objects in dusty environment**

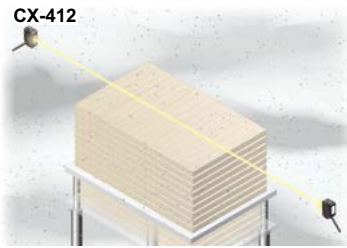

**Passage confirmation of object on a conveyor belt**

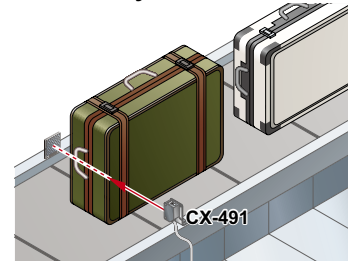

**Detecting transparent glass bottles**

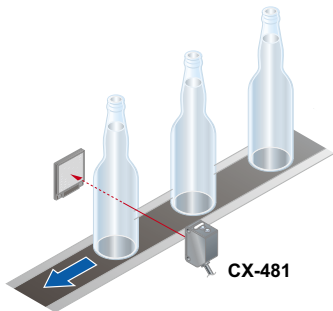

**Detecting a small tablet**



**Detecting a biscuit**

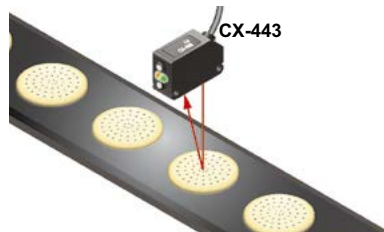

**BASIC PERFORMANCE**

**Strong infrared beam**

**CX-412/413**

Remarkable penetrating power enables applications such as package content detection.

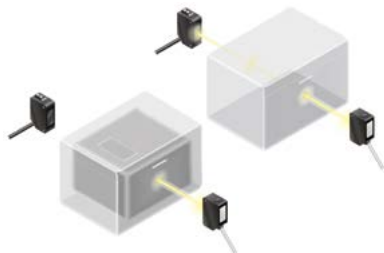

Note: When sensing utilizing penetrating power, make sure to verify using the actual sensor.

**Can sense differences as small as 0.4 mm 0.016 in, with hysteresis of 2 % or less**

**CX-441/443**

An advanced optical system provides sensing performance that is 2.5 times approx. than conventional models. Even ultra-small differences of 0.4 mm 0.016 in can be detected accurately.

2.5 times the sensing capability!

Height differences of as little as 0.4 mm 0.016 in can be detected at a setting distance of 20 mm 0.787 in



**Hardly affected by colors**

**CX-441/443**

Both black and white objects can be sensed at the same distances. No adjuster control is needed, even when products of different colors are moving along the production line.

30 % higher sensing capability



**Retroreflective type with polarizing filters**

**CX-491**

Built-in polarizing filters ensure stable sensing even on a specular object.

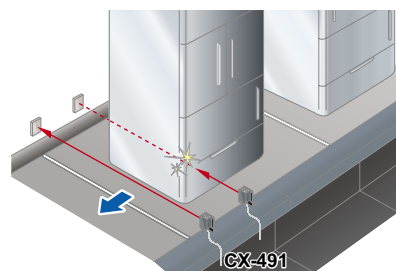

[The difference in sensing ranges is 1% or less between non-glossy white paper with a setting distance of 50 mm 1.969 in and non-glossy gray paper with a brightness level of 5.]

**BASIC PERFORMANCE****Introducing the transparent object sensing type sensor****CX-48□**

Our unique optical system and transparent object sensing circuitry provide stable sensing of even thinner transparent objects than the conventional models.

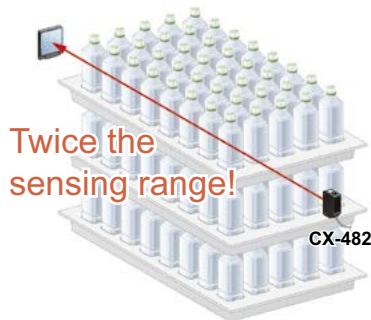

Transparent objects detectable with **CX-48□** (Typical examples)

Sensing object	Sensing object size (mm in)
Glass sheet	50 × 50 1.969 × 1.969 t = 0.7 0.028
Cylindrical glass	ø50 ø1.969 ℓ = 50 1.969 t = 1.3 0.051
Acrylic board	50 × 50 1.969 × 1.969 t = 1.0 0.039
Styrol (Floppy case)	50 × 50 1.969 × 1.969 t = 0.9 0.035
Food wrapping film	50 × 50 1.969 × 1.969 t = 10 μm 0.394 mil
Cigarette case film	50 × 50 1.969 × 1.969 t = 20 μm 0.787 mil
Vinyl sack	50 × 50 1.969 × 1.969 t = 30 μm 1.181 mil
PET bottle (500mℓ)	ø66 ø2.598

Reflector setting range **CX-481**: 300 to 500 mm 11.811 to 19.685 in,  
**CX-482**: 1 to 2 m 3.281 to 6.562 ft

[with the **RF-230** reflector at the optimum condition (Note)]

Each object should pass across the beam at the center between the sensor and the reflector.

ℓ: Length of cylindrical glasses

t: Thickness of sensing object

Note: The optimum condition is defined as the condition in which the sensitivity level is set such that the stability indicator just lights up when the object is absent.

**Long sensing range of 5 m 16.4 ft** **CX-493**

A long 5 m 16.4 ft sensing range is possible with the red LED type that is easy to align with the beam axis. Can be used for wide automatic door shutters.

**Ultra-long sensing range of 30 m 98.4 ft** **CX-413**

The **CX-413** achieves the ultra-long sensing range of 30 m 98.4 ft. It can be used for a stacker crane or a multilevel parking structure.

**ENVIRONMENTAL RESISTANCE****Strong on dust and dirt****CX-412/413**

Because the light source is an infrared light, it is strong on dust and dirt compared to the red beam type.

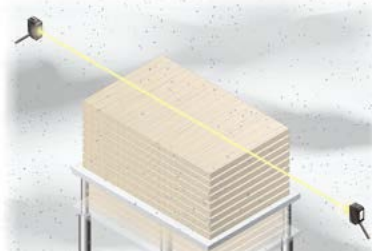
**Strong even in cold environments**

Stable performance can be maintained even in environments of -25 °C -13 °F.

**Stronger noise resistance**

The **CX-400** series has a higher noise resistance than its previous model. By incorporating an inverter countermeasure circuit that appropriately shifts with peak wavelength, the sensor now resists high-frequency noise from high-voltage inverter motors and inverter lights more effectively.

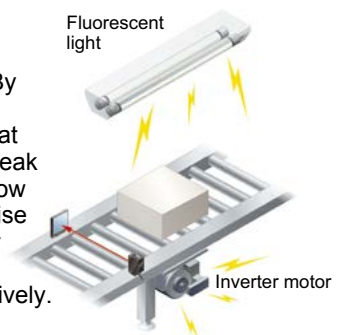
**ECO****Thoroughly eliminating unnecessary waste, Reducing many environmental burdens****ECO**

The **CX-400** series has three different cable length types and uses very simple packaging to reduce waste. The bag is made of polyethylene and does not emit toxic gasses.



## MOUNTING

### Beam axis alignment made easy with a high luminance spot beam **CX-423**

These sensors have a high luminance red LED spot beam which provides bright visibility enabling the sensing position to be checked at a glance. Because it achieved small beam spot approx.  $\varnothing 2$  mm  $\varnothing 0.079$  in at setting distance 100 mm  $3.937$  in, approx.  $\varnothing 5$  mm  $\varnothing 0.197$  in at setting distance 200 mm  $7.874$  in, even the minutest object can be accurately detected.

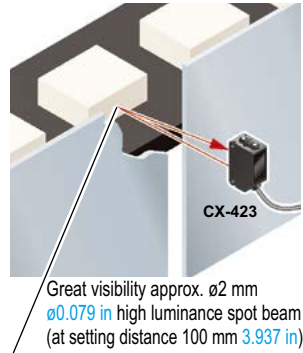

### The bright spot makes beam axis alignment easy **CX-441**

These sensors have a high luminance red spot that provides bright visibility. The sensing position can be checked at a glance. Because the **CX-441** sensor has the smallest spot in its class  $\varnothing 2$  mm  $\varnothing 0.079$  in approx., even the minutest object can be accurately detected.



## OPERABILITY

### Reduction of volume adjustment labor **CX-423**

Because these sensors possess many variations depending on the sensing range, enables you to make optimal volume adjustment easily.

**CX-422:** 800 mm  $31.496$  in  
**CX-421:** 300 mm  $11.811$  in  
**CX-424:** 100 mm  $3.937$  in



### Can be used for sensing minute differences **CX-441**

Equipped with a 5-turn adjuster so that even challenging range settings can be handled with ease.

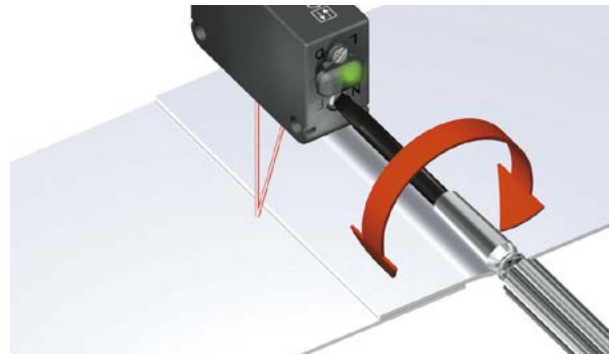

## VARIETIES

### Basic type available

Omit the sensitivity adjuster and operation mode switch and release a basic type cable  $0.5$  m  $1.641$  ft in length. If the usage is clear, quick construction can be performed onsite without detailed adjustments and the cost can be controlled.

### Less processing time



M8 plug-in connector type and M12 pigtailed type are available. This contributes to less time spent in setting up. In addition, cable types are available with cable lengths of  $0.5$  m  $1.640$  ft,  $2$  m  $6.562$  ft and  $5$  m  $16.404$  ft. This results in less wastage.

#### No unnecessary cables or terminal blocks

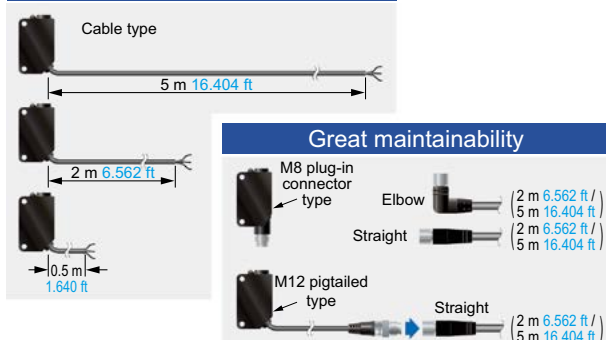

### Select from 2 spot diameters as per the application **CX-441/443**

Within the choice of  $50$  mm  $1.969$  in sensing range sensors, we offer small spot approx.  $\varnothing 2$  mm  $\varnothing 0.079$  in type optimal for detecting minute object and large approx.  $\varnothing 6.5$  mm  $\varnothing 0.256$  in spot type capable of sensing object covered with holes and grooves.

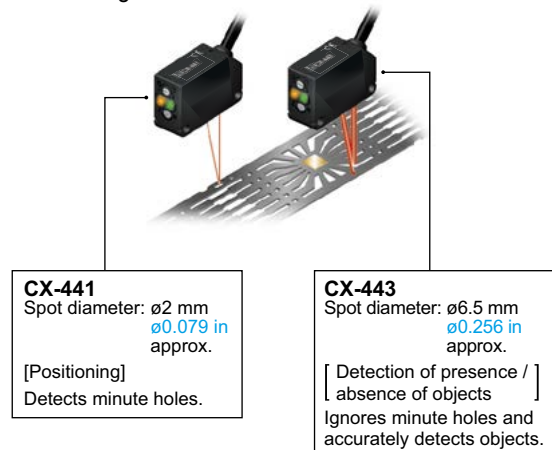

**FUNCTIONS**

**BGS/FGS functions make even the most challenging settings possible!**

**CX-44□**

**The BGS function is best suited for the following case**

**Background not present**

When object and background are separated

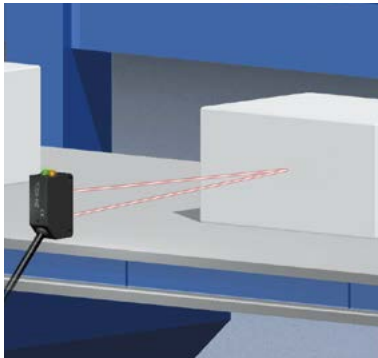

Not affected if the background color changes or someone passes behind the conveyor.

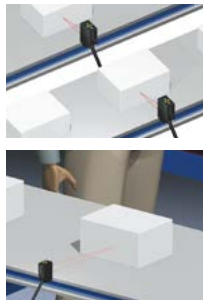

**The FGS function is best suited for the following case**

**Background present**

When object and background are close together  
When the object is glossy or uneven



Unaffected by gloss, color or uneven surfaces when sensing objects present on a conveyor belt.

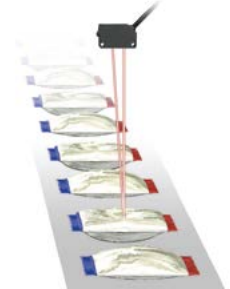

Caution: Please use the FGS function together with a conveyor or other background unit.

**BGS (Background suppression) function**

The sensor judges that an object is present when light is received at position A of the light-receiving element (2-segment element).

This is useful if the object and background are far apart. The distance adjustment method is the same as the conventional adjustment method for adjustable range reflective type sensors.

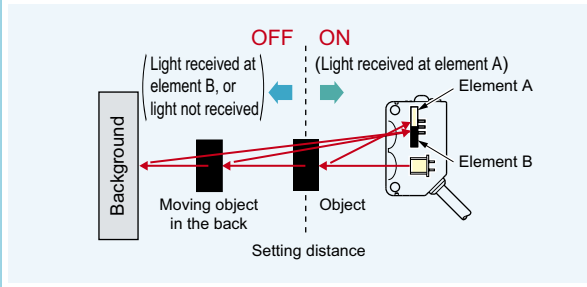

**FGS (Foreground suppression) function**

The sensor judges that an object is present when no light is received at position B of the light-receiving element (2-segment element). Accordingly, even objects that are glossy can be sensed. This is useful if the object and background are close together, or if the object being sensed is glossy.

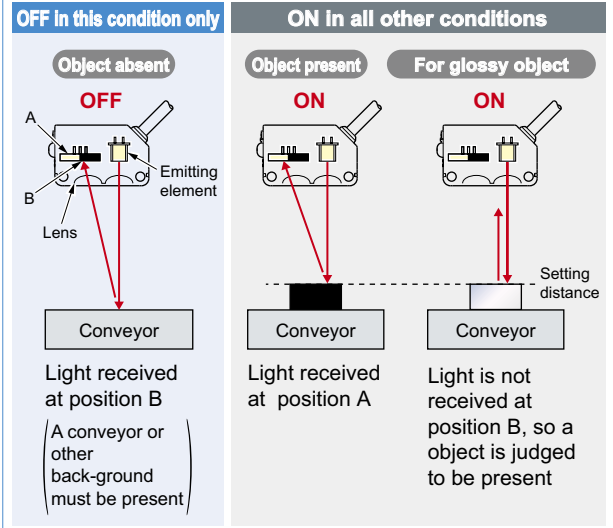

**Strong against interference**

The interference prevention function lets two sensors to be mounted close together precisely.

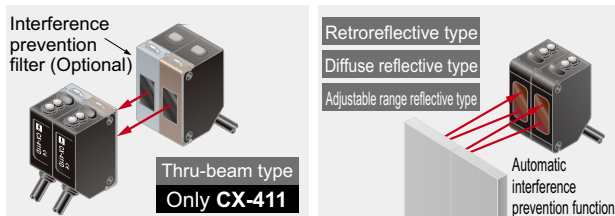

**ORDER GUIDE****Standard type**

Type	Appearance	Sensing range	Model No. (Note 1)		Output operation	Emitting element
			NPN output	PNP output		
Thru-beam Long sensing range		10 m <b>32.808 ft</b>	<b>CX-411</b>	<b>CX-411-P</b>	Switchable either Light-ON or Dark-ON	Red LED
		15 m <b>49.213 ft</b>	<b>CX-412</b>	<b>CX-412-P</b>		Infrared LED
		30 m <b>98.425 ft</b>	<b>CX-413</b>	<b>CX-413-P</b>		Infrared LED
Retroreflective For transparent object sensing		3 m <b>9.843 ft</b> (Note 2)	<b>CX-491</b>	<b>CX-491-P</b>		Red LED
		5 m <b>16.404 ft</b> (Note 2)	<b>CX-493</b>	<b>CX-493-P</b>		Red LED
		50 to 500 mm <b>1.969 to 19.685 in</b> (Note 2)	<b>CX-481</b>	<b>CX-481-P</b>		Infrared LED
		50 to 1,000mm <b>1.969 to 39.37 in</b> (Note 2)	<b>CX-483</b>	<b>CX-483-P</b>	Infrared LED	
Diffuse reflective Narrow-view		100 mm <b>3.937 in</b>	<b>CX-424</b>	<b>CX-424-P</b>	Infrared LED	
		300 mm <b>11.811 in</b>	<b>CX-421</b>	<b>CX-421-P</b>		
		800 mm <b>31.496 in</b>	<b>CX-422</b>	<b>CX-422-P</b>		
		70 to 300 mm <b>2.756 to 11.811 in</b>	<b>CX-423</b>	<b>CX-423-P</b>	Red LED	
		Adjustable range reflective Small spot		2 to 50 mm <b>0.079 to 1.969 in</b>	<b>CX-441</b>	<b>CX-441-P</b>
15 to 100 mm <b>0.591 to 3.937 in</b>	<b>CX-443</b>			<b>CX-443-P</b>		
20 to 300 mm <b>0.787 to 11.811 in</b>	<b>CX-442</b>			<b>CX-442-P</b>		

**NOTE: Mounting bracket is not supplied with the sensor. Please select from the range of optional sensor mounting brackets.**

Notes: 1) The model No. with "E" shown on the label affixed to the thru-beam type sensor is the emitter, "D" shown on the label is the receiver.



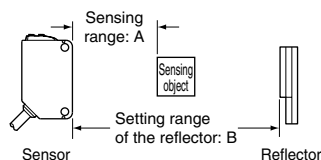



2) The sensing range of the retroreflective type sensor is specified for the **RF-230** (optional) reflector. The sensing range represents the actual sensing range of the sensor. The sensing ranges itemized in "A" of the table below may vary depending on the shape of sensing object. Be sure to check the operation with the actual sensing object.



	<b>CX-491</b> □	<b>CX-493</b> □	<b>CX-481</b> □	<b>CX-483</b> □	<b>CX-482</b> □
A	0 to 3 m <b>0 to 9.843 ft</b>	0 to 5 m <b>0 to 16.404 ft</b>	50 to 500 mm <b>1.969 to 19.685 in</b>	50 to 1,000 mm <b>1.969 to 39.37 in</b>	0.1 to 2 m <b>0.328 to 6.562 ft</b>
B	0.1 to 3 m <b>0.328 to 9.843 ft</b>	0.1 to 5 m <b>0.328 to 16.404 ft</b>	100 to 500 mm <b>3.937 to 19.685 in</b>	100 to 1,000 mm <b>3.937 to 39.37 in</b>	0.8 to 2 m <b>2.625 to 6.562 ft</b>

## ORDER GUIDE

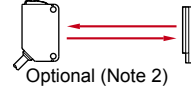
**Basic type** (Without operation mode switch and sensitivity adjuster. Cable is 0.5 m 1.640 ft long.)

Type	Appearance	Sensing range	Model No. (Note 1)		Output operation	Emitting element
			NPN output	PNP output		
Thru-beam Long sensing range		 10 m 32.808 ft	CX-411A-C05	CX-411A-P-C05	Light-ON	Red LED
			CX-411B-C05	CX-411B-P-C05	Dark-ON	
		 15 m 49.213 ft	CX-412A-C05	CX-412A-P-C05	Light-ON	Infrared LED
			CX-412B-C05	CX-412B-P-C05	Dark-ON	
Retroreflective With polarizing filters	 Optional (Note 2)	 3 m 9.843 ft (Note 3)	CX-491A-C05-Y	CX-491A-P-C05-Y	Light-ON	Red LED
			CX-491B-C05-Y	CX-491B-P-C05-Y	Dark-ON	

**NOTE:** Mounting bracket is not supplied with the sensor. Please select from the range of optional sensor mounting brackets.

Notes: 1) The model No. with "E" shown on the label affixed to the thru-beam type sensor is the emitter, "D" shown on the label is the receiver.

2) The reflector is an option. The sensing range of the reflector is specified for the **RF-230**.

3) The sensing range of the retroreflective type sensor is specified for the **RF-230** (optional) reflector (p.10). The sensing range represents the actual sensing range of the sensor. The sensing range : A of the table below may vary depending on the shape of sensing object. Be sure to check the operation with the actual sensing object.

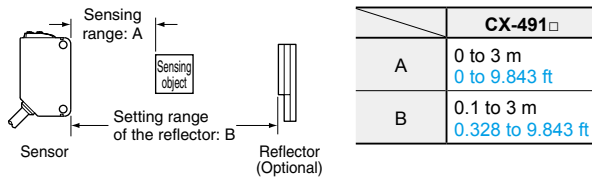



## ORDER GUIDE

### 0.5 m 1.640 ft / 5 m 16.404 ft cable length types

0.5 m 1.640 ft / 5 m 16.404 ft cable length types (standard: 2 m 6.562 ft, basic: 0.5 m 1.640 ft) are also available.

When ordering this type, suffix “-C05” for the 0.5 m 1.640 ft cable length type, “-C5” for the 5 m 16.404 ft cable length type to the model No. (Excluding CX-44□ and basic type)

(e.g.) 0.5 m 1.640 ft cable length type of CX-411-P is “CX-411-P-C05”

5 m 16.404 ft cable length type of CX-411-P is “CX-411-P-C5”

### M8 plug-in connector type, M12 pigtailed type

M8 plug-in connector type and M12 pigtailed type are also available.

When ordering this type, suffix “-Z” for the M8 connector type, “-J” for the M12 pigtailed type to the model No.

(Please note that M12 pigtailed type is not available for CX-44□. Excluding basic type)

(e.g.) M8 connector type of CX-411-P is “CX-411-P-Z”

M12 pigtailed type of CX-411-P is “CX-411-P-J”

- Mating cable (2 cables are required for the thru-beam type.)

Type		Model No.	Cable length	Description
For M8 plug-in connector type	Straight	CN-24A-C2	2 m 6.562 ft	Can be used with all models
		CN-24A-C5	5 m 16.404 ft	
	Elbow	CN-24AL-C2	2 m 6.562 ft	
		CN-24AL-C5	5 m 16.404 ft	
For M12 pigtailed type	2-core	CN-22-C2	2 m 6.562 ft	For thru-beam type emitter (2-core)
		CN-22-C5	5 m 16.404 ft	
	4-core	CN-24-C2	2 m 6.562 ft	Can be used with all models
		CN-24-C5	5 m 16.404 ft	

### Package without reflector

NPN output type: CX-491-Y

PNP output type: CX-491-P-Y

### Accessory

- RF-230 (Reflector)



### Mating cable

- CN-24A-C2  
CN-24A-C5

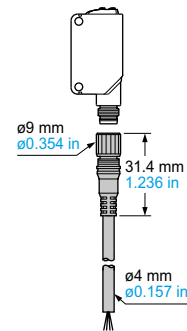

- CN-24AL-C2  
CN-24AL-C5

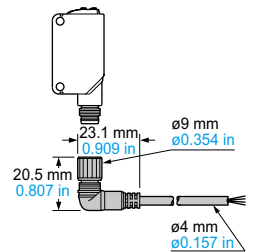

- CN-22-C2, CN-22-C5  
CN-24-C2, CN-24-C5

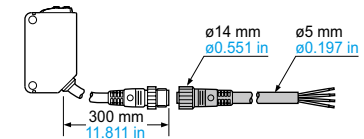

**OPTIONS**

Designation	Model No.		Slit size	Sensing range		Min. sensing object	
	Slit mask	Sensor		Slit on one side	Slit on both sides	Slit on one side	Slit on both sides
Round slit mask (For thru-beam type sensor only)	OS-CX-05	CX-411□	ø0.5 mm ø0.020 in	400 mm 15.748 in	20 mm 0.787 in	ø12 mm ø0.472 in	ø0.5 mm ø0.020 in
		CX-412□		600 mm 23.622 in	30 mm 1.181 in		
		CX-413□		1,200 mm 47.242 in	60 mm 2.362 in		
	OS-CX-1	CX-411□	ø1 mm ø0.039 in	900 mm 35.433 in	100 mm 3.937 in	ø12 mm ø0.472 in	ø1 mm ø0.039 in
		CX-412□		1.35 m 4.429 ft	150 mm 5.906 in		
		CX-413□		2.7 m 8.857 ft	300 mm 11.811 in		
	OS-CX-2	CX-411□	ø2 mm ø0.079 in	2 m 6.562 ft	400 mm 15.748 in	ø12 mm ø0.472 in	ø2 mm ø0.079 in
		CX-412□		3 m 9.843 ft	600 mm 23.622 in		
		CX-413□		6 m 19.685 ft	1,200 mm 47.242 in		
Rectangular slit mask (For thru-beam type sensor only)	OS-CX-05×6	CX-411□	0.5 × 6 mm 0.020 × 0.236 in	2 m 6.562 ft	400 mm 15.748 in	ø12 mm ø0.472 in	0.5 × 6 mm 0.020 × 0.236 in
		CX-412□		3 m 9.843 ft	600 mm 23.622 in		
		CX-413□		6 m 19.685 ft	1,200 mm 47.242 in		
	OS-CX-1×6	CX-411□	1 × 6 mm 0.039 × 0.236 in	3 m 9.843 ft	1 m 3.281 ft	ø12 mm ø0.472 in	1 × 6 mm 0.039 × 0.236 in
		CX-412□		4.5 m 14.764 ft	1.5 m 4.921 ft		
		CX-413□		9 m 29.528 ft	3 m 9.843 ft		
	OS-CX-2×6	CX-411□	2 × 6 mm 0.079 × 0.236 in	5 m 16.404 ft	2 m 6.562 ft	ø12 mm ø0.472 in	2 × 6 mm 0.079 × 0.236 in
		CX-412□		7.5 m 24.606 ft	3 m 9.843 ft		
		CX-413□		15 m 49.213 ft	6 m 19.685 ft		

Designation	Model No.	Sensing range	Min. sensing object
Interference prevention filter (For CX-411□ only)	PF-CX4-V (Vertical, Silver) 2 pcs. per set	5 m 16.404 ft (Note 1)	ø12 mm ø0.472 in (Note 1)
	PF-CX4-H (Horizontal, Light brown) 2 pcs. per set		
Reflector (For retro-reflective type sensor only)	RF-210	CX-491□	1 m 3.281 ft (Note 2)
		CX-493□	1.5 m 4.921 ft (Note 2)
		CX-481□	—
		CX-483□	0.1 to 0.3 m 0.328 to 0.984 ft (Note 2)
	RF-220	CX-482□	0.1 to 0.6 m 0.328 to 1.969 ft (Note 2)
		CX-491□	1.5 m 4.921 ft (Note 2)
		CX-493□	3 m 9.843 ft (Note 2)
		CX-481□	50 to 300 mm 1.969 to 11.811 in (Note 2)
	RF-230 (Note 3)	CX-483□	0.1 to 0.7 m 0.328 to 2.297 ft (Note 2)
		CX-482□	0.1 to 1.3 m 0.328 to 4.265 ft (Note 2)
	CX-491□-Y□	3 m 9.843 ft (Note 2)	ø50 mm ø1.969 in

Notes: 1) Value when attached on both sides.  
 2) Set the distance between the CX-491□/493□ and the reflector to 0.1 m 0.328 ft or more. However, see the table below for CX-48□.  
 The sensing range "A" may vary depending on the shape of sensing object. Be sure to check the operation with the actual sensing object.

**Round slit mask**

- OS-CX-□  
Fitted on the front face of the sensor with one-touch.

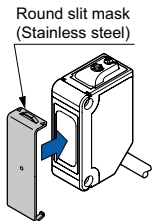

**Rectangular slit mask**

- OS-CX-□×6  
Fitted on the front face of the sensor with one-touch.

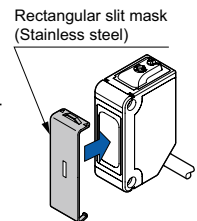

**Interference prevention filter**

- PF-CX4-V (Vertical, Silver)
- PF-CX4-H (Horizontal, Light brown)  
Two sets of CX-411□ can be mounted close together.

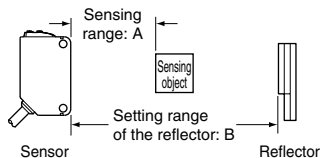
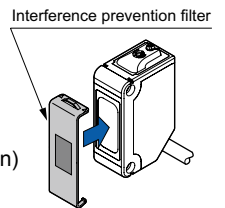

Model No.	Sensor		A	B
	Sensor	Reflector		
CX-481□	RF-220	RF-220	50 to 300 mm 1.969 to 11.811 in	100 to 300 mm 3.937 to 11.811 in
		RF-220	0.1 to 0.7 m 0.328 to 2.297 ft	0.2 to 0.7 m 0.656 to 2.297 ft
CX-483□	RF-210	RF-210	0.1 to 0.3 m 0.328 to 0.984 ft	0.1 to 0.3 m 0.328 to 0.984 ft
		RF-230	0.05 to 1 m 0.164 to 3.281 ft	0.1 to 1 m 0.328 to 3.281 ft
CX-482□	RF-220	RF-220	0.1 to 1.3 m 0.328 to 4.265 ft	0.5 to 1.3 m 1.640 to 4.265 ft
		RF-210	0.1 to 0.6 m 0.328 to 1.969 ft	0.3 to 0.6 m 0.984 to 1.969 ft

3) RF-230 is attached to the retroreflective type sensor other than the basic type.

**Reflector**

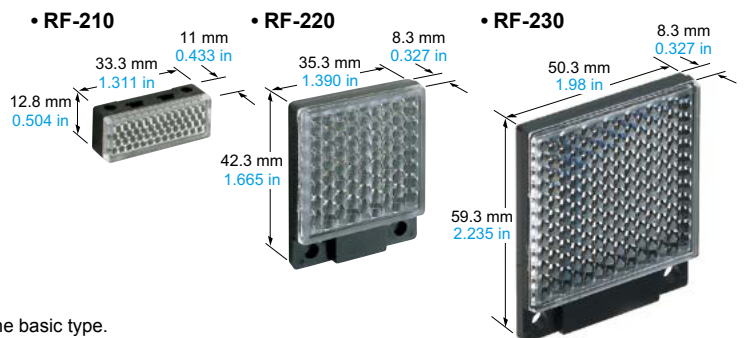

**OPTIONS**

Designation	Model No.	Description
Reflector mounting bracket	<b>MS-RF21-1</b>	Protective mounting bracket for <b>RF-210</b> It protects the reflector from damage and maintains alignment.
	<b>MS-RF22</b>	For <b>RF-220</b>
	<b>MS-RF23</b>	For <b>RF-230</b>
Reflective tape	<b>RF-11</b>	<ul style="list-style-type: none"> <li>• Sensing range (Note 2): 0.5 m <b>1.640 ft</b> [CX-491] 0.8 m <b>2.625 ft</b> [CX-493]</li> <li>• Ambient temperature: -25 to +50 °C -13 to +122 °F</li> <li>• Ambient humidity: 35 to 85 % RH</li> </ul> Notes: 1) Keep the tape free from stress. If it is pressed too much, its capability may deteriorate. 2) Do not cut the tape. It will deteriorate the sensing performance.
	<b>RF-12</b>	<ul style="list-style-type: none"> <li>• Sensing range (Note 2): 0.7 m <b>2.297 ft</b> [CX-491] 1.2 m <b>3.937 ft</b> [CX-493] 0.1 to 0.6 m <b>0.328 to 1.969 ft</b> [CX-482]</li> </ul>
	<b>RF-13</b>	<ul style="list-style-type: none"> <li>• Sensing range (Note 3): 0.5 m <b>1.640 ft</b> [CX-491]</li> <li>• Ambient temperature: -25 to +55 °C -13 to +131 °F</li> <li>• Ambient humidity: 35 to 85 % RH</li> </ul>
Sensor mounting bracket (Note 1)	<b>MS-CX2-1</b>	Foot angled mounting bracket It can also be used for mounting <b>RF-210</b> .
	<b>MS-CX2-2</b>	Foot biangled mounting bracket It can also be used for mounting <b>RF-210</b> .
	<b>MS-CX2-4</b>	Protective mounting bracket
	<b>MS-CX2-5</b>	Back biangled mounting bracket
	<b>MS-CX-3</b>	Back angled mounting bracket
Universal sensor mounting stand	<b>MS-AJ1</b>	Horizontal mounting type
	<b>MS-AJ2</b>	Vertical mounting type
	<b>MS-AJ1-A</b>	Horizontal mounting type
	<b>MS-AJ2-A</b>	Vertical mounting type
	<b>MS-AJ1-M</b>	Horizontal mounting type
Sensor checker	<b>CHX-SC2</b>	It is useful for beam alignment of thru-beam type sensors. The optimum receiver position is given by indicators, as well as an audio signal.

Notes: 1) The plug-in connector type sensor does not allow use of some sensor mounting brackets because of the protrusion of the connector.  
 2) Set the distance between the sensor and the reflective tape to 0.1 m **0.328 ft** (CX-482) 0.4 m **1.312 ft** or more.  
 3) Set the distance between the sensor and the reflective tape to 0.2 m **0.656 ft** or more.

**Universal sensor mounting stand**

**• MS-AJ1**

Swivel: 360° rotation  
Height adjustment: 150 mm **5.906 in** approx.  
Elevation angle: ±45°  
Mounting hole for M6 screw

**• MS-AJ1-A**

With the lateral arm, the sensor can sense from above a production line.  
Forward / back adjustment: 130 mm **5.118 in** approx.  
Swivel: 360° rotation  
Height adjustment: 150 mm **5.906 in** approx.  
Elevation angle: ±45°  
Mounting hole for M6 screw

**• MS-AJ1-M**

Swivel: 360° rotation  
Height adjustment: 150 mm **5.906 in** approx.  
Elevation angle: ±45°  
Mounting hole for M6 screw

**• MS-AJ2**

Swivel: 360° rotation  
Height adjustment: 150 mm **5.906 in** approx.  
Elevation angle: ±45°  
Mounting hole for M6 screw

**• MS-AJ2-A**

With the lateral arm, the sensor can sense from above a production line.  
Forward / back adjustment: 130 mm **5.118 in** approx.  
Swivel: 360° rotation  
Height adjustment: 150 mm **5.906 in** approx.  
Elevation angle: ±45°  
Mounting hole for M6 screw

**• MS-AJ2-M**

Swivel: 360° rotation  
Height adjustment: 150 mm **5.906 in** approx.  
Elevation angle: ±45°  
Mounting hole for M6 screw

**Reflector mounting bracket**

**• MS-RF21-1**

Two M3 (length 12 mm **0.472 in**) screws with washers are attached.

**• MS-RF22**

Two M3 (length 8 mm **0.315 in**) screws with washers are attached.

**• MS-RF23**

Two M4 (length 10 mm **0.394 in**) screws with washers are attached.

**Reflective tape**

**• RF-11**

30 mm **1.181 in**  
8 mm **0.315 in**  
0.7 mm **0.028 in**

**• RF-12**

30 mm **1.181 in**  
25 mm **0.984 in**  
0.7 mm **0.028 in**

**• RF-13**

30 mm **1.181 in**  
30 mm **1.181 in**  
0.5 mm **0.020 in**

**Sensor mounting bracket**

**• MS-CX2-1**

Two M3 (length 12 mm **0.472 in**) screws with washers are attached.

**• MS-CX2-2**

Two M3 (length 12 mm **0.472 in**) screws with washers are attached.

**• MS-CX2-4**

Two M3 (length 14 mm **0.551 in**) screws with washers are attached.

**• MS-CX2-5**

Two M3 (length 12 mm **0.472 in**) screws with washers are attached.

**• MS-CX-3**

Two M3 (length 12 mm **0.472 in**) screws with washers are attached.

**Sensor checker**

**• CHX-SC2**

Sensor checker

**SPECIFICATIONS**

**Standard type**

Item	Model No.	Type	Thru-beam			Retroreflective					Diffuse reflective			
			Long sensing range			With polarizing filters	Long sensing range		For transparent object sensing					
			CX-411	CX-412	CX-413	CX-491	CX-493	CX-481	CX-483	CX-482	CX-424	CX-421	CX-422	CX-423
			CX-411-P	CX-412-P	CX-413-P	CX-491-P	CX-493-P	CX-481-P	CX-483-P	CX-482-P	CX-424-P	CX-421-P	CX-422-P	CX-423-P
CE marking directive compliance														
EMC Directive, RoHS Directive														
Sensing range			10 m 32.808 ft	15 m 49.213 ft	30 m 98.425 ft	3 m 9.843 ft (Note 2)	5 m 16.404 ft (Note 2)	50 to 500 mm 1.969 to 19.685 in (Note 2)	50 to 1,000 mm 1.969 to 39.37 in (Note 2)	0.1 to 2 m 0.328 to 6.562 ft (Note 2)	100 mm 3.937 in (Note 3)	300 mm 11.811 in (Note 3)	800 mm 31.496 in (Note 3)	70 to 300 mm 2.756 to 11.811 in (Note 3)
Sensing object			ø12 mm ø0.472 in or more opaque object (Note 4)			ø50 mm ø1.969 in or more opaque, translucent or specular object (Note 2, 5)	ø50 mm ø1.969 in or more opaque or translucent object (Note 2, 5)	ø50 mm ø1.969 in or more transparent, translucent or opaque object (Note 2, 5)			Opaque, translucent or transparent object (Note 5)			Opaque, translucent or transparent object (Note 5) (Min. sensing object: ø0.5 mm ø0.020 in copper wire)
Hysteresis			—————									15 % or less of operation distance (Note 3)		
Repeatability (perpendicular to sensing axis)			0.5 mm 0.020 in or less									1 mm 0.039 in or less		0.5 mm 0.020 in or less
Supply voltage			12 to 24 V DC ±10 % Ripple P-P 10 % or less											
Current consumption			Emitter: 15 mA or less Receiver: 10 mA or less	Emitter: 20 mA or less Receiver: 10 mA or less	Emitter: 25 mA or less Receiver: 10 mA or less	13 mA or less	10 mA or less			13 mA or less			15 mA or less	
Output			<NPN output type> NPN open-collector transistor • Maximum sink current: 100 mA • Applied voltage: 30 V DC or less (between output and 0 V) • Residual voltage: 2 V or less (at 100 mA sink current) 1 V or less (at 16 mA sink current)						<PNP output type> PNP open-collector transistor • Maximum source current: 100 mA • Applied voltage: 30 V DC or less (between output and +V) • Residual voltage: 2 V or less (at 100 mA source current) 1 V or less (at 16 mA source current)					
Output operation			Switchable either Light-ON or Dark-ON											
Short-circuit protection			Incorporated											
Response time			1 ms or less	2 ms or less	1 ms or less									
Operation indicator			Orange LED (lights up when the output is ON)(incorporated on the receiver for thru-beam type)											
Stability indicator			Green LED (lights up under stable light received condition or stable dark condition)(incorporated on the receiver for thru-beam type)											
Power indicator			Green LED (lights up when the power is ON) (incorporated on the emitter)			—————								
Sensitivity adjuster			Continuously variable adjuster (incorporated on the receiver for thru-beam type)											
Automatic interference prevention function			Two units of sensors can be mounted close together with interference prevention filters. (Sensing range: 5 m 16.404 ft)			Incorporated (Two units of sensors can be mounted close together.)								
Protection			IP67 (IEC)											
Ambient temperature			-25 to +55 °C -13 to +131 °F (No dew condensation or icing allowed), Storage: -30 to +70 °C -22 to +158 °F											
Ambient humidity			35 to 85 % RH, Storage: 35 to 85 % RH											
Ambient illuminance			Incandescent light: 3,000 lx or less at the light-receiving face											
Voltage withstandability			1,000 V AC for one min. between all supply terminals connected together and enclosure											
Insulation resistance			20 MΩ, or more, with 250 V DC megger between all supply terminals connected together and enclosure											
Vibration resistance			10 to 500 Hz frequency, 1.5 mm 0.059 in double amplitude (10 G max.) in X, Y and Z directions for two hours each											
Shock resistance			500 m/s <sup>2</sup> acceleration (50 G approx.) in X, Y and Z directions three times each											
Emitting element (modulated)			Red LED	Infrared LED		Red LED	Infrared LED		Infrared LED		Infrared LED		Red LED	
Peak emission wavelength			680 nm 0.027 mil	870 nm 0.034 mil	850 nm 0.033 mil	680 nm 0.027 mil	650 nm 0.026 mil	870 nm 0.034 mil		860 nm 0.033 mil		645 nm 0.025 mil		
Material			Enclosure: PBT (Polybutylene terephthalate), Lens: Acrylic (CX-48□: Polycarbonate), Indicator cover: Acrylic (CX-48□: Polycarbonate)											
Cable			0.2 mm <sup>2</sup> 3-core (thru-beam type emitter: 2-core) cabtyre cable, 2 m 6.562 ft long											
Cable extension			Extension up to total 100 m 328.084 ft is possible with 0.3 mm <sup>2</sup> , or more, cable (thru-beam type: both emitter and receiver)											
Weight			Net			Emitter: 45 g approx., Receiver: 50 g approx.			50 g approx.			60 g approx.		
			Gross			100 g approx.			80 g approx.			60 g approx.		
Accessories			RF-230 (Reflector): 1 pc.											

Notes: 1) Where measurement conditions have not been specified precisely, the conditions used were an ambient temperature of +23 °C +73.4 °F.  
 2) The sensing range and the sensing object of the retroreflective type sensor are specified for the RF-230 reflector. The sensing range represents the actual sensing range of the sensor. The sensing range : A of the table below may vary depending on the shape of sensing object. Be sure to check the operation with the actual sensing object.

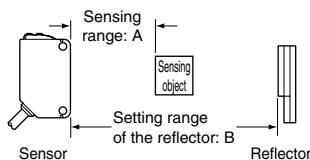

	CX-491□	CX-493□	CX-481□	CX-483□	CX-482□
A	0 to 3 m 0 to 9.843 ft	0 to 5 m 0 to 16.404 ft	50 to 500 mm 1.969 to 19.685 in	50 to 1,000 mm 1.969 to 39.37 in	0.1 to 2 m 0.328 to 6.562 ft
B	0.1 to 3 m 0.328 to 9.843 ft	0.1 to 5 m 0.328 to 16.404 ft	100 to 500 mm 3.937 to 19.685 in	100 to 1,000 mm 3.937 to 39.37 in	0.8 to 2 m 2.625 to 6.562 ft

3) The sensing range and hysteresis of the diffuse reflective type sensor are specified for white non-glossy paper (200 × 200 mm 7.874 × 7.874 in) as the object.  
 4) If slit masks (optional) are fitted, an object of ø0.5 mm ø0.020 in (using round slit mask) can be detected.  
 5) Make sure to confirm detection with an actual sensor before use.

## SPECIFICATIONS

### Standard type

Item	Model No.	Type	Adjustable range reflective				
		NPN output	CX-441	CX-443	CX-444	CX-442	
		PNP output	CX-441-P	CX-443-P	CX-444-P	CX-442-P	
CE marking directive compliance		EMC Directive, RoHS Directive					
Adjustable range (Note 2)		20 to 50 mm <b>0.787 to 1.969 in</b>		20 to 100 mm <b>0.787 to 3.937 in</b>	40 to 300 mm <b>1.575 to 11.811 in</b>		
Sensing range (with white non-glossy paper)		2 to 50 mm <b>0.079 to 1.969 in</b>		15 to 100 mm <b>0.591 to 3.937 in</b>	20 to 300 mm <b>0.787 to 11.811 in</b>		
Hysteresis (with white non-glossy paper)		2 % or less of operation distance				5 % or less of operation distance	
Repeatability		Along sensing axis: 1 mm <b>0.039 in</b> or less, Perpendicular to sensing axis: 0.2 mm <b>0.008 in</b> or less (with white non-glossy paper)					
Supply voltage		12 to 24 V DC $\pm 10$ % Ripple P-P 10 % or less					
Current consumption		20 mA or less					
Output		<NPN output type> NPN open-collector transistor			<PNP output type> PNP open-collector transistor		
		<ul style="list-style-type: none"> <li>Maximum sink current: 100 mA</li> <li>Applied voltage: 30 V DC or less (between output and 0 V)</li> <li>Residual voltage: 2 V or less (at 100 mA sink current)</li> </ul>			<ul style="list-style-type: none"> <li>Maximum source current: 100 mA</li> <li>Applied voltage: 30 V DC or less (between output and +V)</li> <li>Residual voltage: 2 V or less (at 100 mA source current)</li> </ul>		
		1 V or less (at 16 mA sink current)			1 V or less (at 16 mA source current)		
Output operation		Switchable either Detection-ON or Detection-OFF					
Short-circuit protection		Incorporated					
Response time		1 ms or less					
Operation indicator		Orange LED (lights up when the output is ON)					
Stability indicator		Green LED (lights up under stable operating condition)					
Distance adjuster		5-turn mechanical adjuster					
Sensing mode		BGS/FGS functions Switchable with wiring of sensing mode selection input					
Automatic interference prevention function (Note 3)		Incorporated					
Environmental resistance	Protection	IP67 (IEC)					
	Ambient temperature	-25 to +55 °C <b>-13 to +131 °F</b> (No dew condensation or icing allowed), Storage: -30 to +70 °C <b>-22 to +158 °F</b>					
	Ambient humidity	35 to 85 % RH, Storage: 35 to 85 % RH					
	Ambient illuminance	Incandescent light: 3,000 lx or less at the light-receiving face					
	Voltage withstandability	1,000 V AC for one min. between all supply terminals connected together and enclosure					
	Insulation resistance	20 MΩ, or more, with 250 V DC megger between all supply terminals connected together and enclosure					
	Vibration resistance	10 to 500 Hz frequency, 3 mm <b>0.118 in</b> double amplitude (20 G max) in X, Y and Z directions for two hours each					
Shock resistance	500 m/s <sup>2</sup> acceleration (50 G approx.) in X, Y and Z directions three times each						
Emitting element		Red LED (Peak emission wavelength: 650 nm <b>0.026 mil</b> , modulated)					
Spot diameter		ø2 mm <b>ø0.079 in</b> approx. (at 50 mm <b>1.969 in</b> distance)	ø6.5 mm <b>ø0.256 in</b> approx. (at 50 mm <b>1.969 in</b> distance)	ø9 mm <b>ø0.354 in</b> approx. (at 100 mm <b>3.937 in</b> distance)	ø15 mm <b>ø0.591 in</b> approx. (at 300 mm <b>11.811 in</b> distance)		
Material		Enclosure: PBT (Polybutylene terephthalate), Lens: Polycarbonate, Indicator cover: Polycarbonate					
Cable		0.2 mm <sup>2</sup> 4-core cabtyre cable, 2 m <b>6.562 ft</b> long					
Cable extension		Extension up to total 100 m <b>328.084 ft</b> is possible with 0.3 mm <sup>2</sup> , or more, cable.					
Weight		Net weight: 55 g approx., Gross weight: 65 g approx.					

Notes: 1) Where measurement conditions have not been specified precisely, the conditions used were an ambient temperature of +23 °C **+73.4 °F**.  
 2) The adjustable range stands for the maximum sensing range which can be set with the distance adjuster. The sensor can detect an object 2 mm **0.079 in** [CX-444(-P): 15 mm **0.591 in**, CX-442(-P): 20 mm **0.787 in**], or more, away.

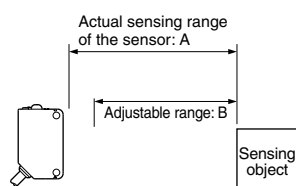

	CX-441□/443□	CX-444□	CX-442□
A	2 to 50 mm <b>0.079 to 1.969 in</b>	15 to 100 mm <b>0.591 to 3.937 in</b>	20 to 300 mm <b>0.787 to 11.811 in</b>
B	20 to 50 mm <b>0.787 to 1.969 in</b>	20 to 100 mm <b>0.787 to 3.937 in</b>	40 to 300 mm <b>1.575 to 11.811 in</b>

3) Note that detection may be unstable depending on the mounting conditions or the sensing object. In the state that this product is mounted, be sure to check the operation with the actual sensing object.

## SPECIFICATIONS

### Basic type

Item	Model No.	Type	Thru-beam				Retroreflective			
					Long sensing range		With polarizing filters			
			Light-ON	Dark-ON	Light-ON	Dark-ON	Light-ON	Dark-ON		
		NPN output	<b>CX-411A-C05</b>	<b>CX-411B-C05</b>	<b>CX-412A-C05</b>	<b>CX-412B-C05</b>	<b>CX-491A-C05-Y</b>	<b>CX-491B-C05-Y</b>		
		PNP output	<b>CX-411A-P-C05</b>	<b>CX-411B-P-C05</b>	<b>CX-412A-P-C05</b>	<b>CX-412B-P-C05</b>	<b>CX-491A-P-C05-Y</b>	<b>CX-491B-P-C05-Y</b>		
CE marking directive compliance			EMC Directive, RoHS Directive							
Sensing range			10 m <b>32.808 ft</b>		15 m <b>49.213 ft</b>		3 m <b>9.843 ft</b> (Note 2)			
Sensing object			ø12 mm <b>ø0.472 in</b> or more opaque object (Note 3)				ø50 mm <b>ø1.969 in</b> or more transparent, translucent or opaque object (Note 2, 4)			
Hysteresis			—							
Repeatability (perpendicular to sensing axis)			0.5 mm <b>0.020 in</b> or less							
Supply voltage			12 to 24 V DC ±10 % Ripple P-P 10 % or less							
Current consumption			Emitter: 15 mA or less Receiver: 10 mA or less		Emitter: 20 mA or less Receiver: 10 mA or less		13 mA or less			
Output			<NPN output type> NPN open-collector transistor • Maximum sink current: 100 mA • Applied voltage: 30 V DC or less (between output and 0 V) • Residual voltage: 2 V or less (at 100 mA sink current) 1 V or less (at 16 mA sink current)				<PNP output type> PNP open-collector transistor • Maximum source current: 100 mA • Applied voltage: 30 V DC or less (between output and +V) • Residual voltage: 2 V or less (at 100 mA source current) 1 V or less (at 16 mA source current)			
Short-circuit protection			Incorporated							
Response time			1 ms or less							
Operation indicator			Orange LED (lights up when the output is ON)(incorporated on the receiver for thru-beam type)							
Stability indicator			Green LED (lights up under stable light received condition or stable dark condition)(incorporated on the receiver for thru-beam type)							
Power indicator			Green LED (lights up when the power is ON) (incorporated on the emitter)				—			
Sensitivity adjuster			—							
Automatic interference prevention function			[ Two units of sensors can be mounted close together with interference prevention filters. (Sensing range: 5 m <b>16.404 ft</b> ) ]		—		Incorporated (Two units of sensors can be mounted close together.)			
Environmental resistance	Protection		IP67 (IEC)							
	Ambient temperature		-25 to +55 °C <b>-13 to +131 °F</b> (No dew condensation or icing allowed), Storage: -30 to +70 °C <b>-22 to +158 °F</b>							
	Ambient humidity		35 to 85 % RH, Storage: 35 to 85 % RH							
	Ambient illuminance		Incandescent light: 3,000 lx or less at the light-receiving face							
	Voltage withstandability		1,000 V AC for one min. between all supply terminals connected together and enclosure							
	Insulation resistance		20 MΩ, or more, with 250 V DC megger between all supply terminals connected together and enclosure							
	Vibration resistance		10 to 500 Hz frequency, 1.5 mm <b>0.059 in</b> double amplitude (10 G max.) in X, Y and Z directions for two hours each							
	Shock resistance		500 m/s <sup>2</sup> acceleration (50 G approx.) in X, Y and Z directions three times each							
Emitting element (modulated)			Red LED		Infrared LED		Red LED			
Peak emission wavelength			680 nm <b>0.027 mil</b>		870 nm <b>0.034 mil</b>		680 nm <b>0.027 mil</b>			
Material			Enclosure: PBT (Polybutylene terephthalate), Lens: Acrylic, Indicator cover: Acrylic							
Cable			0.2 mm <sup>2</sup> 3-core (thru-beam type emitter: 2-core) cabtyre cable, 0.5 m <b>1.640 ft</b> long							
Cable extension			Extension up to total 100 m <b>328.084 ft</b> is possible with 0.3 mm <sup>2</sup> , or more, cable (thru-beam type: both emitter and receiver)							
Weight	Net		Emitter: 20 g approx., Receiver: 20 g approx.				20 g approx.			
	Gross		50 g approx.				30 g approx.			

Notes: 1) Where measurement conditions have not been specified precisely, the conditions used were an ambient temperature of +23 °C **+73.4 °F**.

2) The sensing range and the sensing object of the retroreflective type sensor are specified for the **RF-230** reflector (optional). The sensing range represents the actual sensing range of the sensor. The sensing range : A of the table below may vary depending on the shape of sensing object. Be sure to check the operation with the actual sensing object.

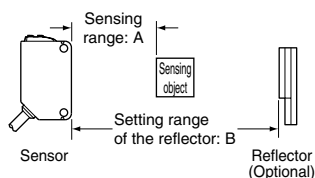

	<b>CX-491□</b>
A	0 to 3 m <b>0 to 9.843 ft</b>
B	0.1 to 3 m <b>0.328 to 9.843 ft</b>

3) If slit masks (optional) are fitted, an object of ø0.5 mm **ø0.020 in** (using round slit mask) can be detected.

4) Make sure to confirm detection with an actual sensor before use.

## I/O CIRCUIT AND WIRING DIAGRAMS

### NPN output type

#### I/O circuit diagram

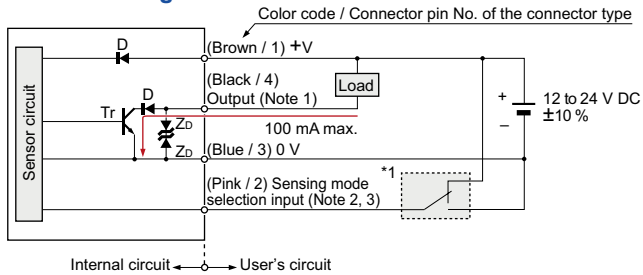

- Notes: 1) The emitter of the thru-beam type sensor does not incorporate the output.  
2) Sensing mode selection input is incorporated only for the **CX-44** adjustable range reflective type. When using the **CX-44**, be sure to wire the sensing mode selection input (pink / 2) as mentioned \*1. Unstable operation may occur.  
3) When the mating cable is connected to the plug-in connector type of **CX-44**, its color is white.

\*1

- Sensing mode selection input  
BGS function: Connect to 0 V  
FGS function: Connect to +V

Symbols ... D : Reverse supply polarity protection diode  
Z<sub>D</sub> : Surge absorption zener diode  
Tr : NPN output transistor

#### Wiring diagram

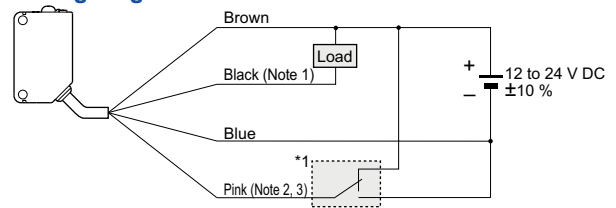

- Notes: 1) The emitter of the thru-beam type sensor does not incorporate the black wire.  
2) The pink wire is incorporated only for the **CX-44** adjustable range reflective type. When using the **CX-44**, be sure to wire the pink wire as mentioned \*1. Unstable operation may occur.  
3) When the mating cable is connected to the plug-in connector type of **CX-44**, its color is white.

\*1

- Sensing mode selection input  
BGS function: Connect to 0 V  
FGS function: Connect to +V

#### Connector pin position

##### M8 plug-in connector type

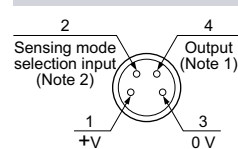

##### M12 pigtailed type

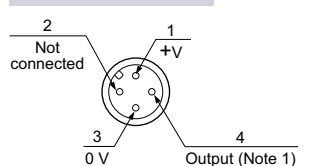

- Notes: 1) The emitter of the thru-beam type sensor does not incorporate the output.  
2) Sensing mode selection input is incorporated only for the **CX-44** adjustable range reflective type. When using the **CX-44**, be sure to wire the sensing mode selection input (pink / 2). Unstable operation may occur.

### PNP output type

#### I/O circuit diagram

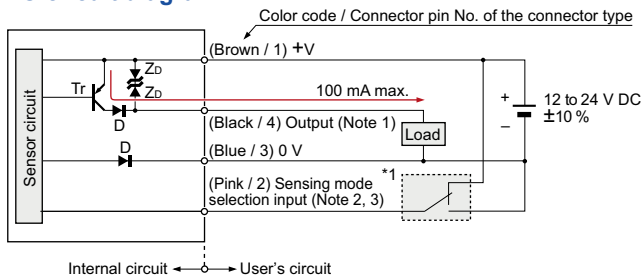

- Notes: 1) The emitter of the thru-beam type sensor does not incorporate the output.  
2) Sensing mode selection input is incorporated only for the **CX-44-P** adjustable range reflective type. When using the **CX-44-P**, be sure to wire the sensing mode selection input (pink / 2) as mentioned \*1. Unstable operation may occur.  
3) When the mating cable is connected to the plug-in connector type of **CX-44-P**, its color is white.

\*1

- Sensing mode selection input  
BGS function: Connect to 0 V  
FGS function: Connect to +V

Symbols ... D : Reverse supply polarity protection diode  
Z<sub>D</sub> : Surge absorption zener diode  
Tr : PNP output transistor

#### Wiring diagram

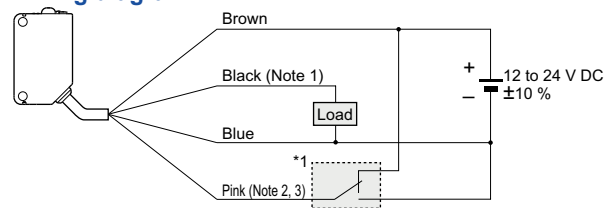

- Notes: 1) The emitter of the thru-beam type sensor does not incorporate the output.  
2) The pink wire is incorporated only for the **CX-44-P** adjustable range reflective type. When using the **CX-44-P**, be sure to wire the pink wire as mentioned \*1. Unstable operation may occur.  
3) When the mating cable is connected to the plug-in connector type of **CX-44-P**, its color is white.

\*1

- Sensing mode selection input  
BGS function: Connect to 0 V  
FGS function: Connect to +V

#### Connector pin position

##### M8 plug-in connector type

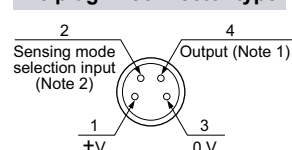

##### M12 pigtailed type

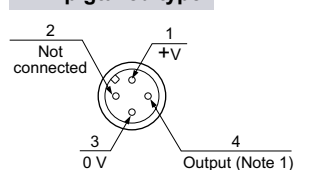

- Notes: 1) The emitter of the thru-beam type sensor does not incorporate the output.  
2) Sensing mode selection input is incorporated only for the **CX-44-P** adjustable range reflective type. When using the **CX-44-P**, be sure to wire the sensing mode selection input (pink / 2). Unstable operation may occur.

**SENSING CHARACTERISTICS (TYPICAL)**

**CX-411□**

Thru-beam type

**Parallel deviation**

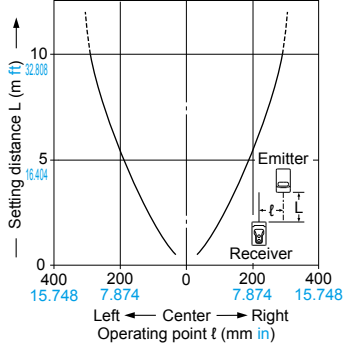

**Angular deviation**

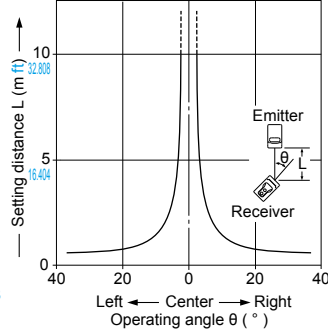

**Parallel deviation with round slit masks (ø0.5 mm ø0.020 in)**

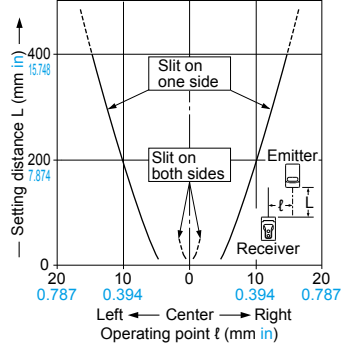

**Parallel deviation with round slit masks (ø1 mm ø0.039 in)**

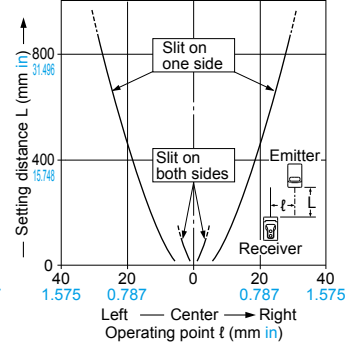

**Parallel deviation with round slit masks (ø2 mm ø0.079 in)**

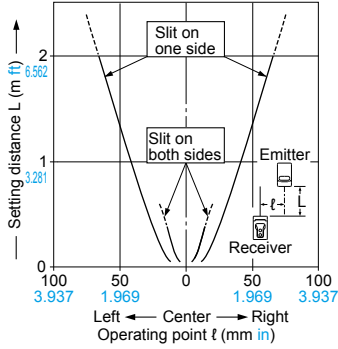

**Parallel deviation with rectangular slit masks (0.5 × 6 mm 0.020 × 0.236 in)**

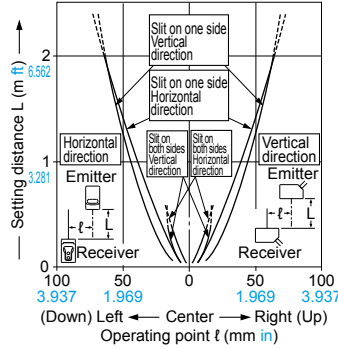

**Parallel deviation with rectangular slit masks (1 × 6 mm 0.039 × 0.236 in)**

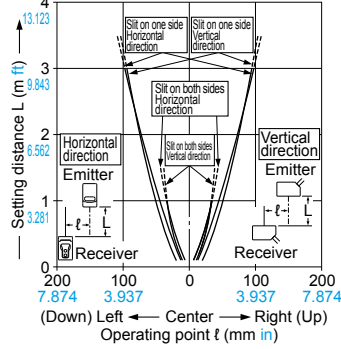

**Parallel deviation with rectangular slit masks (2 × 6 mm 0.079 × 0.236 in)**

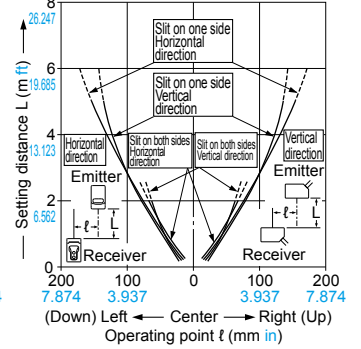

**CX-412□**

Thru-beam type

**Parallel deviation**

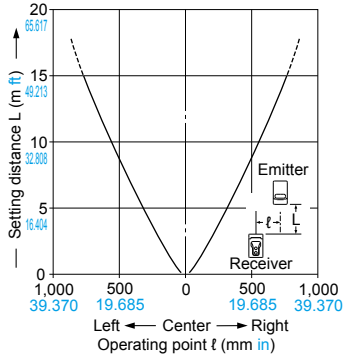

**Angular deviation**

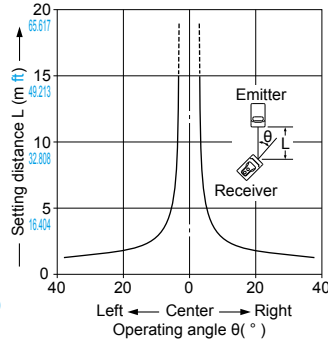

**Parallel deviation with round slit masks (ø0.5 mm ø0.020 in)**

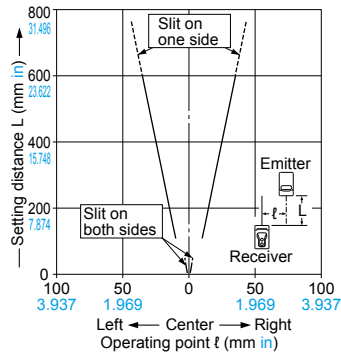

**Parallel deviation with round slit masks (ø1 mm ø0.039 in)**

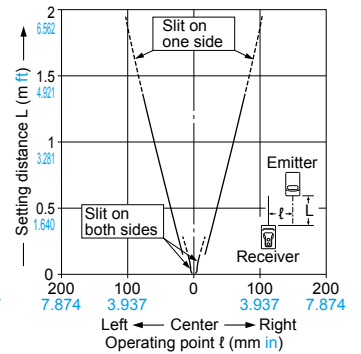

**Parallel deviation with round slit masks (ø2 mm ø0.079 in)**

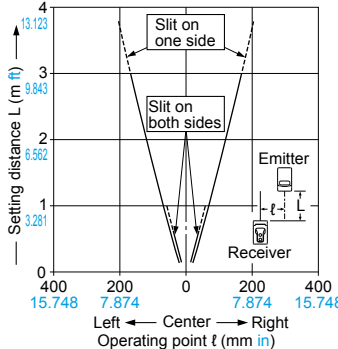

**Parallel deviation with rectangular slit masks (0.5 × 6 mm 0.020 × 0.236 in)**

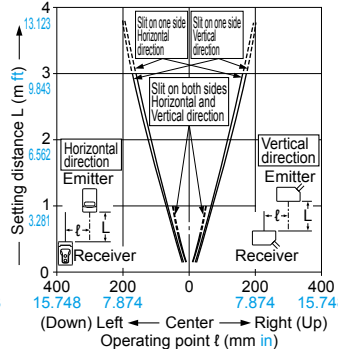

**Parallel deviation with rectangular slit masks (1 × 6 mm 0.039 × 0.236 in)**

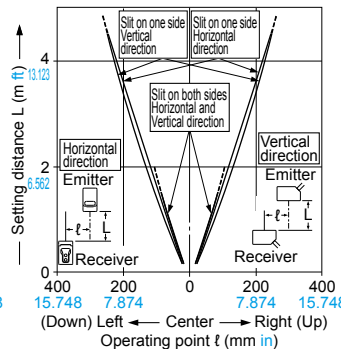

**Parallel deviation with rectangular slit masks (2 × 6 mm 0.079 × 0.236 in)**

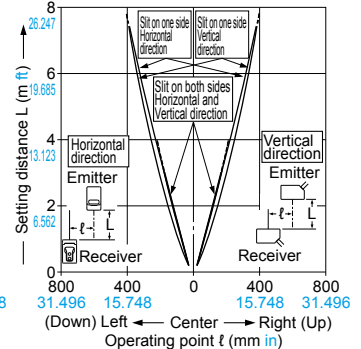



**SENSING CHARACTERISTICS (TYPICAL)**

**CX-491□**

Retroreflective type

Parallel deviation

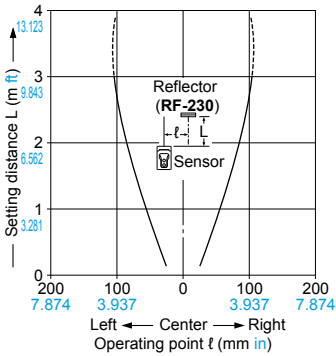

Angular deviation

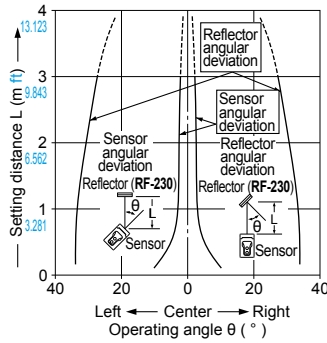

**CX-493□**

Retroreflective type

Parallel deviation

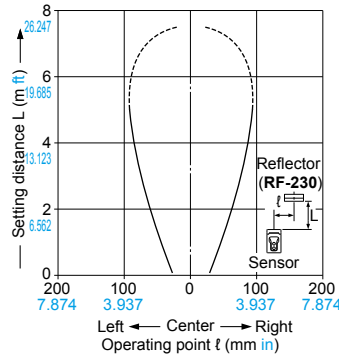

Angular deviation

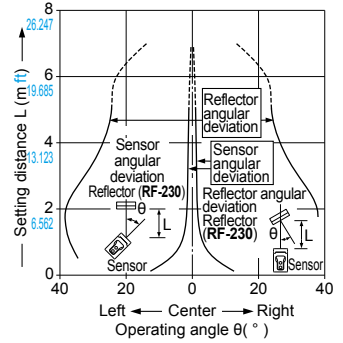

**CX-481□**

Retroreflective type

Parallel deviation

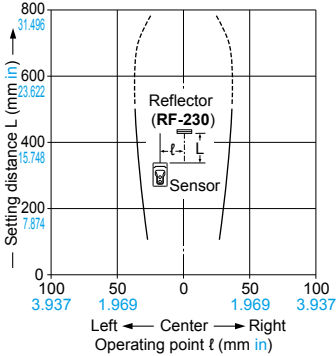

Angular deviation

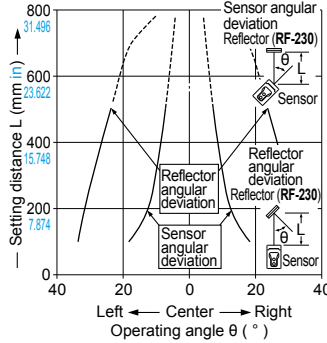

**CX-482□**

Retroreflective type

Parallel deviation

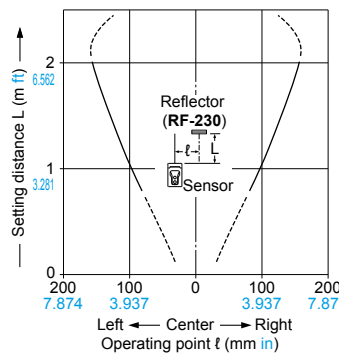

Angular deviation

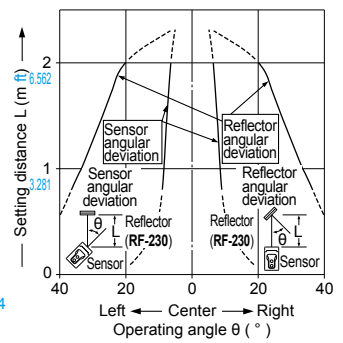

**CX-424□**

Diffuse reflective type

Sensing field

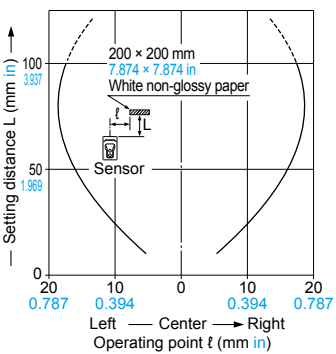

Correlation between sensing object size and sensing range

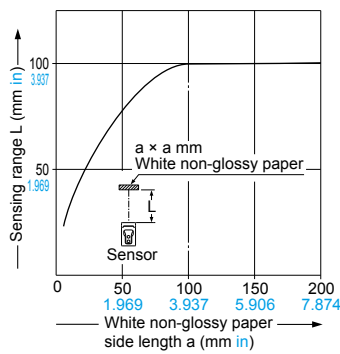

As the sensing object size becomes smaller than the standard size (white non-glossy paper 200 × 200 mm 7.874 × 7.874 in), the sensing range shortens, as shown in the left graph.

(For plotting the left graph, the sensitivity has been set such that a 200 × 200 mm 7.874 × 7.874 in white non-glossy paper is just detectable at a distance of 100 mm 3.937 in.)

**CX-421□**

Diffuse reflective type

Sensing field

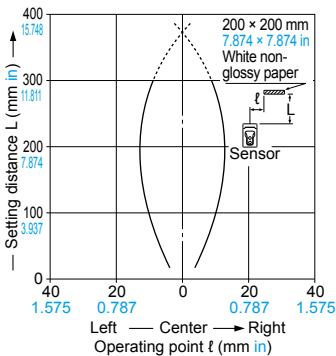

Correlation between sensing object size and sensing range

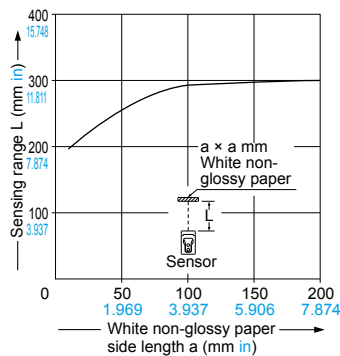

As the sensing object size becomes smaller than the standard size (white non-glossy paper 200 × 200 mm 7.874 × 7.874 in), the sensing range shortens, as shown in the left graph.

(For plotting the left graph, the sensitivity has been set such that a 200 × 200 mm 7.874 × 7.874 in white non-glossy paper is just detectable at a distance of 300 mm 11.811 in.)

**SENSING CHARACTERISTICS (TYPICAL)**

**CX-422□**

Diffuse reflective type

**Sensing field**

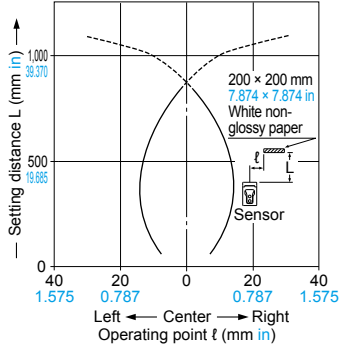

**Correlation between sensing object size and sensing range**

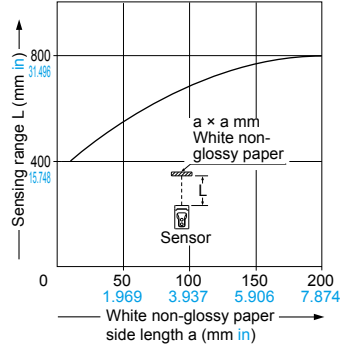

As the sensing object size becomes smaller than the standard size (white non-glossy paper 200 × 200 mm 7.874 × 7.874 in), the sensing range shortens, as shown in the left graph.

(For plotting the left graph, the sensitivity has been set such that a 200 × 200 mm 7.874 × 7.874 in white non-glossy paper is just detectable at a distance of 800 mm 31.496 in.)

**CX-423□**

Diffuse reflective type

**Sensing field**

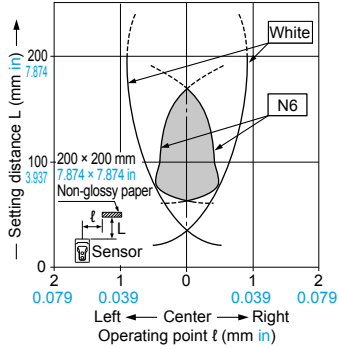

**Correlation between sensing object size and sensing range**

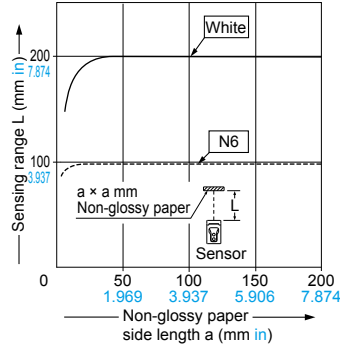

As the sensing object size becomes smaller than the standard size (white non-glossy paper 200 × 200 mm 7.874 × 7.874 in), the sensing range shortens, as shown in the left graph.

(For plotting the left graph, the sensitivity has been set such that a 200 × 200 mm 7.874 × 7.874 in white non-glossy paper is just detectable at a distance of 200 mm 7.874 in. Contact us for the sensing characteristics of 300 mm 11.811 in distance. Please contact us for the sensing field at the setting distance 300 mm 11.811 in.)

**Correlation between lightness and sensing range**

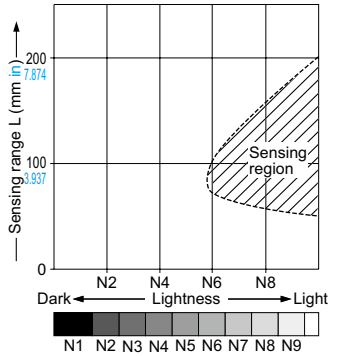

The sensing region is represented by oblique lines in the left figure. However, the sensitivity should be set with an enough margin because of slight variation in products.

(Lightness shown on the left may differ slightly from the actual object condition.)

**Emitted beam**

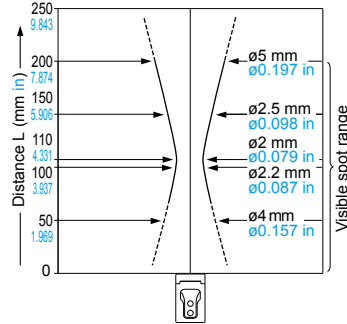

**SENSING CHARACTERISTICS (TYPICAL)**

**CX-441□**

Adjustable range reflective type

**Sensing fields**

• Setting distance: 25 mm 0.984 in

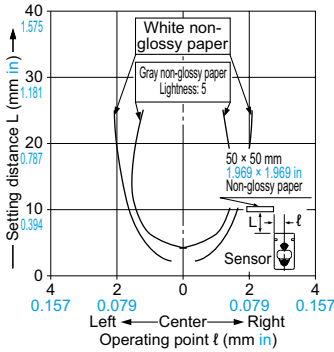

• Setting distance: 50 mm 1.969 in

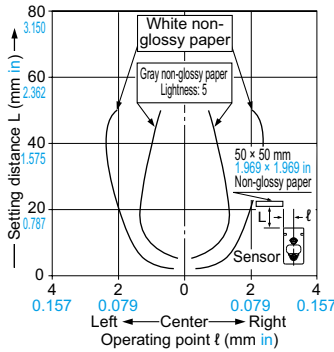

**Emitted beam**

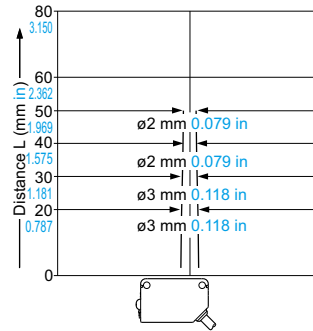

**Correlation between color**

(50 × 50 mm 1.969 × 1.969 in construction paper) and sensing range

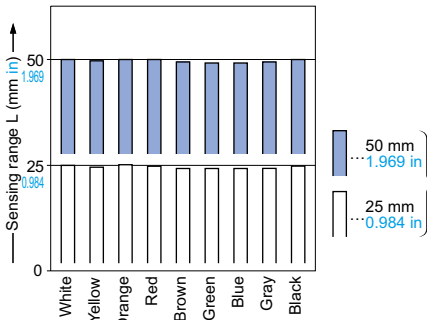

These bars indicate the sensing range with the respective colors when the distance adjuster is set to a sensing range of 50 mm 1.969 in and 25 mm 0.984 in long, respectively, with white color. The sensing range also varies depending on material.

**Correlation between material**

(50 × 50 mm 1.969 × 1.969 in) and sensing range

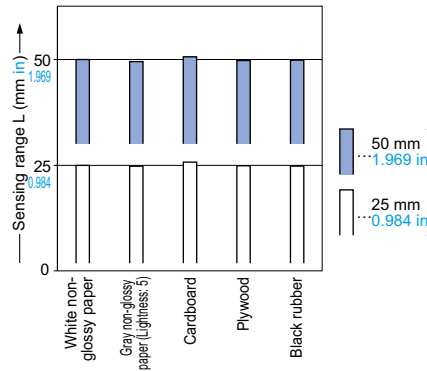

These bars indicate the sensing range with the respective objects when the distance adjuster is set to a sensing range of 50 mm 1.969 in and 25 mm 0.984 in long, respectively, with white non-glossy paper.

**CX-443□**

Adjustable range reflective type

**Sensing fields**

• Setting distance: 25 mm 0.984 in

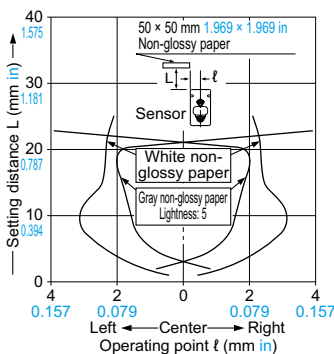

• Setting distance: 50 mm 1.969 in

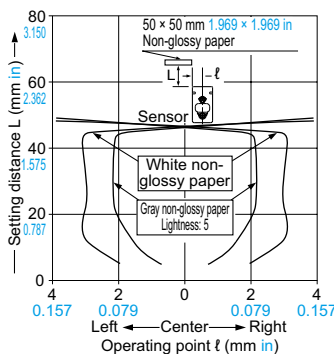

**Emitted beam**

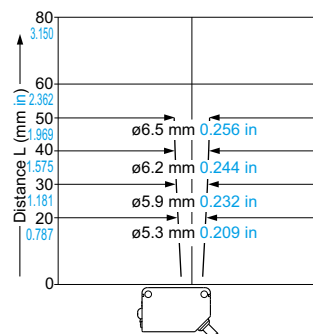

**Correlation between color**

(50 × 50 mm 1.969 × 1.969 in construction paper) and sensing range

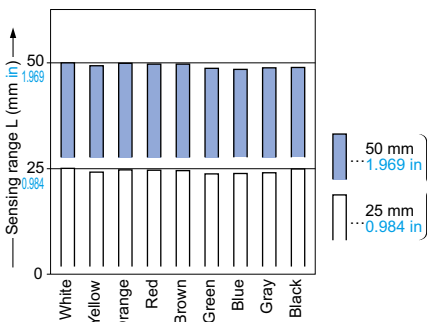

These bars indicate the sensing range with the respective colors when the distance adjuster is set to a sensing range of 50 mm 1.969 in and 25 mm 0.984 in long, respectively, with white color. The sensing range also varies depending on material.

**Correlation between material**

(50 × 50 mm 1.969 × 1.969 in) and sensing range

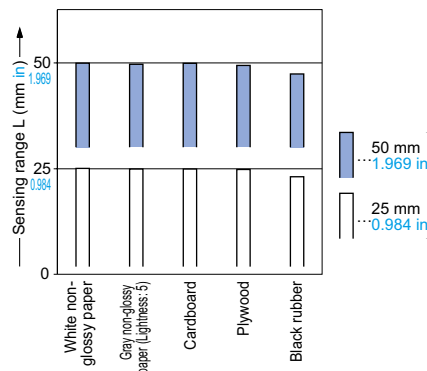

These bars indicate the sensing range with the respective objects when the distance adjuster is set to a sensing range of 50 mm 1.969 in and 25 mm 0.984 in long, respectively, with white non-glossy paper.

**SENSING CHARACTERISTICS (TYPICAL)**

**CX-444□**

Adjustable range reflective type

**Sensing fields**

• Setting distance: 25 mm 0.984 in

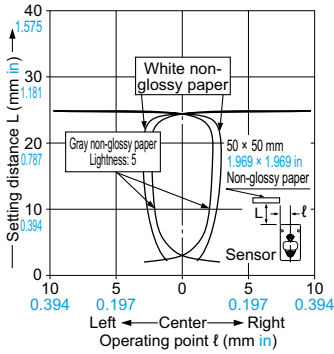

• Setting distance: 50 mm 1.969 in

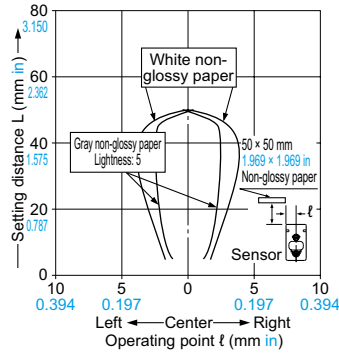

• Setting distance: 100 mm 3.937 in

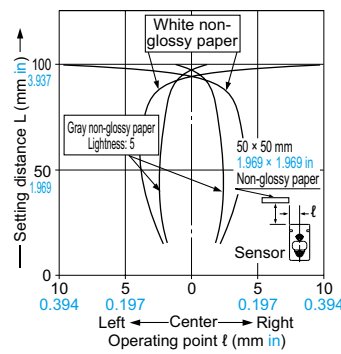

**Emitted beam**

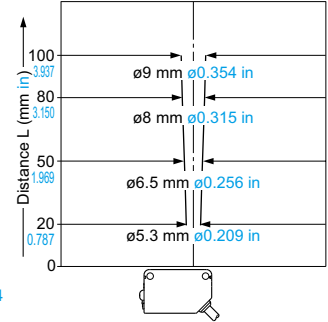

**Correlation between color**

(50 × 50 mm 1.969 × 1.969 in construction paper) and sensing range

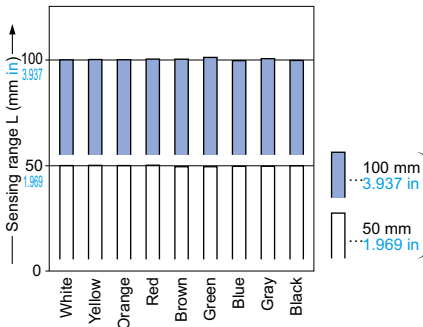

These bars indicate the sensing range with the respective colors when the distance adjuster is set to a sensing range of 100 mm 3.937 in and 50 mm 1.969 in long, respectively, with white color. The sensing range also varies depending on material.

**Correlation between material**

(50 × 50 mm 1.969 × 1.969 in) and sensing range

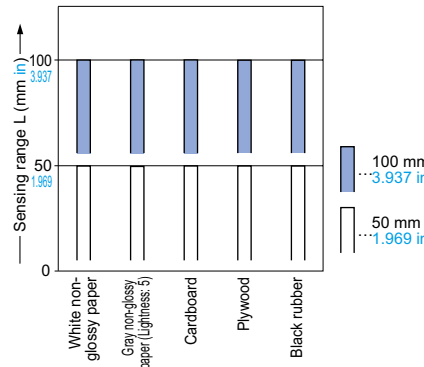

These bars indicate the sensing range with the respective objects when the distance adjuster is set to a sensing range of 100 mm 3.937 in and 50 mm 1.969 in long, respectively, with white non-glossy paper.

**CX-442□**

Adjustable range reflective type

**Sensing fields**

• Setting distance: 100 mm 3.937 in

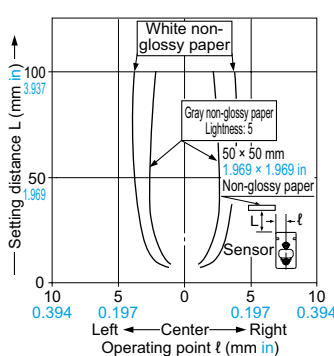

• Setting distance: 200 mm 7.874 in

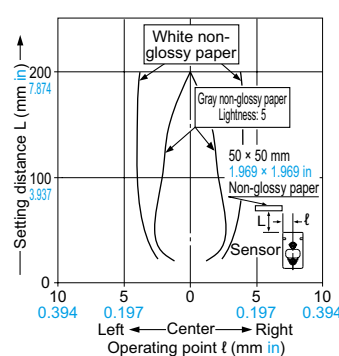

• Setting distance: 300 mm 11.811 in

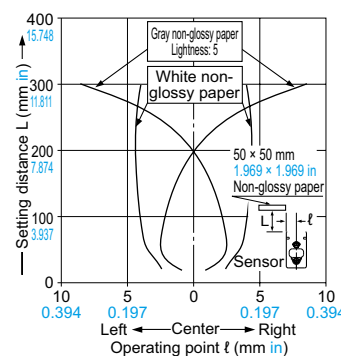

**Emitted beam**

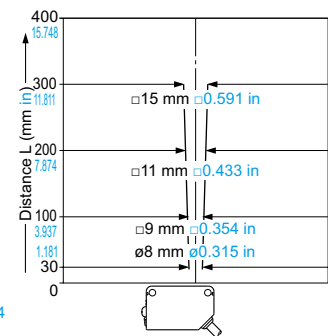

**Correlation between color**

(50 × 50 mm 1.969 × 1.969 in construction paper) and sensing range

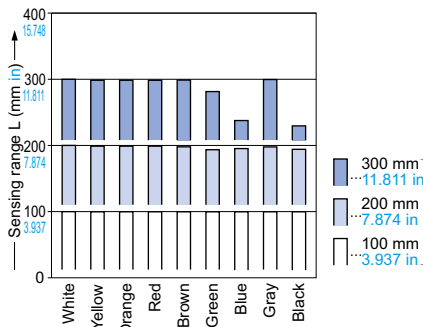

These bars indicate the sensing range with the respective colors when the distance adjuster is set to a sensing range of 300 mm 11.811 in, 200 mm 7.874 in and 100 mm 3.937 in long, respectively, with white color. The sensing range also varies depending on material.

**Correlation between material**

(50 × 50 mm 1.969 × 1.969 in) and sensing range

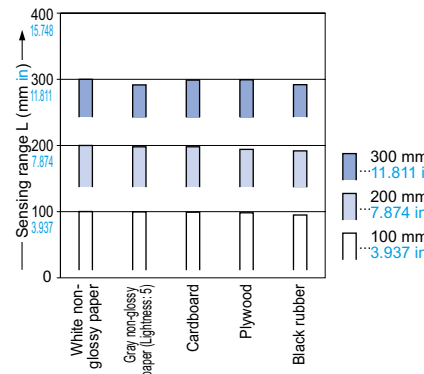

These bars indicate the sensing range with the respective objects when the distance adjuster is set to a sensing range of 300 mm 11.811 in, 200 mm 7.874 in and 100 mm 3.937 in long, respectively, with white non-glossy paper.

## PRECAUTIONS FOR PROPER USE

### All models



- Never use this product as a sensing device for personnel protection.
- In case of using sensing devices for personnel protection, use products which meet laws and standards, such as OSHA, ANSI or IEC etc., for personnel protection applicable in each region or country.

### Mounting

- The tightening torque should be 0.5 N·m or less.

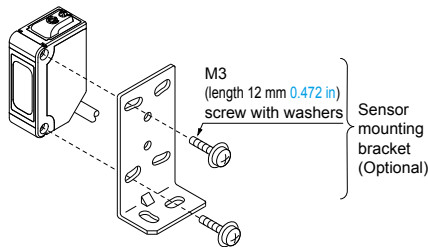

### Others

- Do not use during the initial transient time (50 ms) after the power supply is switched on.

### CX-41 □ CX-42 □ CX-49 □ CX-48 □

#### Part description and functions

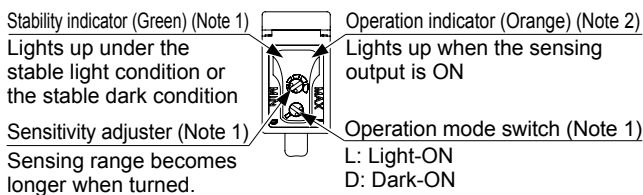

- Notes: 1) Not incorporated on the emitter.  
2) It is the power indicator (green, lights up when the power is ON.) on the emitter.

#### Operation mode switch

Operation mode switch	Description
	Light-ON mode is obtained when the operation mode switch (thru-beam type incorporate it in the receiver) is turned fully clockwise (L side).
	Dark-ON mode is obtained when the operation mode switch (thru-beam type incorporate it in the receiver) is turned fully counter-clockwise (D side).

#### Beam alignment

##### Thru-beam type

1. Set the operation mode switch to the Light-ON mode position (L side).
2. Place the emitter and the receiver face to face along a straight line, move the emitter in the up, down, left and right directions, in order to determine the range of the light received condition with the help of the operation indicator (orange). Then, set the emitter at the center of this range.
3. Similarly, adjust for up, down, left and right angular movement of the emitter.
4. Further, perform the angular adjustment for the receiver also.
5. Check that the stability indicator (green) lights up.
6. Choose the operation mode, Light-ON or Dark-ON, as per your requirement, with the operation mode switch.

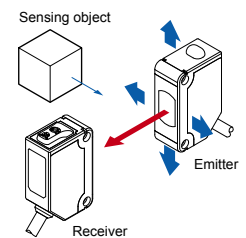

##### Retroreflective type

1. Set the operation mode switch to the Light-ON mode position (L side).
2. Placing the sensor and the reflector face to face along a straight line, move the reflector in the up, down, left and right directions, in order to determine the range of the light received condition with the help of the operation indicator (orange). Then, set the reflector at the center of this range.
3. Similarly, adjust for up, down, left and right angular movement of the reflector.
4. Further, perform the angular adjustment for the sensor also.
5. Check that the stability indicator (green) lights up.
6. Choose the operation mode, Light-ON or Dark-ON, as per your requirement, with the operation mode switch.

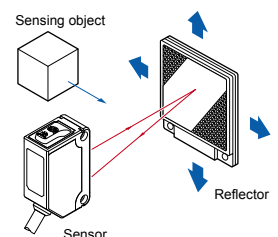

## PRECAUTIONS FOR PROPER USE

CX-41□ CX-42□ CX-49□ CX-48□

### Sensitivity adjustment

Step	Sensitivity adjuster	Description
①		Turn the sensitivity adjuster fully counterclockwise to the minimum sensitivity position, MIN.
②		In the light received condition, turn the sensitivity adjuster slowly clockwise and confirm the point (A) where the sensor enters the "Light" state operation.
③		In the dark condition, turn the sensitivity adjuster further clockwise until the sensor enters the "Light" state operation and then bring it back to confirm point (B) where the sensor just returns to the "Dark" state operation. (If the sensor does not enter the "Light" state operation even when the sensitivity adjuster is turned fully clockwise, the position is point (B).)
④		The position at the middle of points (A) and (B) is the optimum sensing position.

Note: Use the flathead screwdriver (purchase separately) to turn the adjuster slowly. Turning with excessive strength will cause damage to the adjuster.

	Light condition	Dark condition
Thru-beam type		
Retroreflective type		
Diffuse reflective type		

### Relation between output and indicators

In case of Light-ON			Sensing condition	In case of Dark-ON		
Stability indicator	Operation indicator	Output		Output	Operation indicator	Stability indicator
●	●	ON	Stable light receiving	OFF	●	●
●	●	ON	Unstable light receiving	OFF	●	●
●	●	OFF	Unstable dark receiving	ON	●	●
●	●	OFF	Stable dark receiving	ON	●	●

●, ●: Lights up, ●: Turns OFF

### Retroreflective type sensor (excluding CX-491□)

- Please take care of the following points when detecting materials having a gloss.

- Make L, shown in the diagram, sufficiently long.
- Install at an angle of 10 to 30 degrees to the sensing object.

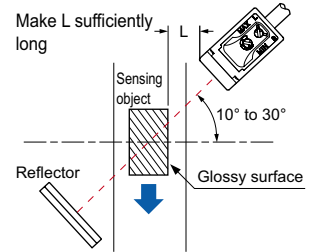

### Retroreflective type sensor with polarizing filters (CX-491□)

- If a shiny object is covered or wrapped with a transparent film, such as those described below, the retroreflective type sensor with polarizing filters may not be able to detect it. In that case, follow the steps given below.

#### Example of sensing objects

- Can wrapped by clear film
- Aluminum sheet covered by plastic film
- Gold or silver color (specular) label or wrapping paper

#### Steps

- Tilt the sensor with respect to the sensing object while fitting.
- Reduce the sensitivity.
- Increase the distance between the sensor and the sensing object.

### CX-48□

### Retroreflective type sensor for transparent object sensing (CX-48□)

- Optimum sensing is possible when the position of the transparent sensing object is set at the center of the sensor and the reflector. If the sensing position is set near the sensor or the reflector, the sensing may be unstable. In this case, set the sensing position at the center of the sensor and the reflector.

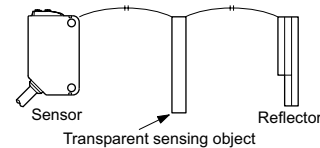

- When the sensor detects an uneven plastic receptacle or glass bottle, the received-light amount may differ with the sensing position or direction. Adjust the sensitivity after confirming the stable sensing condition by turning the sensing object, etc.
- When sensing pipe-shaped transparent sensing object, set it in a standing, not lying, position as shown in Figure A. The sensor may fail to detect a lying object as shown in Figure B.

#### Correct

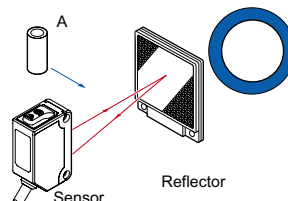

#### Incorrect

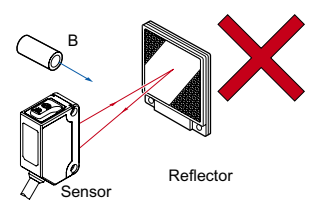

## PRECAUTIONS FOR PROPER USE

### CX-41□

#### Slit mask (Optional)

- With the slit mask **OS-CX-□**, the sensor can detect a small object. However, the sensing range is reduced when the slit mask is mounted.

#### How to mount

- Insert the fixing hook into the fixing groove.
- Then, pressing the slit mask against the main unit, insert the fixing tab into the fixing groove.

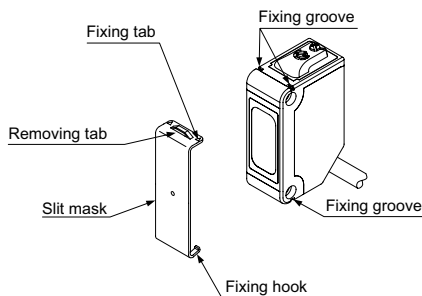

#### How to remove

- Insert a screwdriver into the removing tab.
- Pull forward while lifting the removing tab.

#### Interference prevention filter (CX-411□)

- By mounting the interference prevention filters **PF-CX4-□**, two sets of the **CX-411□** can be mounted close together. However, the sensing range is reduced when the interference prevention filter is mounted.
- The filters can be mounted by the same method as for the slit masks.
- Since there are two types of the interference prevention filter, the two sets of sensors should be fitted with different types of interference prevention filters, as shown in the figure below. The interference prevention does not work even if the filters are mounted for emitters only, receivers only or the same model No. of the interference prevention filters are mounted on both the sets of the sensor.

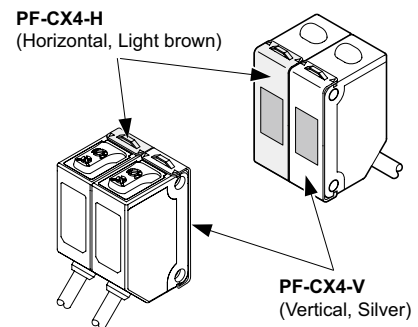

### CX-44□

#### Mounting

- Care must be taken regarding the sensor mounting direction with respect to the object's direction of movement.

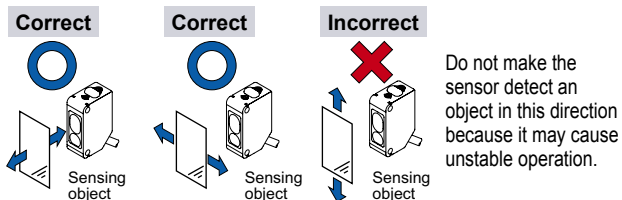

- When detecting a specular object (aluminum or copper foil, etc.) or an object having a glossy surface or coating, please take care that there are cases when the object may not be detected due to a change in angle, wrinkles on the object surface, etc.
- When a specular body is present below the sensor, use the sensor by tilting it slightly upwards to avoid wrong operation.

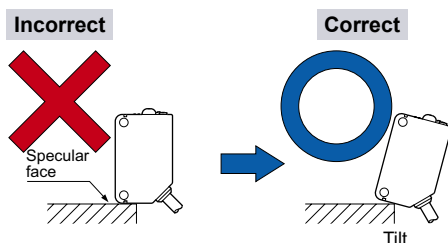

- If a specular body is present in the background, wrong operation may be caused due to a small change in the angle of the background body. In that case, install the sensor at an inclination and confirm the operation with the actual sensing object.
- Take care that there is a non-detectable area right in front of the sensor.

#### Operation mode switch

Operation mode switch	Description
	Detecting-ON mode is obtained when the operation mode switch is turned fully clockwise (L side).
	Not detecting-ON is obtained when the operation mode switch is turned fully counterclockwise (D side).

Note: Use the flathead screwdriver (purchase separately) to turn the operation mode switch slowly. Turning with excessive strength will cause damage to the adjuster.

- Depending on whether you select the BGS or FGS function, the output operation changes as follows.

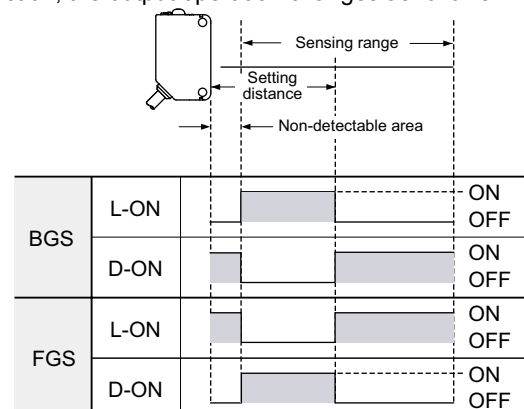

## PRECAUTIONS FOR PROPER USE

### CX-44□

#### Stability indicator

- Since the **CX-44**□ use a 2-segment photodiode as its receiving element, and sensing is done based on the difference in the incident beam angle of the reflected beam from the sensing object, the output and the operation indicator (orange) operate according to the object distance.
- Further, the stability indicator (green) shows the margin to the setting distance.

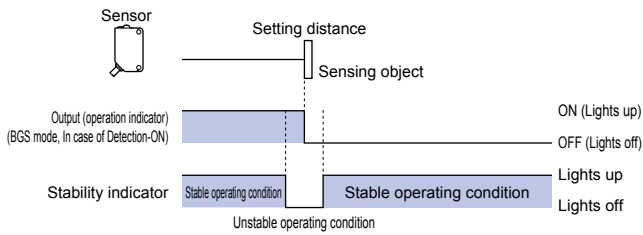

#### BGS/FGS functions

- This sensor incorporates BGS/FGS functions. Select either BGS or FGS function depending on the positions of the background and sensing object.

#### BGS function

- This function is used when the sensing object is apart from the background.

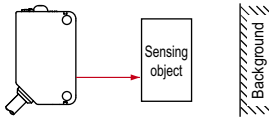

#### FGS function

- This function is used when the sensing object contacts the background or the sensing object is glossy, etc.
- Please use the FGS function together with a conveyor or other background unit.

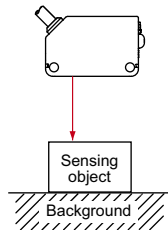

#### Distance adjustment



- When this product is used, be sure to carry out the distance adjustment.
- Since the distance adjuster of this sensor is a 5-turn adjuster, when the point (A) and (B) is adjusted as explained in the table right, there may be more than 1 turn between the point (A) and (B). Therefore, make sure to remember the turns of both points to find the optimum position.
- Be sure to wire the sensing mode selection input (Pink / 2) before distance adjustment. If the wiring is done after the distance adjustment, the sensing area is changed.

- Turn the distance adjuster gradually and lightly with a “minus” screwdriver (purchase separately). In order to protect itself, the distance adjuster idles if turned fully. If the adjuster is idled when distance adjustment is done, carry out the adjustment again.

#### When using the BGS function

##### <When a sensing object is moving right or left to the sensor>

Step	Description	Distance adjuster
①	Turn the distance adjuster fully counterclockwise to the minimum sensing range position. ( <b>CX-441</b> □/ <b>443</b> □/ <b>444</b> □: 20 mm <b>0.787 in</b> approx., <b>CX-442</b> □: 40 mm <b>1.575 in</b> approx.)	 Turn fully
②	Place an object at the required distance from the sensor, turn the distance adjuster gradually clockwise, and find out point (A) where the sensor changes to the detecting condition.	
③	Remove the object, turn the adjuster clockwise further until the sensor goes into the detecting state again. Once it has entered, turn the distance adjuster backward until the sensor returns to the non-detecting condition. This position is designated as point (B). When the sensor does not go into the detecting condition even if the adjuster is turned fully clockwise, the position where the adjuster was fully turned is regarded as the point (B). (There may be more than 1 turn between point (A) and (B), since this sensor incorporates a 5-turn adjuster.)	
④	The optimum position to stably detect objects is the center point between (A) and (B).	

##### <When a sensing object is approaching / moving away from the sensor>

- Follow only steps ① and ②. Since the sensing point may change depending on the sensing object, be sure to check the operation with the actual sensing object.

#### When using the FGS function

- Please use the FGS function together with a conveyor or other background unit.

Step	Description	Distance adjuster
①	Turn the distance adjuster fully clockwise to the maximum sensing range position. ( <b>CX-441</b> □/ <b>443</b> □: 50 mm <b>1.969 in</b> approx., <b>CX-444</b> □: 100 mm <b>3.937 in</b> approx., <b>CX-442</b> □: 300 mm <b>11.811 in</b> approx.)	 Turn fully
②	In the state where the sensor detects the background, turn the distance adjuster gradually counterclockwise, and find out point (A) where the sensor changes to the non-detecting condition.	
③	Place an object at the required distance from the sensor, turn the adjuster counterclockwise further until the sensor goes into the non-detecting condition again. Once entered, turn the distance adjuster backward until the sensor returns to the detecting condition. This position is designated as point (B). When the sensor does not go into the non-detecting condition even if the adjuster is turned fully counterclockwise, the position where the adjuster was fully turned is regarded as the point (B). (There may be more than 1 turn between point (A) and (B), since this sensor incorporates a 5-turn adjuster.)	
④	The optimum position to stably detect objects is the center point between (A) and (B).	

#### Others

- Its distance adjuster is mechanically operated. Do not drop; avoid other shocks.



**DIMENSIONS (Unit: mm in)**

**CX-41□** Sensor

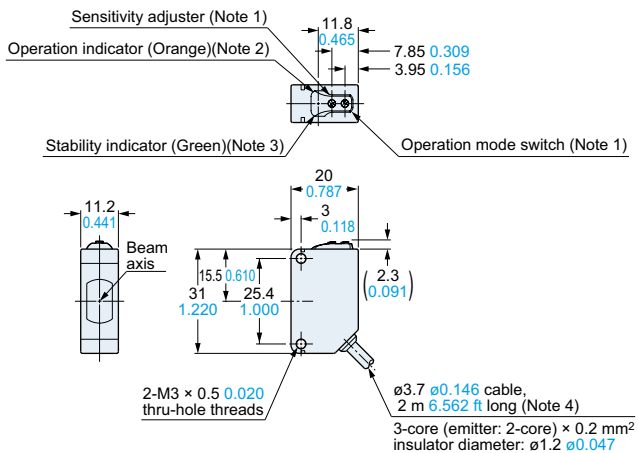

- Notes: 1) Not incorporated on the emitter and the basic type sensor.
- 2) It is the power indicator (green) on the emitter.
- 3) Not incorporated on the emitter.
- 4) Basic type: 0.5 m 1.640 ft long

**CX-41□-Z** Sensor

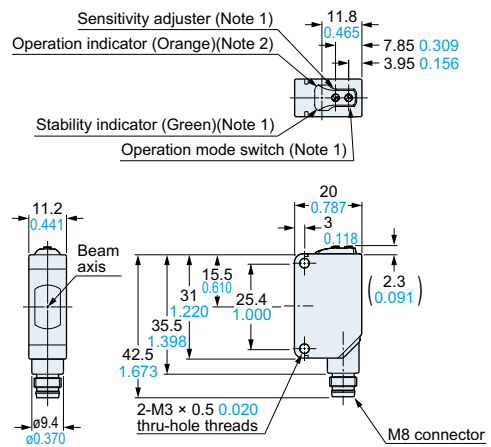

- Notes: 1) Not incorporated on the emitter.
- 2) It is the power indicator (green) on the emitter.

**CX-41□-J** Sensor

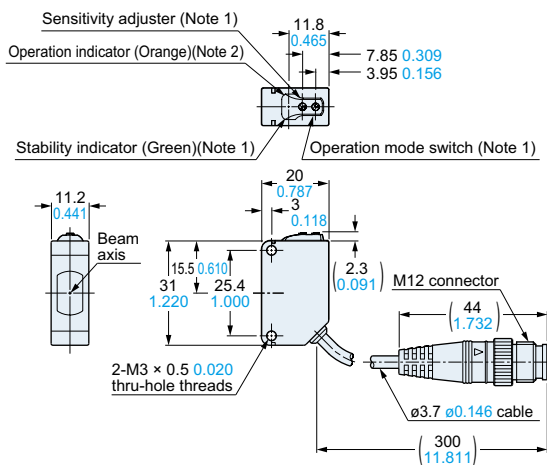

- Notes: 1) Not incorporated on the emitter.
- 2) It is the power indicator (green) on the emitter.

**CX-49□ CX-48□ CX-42□** Sensor

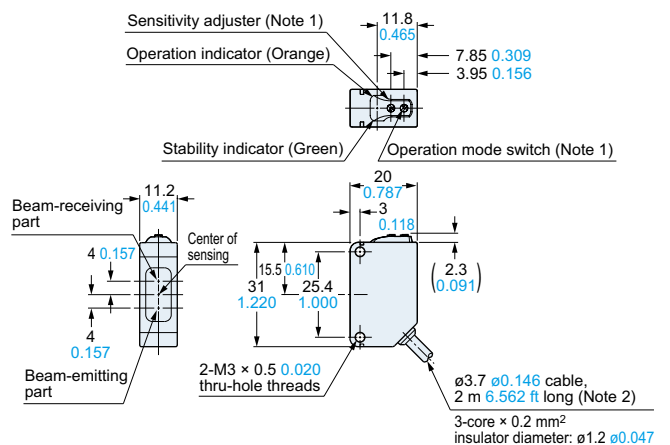

- Notes: 1) Not incorporated on the Basic type sensors.
- 2) Basic type: 0.5 m 1.640 ft long

**CX-49□-Z CX-48□-Z CX-42□-Z** Sensor

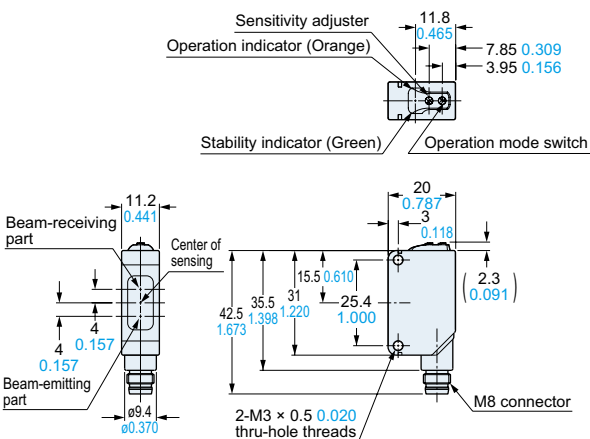

**CX-49□-J CX-48□-J CX-42□-J** Sensor

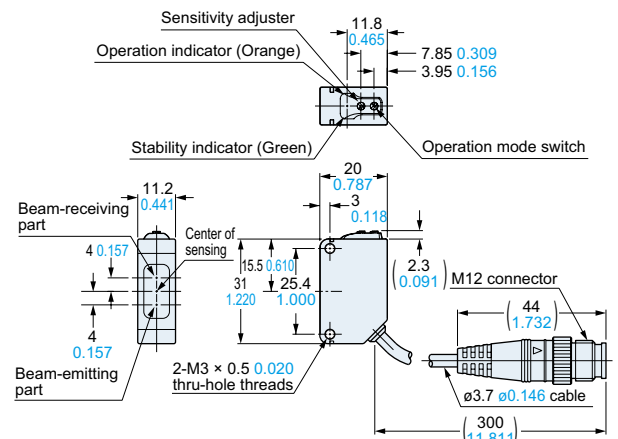

**DIMENSIONS (Unit: mm in)**

**CX-44□**

**Sensor**

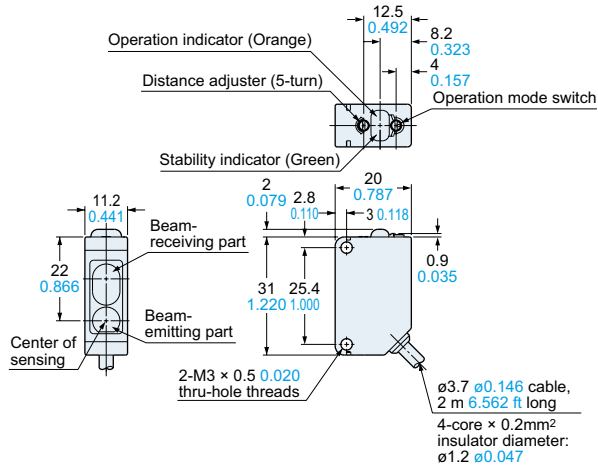

**CX-44□-Z**

**Sensor**

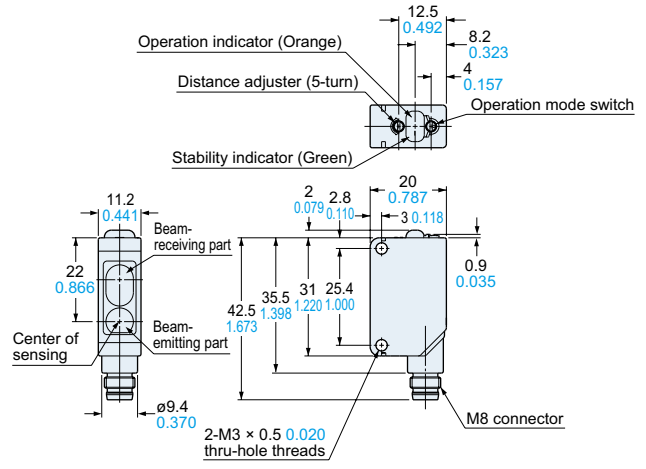

**RF-230** Reflector (Accessory for the retroreflective type sensor)

**RF-220** Reflector (Optional)

**RF-210** Reflector (Optional)

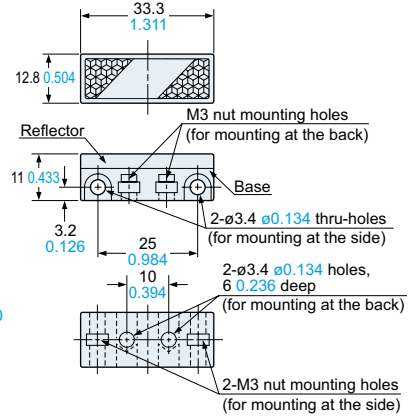
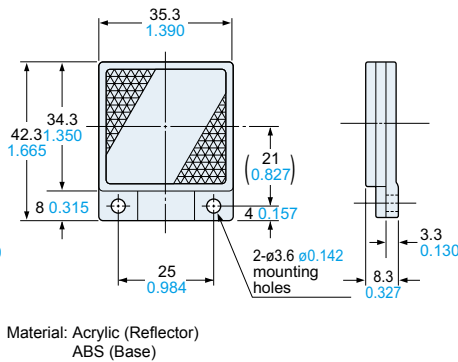
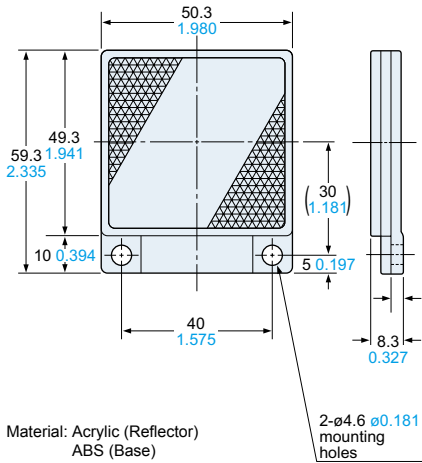

Note: It is not attached with the basic type sensor.

**RF-11** Reflective tape (Optional)

**RF-12** Reflective tape (Optional)

**RF-13** Reflective tape (Optional)

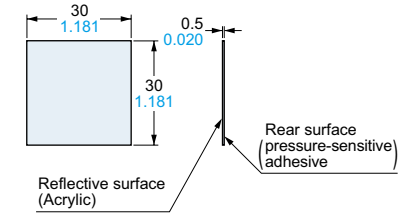
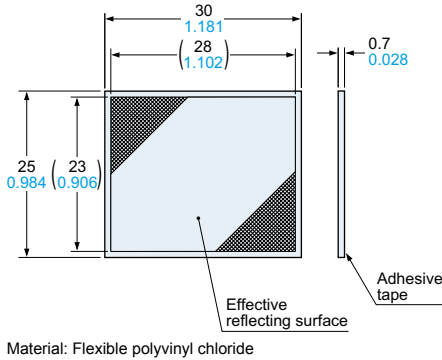
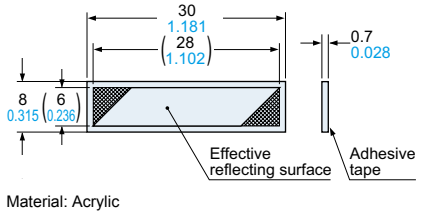

**DIMENSIONS (Unit: mm in)**

**MS-CX2-1**

Sensor mounting bracket (Optional)

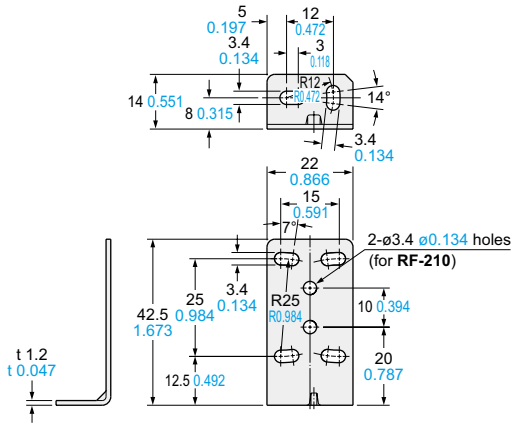

Material: Stainless steel (SUS304)  
Two M3 (length 12 mm 0.472 in) screws with washers are attached.

**Assembly dimensions**

Mounting drawing with the receiver of CX-41□

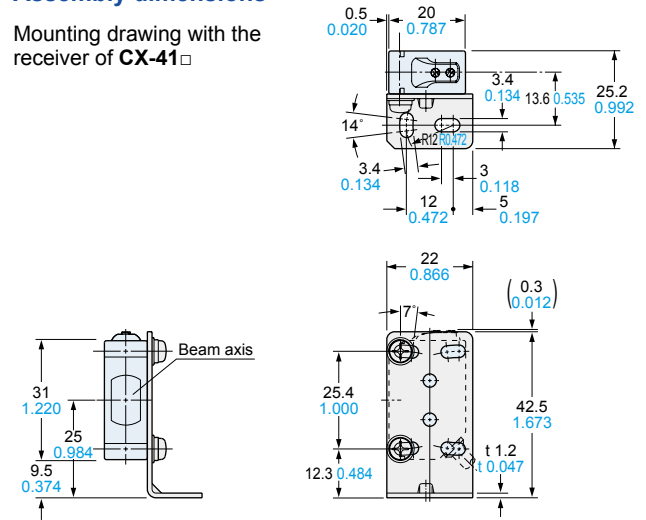

**MS-CX2-2**

Sensor mounting bracket (Optional)

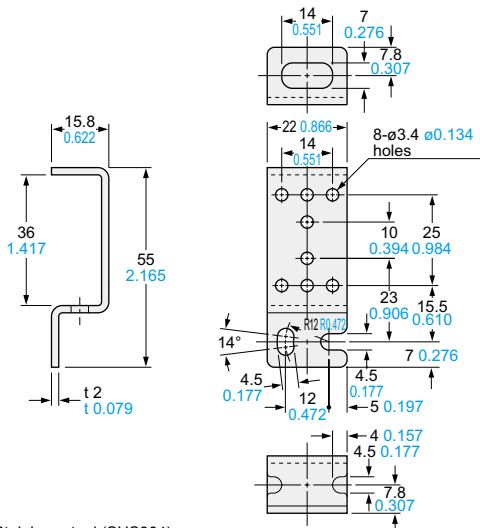

Material: Stainless steel (SUS304)  
Two M3 (length 12 mm 0.472 in) screws with washers are attached.

**Assembly dimensions**

Mounting drawing with the receiver of CX-41□

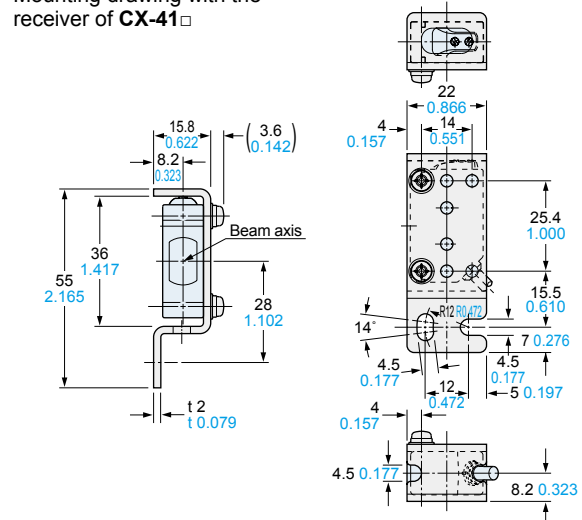

**MS-CX2-4**

Sensor mounting bracket (Optional)

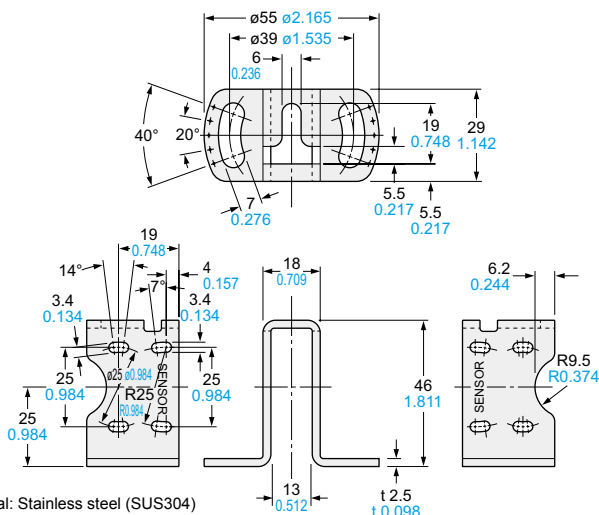

Material: Stainless steel (SUS304)  
Two M3 (length 14 mm 0.551 in) screws with washers are attached.

**Assembly dimensions**

Mounting drawing with the receiver of CX-41□

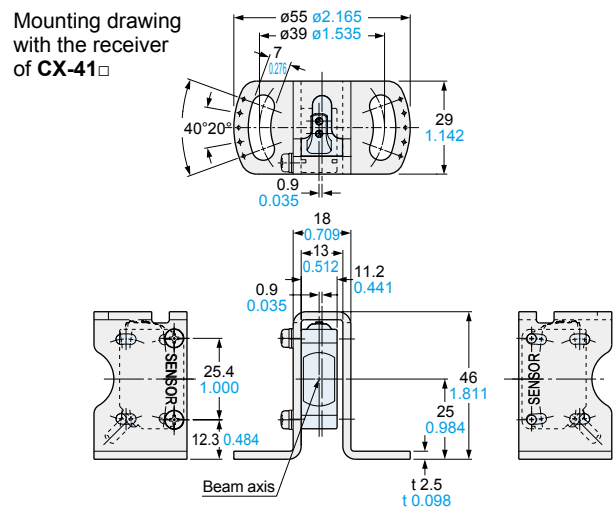

**DIMENSIONS (Unit: mm in)**

**MS-CX2-5**

Sensor mounting bracket (Optional)

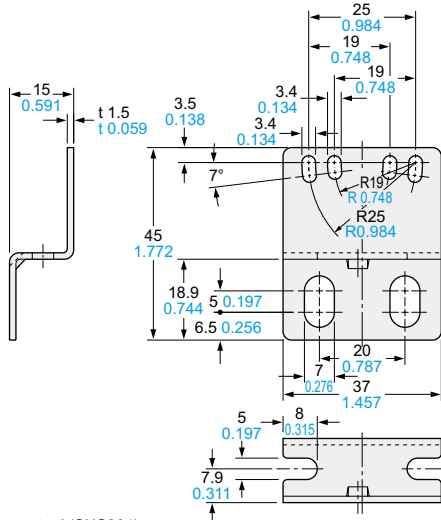

Material: Stainless steel (SUS304)

Two M3 (length 12 mm 0.472 in) screws with washers are attached.

**Assembly dimensions**

Mounting drawing with the receiver of CX-41□

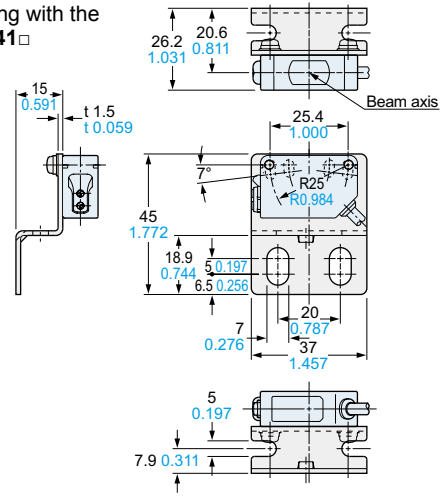

**MS-CX-3**

Sensor mounting bracket (Optional)

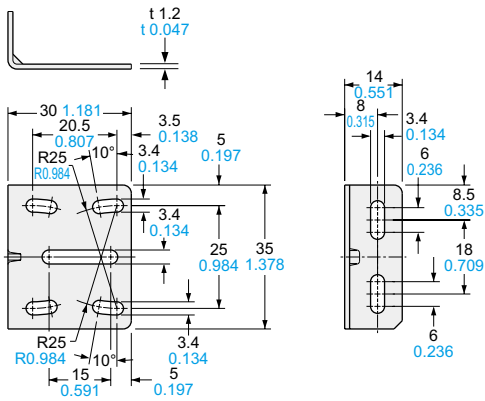

Material: Stainless steel (SUS304)

Two M3 (length 12 mm 0.472 in) screws with washers are attached.

**Assembly dimensions**

Mounting drawing with the receiver of CX-41□

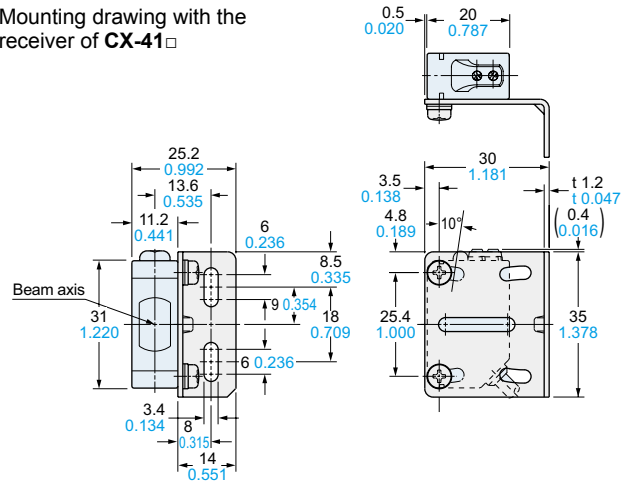

**DIMENSIONS (Unit: mm in)**

**MS-RF21-1**

Reflector mounting bracket for RF-210 (Optional)

**Assembly dimensions**

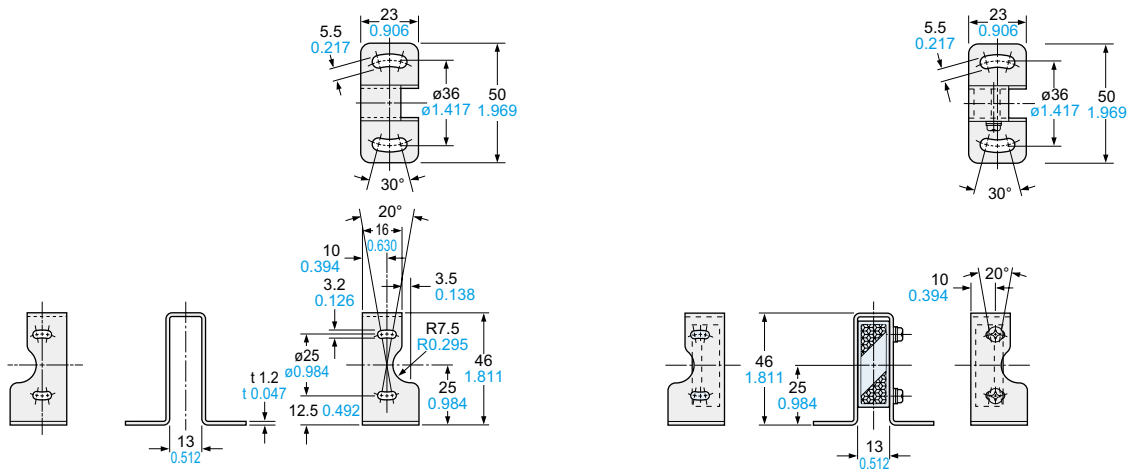

Material: Stainless steel (SUS304)  
Two M3 (length 12 mm 0.472 in) screws with washers are attached.

**MS-RF22**

Reflector mounting bracket for RF-220 (Optional)

**Assembly dimensions**

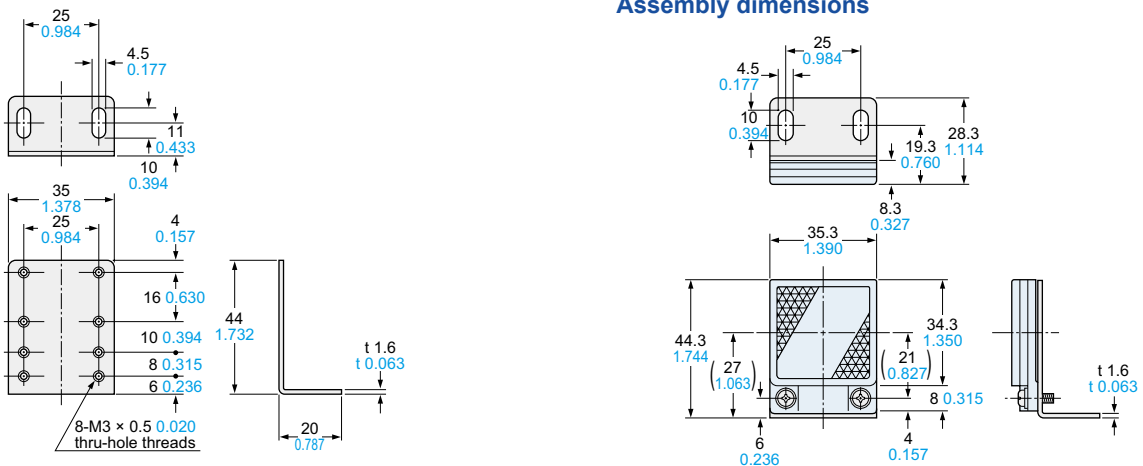

Material: Cold rolled carbon steel (SPCC)  
(Uni-chrome plated)  
Two M3 (length 8 mm 0.315 in) screws with washers are attached.

**MS-RF23**

Reflector mounting bracket for RF-230 (Optional)

**Assembly dimensions**

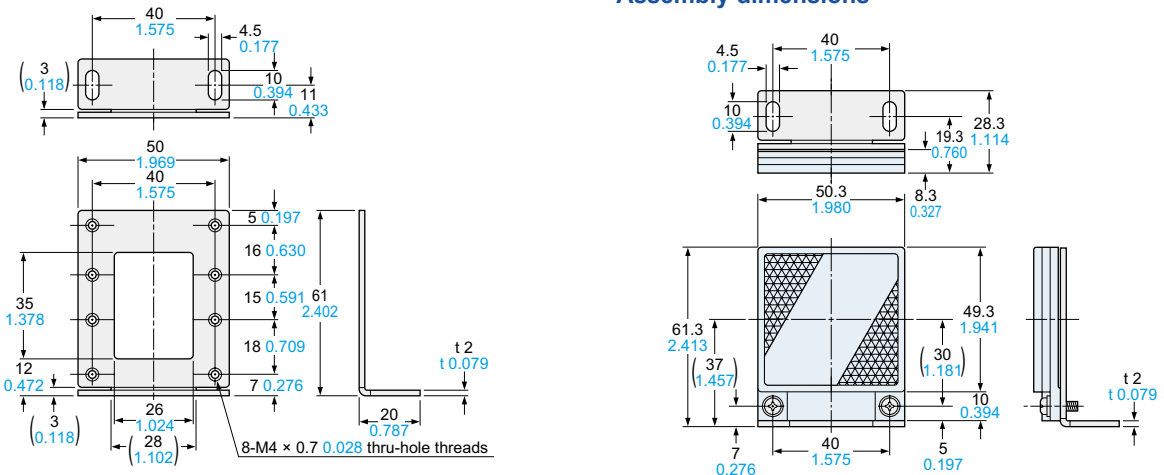

Material: Cold rolled carbon steel (SPCC)  
(Uni-chrome plated)  
Two M4 (length 10 mm 0.394 in) screws with washers are attached.

## Disclaimer

The applications described in the catalog are all intended for examples only. The purchase of our products described in the catalog shall not be regarded as granting of a license to use our products in the described applications. We do NOT warrant that we have obtained some intellectual properties, such as patent rights, with respect to such applications, or that the described applications may not infringe any intellectual property rights, such as patent rights, of a third party.

**Panasonic**  
INDUSTRY

**Panasonic Industry Co., Ltd.**

Industrial Device Business Division

7-1-1, Morofuku, Daito-shi, Osaka 574-0044, Japan

[industrial.panasonic.com/ac/e/](http://industrial.panasonic.com/ac/e/)