

IRAUDAMP19

100W/4Ω x 2 Channel Class D Audio Power Amplifier Using the IR4301

By
Jun Honda, Liwei Zheng



CAUTION:

International Rectifier suggests the following guidelines for safe operation and handling of IRAUDAMP19 Demo board;

- Always wear safety glasses whenever operating Demo Board
- Avoid physical contact with exposed metal surfaces when operating Demo Board
- Turn off Demo Board when placing or removing measurement probes

TABLE OF CONTENTS	PAGE
INTRODUCTION.....	3
SPECIFICATIONS	3
CONNECTION SETUP	4
TEST PROCEDURES.....	5
PERFORMANCE AND TEST GRAPHS	5
THERMAL INFORMATION	8
SCHEMATIC	9
BILL OF MATERIALS	10
PCB SPECIFICATIONS	12
REVISION CHANGES DESCRIPTIONS	14

Introduction

The IRAUDAMP19 reference design is a two-channel, 100W/ch (4 Ω/52V Bus voltage) half-bridge Class D audio power amplifier with single power supply. This reference design demonstrates how to use the IR4301 IC with single power supply, implement protection circuits, and design an optimum PCB layout using PowlRaudio integrated Class D IC. This reference design does not require additional heatsink or fan cooling for normal operation (one-eighth of continuous rated power). The reference design provides all the required housekeeping power supplies for ease of use. The two-channel design is scalable for power and the number of channels.

Applications

- AV receivers
- Home theater systems
- Mini component stereos
- Powered speakers
- Sub-woofers
- Musical Instrument amplifiers
- Car audio amplifiers

Features

Output Power:	100W x 2 channels (10%THD+N 4Ω load; no heatsink)
Multiple Protection Features:	Over-current protection (OCP), high side and low side Over-voltage protection (OVP), Under-voltage protection (UVP), high side and low side Over-temperature protection (OTP)
PWM Modulator:	Self-oscillating half-bridge topology

Specifications

General Test Conditions (unless otherwise noted)	Notes / Conditions	
Supply Voltages	41V~52V	Without heatsink
Load Impedance	2-4Ω	Resistive load
Self-Oscillating Frequency	400kHz	No input signal, Adjustable
Gain Setting	24.8dB	1Vrms input yields rated power

Electrical Data	Typical	Notes / Conditions
IR Devices Used	IR4301 PowlRaudio integrated Class D IC	
Modulator	Self-oscillating, second order sigma-delta modulation, analog input	
Power Supply Range	41V~52V*	Single power supply;
Output Power CH1-2: (1% THD+N)	82.5W	1kHz
Output Power CH1-2: (10% THD+N)	100W	1kHz
Rated Load Impedance	2-4Ω	Resistive load
Idling Supply Current	67mA	No input signal
Total Idle Power Consumption	3.5W	No input signal
Distortion	0.02%	THD+N @ 10W, 4Ω
Residual Noise	250μV	IHF-A weighted, AES-17 filter
Efficiency	90%	Single-channel driven, 100W, Class D stage

*Can be powered by 30V-41V supply with modifications of power resistors and UVP zener.(Please refer Page4)

Connection Setup

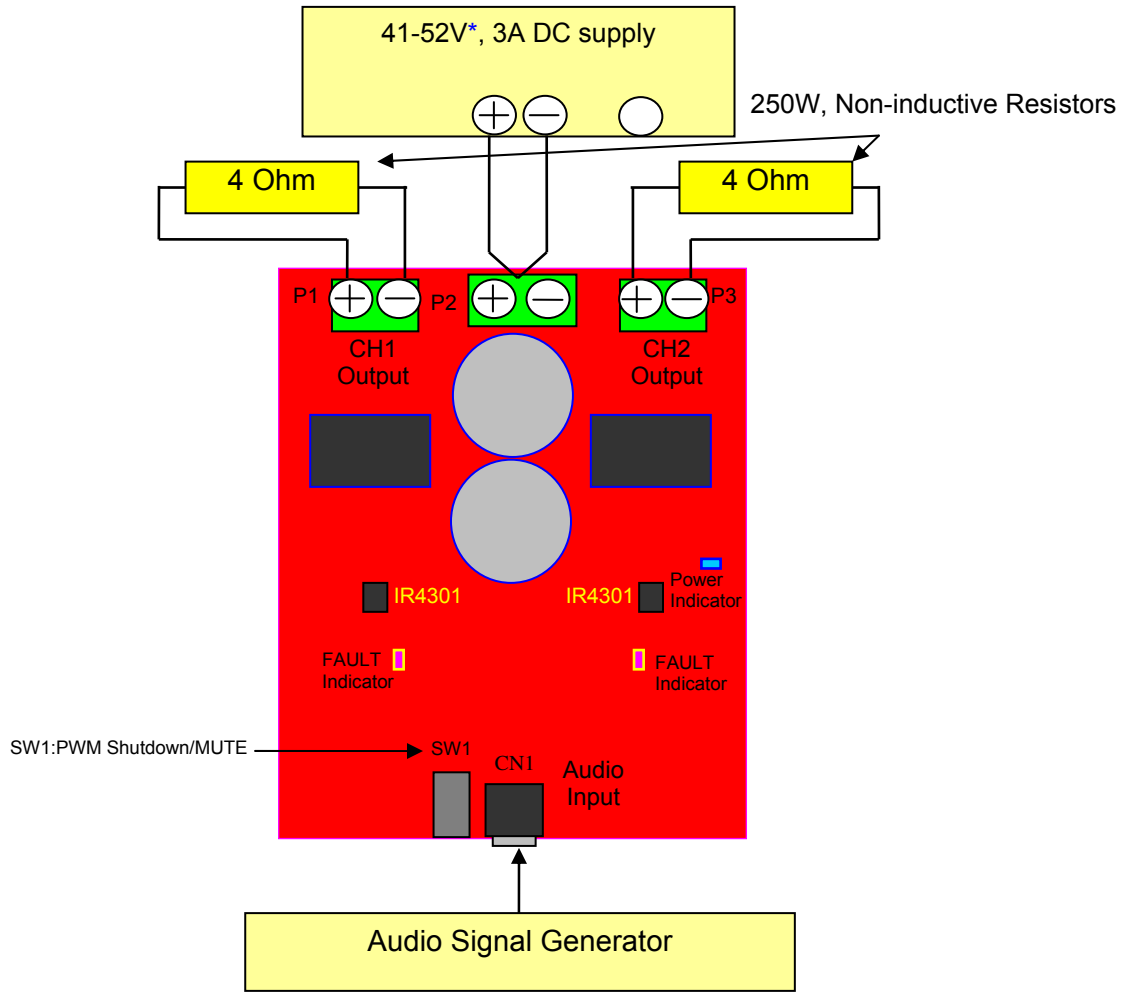

Fig 1 Typical Test Setup

Connector Description

Audio IN	CN1	Analog input for CH1 and CH2
POWER	P2	Single supply
CH1 OUT	P1	Output for CH1
CH2 OUT	P3	Output for CH2

*IRAUDAMP19 can be powered by 30V-41V supply with modifications of power resistors and UVP zener as below.

Power supply voltage	41-52V	30-41V
R25~R28,R56,R57,R64,R65	560 ohm	390 ohm
Z5	36V	27V

Test Procedures

Test Setup:

1. Connect 4Ω, 250W load to both output connectors, P1 and P3 and audio analyzer (Ap).
2. Connect Audio Signal Generator to CN1 for CH1 and CH2 respectively (Ap).
3. Connect a single power supply to P2 pre-adjusted to 30-52V as shown on Figure above
4. Turn on the power supply.
5. Turn on SW1 (right side).
6. Blue LED (Normal) stays turning on after RED LED extinguished.
7. With an Oscilloscope, monitor switching waveform at VS of CH1 and CH2.
8. Quiescent current for the power supply should be 55mA ±10mA at 52V.

Functionality Audio Tests:

9. Sweep the audio signal voltage from 15 mV_{RMS} to 1.5 V_{RMS}.
10. Monitor the output signals at P1/P3 with an oscilloscope. The waveform must be a non distorted sinusoidal signal with input sinusoidal signal below 1Vrms.

Performance and Test Graphs

Power vs THD+N (without heatsink)

Test Conditions:

VBus = 52V
Input Signal=1 kHz
Load Impedance = 4 ohms

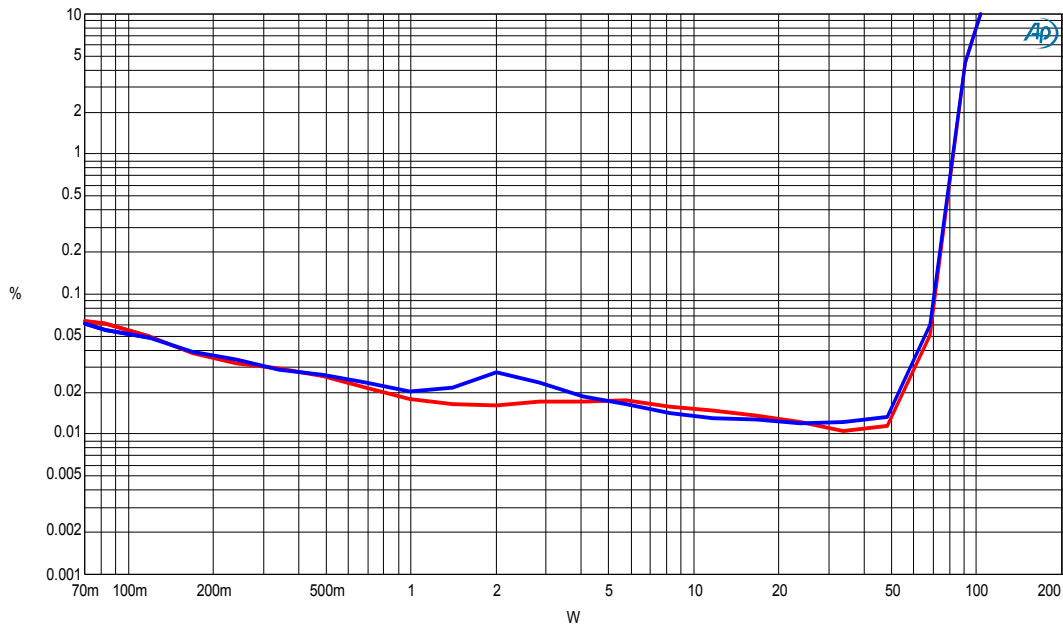

Sweep	Trace	Color	Line Style	Thick	Data	Axis	Comment
1	1	Red	Solid	3	Anlr.THd+N Ratio	Left	
1	3	Blue	Solid	3	Anlr.THd+N Ratio	Left	

Amp19.at27

Fig 2

Frequency Response

Test Conditions:

VBus = 52V
Set Output = 1W
Load Impedance = 4 ohms

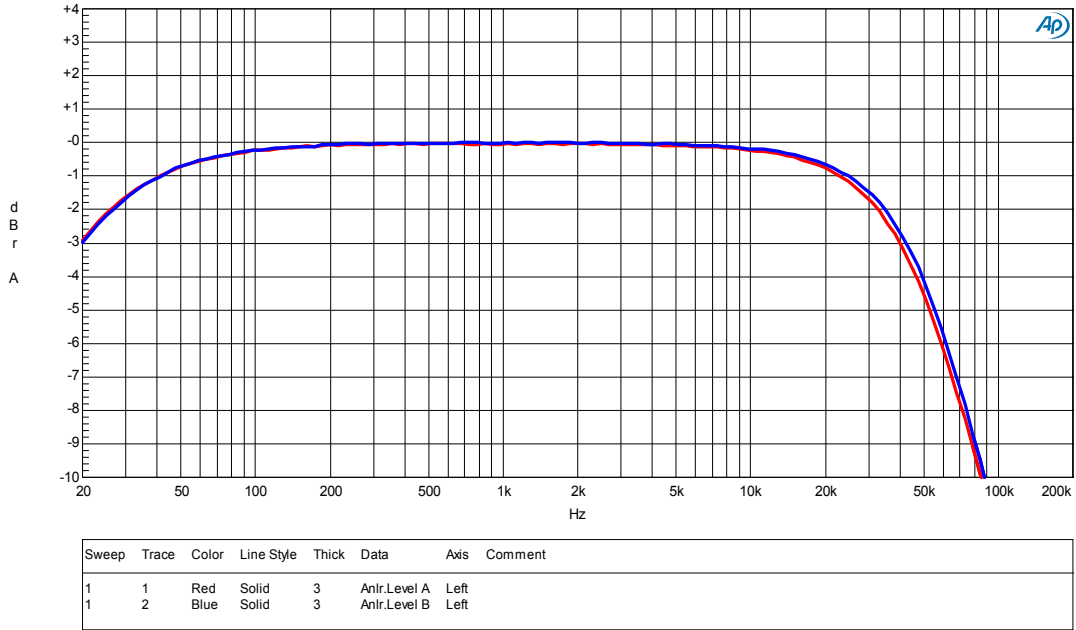

Fig 3

Noise Floor

Test Conditions:

VBus = 52V
Load Impedance = 4 ohms
No Input Signal

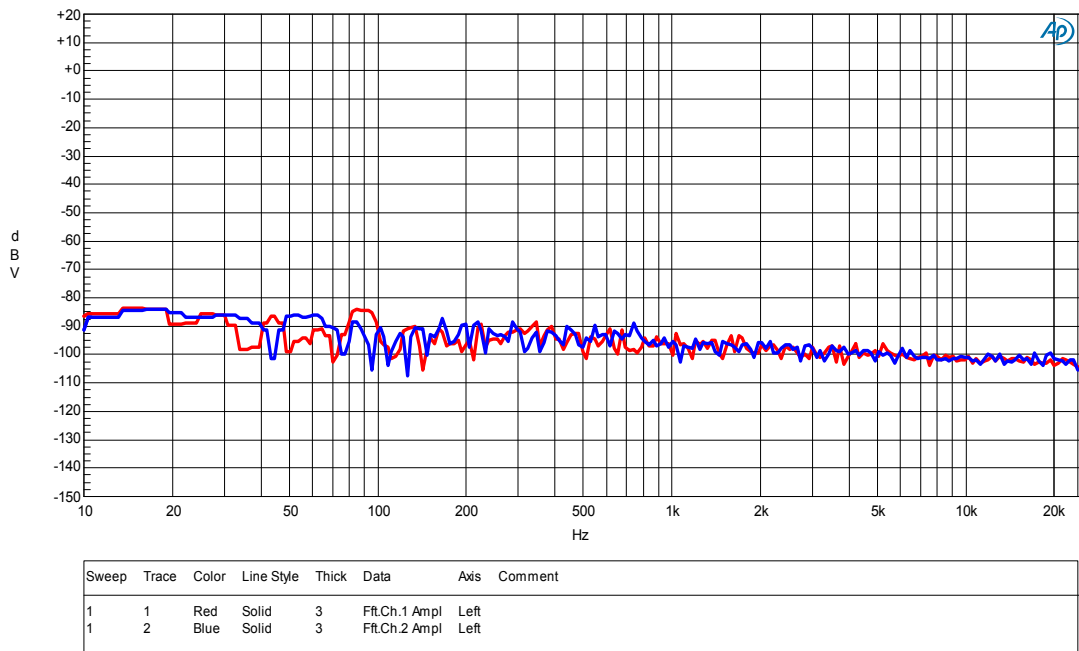

Fig 4

Noise Floor with 1Vrms Output

Test Conditions:

VBus = 52V

Output = 1Vrms @ 1 KHz

Load Impedance = 4 ohms

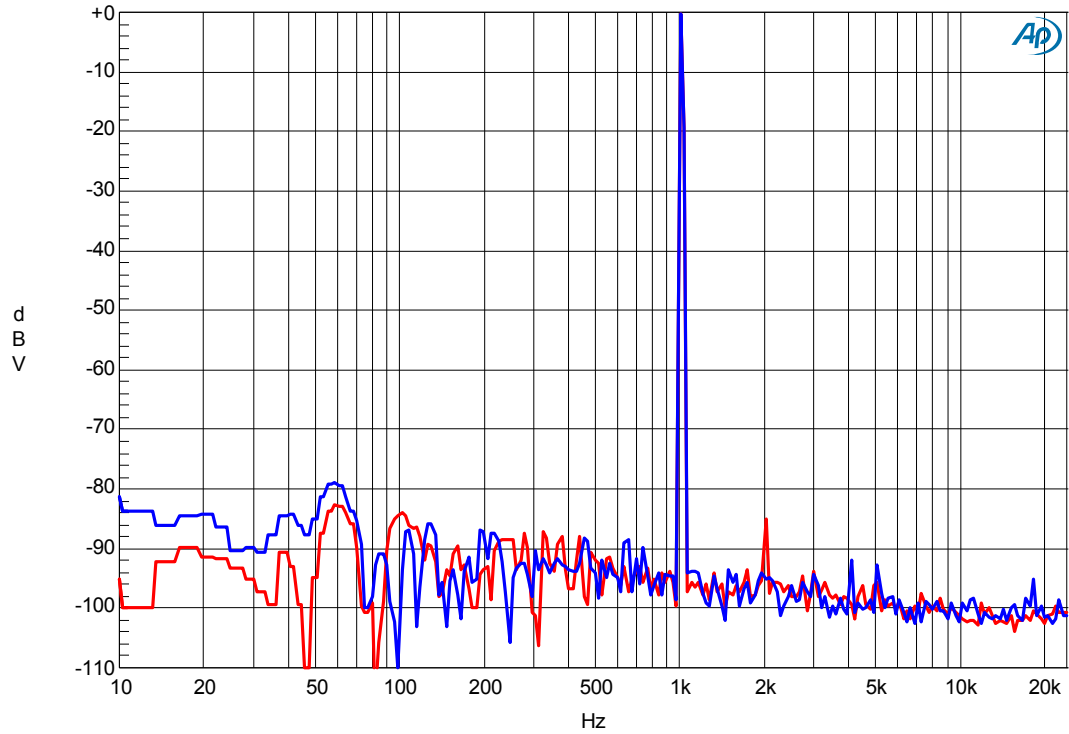

Fig 5

Thermal Information:

1/8 Po Thermal Test

Conditions:

- Tamb=25°C natural convection cooling
- Both Channel Driven 1/8Po continuous 30mins
- Temperature measured by infrared camera

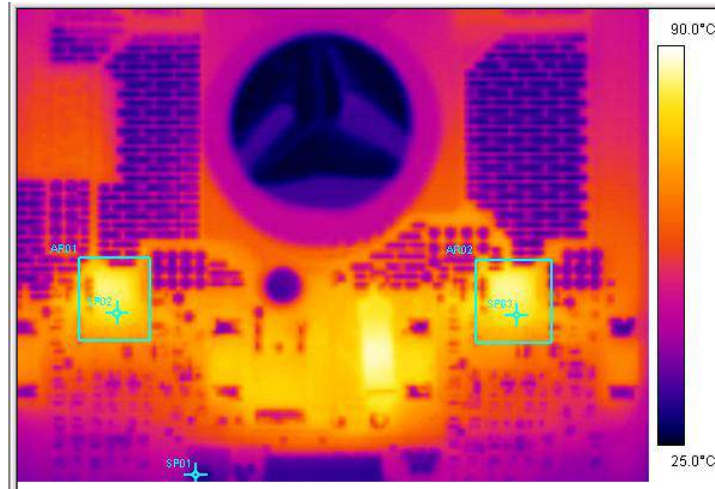

Fig 6 IRAUDAMP19 (Vbus=52V)

IR4301's temperature saturated around 80°C within 30minutes

Schematic

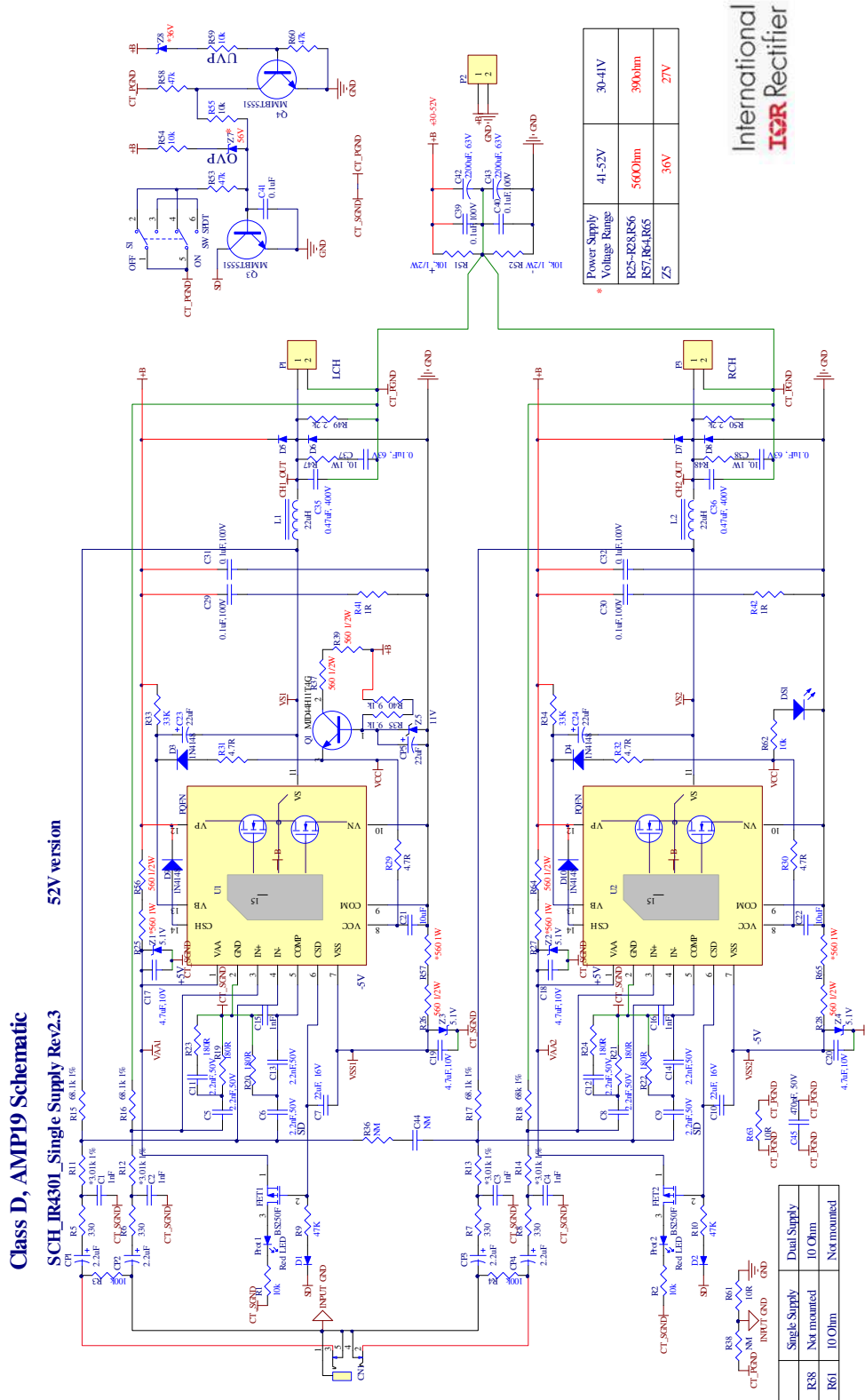

Fig7

Bill of Materials

No	Part Number	Designator	Description	Quantity	Vendor
1	490-1494-1-ND	C1, C2, C3, C4, C15, C16	CAP CER 1000PF 50V 10% X7R 0603	6	Digikey
2	445-1309-1-ND	C5, C6, C8, C9, C11, C12, C13, C14	CAP CER 2200PF 50V X7R 10% 0603	8	Digikey
3	587-1433-1-ND	C7, C10	CAP CER 22UF 16V X5R 1206	2	Digikey
4	478-1429-1-ND	C17, C18, C19, C20	CAP CER 4.7UF 10V Y5V 0805	4	Digikey
5	399-3525-1-ND	C21, C22	CAP CERAMIC 10UF 16V X7R 1206	2	Digikey
6	445-6797-1-ND	C23, C24	CAP CER 22UF 16V 10% X5R 0805	2	Digikey
7	445-1418-1-ND	C29, C30	CAP CER .10UF 100V X7R 10% 0805	2	Digikey
8	445-1377-1-ND	C31, C32, C39, C40	CAP CER 0.1UF 100V 10% X7R 1206	4	Digikey
9	495-1315-ND	C35, C36	CAP FILM 0.47UF 400VDC RADIAL	2	Digikey
10	BC2054-ND	C37, C38	CAP FILM MKP .1UF 63VDC 2%	2	Digikey
11	311-1140-1-ND	C41	CAP .10UF 50V CERAMIC X7R 0805	1	Digikey
12	565-1137-ND	C42, C43	CAP ALUM 2200UF 63V 20% RADIAL	2	Digikey
13	311-1124-1-ND	C45	CAP 470PF 50V CERAMIC X7R 0805	1	Digikey
14	CP1-3545N-ND	CN1	CONN JACK STEREO R/A 5PIN 3.5MM	1	Digikey
15	565-1103-ND	CP1, CP2, CP3, CP4	CAP ALUM 2.2UF 50V 20% RADIAL	4	Digikey
16	565-1056-ND	CP5	CAP 22UF 25V ELECT VR RADIAL	1	Digikey
17	1N4148WS-FDICT-ND	D1, D2	DIODE SWITCH 75V 200MW SOD323	2	Digikey
18	1N4148WDICT-ND	D3, D4, D9, D10	DIODE SWITCH 100V 400MW SOD-123	4	Digikey
19	S1DFSCT-ND	D5, D6, D7, D8	DIODE GP 200V 1A DO214AC	4	Digikey
20	160-1647-1-ND	DS1	LED BLUE CLEAR THIN 0603 SMD	1	Digikey
21	BS250FCT-ND	FET1, FET2	MOSFET P-CH 45V 90MA SOT23-3	2	Digikey
22	7G14A-220M-B	L1, L2	Class D Inductor, 22UH	2	Inductors, Inc
23	281-1414-ND	P1, P3	CONN TERM BLOCK PCB 5.0MM 2POS	2	Digikey
24	281-1414-ND	P2	CONN TERM BLOCK PCB 5.0MM 2POS	1	Digikey
25	160-1182-1-ND	Prot1, Prot2	LED RED ORANGE CLEAR 0603 SMD	2	Digikey
26	MJD44H11T4GOSCT-ND	Q1	TRANS PWR NPN 8A 80V DPAK	1	Digikey
27	MMBT5551FSCT-ND	Q3, Q4	TRANSISTOR NPN 160V SOT-23	2	Digikey
28	311-10KGRCT-ND	R1, R2, R62	RES 10K OHM 1/10W 5% 0603 SMD	3	Digikey
29	RMCF0603JT100KCT-ND	R3, R4	RES 100K OHM 1/10W 5% 0603 SMD	2	Digikey
30	RMCF0603JT330RCT-ND	R5, R6, R7, R8	RES 330 OHM 1/10W 5% 0603 SMD	4	Digikey
31	RHM47KGCT-ND	R9, R10	RES 47K OHM 1/10W 5% 0603 SMD	2	Digikey
32	RHM3.01KCRCT-ND	R11, R12, R13, R14	RES 3.01K OHM 1/8W 1% 0805 SMD	4	Digikey
33	RMCF0805FT68K1CT-ND	R15, R16, R17, R18	RES 68.1K OHM 1/8W 1% 0805 SMD	4	Digikey

34	RHM180GCT-ND	R19, R20, R21, R22, R23, R24	RES 180 OHM 1/10W 5% 0603 SMD	6	Digikey
35	RHM560BCCT-ND	R25, R27, R57, R65	RES 560 OHM 1W 5% 2512 SMD	4	Digikey
36	560H-ND	R26, R28, R37, R39, R56, R64	RES 560 OHM 1/2W 5% AXIAL	6	Digikey
37	P4.7ACT-ND	R29, R30, R31, R32	RESISTOR 4.7 OHM 1/8W 5% 0805	4	Digikey
38	RHM33KGCT-ND	R33, R34	RES 33K OHM 1/10W 5% 0603 SMD	2	Digikey
39	RHM9.1KARCT-ND	R35, R40	RES 9.1K OHM 1/8W 5% 0805 SMD	2	Digikey
40	1.1KW-1-ND	R37	RES 1.1K OHM 1W 5% METAL OXIDE	2	Digikey
41	923345-06-ND	JW1	JUMPER WIRE 0.6" LONG PKG OF 150	1	Digikey
42	P1.0ACT-ND	R41, R42	RESISTOR 1.0 OHM 1/8W 5% 0805	2	Digikey
43	541-10.0AFCT-ND	R47, R48	RES 10.0 OHM 1W 1% 2512 SMD	2	Digikey
44	RMCF0805JT2K20CT-ND	R49, R50	RES 2.2K OHM 1/8W 5% 0805 SMD	2	Digikey
45	541-10KVCT-ND	R51, R52	RES 10K OHM 1/2W 5% 1210 SMD	2	Digikey
46	RHM47KARCT-ND	R53, R58, R60	RES 47K OHM 1/8W 5% 0805 SMD	3	Digikey
47	RHM10KARCT-ND	R54, R55, R59	RES 10K OHM 1/8W 5% 0805 SMD	3	Digikey
48	311-10ARCT-ND	R61	RES 10 OHM 1/8W 5% 0805 SMD	1	Digikey
49	311-10ARCT-ND	R63	RES 10 OHM 1/8W 5% 0805 SMD	1	Digikey
50	360-1758-ND	S1	SWITCH TOGGLE SPDT .4VA SEAL PCB	1	Digikey
51	IR4301M	U1, U2	1 CH PowIRaudio integrated Class D IC	2	IR
52	DDZ5V1BDICT-ND	Z1, Z2, Z3, Z4	DIODE ZENER 5.1V 500MW SOD-123	4	Digikey
53	BZT52C11-FDICT-ND	Z5	DIODE ZENER 11V 500MW SOD123	1	Digikey
54	MMSZ5263BT1GOSCT-ND	Z7	DIODE ZENER 56V 500MW SOD123	1	Digikey
55	BZT52C36-FDICT-ND	Z8*	DIODE ZENER 36V 500MW SOD123	1	Digikey

*BOM is for 41V-52V power supply
IRAUDAMP19 can be powered by 30V-41V supply with modifications of power resistors and UVP zener as below.

Power supply voltage	41-52V	30-41V
R25~R28,R56,R57,R64,R65	560 ohm	390 ohm
Z5	36V	27V

PCB Specifications

PCB:

1. Two Layers SMT PCB with through holes
2. 1/16 thickness
3. 2/0 OZ Cu
4. FR4 material
5. 10 mil lines and spaces
6. Solder Mask to be Green enamel EMP110 DBG (CARAPACE) or Enthone Endplate DSR-3241 or equivalent.
7. Silk Screen to be white epoxy non conductive per IPC-RB 276 Standard.
8. All exposed copper must finished with TIN-LEAD Sn 60 or 63 for 100u inches thick.
9. Tolerance of PCB size shall be 0.010 -0.000 inches
10. Tolerance of all Holes is $-.000 + 0.003$ "
11. PCB acceptance criteria as defined for class II PCB'S standards.

PCB Layout
Top side:

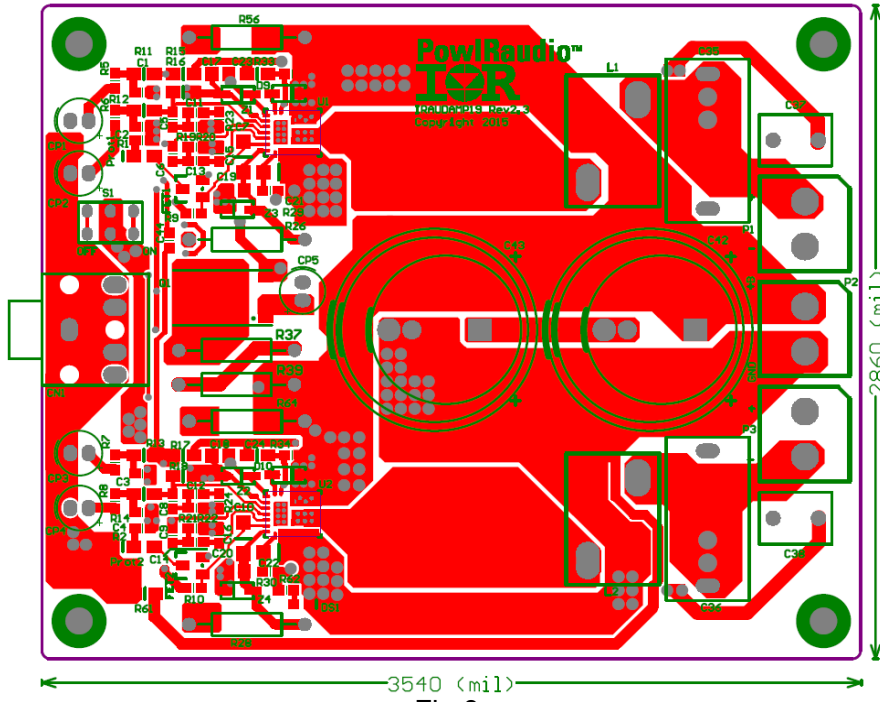

Fig 8

Bottom side:

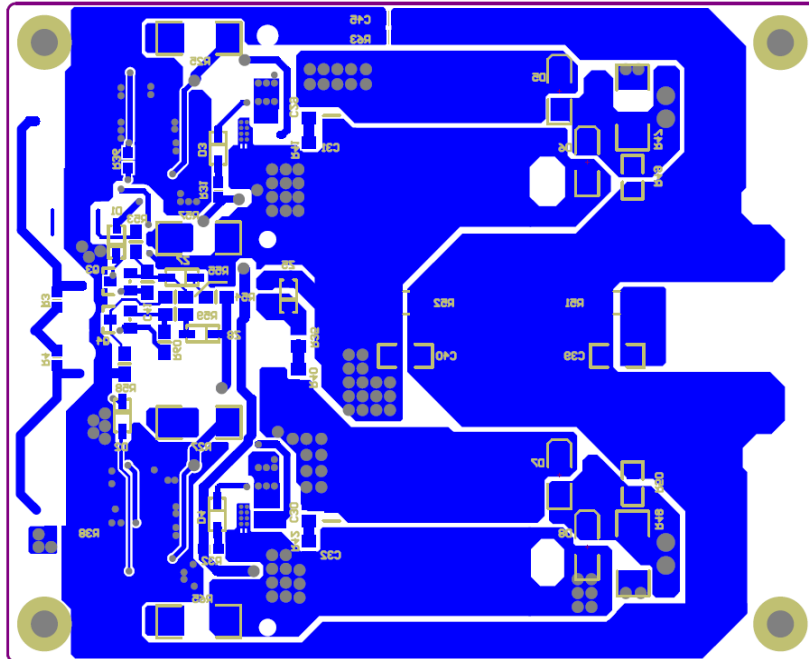

Fig 9

Note: Refer to AN1170 for footprint and board mounting details.

Revision changes descriptions

Revision	Changes description	Date
Rev 1.0	Released	May, 16 2012
Rev 2.0	100W version	April, 26 2013
Rev 3.0	Housekeeping's power resistors have been changed from 1.2kohm to 560ohm	October,24 2014