

DIN-Rail terminal blocks with ratings up to **200 kA SCCR**

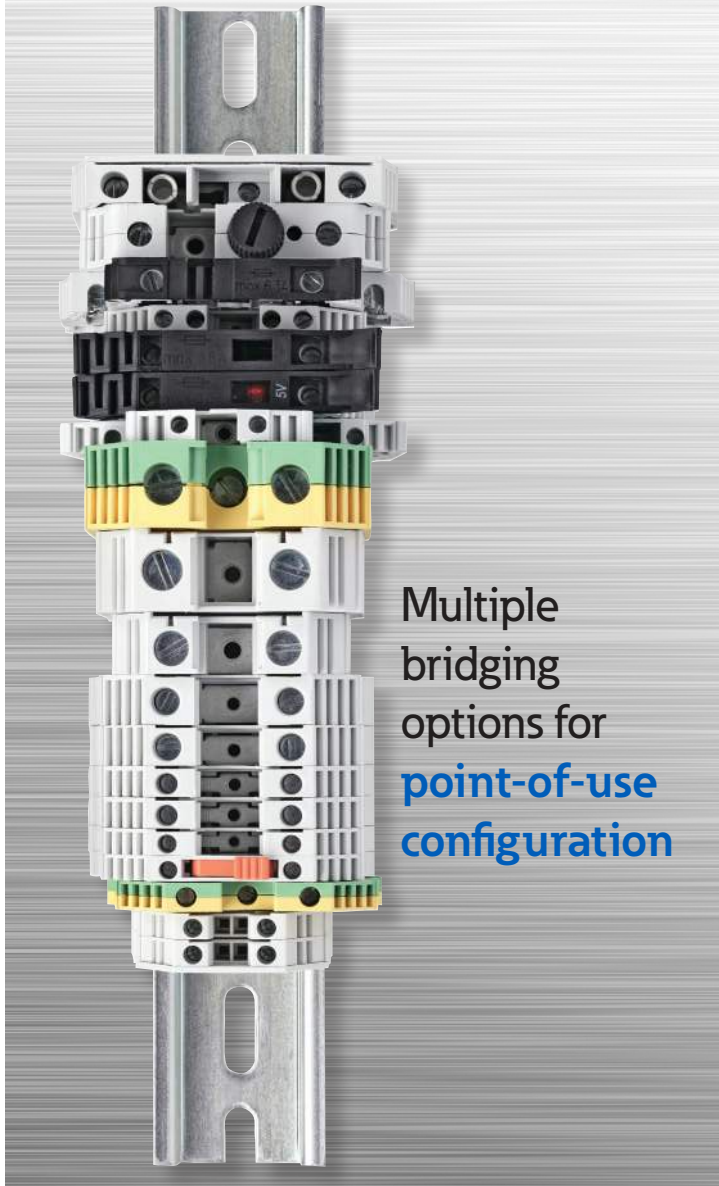

Multiple bridging options for **point-of-use configuration**

Contents

Description	Section page
Compact rail and panel mount blocks	
NDN DIN-Rail and C-Rail feed through blocks	2-3
N512, NFT2, NFT3, NC3, NSE3, NSS3 C-Rail feed through blocks	4-5
15188, PLU3, PLU1, PSU1 depluggable DIN-Rail and C-Rail blocks	6-7
KT3, KT4 multi-pole panel mount blocks	7
BNQ21, BQQ41 quick-connect panel mount blocks	8
Power feed through terminal blocks	
C7021 1- to 6-pole block	9
Double row terminal blocks	
TB100 2- to 36-pole blocks	10-11
TB200 and TB200HB 2- to 30-pole blocks	12-13
TB300 and TB345 2- to 24-pole blocks	14-15
Accessories for double row terminal blocks	
Marking options and covers	16
Top and bottom marking strips for terminal blocks	17
Double row terminal blocks continued	
TB400 2- to 12-pole blocks	18
KU 2- to 12-pole blocks	19
Accessories	
End brackets	20
DIN-Rail and C-Rail mounting rails and brackets	20

Connector products

NDN DIN-Rail feed through blocks

The NDN feed through blocks feature a compact line of terminal blocks suitable for both 35mm DIN-Rail or C-Rail applications. Products easily snap onto the mounting rail for a quick, simple, low-cost solution. Available accessories include jumpers and marking tape.

UL E62622

CSA File 15364

CSA File 47235 (NDN1, NDN111)

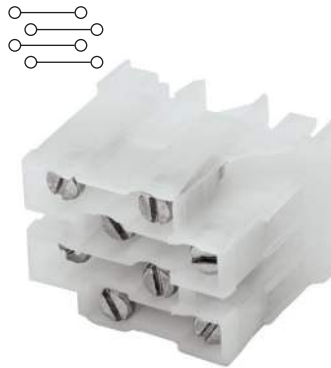

NDNV4

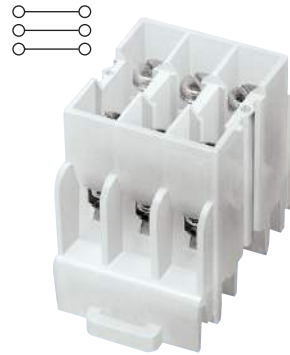

NDN3

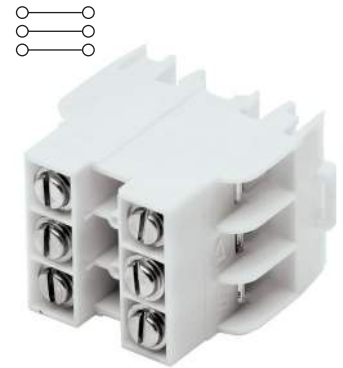

NDN63

Approval	
Technical data	
Rated voltage	600V
Rated Current	30A
Center spacing, in (mm)	0.25 / 6.35
Conductor cross-section, flexible (AWG/mm ²)	22-10 / 0.3-5.3
Number of Poles	4
Circuits per foot	48
Torque(N•m)	2
Torque(lb-in)	18
Screw	#6-32
WxHxD(mm)	25.4 x 34 x 42.4
Colors	Cat. no.
○ White (standard)	NDNV4-WH
● Black	NDNV4-BK
Accessories	Cat. no.
4 circuits	JN4
Marking tape	MTC6
35mm DIN-Rail	DRL35MML DRL35MMHI
C-Rail	NFTA NRA
Modular option	—

Approval	
Technical data	
Rated voltage	600V
Rated Current	30A
Center spacing, in (mm)	0.3 / 7.62
Conductor cross-section, flexible (AWG/mm ²)	22-10 / 0.3-5.3
Number of Poles	3
Circuits per foot	38
Torque(N•m)	2
Torque(lb-in)	18
Screw	#6-32
WxHxD(mm)	23.9 x 33.3 x 42.4
Colors	Cat. no.
○ White (standard)	NDN3-WH
● Blue	NDN3-BL
Accessories	Cat. no.
2 circuits	JNDN3
Marking tape	MT12-1-2
35mm DIN-Rail	DRL35MML DRL35MMHI
C-Rail	NFTA NRA
Modular option	—

Approval	
Technical data	
Rated voltage	600V
Rated Current	65A
Center spacing, in (mm)	0.375 / 9.52
Conductor cross-section, flexible (AWG/mm ²)	18-6 / 0.8-13.3
Number of Poles	3
Circuits per foot	30
Torque(N•m)	4
Torque(lb-in)	35
Screw	#10-32
WxHxD(mm)	29.7 x 36.8 x 42.4
Colors	Cat. no.
○ White (standard)	NDN63-WH
● Black	NDN63-BK
Accessories	Cat. no.
2 circuits	JN1
Marking tape	MT12-1-2
35mm DIN-Rail	DRL35MML DRL35MMHI
C-Rail	NFTA NRA
Modular option	—

Block
Jumper
Marking tape
Mounting
Modular option

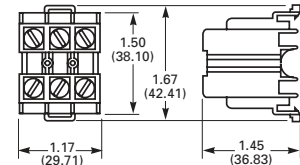
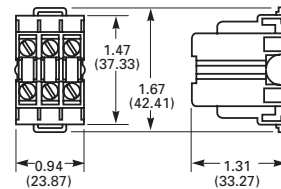
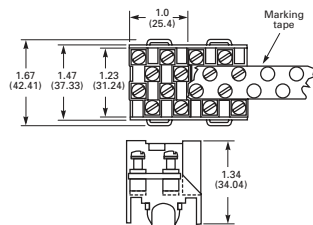



NDN1

Approval 

Technical data

Rated voltage	600V
Rated Current	90A
Center spacing in (mm)	0.635 / 16.31
Conductor cross-section, flexible (AWG/mm ²)	18-2 / 0.8-33.6
Number of Poles	1
Circuits per foot	18
Torque(N•m)	3.6
Torque(lb-in)	32
Screw	1/4-28
WxHxD(mm)	15 x 30.3 x 43.5

Colors Cat. no.

○ White (standard) NDN1-WH

Accessories Cat. no.

—	—
	MT12-1-2
35mm DIN-Rail	DRL35MML DRL35MMHI
C-Rail	NFTA NRA

Dimensions — in (mm)

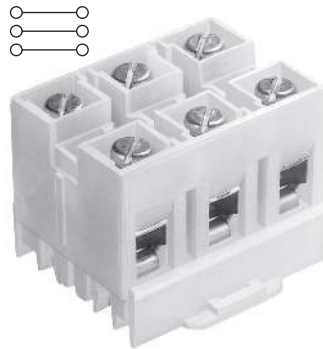
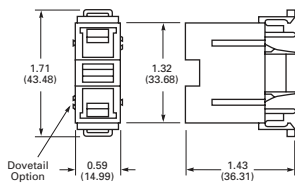

NDN111

Approval 

Technical data

Rated voltage	600V
Rated Current	90A
Center spacing in (mm)	0.635 / 16.31
Conductor cross-section, flexible (AWG/mm ²)	18-2 / 0.8-33.6
Number of Poles	3
Circuits per foot	18
Torque(N•m)	3.6
Torque(lb-in)	32
Screw	1/4-28
WxHxD(mm)	47.5 x 36.6 x 43.5

Colors Cat. no.

○ White (standard) NDN111-WH

● Black NDN111-BK

Accessories Cat. no.

2 circuits	JN1
	MT12-1-2
35mm DIN-Rail	DRL35MML DRL35MMHI
C-Rail	NFTA NRA

NDN111A-WH, NDN111A-BK

Dimensions — in (mm)

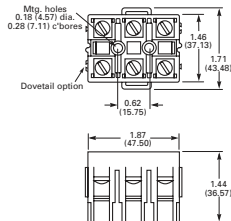

C-Rail feed through terminal blocks

C-Rail terminal blocks provide a low-profile, compact foot-print solution for various wire connection applications. Products feature an easy, snap-on installation method and an array of accessories including jumpers and marking strips.

UL E62622 (excluding N512)

CSA File 15364

CSA File 47235 (NFT3)

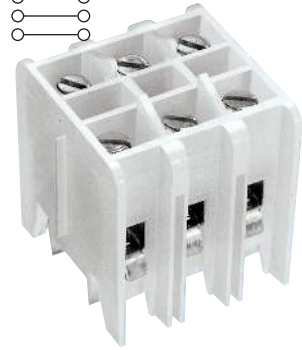
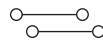
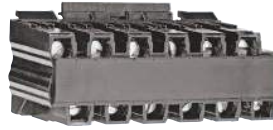

N512

NFT2

NFT3

Approval	
Technical data	
Rated voltage	300V 600V
Rated current	20A 5A
Center spacing in (mm)	0.197 / 5.0
Conductor cross-section, flexible (AWG/mm ²)	22-12 / 0.3-3.3
Number of Poles	12
Circuits per foot	60
Torque(N*m)	1.4
Torque(lb-in)	12
Screw	#4-48
WxHxD(mm)	61.0 x 27.7 x 22.4
Colors	Cat. no.
● Black (standard)	N512-BK
—	—
Accessories	Cat. no.
12 circuits	JN512
Marking tape	AT512
Mounting	C-Rail NFTA NRA
Dimensions — in (mm)	

Approval	
Technical data	
Rated voltage	600V
Rated Current	40A
Center spacing in (mm)	0.28 / 7.13
Conductor cross-section, flexible (AWG/mm ²)	22-8 / 0.3-8.4
Number of Poles	2
Circuits per foot	38
Torque(N*m)	2
Torque(lb-in)	18
Screw	#8-32
WxHxD(mm)	16.5 x 34.7 x 42.8
Colors	Cat. no.
○ White (standard)	NFT2-WH
—	—
Accessories	Cat. no.
2 circuits	JN2
Marking tape	MT12-1-2
Mounting	C-Rail NFTA NRA
Dimensions — in (mm)	

Approval	
Technical data	
Rated voltage	600V
Rated Current	40A
Center spacing in (mm)	0.39 / 9.91
Conductor cross-section, flexible (AWG/mm ²)	22-8 / 0.3-8.4
Number of Poles	3
Circuits per foot	28
Torque(N*m)	2
Torque(lb-in)	18
Screw	#8-32
WxHxD(mm)	30.0 x 32.9 x 31.4
Colors	Cat. no.
○ White (standard)	NFT3-WH
● Black	NFT3-BK
Accessories	Cat. no.
2 circuits	JN3
Marking tape	MT12-1-2
Mounting	C-Rail NFTA NRA
Dimensions — in (mm)	

- Block
- Jumper
- Marking tape
- Mounting

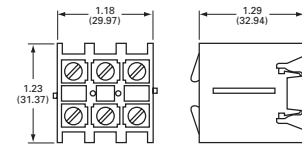
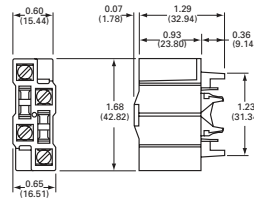
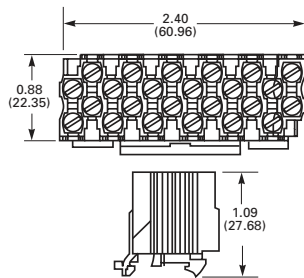



NC3

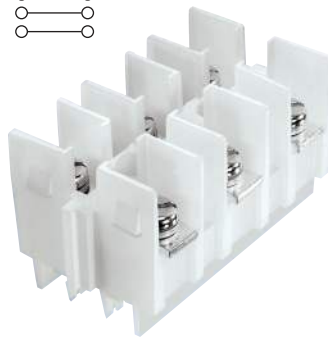

NSE3



3-pole



NSS3

Approval

Technical data

Rated voltage	600V
Rated Current	175A
Center spacing in (mm)	1.06 / 26.92
Conductor cross-section, flexible (AWG/mm ²)	14-2/0 / 2.1-67.4 Cu/AL
Number of Poles	3
Circuits per foot	11
Torque(N•m)	5.1
Torque(lb-in)	45
Screw	5/16 - 24
WxHxD(mm)	79.4 x 44.5 x 44.5

Colors **Cat. no.**

○ White (standard)	NC3-WH
--------------------	--------

Accessories **Cat. no.**

—	—
—	MT12-1-2

Panel mount	—
C-Rail	NFTA NRA

Dimensions — in (mm)

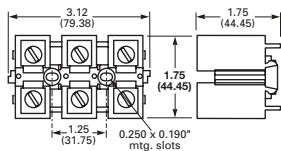

Approval

Technical data

Rated voltage	600V
Rated Current	115A
Center spacing in (mm)	1.06 / 26.92
Conductor cross-section, flexible (AWG/mm ²)	Ring terminals only
Number of Poles	3
Circuits per foot	11
Torque(N•m)	3.6
Torque(lb-in)	32
Screw	1/4 - 28
WxHxD(mm)	79.2 x 38.9 x 44.5

Colors **Cat. no.**

○ White (standard)	NSE3-WH
--------------------	---------

Accessories **Cat. no.**

2 circuits	JNSE3
—	MT12-1-2

Panel mount	—
C-Rail	NFTA Series NRA Series

Dimensions — in (mm)

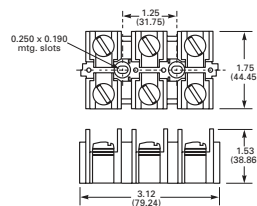

Approval

Technical data

Rated voltage	600V
Rated Current	30A
Center spacing in (mm)	0.385 / 9.77
Conductor cross-section, flexible (AWG/mm ²)	Ring terminals only
Number of Poles	3
Circuits per foot	28
Torque(N•m)	1.4
Torque(lb-in)	12
Screw	#6-32
WxHxD(mm)	31.5 x 33.7 x 31.8

Colors **Cat. no.**

○ White (standard)	NSS3-WH
--------------------	---------

Accessories **Cat. no.**

2 circuits	JNSS3
—	MT12-1-2

Panel mount	—
C-Rail	NFTA NRA

Dimensions — in (mm)

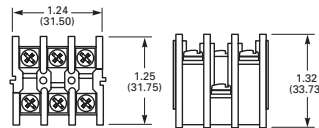

DIN-Rail depluggable blocks

Depluggable terminal blocks are available for both 35mm DIN-Rail and C-Rail applications. These blocks provide a simple depluggable* option for panel wiring applications with the convenience of quick, easy, snap-on installation. Product accessories, such as jumpers and marking tape, are available for most products.

UL E62622

CSA File 15364

CSA File 47235 (15188 Series)

* Not for use as a load break disconnect.



15188

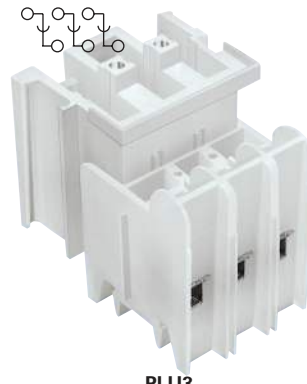

PLU3

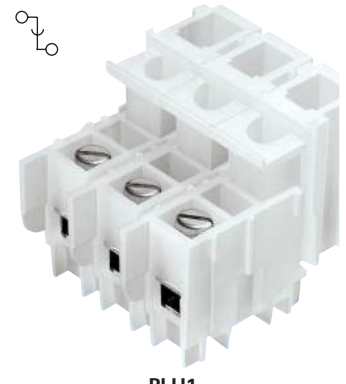

PLU1

Approval	
Technical data	
Rated voltage	600V
Rated Current	30A
Center spacing in (mm)	0.375 / 9.52
Conductor cross-section, flexible (AWG/mm ²)	16-12 / 1.3-3.3
Number of Poles	3 or 4
Circuits per foot	32
Torque(N*m)	1.4
Torque(lb-in)	12
Screw	#6-32
	WxHxD(mm)
3-Pole	30.2 x 49.3 x 47.8
4-Pole	39.2 x 49.3 x 47.8
Colors	Cat. no.
○ White (standard)	15188-3
○ White (standard)	15188-4
Accessories	Cat. no.
2 circuits	15188J-2-J, J15188
—	—
35mm DIN-Rail	DRL35MMLO DRL35MMHI
Reverse Wiring	15188- <u>R</u>
Locking	15188- <u>S</u>
Reverse; Locking	15188- <u>RS</u>

Options offered for both pole lengths

Dimensions — in (mm)

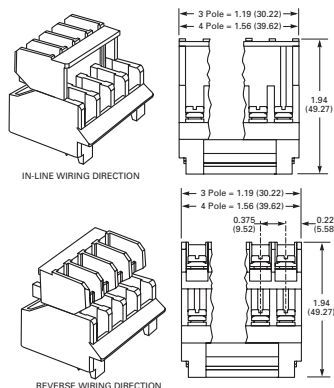

Approval	
Technical data	
Rated voltage	600V
Rated Current	40A
Center spacing in (mm)	0.39 / 9.91
Conductor cross-section, flexible (AWG/mm ²)	22-8 / 0.3-8.4
Number of Poles	3
Circuits per foot	28
Torque(N*m)	2
Torque(lb-in)	18
Screw	#8-32
	WxHxD(mm)
3-Pole	31.8 x 47.0 x 45.6
Colors	Cat. no.
○ White (standard)	PLU3-WH
● Black	PLU3-BK
Accessories	Cat. no.
2 circuits	JN3
—	MT12-1-2
C-Rail (AL)	NFTA NRA

Dimensions — in (mm)

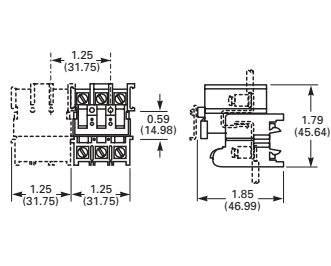

Approval	
Technical data	
Rated voltage	600V
Rated Current	70A
Center spacing in (mm)	0.3 / 7.62
Conductor cross-section, flexible (AWG/mm ²)	18-4 / 0.8-21.2
Number of Poles	1 - 3
Circuits per foot	19
Torque(N*m)	3.6
Torque(lb-in)	32
Screw	1/4 - 28
	WxHxD(mm)
1-Pole	18.5 x 47.0 x 45.6
2-Pole	34.0 x 47.0 x 45.6
3-Pole	49.5 x 47.0 x 45.6
Colors	Cat. no.
○ White (1-Pole)	PLU1-WH
○ White (2-Pole)	PLU11-WH
○ White (3-Pole)	PLU111-WH
Accessories	Cat. no.
2 circuits	JN1
—	MT12-1-2
C-Rail (AL)	NFTA NRA

Dimensions — in (mm)

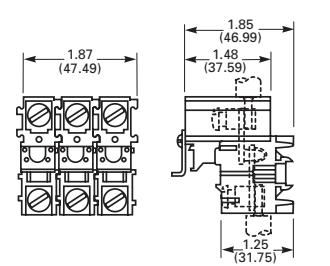

Block



Jumper

Marking tape

Mounting

Configurable Option

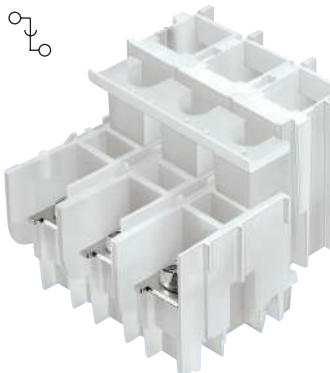

PSU1

Panel mount multi-pole blocks

Multi-pole panel mount terminal blocks provide a compact, high density circuit connection solution without the necessity of a mounting rail. These products are designed to be nested together to form one string of circuit connections.

UL E62622
CSA 15364

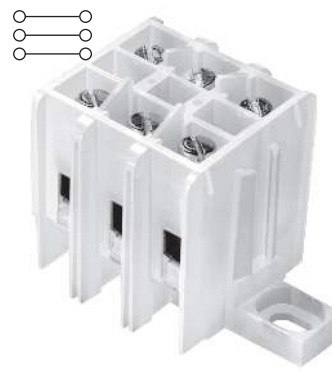

KT3

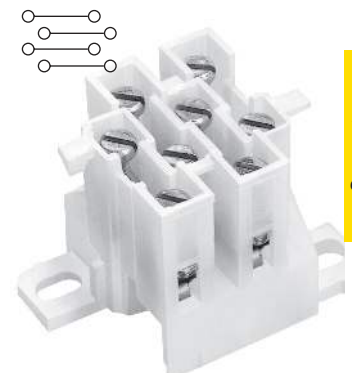

KT4

Connector products

Approval	
Technical data	
Rated voltage	600V
Rated Current	45A
Center spacing in (mm)	0.625 / 15.88
Conductor cross-section, flexible (AWG/mm ²)	Ring terminals only
Number of Poles	1 - 3
Circuits per foot	19
Torque(N•m)	2.7
Torque(lb-in)	24
Screw	#10-32
WxHxD(mm)	18.5 x 49.1 x 62.1
1-Pole	18.5 x 49.1 x 62.1
2-Pole	34.4 x 49.1 x 62.1
3-Pole	50.3 x 49.1 x 62.1
Colors	Cat. no.
○ White (1-Pole)	PSU1-WH
○ White (2-Pole)	PSU11-WH
○ White (3-Pole)	PSU111-WH
Accessories	Cat. no.
—	—
	MT12-1-2
C-Rail (AL)	NFTA NRA

Block



Jumper

Marking tape

Mounting

Approval	
Technical data	
Rated voltage	600V
Rated Current	40A
Center spacing in (mm)	0.39 / 9.91
Conductor cross-section, flexible (AWG/mm ²)	22-8 / 0.3-8.4
Number of Poles	3
Circuits per foot	28
Torque(N•m)	2
Torque(lb-in)	18
Screw	#8-32
WxHxD(mm)	59.5 x 31.8 x 31.0
Colors	Cat. no.
○ White (standard)	KT3-WH
Accessories	Cat. no.
2 circuits	JN3
	MT12-1-2
Panel mount	—
• Mounting foot	KAD
Dimensions — in (mm)	

Approval	
Technical data	
Rated voltage	600V
Rated Current	30A
Center spacing in (mm)	0.25 / 6.35
Conductor cross-section, flexible (AWG/mm ²)	22-10 / 0.3-5.3
Number of Poles	4
Circuits per foot	48
Torque(N•m)	2
Torque(lb-in)	18
Screw	#6-32
WxHxD(mm)	43.8 x 34.0 x 32.2
Colors	Cat. no.
○ White	KT4-WH-A*
○ White	KT4-WH-B*
Accessories	Cat. no.
4 circuits	JN4
	MTC6
Panel mount	—
Dimensions — in (mm)	

Dimensions — in (mm)

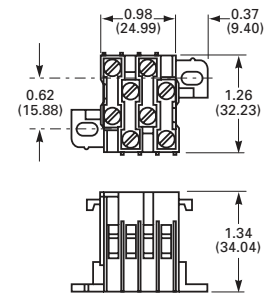
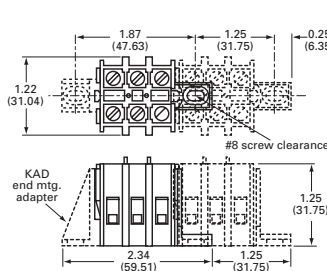
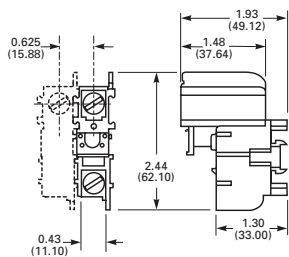

* The KT4 products are designed to be nested together to form one string of circuit connectors. When used in series, order catalog numbers KT4-WH-A and KT4-WH-B.

Panel mount quick-connect blocks

A time saving alternative for electrical connections, the Bussmann series quick-connect terminal blocks offer a convenient solution. With male spade terminals, wire connections are made quickly and simply with these terminal blocks.

UL E62622

CSA 15364



BNQ21



BQQ41

Approval	
Technical data	
Rated voltage	600V
Rated Current	40A
Center spacing in (mm)	0.437 / 11.1
Conductor cross-section, flexible (AWG/mm ²)	22-8 / 0.3-8.4
Number of Poles	1
Circuits per foot	24
Torque(N*m)	2
Torque(lb-in)	18
Screw	#8-32
WxHxD(mm)	33.3 x 35.8 x 37.3
Colors Cat. no.	
○ White (standard)	BNQ21-WH
Accessories Cat. no.	
—	—
Panel mount	—
• Mounting foot	BQE
Dimensions — in (mm)	

Approval	
Technical data	
Rated voltage	600V
Rated Current	30A
Center spacing in (mm)	0.437 / 11.1
Conductor cross-section, flexible (AWG/mm ²)	0.25" Quick-connect terminals only
Number of Poles	1
Circuits per foot	24
Torque(N*m)	NA
Torque(lb-in)	NA
Screw	NA
WxHxD(mm)	33.3 x 35.8 x 37.3
Colors Cat. no.	
○ White (standard)	BQQ41-WH
Accessories Cat. no.	
—	—
Panel mount	—
• Mounting foot	BQE
Dimensions — in (mm)	

Block



Mounting

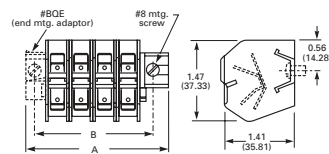
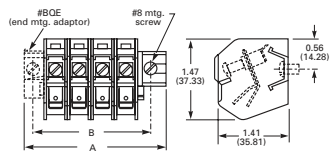

C7021 power feed through terminal blocks

Power feed through terminal block with two rows 1/4-20 studs capable of accommodating the industry standard two-hole compression lugs on both studs in parallel.



Ratings

- Volts 300 V
- Amps 115/175 A* per pole
- * 175 achieved using both studs in parallel, 115 A using a single stud per line.

Agency information

- UL/CSA, CE

Specifications

- Poles: 1- to 6
- Wire range: AWG #3/0-8
- Center spacing: 0.69" (18mm)
- Bolt hole spacing: 0.625" or 5/8" (16mm)
- Stud: Standard 1/4-20 stud (tin-plated brass) or optional M6 stud.
- Mounting: #6 thread cutting screws (not included) or optional mounting ends.
- Torque: 36 lb-in.
- Operating temperature: 130°C (266°F) max.

Typical applications

- Applications requiring up to 175 A utilizing a 2-hole compression lug on 5/8" centers
- Input/output block for telecommunications power panels
- To eliminate busbars

Dimensions — mm (in)

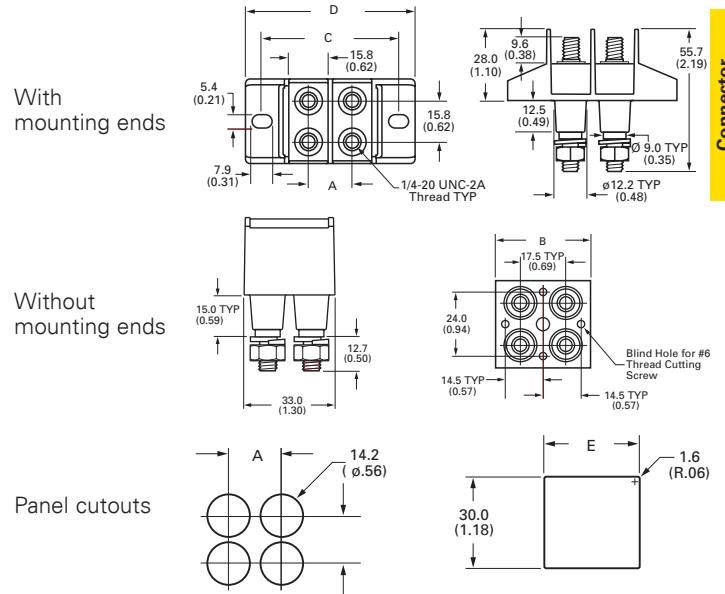

Catalog no.	A	B	C	D	E
C7021-01-X with mounting ends					
C7021-02-X	17.5 (0.69)	—	54.4 (2.14)	67.3 (2.65)	31.8 (1.25)
C7021-03-X	34.9 (1.37)	—	70.9 (2.83)	84.8 (3.34)	49.2 (1.94)
C7021-04-X	52.3 (2.06)	—	89.3 (3.52)	102.2 (4.02)	66.7 (2.63)
C7021-05-X	69.8 (2.75)	—	106.8 (4.20)	119.7 (4.71)	84.2 (3.31)
C7021-06-X	87.2 (3.44)	—	124.2 (4.89)	134.1 (5.40)	101.7 (4.00)
C7021-01N-X without mounting ends					
C7021-02N-X	17.5 (0.69)	36.1 (1.42)	—	—	31.8 (1.25)
C7021-03N-X	34.9 (0.69)	53.5 (2.11)	—	—	49.2 (1.94)
C7021-04N-X	52.3 (2.06)	71.0 (2.80)	—	—	66.7 (2.63)
C7021-05N-X	69.8 (2.75)	88.4 (3.48)	—	—	84.2 (3.31)
C7021-06N-X	87.2 (3.44)	105.9 (4.17)	—	—	101.7 (4.00)

Catalog number build-a-code

Symbol	Poles	Mount ends	Studs	Hardware
C7021				—
	01 = 1-pole (2 studs)	Blank = Mount ends	Blank = Standard	Blank = No hardware
	02 = 2-pole (4 studs)	N = No mount ends	M6 = M6 studs	0 = Bulk pack, one set
	03 = 3-pole (6 studs)			1 = Bulk pack, two sets
	04 = 4-pole (8 studs)			2 = Assembled, bottom
	05 = 5-pole (10 studs)			3 = Assembled, top
	06 = 6-pole (12 studs)			4 = Assembled, both sets

TB100 double row terminal blocks

Ratings*

- 300 V
- 30 A
- Breakdown voltage: 3600 V

* Maximum rating shown; some options may be rated lower.



Agency information

- UL File E62622/CSA File 47235; IEC Compliance, CE

Specifications

- Poles: 2 to 36
- Center spacing: 0.375" or 3/8" (10mm)
- Wire range: 14-22 AWG Cu
- Screw size: #6-32 phil-slot screws
- Torque rating: 9 lb-in
- Distance between barriers: 0.30" (8mm)
- Mounting: #6 screws
- Operating temperature: -40°C to 130°C (-40°F to 266°F)

Materials

- Molded black thermoplastic base, UL rated 94V0
- Tin-plated brass terminals
- Zinc-plated steel screws

Dimensions — in

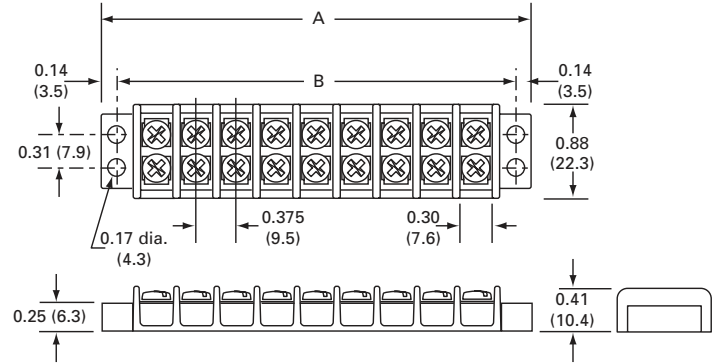

Poles	A	B	Poles	A	B	Poles	A	B
02	1.40	1.12	14	5.90	5.62	26	10.40	10.12
03	1.78	1.50	15	6.28	6.00	27	10.78	10.50
04	2.16	1.88	16	6.66	6.38	28	11.16	10.88
05	2.53	2.25	17	7.03	6.75	29	11.53	11.25
06	2.90	2.62	18	7.40	7.12	30	11.90	11.62
07	3.28	3.00	19	7.78	7.50	31	12.28	12.00
08	3.66	3.38	20	8.16	7.88	32	12.66	12.38
09	4.03	3.75	21	8.53	8.25	33	13.03	12.75
10	4.40	4.12	22	8.90	8.62	34	13.40	13.12
11	4.78	4.50	23	9.28	9.00	35	13.78	13.50
12	5.16	4.88	24	9.66	9.38	36	14.16	13.88
13	5.53	5.25	25	10.03	9.75			

1" = 25.4mm.

Catalog number build-a-code

Symbol	Poles	Screw options	Marking/cover	Hardware options
TB100	—			
	02 to 36	Blank = steel phil-slot, zinc-plated 00 = screws shipped bulk B = brass phil-slot, nickel-plated SP = steel SEMS phil-slot, zinc-plated	L1 to L6 Marking options, see page 10-16 Special markings [†] , see page 10-16	QC1 to QC20 = Quick-connects Custom options[†] J101 = flat slip-on jumper (2 position only) OJ2 = over barrier jumpers OJ4 = over barrier jumpers

[†] Contact factory for configuration.

Accessories

- Marker strips, see page 10-17
- Covers, see page 10-16

Screw options



B

Brass phil-slot, nickel-plated
F502-J (bulk)

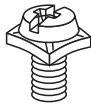

SP

Steel SEMS phil-slot, zinc-plated
B001-7021-J (bulk)

Hardware options

Quick-connects — assembled: 0.187" x 0.020" terminals, 13 amps maximum. For other orientations, contact factory.

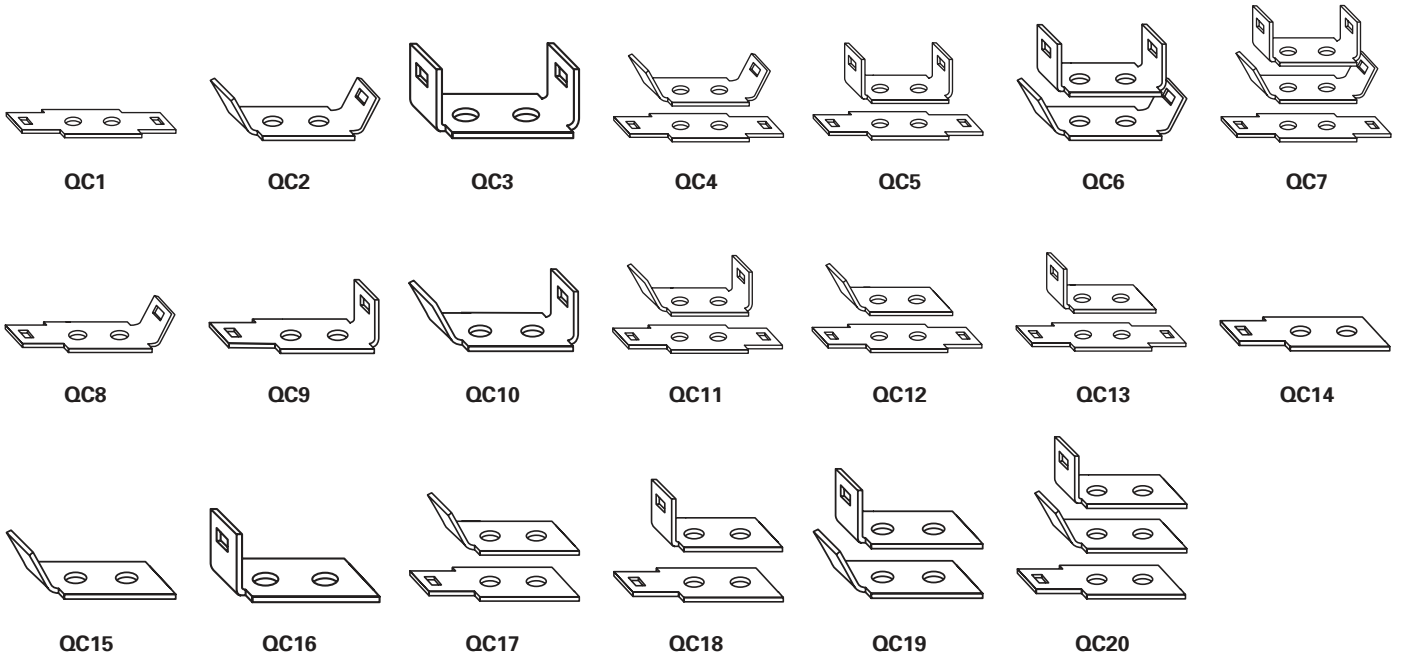

Quick-connects — bulk: minimum order 100 pieces per catalog number.

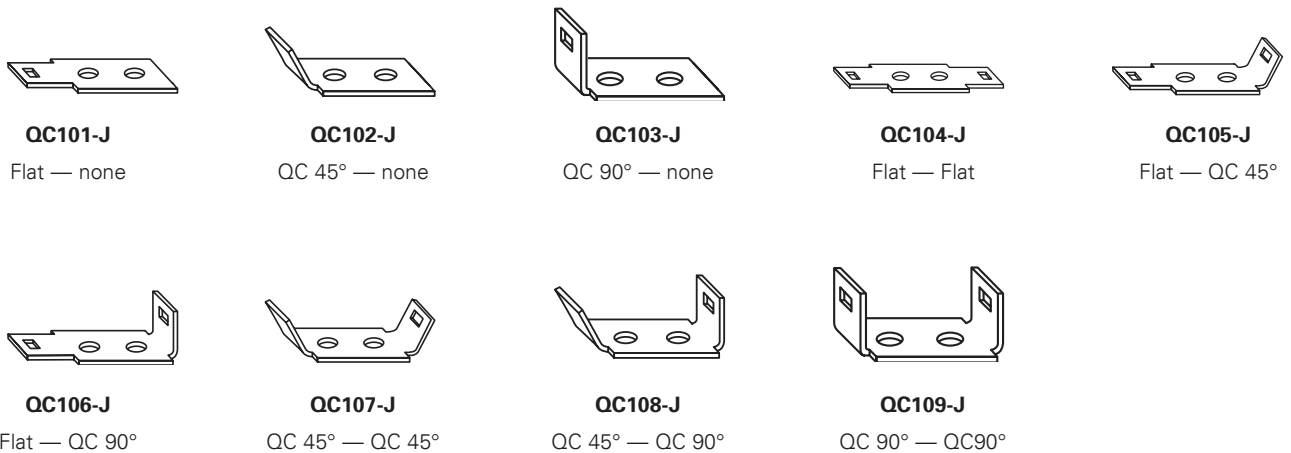

Jumpers — bulk: minimum order 100 pieces per catalog number. Contact factory for jumper assembly.

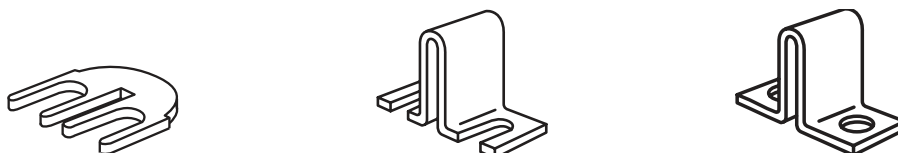

J101

Flat slip-on (bulk: **J101-J**)

OJ2

Slip-on over barrier (bulk: **OJ2-J**)

OJ4

Closed over barrier (bulk: **OJ4-J**)

TB200 and TB200HB double row terminal blocks

Ratings*

- Volts
 - 300 V (TB200)
 - 600 V (TB200HB)
- Amps 30 A
- Breakdown voltage 4800 V

* Maximum rating shown; some options may be rated lower.

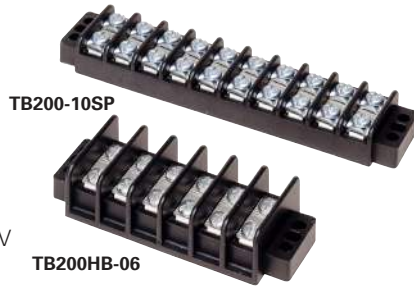

Agency information

- UL File E62622, CSA File 47235 and 15364; IEC Compliance, CE

Specifications

- Poles: 2 to 30
- Wire range: 12 - 22 AWG Cu
- Center spacing: 0.437" or 7/16" (11mm)
- Distance between barriers: 0.353" (9mm)
- Screw size: #6-32 phil-slot screws
- Torque rating: 9 lb-in
- Mounting: #6 screws
- Operating temperature: -40°C to 130°C (-40°F to 266°F)

Materials

- Molded black thermoplastic base UL rated 94V0
- Terminal plating: Tin-plated brass terminals
- Zinc-plated steel screws

Dimensions — in

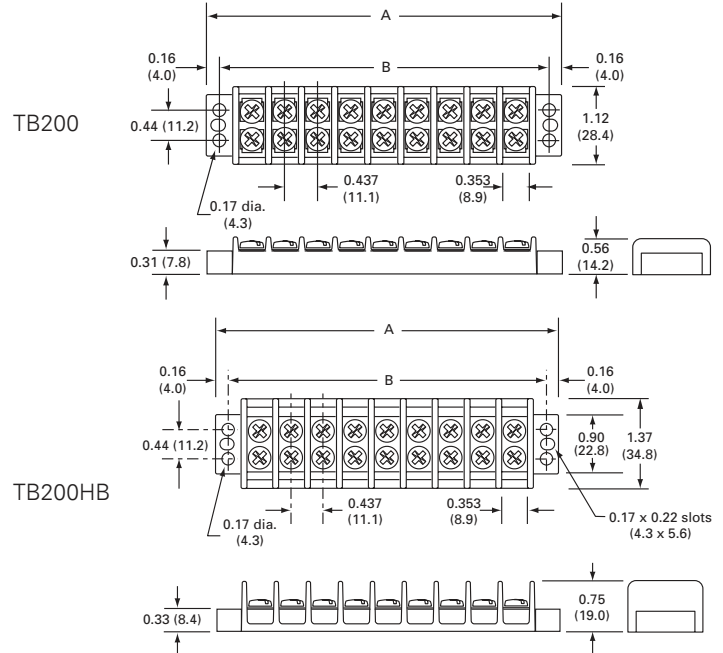

Poles	A	B	Poles	A	B	Poles	A	B
02	1.63	1.31	12	6.00	5.68	22	10.37	10.06
03	2.07	1.75	13	6.44	6.12	23	10.81	10.50
04	2.51	2.18	14	6.87	6.56	24	11.25	10.93
05	2.94	2.62	15	7.31	7.00	25	11.68	11.37
06	3.38	3.06	16	7.75	7.43	26	12.12	11.81
07	3.82	3.50	17	8.19	7.87	27	12.56	12.25
08	4.25	3.93	18	8.62	8.31	28	13.00	12.68
09	4.69	4.37	19	9.06	8.75	29	13.44	13.12
10	5.13	4.81	20	9.50	9.18	30	13.87	13.56
11	5.57	5.25	21	9.94	9.62			

1" = 25.4mm.

Catalog number build-a-code

Symbol	Barrier style	Poles	Screw options	Marking/cover	Hardware options
TB		—			
	200 = Standard	02 to 30	Blank = Steel phil-slot, zinc-plated	L1 to L6 = Marking options, see page 10-16	QC1 to QC20 = Quick-connects
	200HB = High barrier		00 = Screws shipped bulk	Special markings†, see page 10-16	Custom options†
			B = Brass phil-slot, nickel-plated		J201 = Flat slip-on jumper, 2 position only
			BS = Brass SEMS phil-slot, nickel-plated		0J3 = Over barrier jumpers
			P = Steel SEMS (P-style)		0J5 = Over barrier jumpers
			SP = Steel SEMS phil-slot, zinc-plated		0J7 = Over barrier jumpers
			SS = Stainless steel SEMS, phil-slot		
			ST = Stainless steel, phil-slot		

† Contact factory for configuration.

Accessories

- Marker strips, see page 10-17
- Covers, see page 10-16

Screw options



B

Brass phil-slot
nickel-plated
B001-7016-J (bulk)



BS

Brass SEMS phil-slot
nickel-plated
B001-7019-J (bulk)

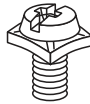

SP

Steel SEMS phil-slot
zinc-plated
B001-7007-J (bulk)



P

Steel SEMS
(P-style)
B001-7000-J (bulk)



ST

Stainless steel phil-slot
F507-J (bulk)

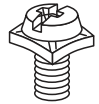

SS

Stainless steel SEMS
phil-slot
B001-7085-J (bulk)

Hardware options

Quick-connects — assembled: 0.25" x 0.031" terminals, 20 amps maximum. For other orientations, contact factory.

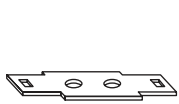

QC1

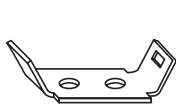

QC2

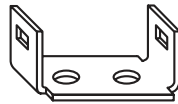

QC3

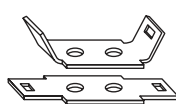

QC4

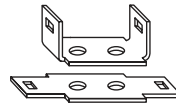

QC5

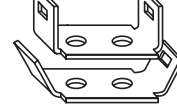

QC6

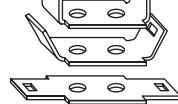

QC7

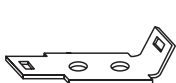

QC8



QC9



QC11

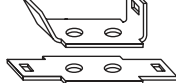

QC10

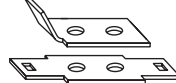

QC12

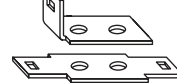

QC13



QC14



QC15

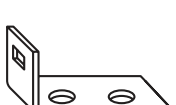

QC16

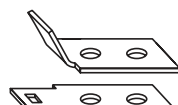

QC17

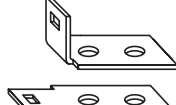

QC18

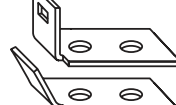

QC19

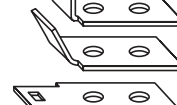

QC20

Quick-connects — bulk: minimum order 100 pieces per catalog number.

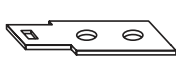

QC201-J

QC 45° — blank

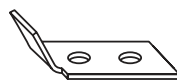

QC202-J

Flat — blank

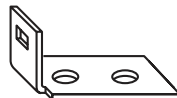

QC203-J

QC 90° — blank

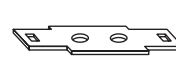

QC204-J

Flat — Flat

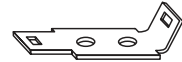

QC205-J

Flat — QC 45°



QC206-J

Flat — QC 90°



QC207-J

QC 45° — QC 45°



QC208-J

QC 45° — QC 90°



QC209-J

QC 90° — QC 90°

Jumpers — bulk: minimum order 100 pieces per catalog number. Contact factory for jumper assembly.



J201

Flat slip-on
(not available on TB200HB)
J201-J (bulk)

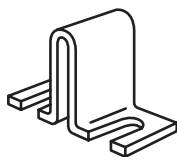

OJ3

Slip-on over barrier for TB200HB
OJ3-J (bulk)

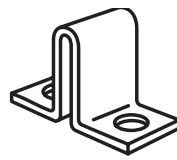

OJ5

Closed over barrier for TB200HB
OJ5-J (bulk)

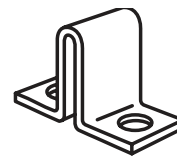

OJ7

Closed over barrier for TB200
OJ7-J (bulk)

TB300 and TB345 double row terminal blocks

Ratings*

- Volts 600 V
- Amps
 - 30 A (TB300)
 - 45 A (TB345)
- Breakdown voltage 7500 V

* Maximum rating shown; some options may be rated lower.



Agency information

UL File E62622, CSA File 47235; IEC Compliance, CE

Specifications

- Poles: 2 to 24
- Wire range: 8 - 22 AWG Cu
- Center spacing: 0.562" or 9/16" (14mm)
- Screw size
 - TB300 — #8-32 phil-slot screws
 - TB345 — #10-32 phil-slot screws
- Torque rating
 - #8 screws - 16 lb-in
 - #10 screws - 20 lb-in
- Distance between barriers: 0.41" (10mm)
- Mounting
 - TB300 — #8 screws
 - TB345 — #10 screws
- Operating temperature: -40°C to 130°C (-40°F to 266°F)

Materials

- Molded black thermoplastic base, UL rated 94V0
- Tin-plated brass terminals
- Zinc-plated steel screws

Catalog number build-a-code

Symbol	Screw size	Poles	Screw options	Marking/cover	Hardware options
TB		—			
	300 = 8-32 screw	02 to 24	Blank = Steel phil-slot, zinc-plated	L1 to L6 marking options, see page 10-16	QC1 to QC20 = Quick-connects (TB300 only)
	345 = 10-32 screw		00 = Screws shipped bulk B = Brass phil-slot, nickel-plated BS = Brass SEMS phil-slot, nickel-plated (TB300 only) SP = Steel SEMS phil-slot, zinc-plated ST = Stainless steel, phil-slot	Special markings†, see page 10-16	Custom options (TB300 only)† J301 = Flat slip-on jumper OJ6 = Over barrier jumper OJ11 = Over barrier jumper

† Contact factory for configuration.

Accessories

- Marker strips, see page 10-17
- Covers, see page 10-16

Dimensions — in

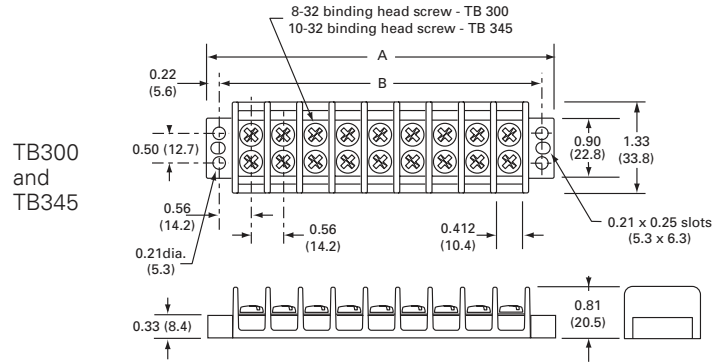

Poles	A	B	Poles	A	B	Poles	A	B
02	2.13	1.69	10	6.62	6.19	18	11.12	10.68
03	2.69	2.25	11	7.18	6.75	19	11.68	11.25
04	3.25	2.81	12	7.75	7.31	20	12.24	11.81
05	3.81	3.37	13	8.31	7.87	21	12.80	12.37
06	4.37	3.94	14	8.87	8.44	22	13.37	12.93
07	4.94	4.50	15	9.43	9.00	23	13.93	13.50
08	5.50	5.06	16	9.99	9.56	24	14.49	14.06
09	6.06	5.62	17	10.56	10.12			

1" = 25.4mm.

Screw options



B

Brass phil-slot nickel-plated
- **B001-7018-J** (TB300 bulk)
- **B500-023-028-J** (TB345 bulk)



BS

Brass SEMS phil-slot nickel-plated
- **B001-7015-J** (TB300 bulk)



SP

Steel SEMS phil-slot zinc-plated
- **B001-7017-J** (TB300 bulk)
- **B001-5774-J** (TB346 bulk)



ST

Stainless steel phil-slot
- **B001-7063-J** (TB300 bulk)
- **B001-7064-J** (TB345 bulk)

Hardware options

Quick-connects — assembled: TB300 only; 0.25" x 0.031" terminals, 20 amps maximum. For other orientations, contact factory.

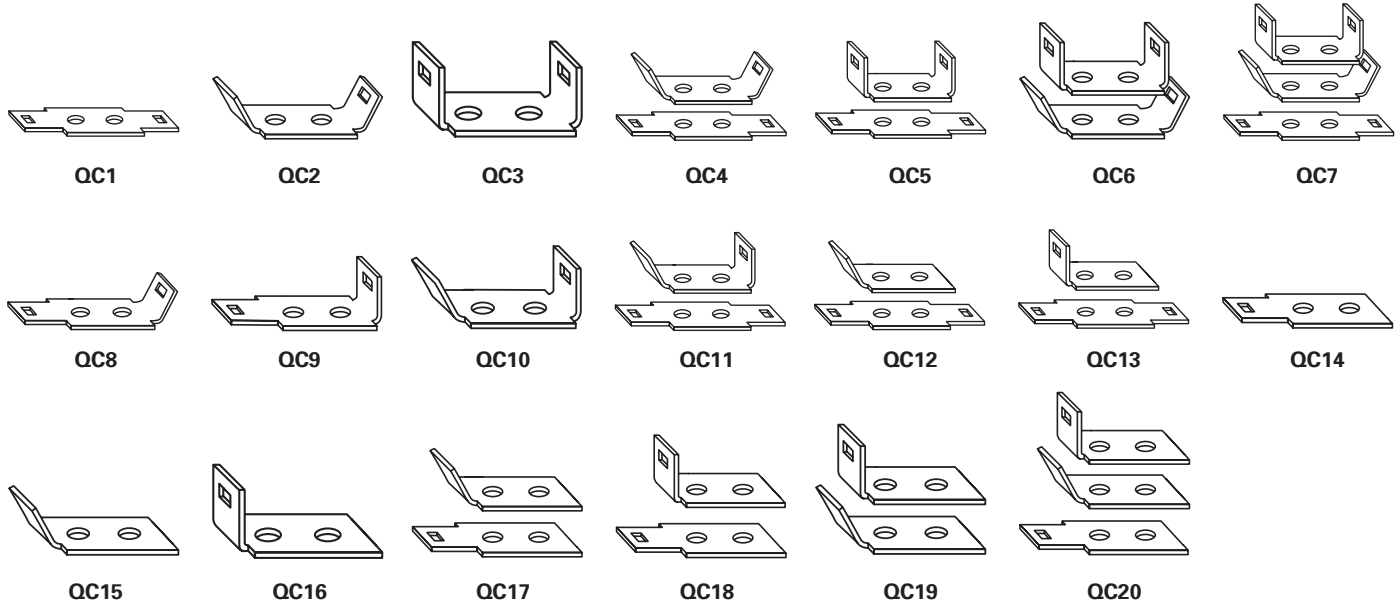

Quick-connects — bulk: *TB300 only; minimum order 100 pieces per catalog number.

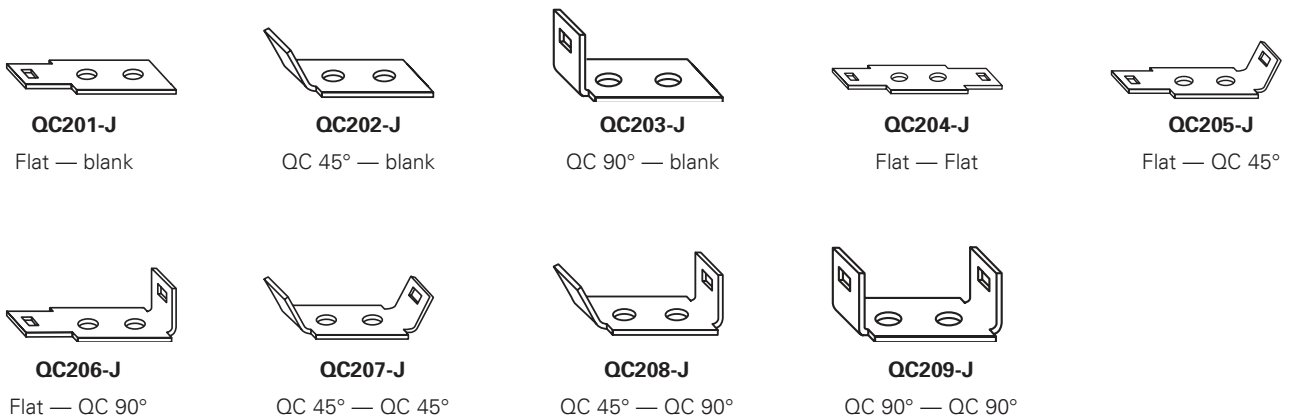

Jumpers — bulk: TB300 only; minimum order 100 pieces per catalog number. Contact factory for jumper assembly.

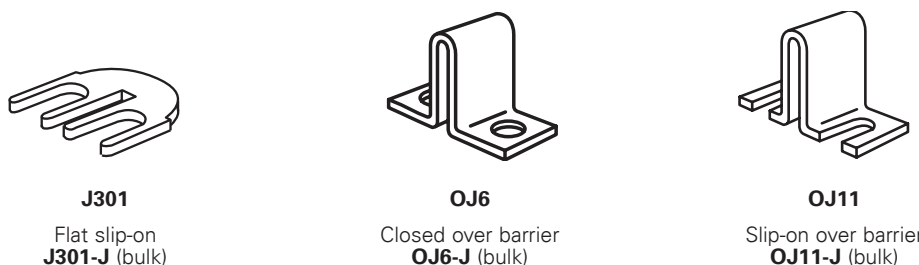

Marking options and covers for double row terminal blocks

Standard marking

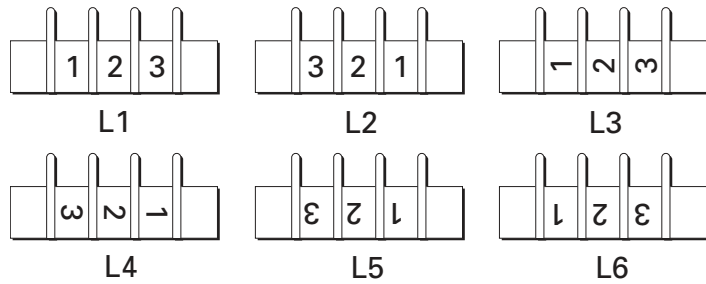

Standard markings are applied directly to the side(s) of a block. The standard marking color is white. The standard numeral height is 0.125 inches (3mm).

Note: Blocks marked on both sides require a different code for each side. Example: Style L1 on one side of the block requires Style L2 on the other side to ensure common terminal marking. To order, add appropriate suffix (L1, L2, L3, L4, L5 and/or L6) to block catalog number in the proper sequence.

Special marking*

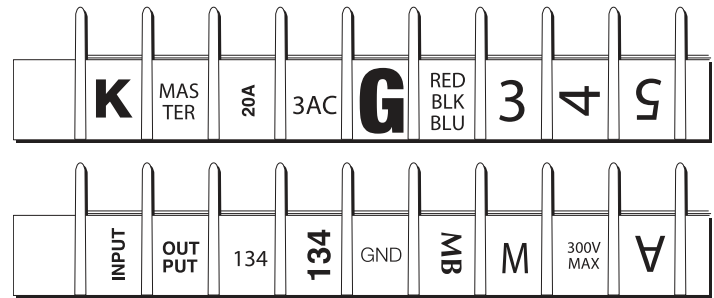

Special markings are available at an additional charge. Drawing(s) must be submitted to ensure accuracy of part required. Consult factory for price and delivery.

* Not available on TB400 products

Covers

(must be ordered separately)

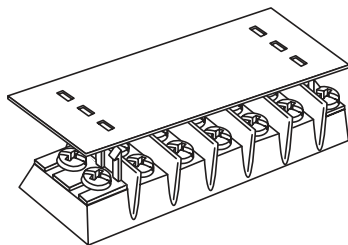

Covers prevent personnel, screws and foreign items from contacting live terminals, and are available in white (opaque) or clear plastic. Two cover clips are supplied with each cover. The cover width is 1.31 inches (33mm). Example: 10 position cover, white, TB100 = catalog number X12010.

Cover catalog number build-a-code†

Symbol	Cover strip†	Poles	High barrier option only
X			
	119 = TB100 - clear	02 to 36 (TB100)	HB = High barrier††
	120 = TB100 - white	02 to 30 (TB200/ TB200HB)	
	219 = TB200/TB200HB - clear	02 to 24 (TB300/ TB345)	
	220 = TB200/TB200HB - white		
	319 = TB300/TB345 - clear		
	320 = TB300/TB345 - white		

† Cover strip not available for TB400 products.

††Applicable to X219 and X220 only.

Cover clips — bulk

Catalog no.	For block family
DD1-J	TB100
DD2-J	TB200
DD2HB-J	TB200HB
DD3-J	TB300

Top marker strips
(order separately from blocks)

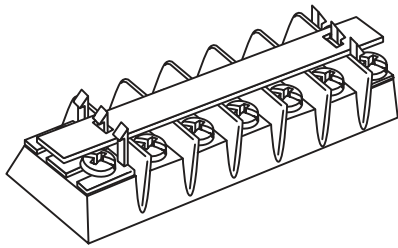

Top mounting marker strips must be ordered separately and are only available in white (opaque) plastic. Two cover clips are supplied with each marker strip.

Example: 12 position cover, TB200, 0.032" x 0.312" = catalog number X20312.

Example: 12 position cover, TB200HB, 0.06" x 0.50" = catalog number X23312HB.

Top marker strip catalog number build-a-code

Series	Top marker strip [†]	Poles	High barrier option only
X			
	103 = TB100 (0.032 thk x 0.312 w)	02 to 36 (TB100)	HB = High barrier ^{††}
	133 = TB100 (0.060 thk x 0.500 w)	02 to 30 (TB200/TB200HB)	
	203 = TB200/TB200HB (0.032 thk x 0.312 w)	02 to 24 (TB300/TB345)	
	233 = TB200/TB200HB (0.060 thk x 0.500 w)		
	303 = TB300/TB345 (0.032 thk x 0.380 w)		
	333 = TB300/TB345 (0.060 thk x 0.500 w)		

[†] Marking strips not available for TB400 products
^{††}Applicable to X203 and X233 only.

Bottom marker strips
(order separately from blocks)

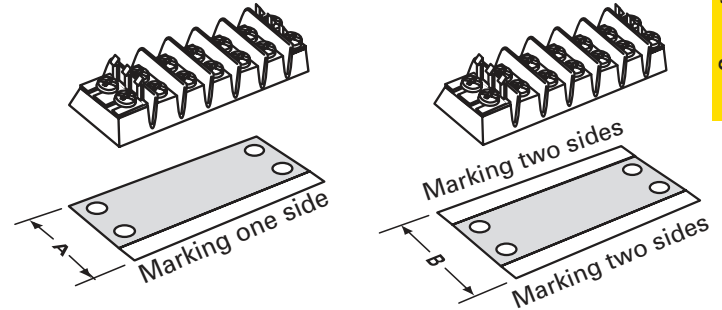

Bottom mounting marker strips are made of 0.03" thick black PVC. Space is available along the edge to handle most marking needs. All marker strips must be ordered separately.

To order, specify catalog number and required marking orientation. Example: 13 position strip, TB100 with no markings, space for marking one side = catalog number X10513. Consult factory for specials.

Standard numeral height is 0.125". Standard markings are 0-99. Special markings are available on special order. Drawing(s) must be submitted to ensure accuracy of part required.

Dimensions — in

Dim.	For TB block					
	TB100	TB200	TB200HB	TB300	TB345	TB400
A	1.13	1.37	1.62	1.58	1.58	N/A
B	1.38	1.62	1.81	1.81	1.81	N/A

Bottom marker strip catalog number build-a-code

Symbol	Bottom Marker Strip [†]	Poles	Marking orientation
X			
	101 = TB100 marking both sides	02 to 36 (TB100)	BF = Bottom forward
	105 = TB100 marking one side	02 to 30 (TB200/TB200HB)	BR = Bottom reverse
	201 = TB200 marking both sides	02 to 24 (TB300/TB345)	TF = Top forward
	205 = TB200 marking one side		TR = Top reverse
	291 = TB200HB marking both sides		
	295 = TB200HB marking one side		
	301 = TB300 and TB345 marking both sides		
	305 = TB300 and TB345 marking one side		

[†] Not available for TB400 products.

TB400 double row terminal blocks

Ratings

- Volts 600 V
- Amps 75 A
- Breakdown voltage 7500 V



Agency information

- UL File E62622, CSA File 47235; IEC Compliance, CE

Specifications

- Poles: 2 to 12
- Wire range: 6-14 AWG Cu
- Center spacing: 0.687" or 11/16" (17mm)
- Distance between barriers: 0.56" (14mm)
- Screw size: #10-32 phil-slot screws
- Torque rating: 20 lb-in
- Mounting: #10 screws
- Operating temperature: -40°C to 130°C (-40°F to 266°F)

Materials

- Molded black thermoplastic base, UL rated 94V0
- Tin-plated brass terminals
- Zinc-plated steel screws

Dimensions — in

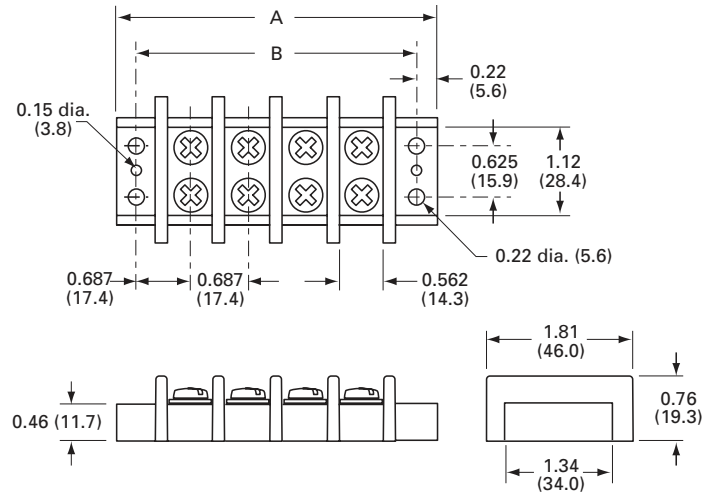

Poles	A	B	Poles	A	B	Poles	A	B
02	2.51	2.06	06	5.26	4.81	10	8.01	7.56
03	3.20	2.75	07	5.95	5.50	11	8.70	8.25
04	3.89	3.44	08	6.64	6.19	12	9.39	8.94
05	4.58	4.13	09	7.33	6.88			

1" = 25.4mm.

Screw options



Brass nickel-plated phil-slot
B500-023-028-J (bulk)



Stainless steel phil-slot
B001-7064-J (bulk)

Hardware options

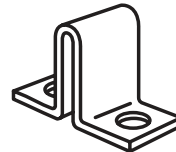

OJ14: Closed over barrier
OJ14-J (bulk)

Catalog number build-a-code

Symbol	Poles	Screw options
TB400	—	

02 to 12 = Pole count
Blank = Zinc-plated steel phil-slot
00 = Screws shipped bulk
B = Nickel-plated brass phil-slot
ST = Stainless steel, phil-slot

Accessories

- **OJ14** - Jumper over barrier, consult factory for pole configuration

KU double row terminal blocks

Ratings

- Volts 600 V
- Amps 60 A*
- * 60 A rating achieved with 6 AWG Cu wire crimped to ring terminal.

Agency information

- UL File E62622, CSA File 47235, CE

Specifications

- Poles: 2 to 12
- Wire range: 6-22 AWG Cu
- Center spacing: 0.625" (16mm)
- Screw size: #10-32
- Torque rating: 20 lb-in
- Distance between barriers: 0.437" (11mm)
- Mounting: Panel mount
- Operating temperature: 105°C (221°F) max.

Materials

- Molded black Noryl base, UL rated 94V1
- Terminal plating: Nickel-plated brass terminals
- Zinc-plated steel screws

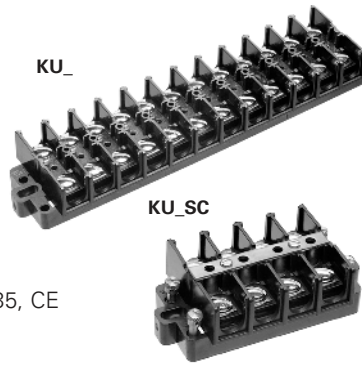

Dimensions — in

Poles	KU		KUX only
	A	B	A
02	2.50	1.62	2.00
04	3.75	2.87	3.25
06	5.00	4.12	4.50
08	6.25	5.37	5.75
10	7.50	6.62	7.00
12	8.75	7.87	8.25

1" = 25.4mm.

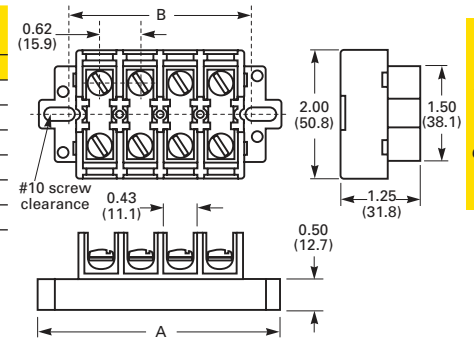

Accessories (order separately)

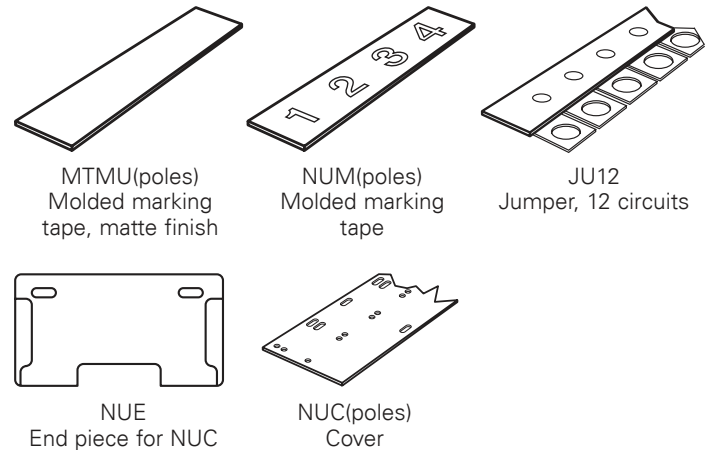

Catalog number build-a-code - KU versions

Symbol / for	Poles	Screw options	Covers	Marking strip
KU / Standard block	2 4 6 8 10 12	00 = Screws shipped bulk	WC = Top cover and 2 end plates	MT = Matte finish
KUX / Short block		BP = Brass phil-slot, nickel-plated		NU = Numbered 1 to 12, horizontal
KURL / Standard w/removable link		P = Steel screw w/pressure plate zinc-plated		NUV = Numbered 1 to 12, vertical
KUXRL / Short block w/removable link		W = Brass washer head, nickel-plated		PT = Marker strip for cover†

Catalog number build-a-code - KU_SC versions

Symbol / for	Poles	Screw options	Covers	Marking strip
KUSC / Standard w/shorting strap and 4 shorting screws	2 4 6 8 10 12	00 = Screws shipped bulk	WC = Top cover and 2 end plates	PT = Marker strip for cover†
KUXSC / Short block w/shorting strap and 4 shorting screws		BP = Brass phil-slot, nickel-plated		
		P = Steel screw w/pressure plate, zinc-plated		
		W = Brass washer head, nickel-plated		

† Requires WC cover option

End brackets

BRKT-ND

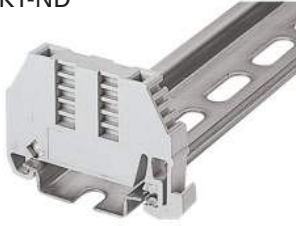

Use with DRL35MMHI
DRL35MMLO

Dimensions — mm

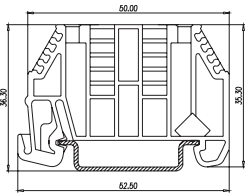

BRKT-NDSCRW



Use with DRL35MMHI
DRL35MMLO

Dimensions — mm

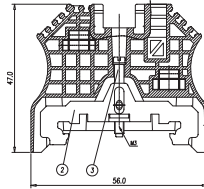

BRKT-NDSCRW2



Use with DRL35MMHI
DRL35MMLO

Dimensions — mm

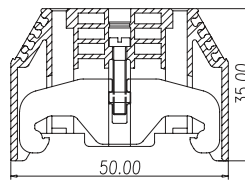

BRKT-NDSCRW3



Use with DRL35MMHI
DRL35MMLO

Dimensions — mm

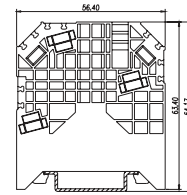

Mounting rails and brackets

DRL35MMLO*

Low profile
35mm DIN-Rail



DRL35MMHI*

High profile
35mm DIN-Rail



NFTA**

C-Rail



NRA**

C-Rail



BRKT-ANGL

Angle bracket



BRKT-FLT

Flat bracket



* Available in 1 meter lengths only.

** Cut-to-length. Consult your Bussmann series product representative for details.