



Moisture Sensitivity Level (MSL) – 1

FEATURES:

- Excellent phase noise performance
- Low power consumption
- Miniature size: 2.5 x 2.0 x 0.8mm SMD
- RoHS compliant
- Frequency stability: $\pm 0.5\text{ppm}$ over $-40 \sim +85^\circ\text{C}$
- Precision TCXO processing technology by Rakon

APPLICATIONS:

- Decawave DW1000 (IEEE802.15.4-2011 UWB)
- UWB applications
- Real Time Location Systems
- Wireless Sensor Networks

STANDARD SPECIFICATIONS:

Parameters	Minimum	Typical	Maximum	Units	Notes
Nominal Frequency	38.400			MHz	
Supply Voltage (Vdd)	3.14	3.3	3.46	V	
Current Consumption (@Vdd max)			2.0	mA	See Note 2
Operating Temperature Range	-40		+85	$^\circ\text{C}$	
Storage Temperature Range	-40		+85	$^\circ\text{C}$	
Initial Frequency Tolerance @+25 $^\circ\text{C} \pm 2^\circ\text{C}$ at time of shipment			± 1	ppm	
Reflow Shift			± 1	ppm	After 2 consecutive reflows and 1hr recovery@+25 $^\circ\text{C}$
Frequency Stability over Operating Temperature Range			± 0.5	ppm	Ref. to $(F_{\text{MAX}} + F_{\text{MIN}})/2$. See Note 1
Sensitivity vs. Supply Voltage Variations (Vdd $\pm 5\%$ @ +25 $^\circ\text{C}$)			± 0.1	ppm	
Sensitivity vs. Load Variations ($\pm 10\%$ load change @ +25 $^\circ\text{C}$)			± 0.2	ppm	See Note 2
Long Term Stability (frequency drift over 1 year @ +25 $^\circ\text{C}$)			± 1.0	ppm	
Output Type	DC Coupled Clipped Sine-wave				See Note 3
Output Voltage Level (@ minimum Vdd)	0.8			V	See Note 2
Output Load Resistance	9	10	11	k Ω	
Output Load Capacitance	9	10	11	pF	
Startup Time (amplitude)			0.5	ms	Within 90% of specified output level
Startup Time (frequency)			2	ms	Within $\pm 0.5\text{ppm}$ of steady state frequency
Phase Noise @ 38.400MHz Carrier (@+25 $^\circ\text{C}$)	@ 1 Hz offset	-60		dB/Hz	
	@ 10 Hz offset	-88			
	@ 100 Hz offset	-109			
	@ 1 kHz offset	-132			
	@ 10 kHz offset	-149			
	@ 100 kHz offset	-150			

Notes:

1. Parts should be shielded from drafts causing unexpected thermal gradients. Temperature changes due to ambient air currents on the oscillator can lead to short term frequency drift
2. Specified for load stated in the Output Load section at +25 $^\circ\text{C}$
3. AC-Coupled outputs require an external capacitor, $\geq 1\text{nF}$ recommended
4. Frequency shift $\leq 1\text{ppm}$ after reliability test conditions (see section 8.0)



2.5 x 2.0 x 0.8mm

ASTXR-12-38.400MHz-514054-T

Pb | RoHS / RoHS II Compliant

PART IDENTIFICATIONS:

ASTXR-12-38.400MHz -514054 -

Packing	
Blank:	Bulk
T:	Tape & Reel (3k/reel)

TEST CIRCUIT:

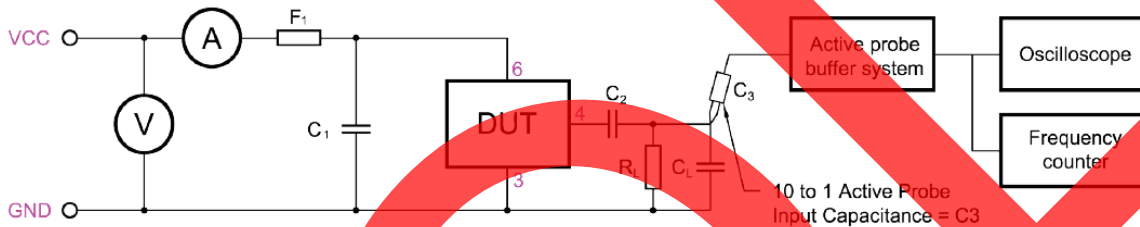

C₁: 100nF
C₂: ≥1nF
R_L: 10K

$C_T = C_L + C_3$ (C₃ - Oscilloscope probe capacitance)
C_T as stated in OSCILLATOR OUTPUT section
F₁: A ferrite bead or a resistor between 22Ω ~ 47Ω recommended.

OUTLINE DIMENSION:

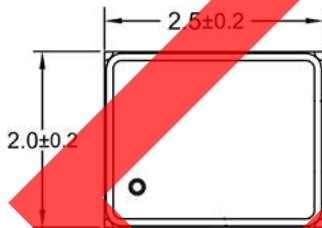

TOP VIEW

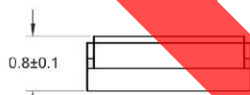

FRONT VIEW

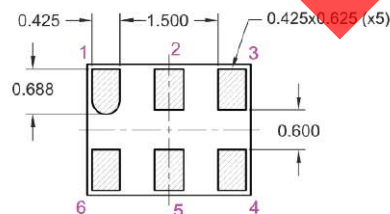

BOTTOM VIEW

Recommended Land Pattern

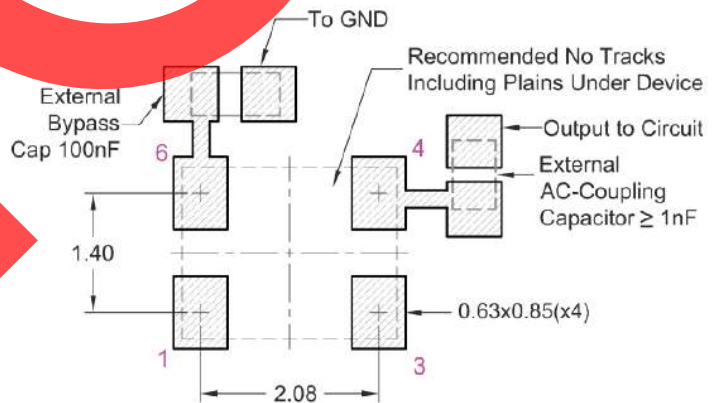

Pin	Function
1	NC/GND
2	NC/GND
3	GND
4	Output
5	NC/GND
6	Vdd

Dimensions: mm

SMD TCXO

ASTXR-12-38.400MHz-514054-T



RoHS / RoHS II Compliant



2.5 x 2.0 x 0.8mm

REFLOW PROFILE:

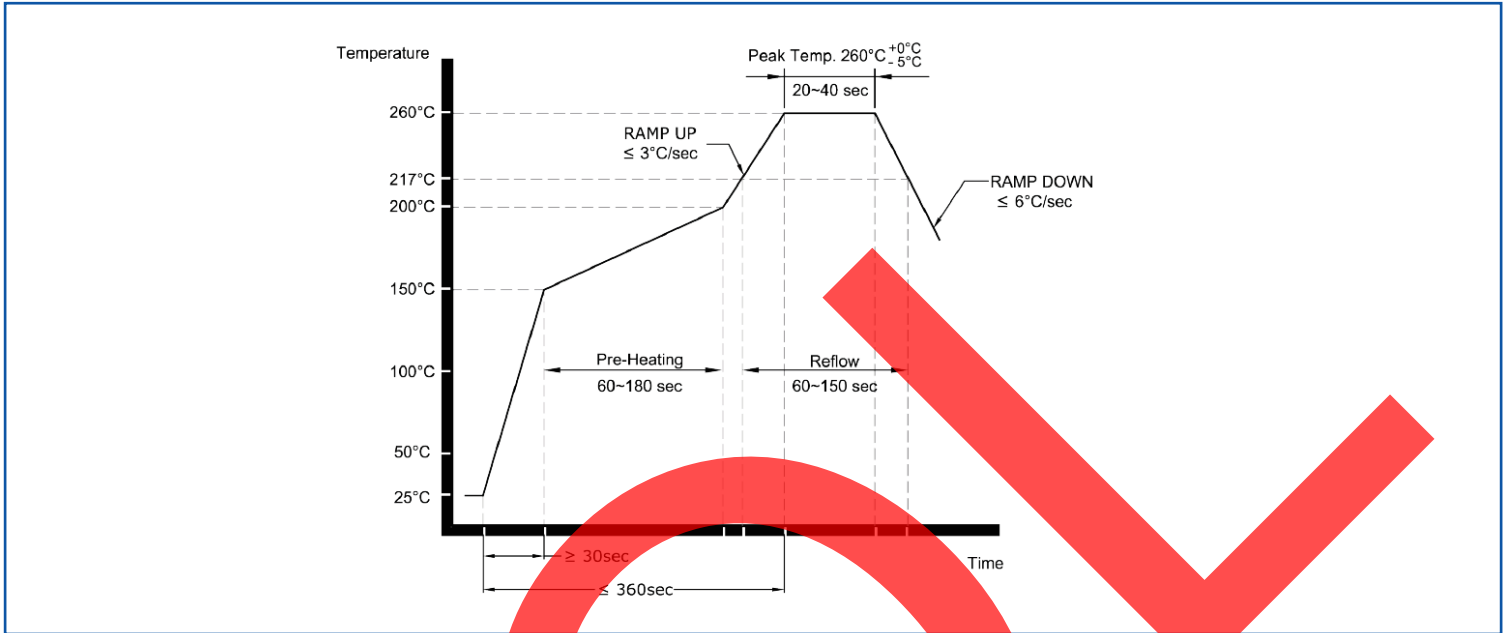

TAPE & REEL:

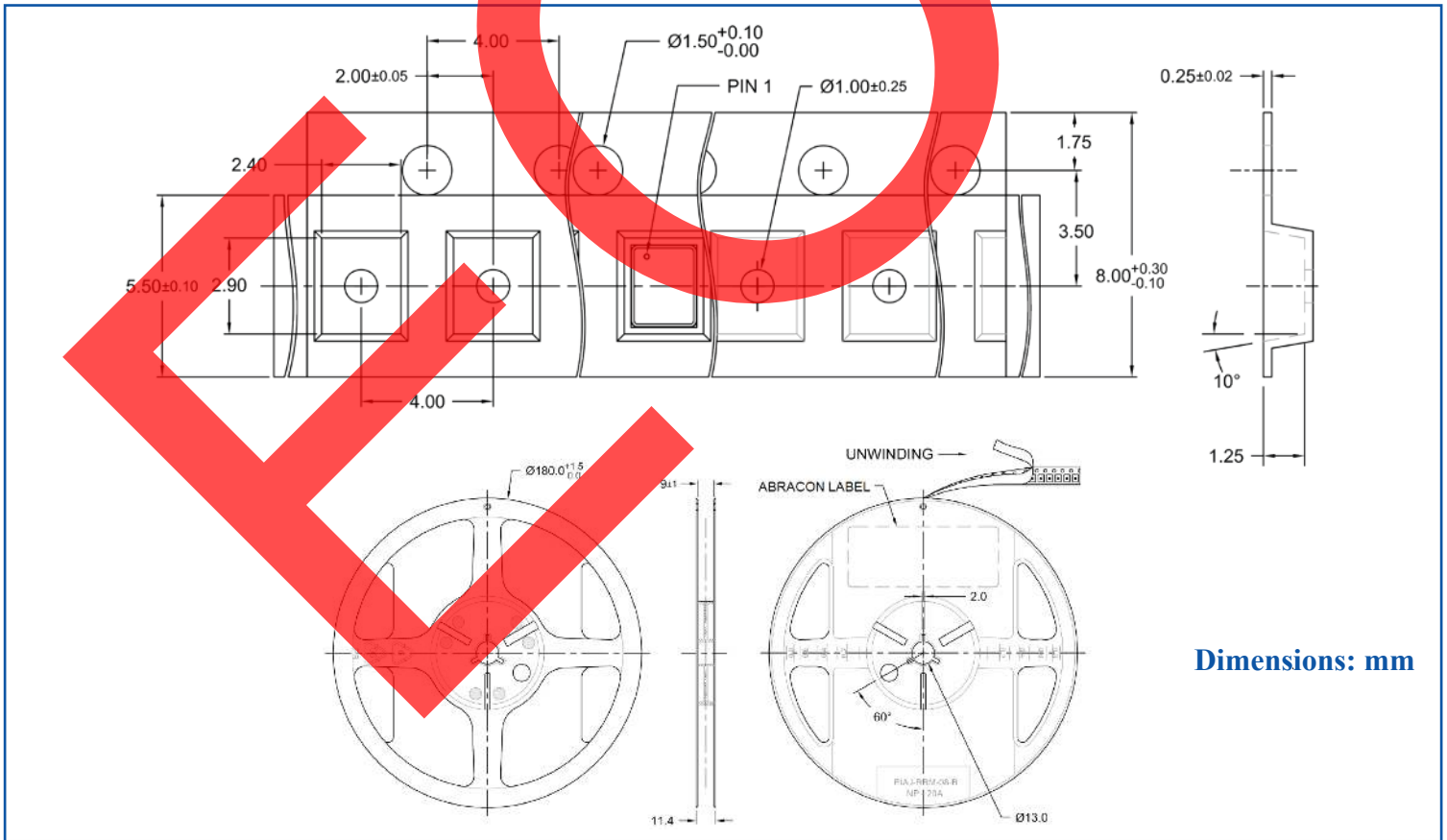

Dimensions: mm

ATTENTION: Abracon Corporation's products are COTS – Commercial-Off-The-Shelf products; suitable for Commercial, Industrial and, where designated, Automotive Applications. Abracon's products are not specifically designed for Military, Aviation, Aerospace, Life-dependant Medical applications or any application requiring high reliability where component failure could result in loss of life and/or property. For applications requiring high reliability and/or presenting an extreme operating environment, written consent and authorization from Abracon Corporation is required. Please contact Abracon Corporation for more information.

ABRACON IS
ISO9001:2008
CERTIFIED

 **ABRACON** LLC
The Power of Linking Together

2 Faraday, Suite# B | Irvine | CA 92618 Revised: 09.21.15
Ph. 949.546.8000 | Fax. 949.546.8001
Visit www.abracon.com for Terms and Conditions of Sale