

# RT8497 Evaluate Report for non-isolation floating buck LED driver (bulb application)

---

*February 2016*

**RICHTEK**  
your power partner.

# RT8497 Brief Introduction

---

RT8497 is a active power factor correction controller, specifically designed for using as a constant current LED driver.

Supporting : Non-isolation(Buck mode)

**Applications** ➔ **AC/DC LED lighting driver**



PAR Lamp



E27 Bulb



T5/T8 Tube

# RT8497 Features

---

## High Efficiency BCM LED Driver Controller for High Power Factor Offline Applications

- Built-in Power MOSFET
- High Power Factor and THDi
- Constant LED current with Highly Precision Current regulation
- Extremely Low Quiescent Current Consumption.
- True Low System BOM Cost
- Unique Programmable AND pin for ZVS Setting to Achieve Best power Efficiency
- Universal Input Voltage Range with Off-Line Topology

# RT8497 Advantage

---

- Tight LED Current Regulation
- Low BOM Cost
- Protection:
  - a. Built-in Over Thermal Protection
  - b. Built-in Over Voltage Protection
  - c. Output LED String Open protection
  - d. Output LED String Short protection
  - e. Output LED Over Current protection

# Circuit

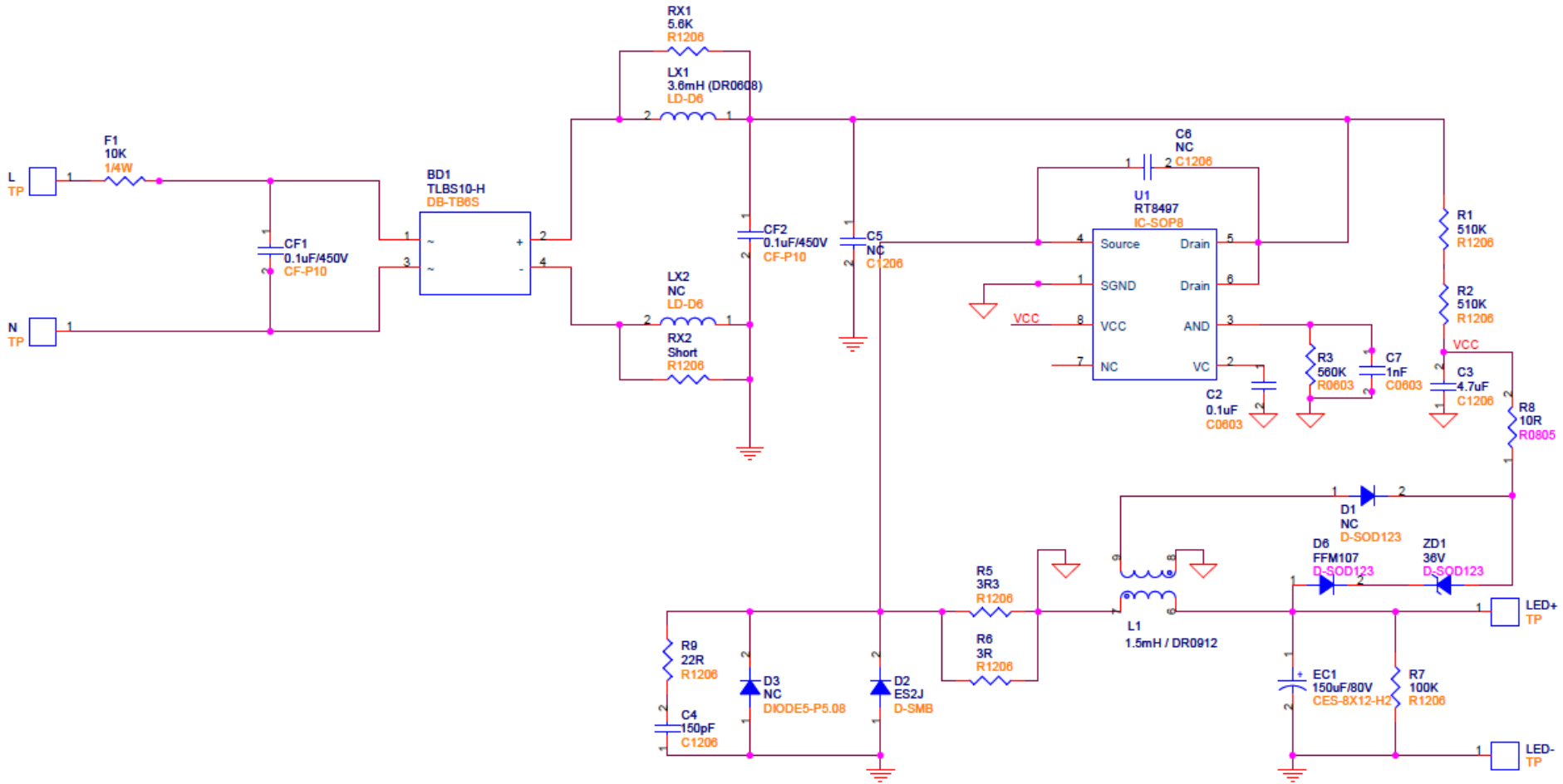

# Electrical Performance

Load: LED Series

Line filter on

Frequency	Vac [V]	Pin [watt]	Vout[V]	Iout[mA]	Pout [watt]	Total Eff. [%]	PF Value	THD [%]
60Hz	90	10.630	61.40	149.8	9.198	86.53%	0.912	43.71
60Hz	100	10.510	61.39	150.5	9.239	87.91%	0.935	36.37
60Hz	110	10.460	61.39	151.1	9.276	88.68%	0.950	30.97
60Hz	120	10.430	61.37	151.7	9.310	89.26%	0.959	26.78
60Hz	132	10.410	61.37	152.1	9.334	89.67%	0.966	22.93
50Hz	195	10.530	61.37	153.6	9.426	89.52%	0.963	13.83
50Hz	220	10.600	61.35	154	9.448	89.13%	0.949	13.13
50Hz	230	10.620	61.34	154	9.446	88.95%	0.942	13.19
50Hz	240	10.660	61.33	154.1	9.451	88.66%	0.935	13.36
50Hz	264	10.740	61.32	154.2	9.456	88.04%	0.913	14.16

current regulation = 2.85%

△ Efficiency = 3.14%

Maximum PFC = 0.966

Minimum PFC = 0.912

# Efficiency

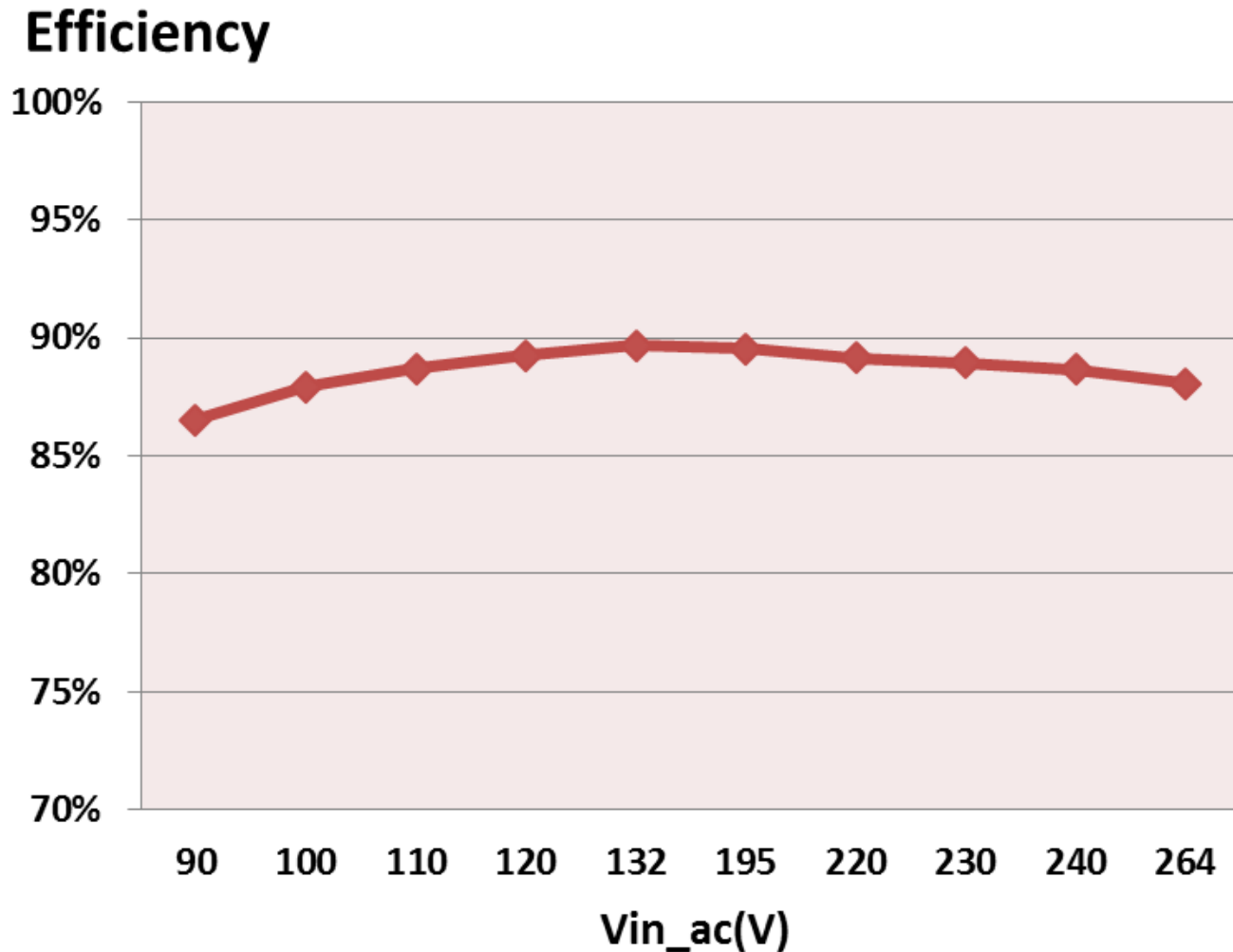

# Power Factor

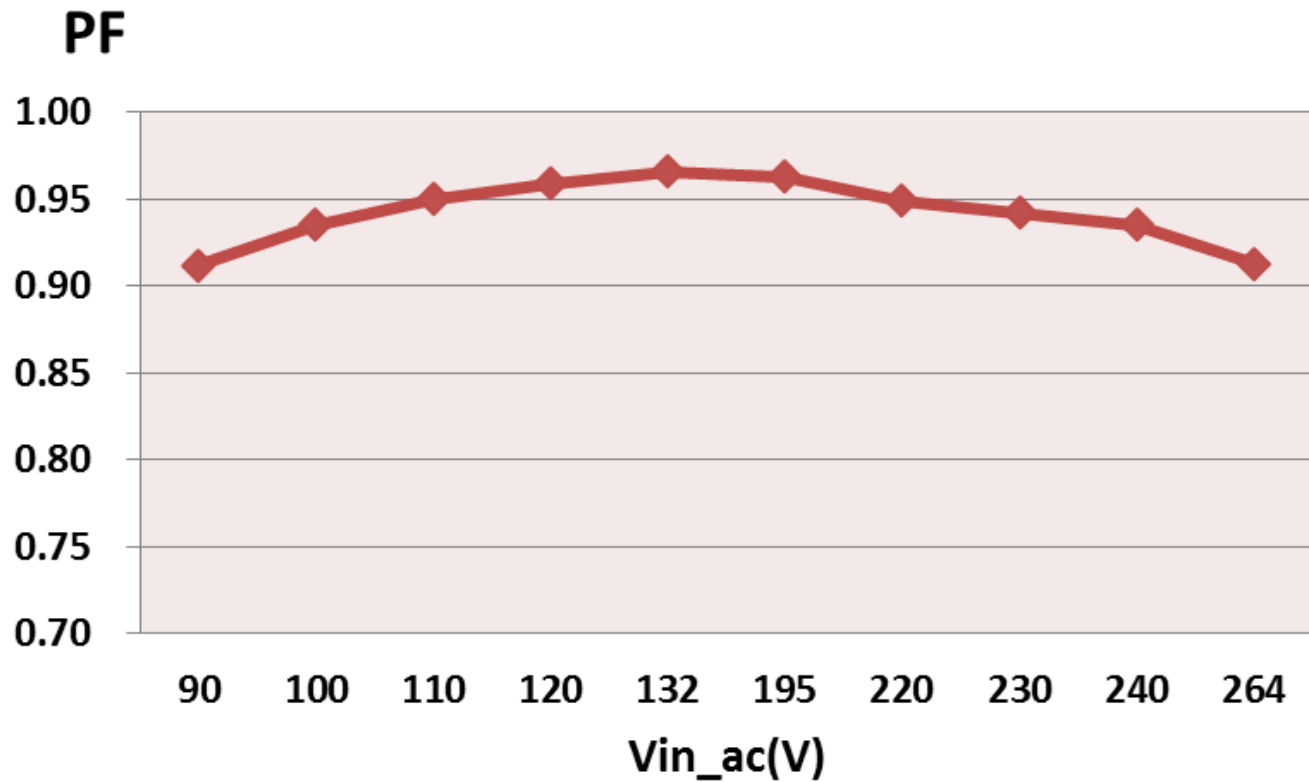



# Current Regulation

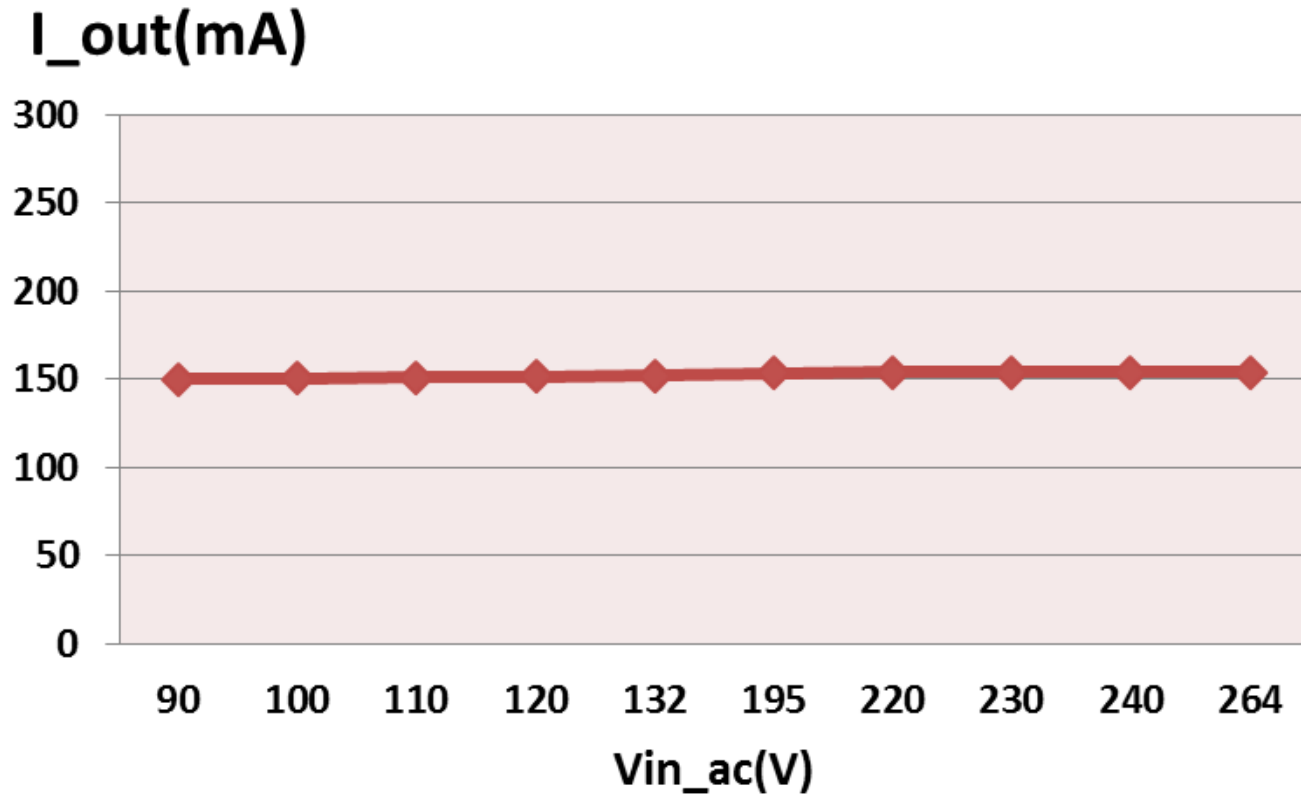

# Temperature

(Test Condition : Burn-in 30min. @ Ta = 25 °C)

90Vac/60Hz input

F1	10 ohm, 1/4W	60.1
LX1	3.6mH, DR0608	67.8
BD1	LBS10-H	52.9
U1	RT8497, SOP8	74.3
D2	ES2J (RC=22R,150pF)	49.4
L1 (wire)	EE-13, 1.2mH	50.7
L1 (core)		50.8
R5, R6	3.0//3.3 ohm, 1206	55.8
C3	4.7uF/50V, 1206	58.1
D6	FR107	51.9
ZD1	36V , SOD123	57.4
EC1	E-cap, 150uF/80V	41.5

264Vac/50Hz input

F1	10 ohm, 1/4W	36.9
LX1	3.6mH, DR0608	49.3
BD1	LBS10-H	41.8
U1	RT8497, SOP8	72.7
D2	ES2J (RC=22R,150pF)	54.1
L1 (wire)	EE-13, 1.2mH	56.4
L1 (core)		53.3
R5, R6	3.0//3.3 ohm, 1206	57.8
C3	4.7uF/50V, 1206	55.3
D6	FR107	51.6
ZD1	36V , SOD123	57
EC1	E-cap, 150uF/80V	44.8

# PCB Layout

TOP Layer

BOTTOM Layer

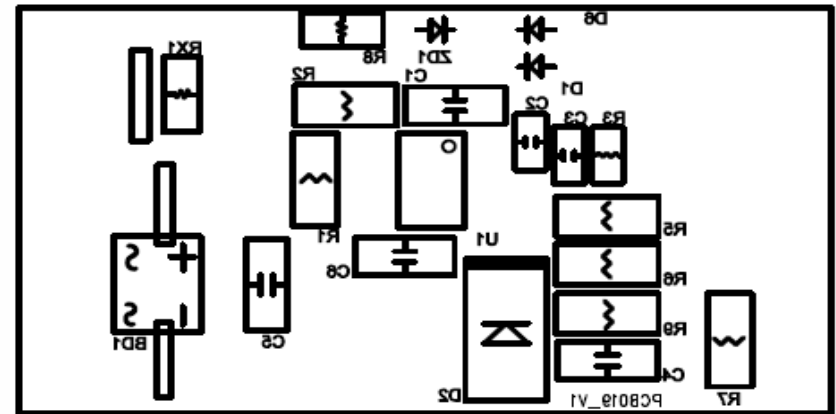
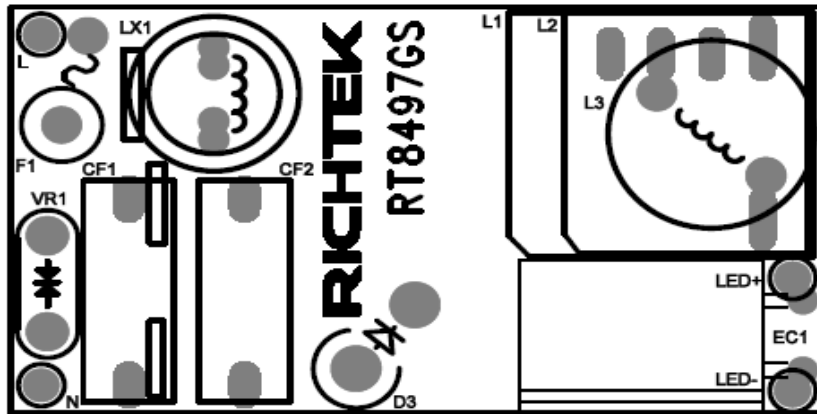

PCB No : PCB019\_V1

# Demo Board Photo

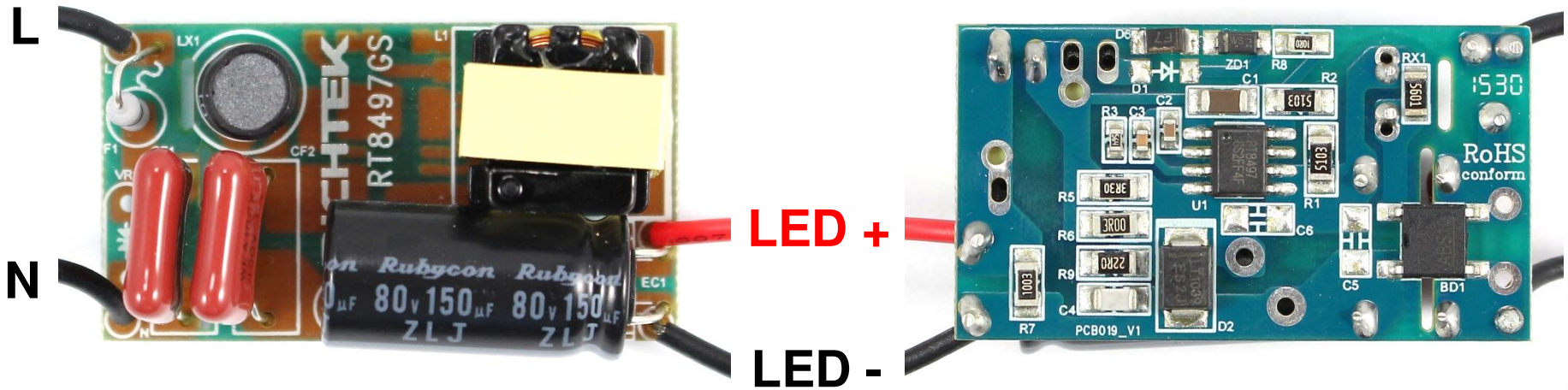

Length	Width	Height
40mm	60mm	20mm

# BOM

Item	Location	Value	Type
1	BD1	LBS10-H	TDI (Macro DIP)
2	C2	0.1uF/50V, X7R	C0603
3	C3	4.7uF/50V	C1206
4	C4	150pF/1kV	C1206
5	C7	1nF/50V, X7R	C0603
6	CF2	Film cap, 0.1uF/450V	CF-P10
7	D2	ES2J (600V, 2A)	SMB
8	D6	FFM107-M	SOD-123
9	EC1	E-cap, ZLH, 150uF/80V	10*20mm
10	F1	10 ohm, 1/4W	DIP, 1/4W
11	L1	EE-13, 1.2mH	EE-13
12	LX1	Drum core, 3.6mH	DR0608

# BOM

Item	Location	Value	Type
13	R1,R2	510k ohm	R1206
14	R3	560k ohm	R0603
15	R5	3.3 ohm	R1206
16	R6	3.0 ohm	R1206
17	R7	100k ohm	R1206
18	R8	10 ohm	R0805
19	R9	22 ohm	R1206
20	RX1	5.6k ohm	1206
21	RX2	0 ohm (Jumper)	1206
22	U1	RT8497	SOP-8
23	VR1 (CF1)	Film cap, 0.1uF/450V	CF-P10
24	ZD1	Zener, BZT55C36	SOD-123F

# Transformer

Vender :

CORE SIZE: **EE-13** Material: **PC40**

Bobbin/PINs: **Vertical / 10 pins**

Primary inductor: (**+/-10%**) **1.2mH**

Test condition: **10KHz / 1V**

Varnish : **Yes**

Mechanical Assembly: **Bottom View**

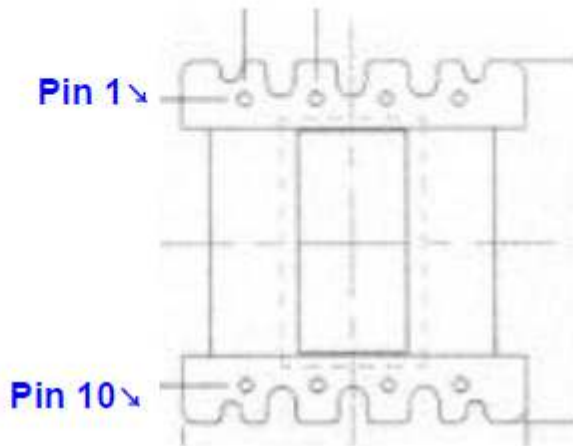
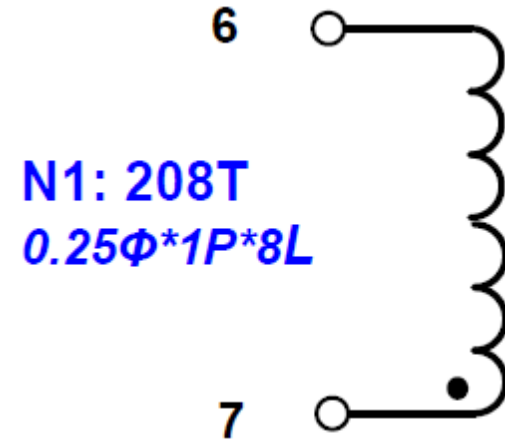

Structure:(繞線結構)

Winding No. (組別)	PIN (腳位)	Wire & Wire & Copper (線徑 x 股數 x 層數)	Turns (圈數)	Winding Type (繞線方式)	Tape Layer (膠帶層次)
<i>Bobbin</i>					
N1	7 → 6	0.25mm x 1P x 8L	208Ts	密繞	1L
<i>Core – EE-13/6/6</i>				1.2mH	

\*. 繞製腳位依 PCB 畫板再調整.

# Power Component Voltage Stress

**Test condition: 264Vac/50Hz input , 60V/150mA output**

Stead state			
Location	Max rating (V)	Measure	De-rating
U1 (Vds)	500	404	80.8%
D7	600	400	66.7%

Transient State			
Location	Max rating (V)	Measure	De-rating
U1 (Vds)	500	397	79.4%
D7	600	404	67.3%



# Start up waveform

**Vac\_in = 90V**

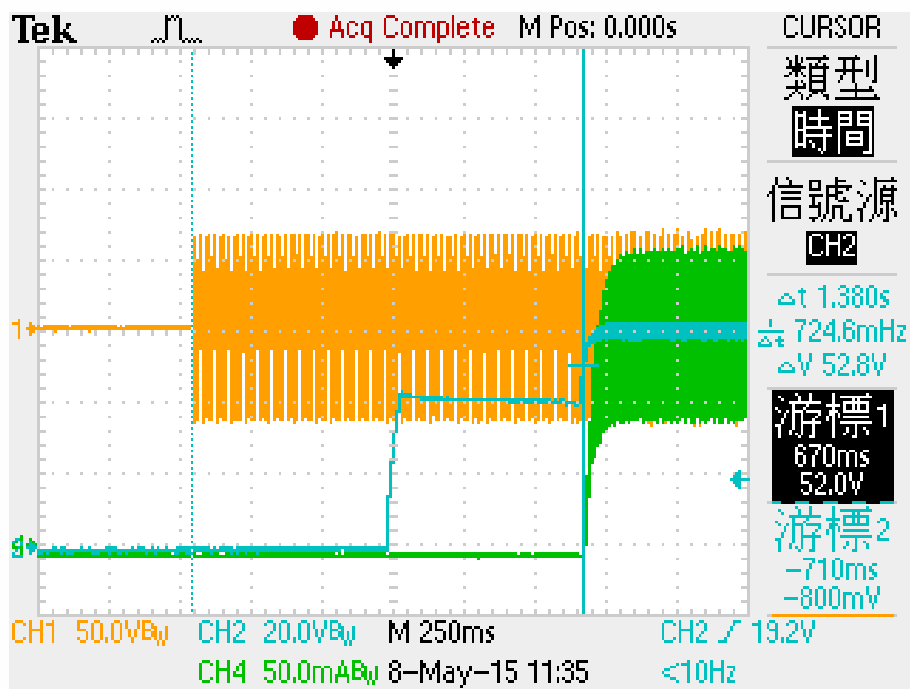

**T\_start up = 1380ms**

**Vac\_in = 264V**

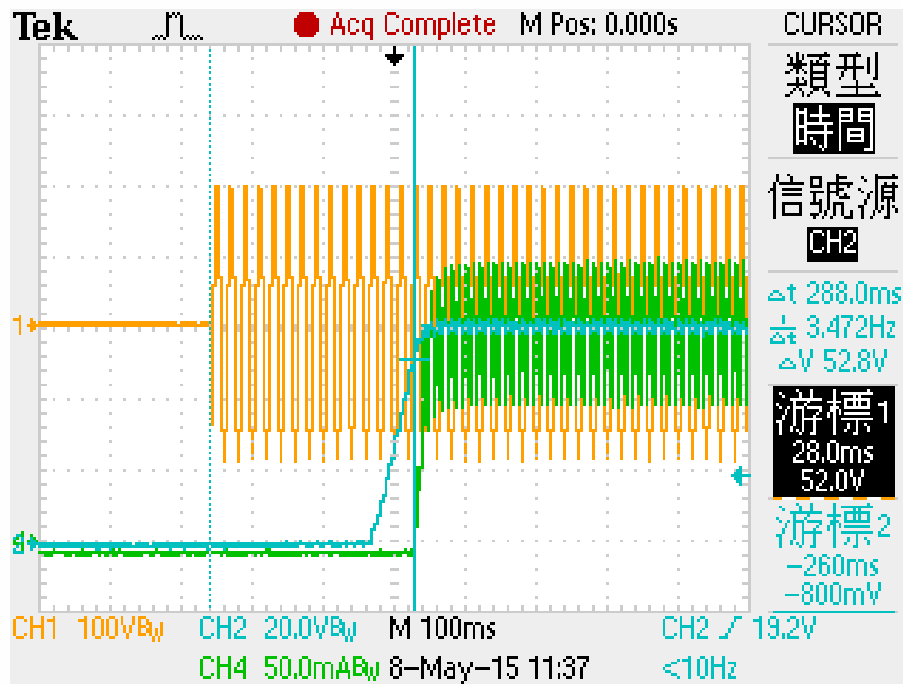

**T\_start up = 288ms**

# Harmonic(IEC61000-3-2)

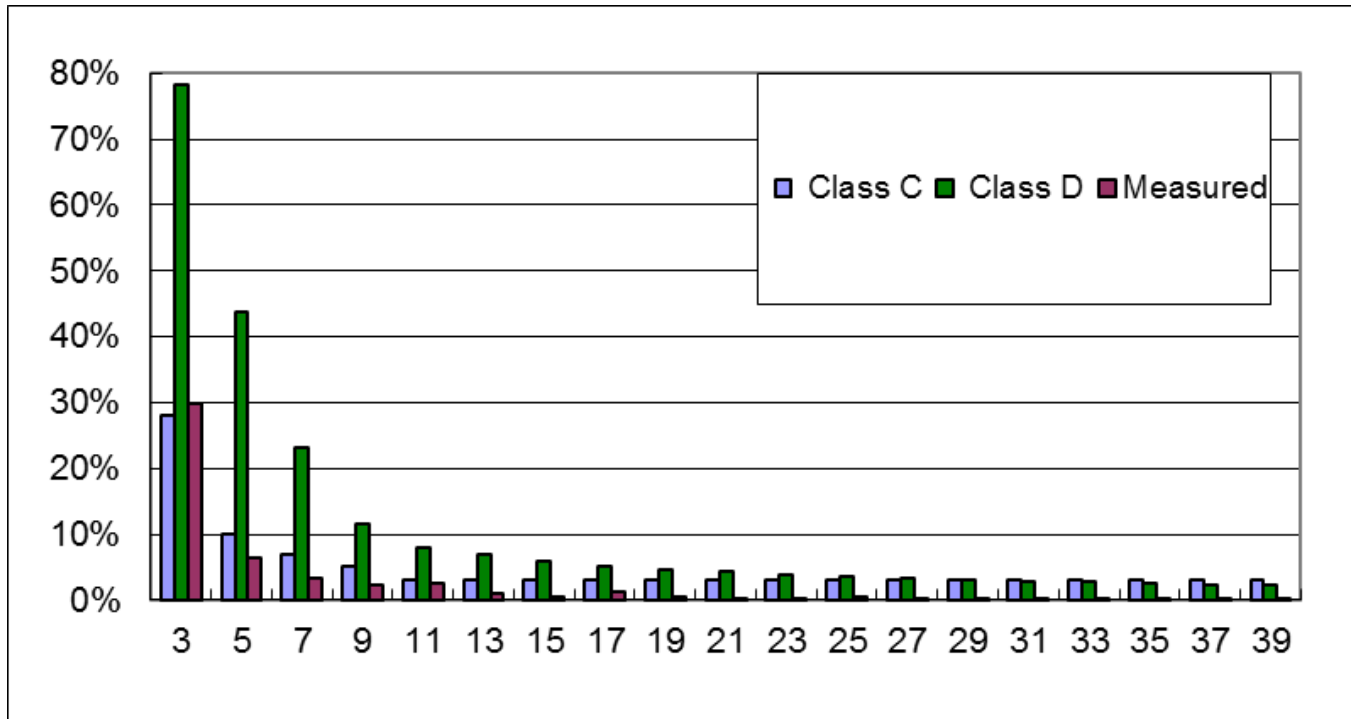

**110Vac input**  
**Class C : TBD**  
**Class D : Pass**

# Harmonic(IEC61000-3-2)

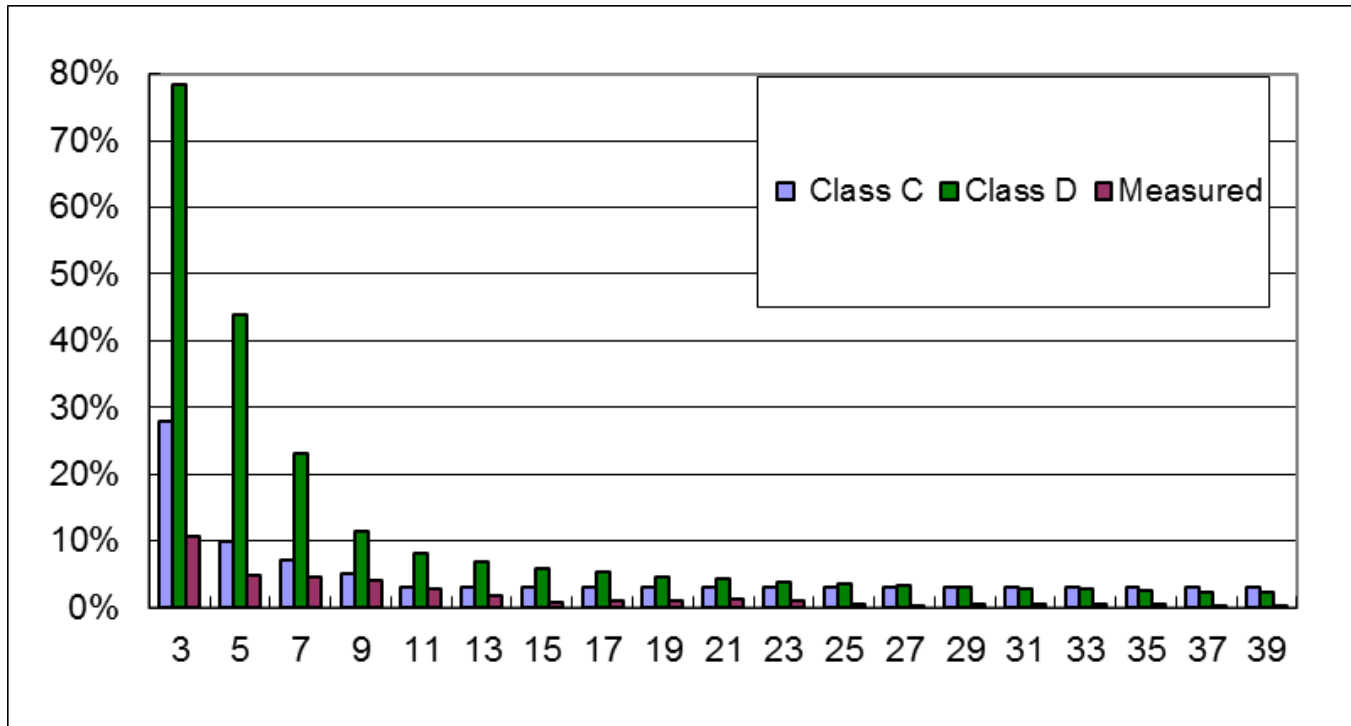

**230Vac input**  
**Class C : Pass**  
**Class D : Pass**

# EMI-Conduction(1)

110Vac/60Hz-L → Pass  
(9kHz~150kHz)

110Vac/60Hz-L → Pass  
(150kHz~30MHz)



SPORTON INTERNATIONAL INC.  
No.8,Lane 724,Bo Ai Street,Zhubei City,Hsin Chu H  
TAIWAN R.O.C  
tel:+886-3-6569065 fax:+886-3-6569085  
http://www.sporton.com.tw



SPORTON INTERNATIONAL INC.  
No.8,Lane 724,Bo Ai Street,Zhubei City,Hsin Chu H  
TAIWAN R.O.C  
tel:+886-3-6569065 fax:+886-3-6569085  
http://www.sporton.com.tw

Data: 19 File: D:\COND test data\Test data\2015 測試資料\立錡\RT8497.EM6 (20) Date: 2015-06-11 Time: 10:48:49

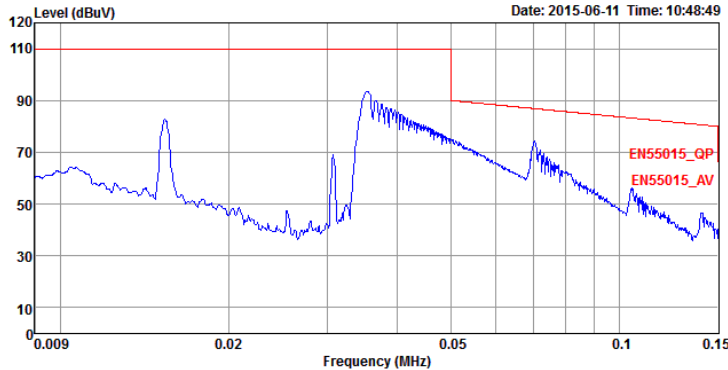

Site : C002-CB  
Condition: EN55015\_QP LISN+PULSE 201502 LINE  
Engineer : Da  
EUT : RT8497  
Power : 110V  
Mode :  
Memo : 60V/150mA, internal bulb

Data: 20 File: D:\COND test data\Test data\2015 測試資料\立錡\RT8497.EM6 (20) Date: 2015-06-11 Time: 10:49:22

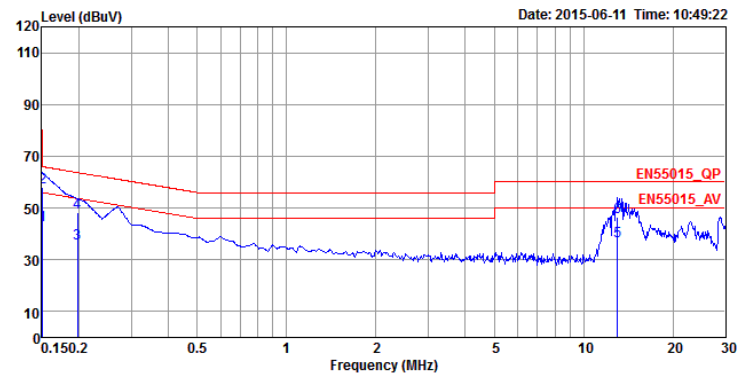

Site : C002-CB  
Condition: EN55015\_QP LISN+PULSE 201502 LINE  
Engineer : Da  
EUT : RT8497  
Power : 110V  
Mode :  
Memo : 60V/150mA, internal bulb

	Freq	Level	Over	Limit	Read	LISN	Cable		Remark
	MHz	dBuV	dB	dBuV	dBuV	dB	Loss	Pol/Phase	
1	0.1508	43.44	-12.52	55.96	33.27	10.00	0.17	LINE	Average
2	0.1508	58.22	-7.74	65.96	48.05	10.00	0.17	LINE	QP
3	0.1976	36.14	-17.57	53.71	25.94	10.01	0.19	LINE	Average
4	0.1976	48.33	-15.38	63.71	38.13	10.01	0.19	LINE	QP
5	12.9885	37.01	-12.99	50.00	26.32	10.28	0.41	LINE	Average
6	12.9885	46.51	-13.49	60.00	35.82	10.28	0.41	LINE	QP

# EMI-Conduction(2)

110Vac/60Hz-N → Pass  
(9kHz~150kHz)

110Vac/60Hz-N → Pass  
(150kHz~30MHz)



SPORTON INTERNATIONAL INC.  
No.8,Lane 724,Bo Ai Street,Zhubei City,Hsin Chu H  
TAIWAN R.O.C  
tel:+886-3-6569065 fax:+886-3-6569085  
http://www.sporton.com.tw

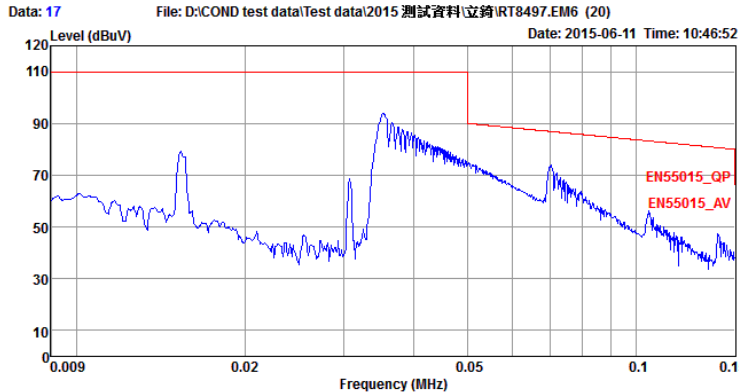

Site : C002-CB  
Condition: EN55015\_QP LISN+PULSE 201502 NEUTRAL  
Engineer : Da  
EUT : RT8497  
Power : 110V  
Mode :  
Memo : 60V/150mA, internal bulb



SPORTON INTERNATIONAL INC.  
No.8,Lane 724,Bo Ai Street,Zhubei City,Hsin Chu H  
TAIWAN R.O.C  
tel:+886-3-6569065 fax:+886-3-6569085  
http://www.sporton.com.tw

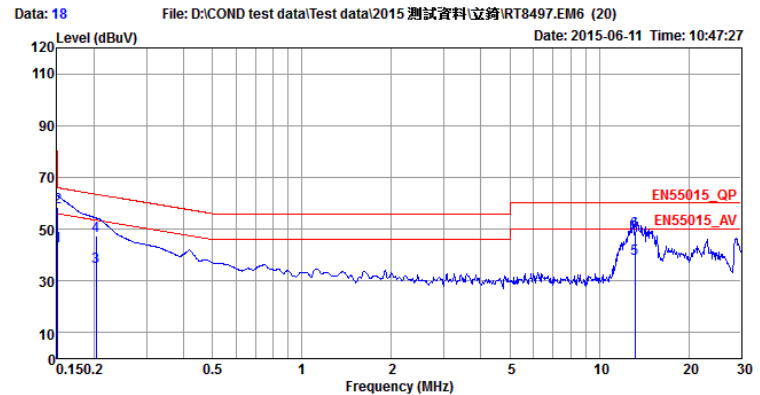

Site : C002-CB  
Condition: EN55015\_QP LISN+PULSE 201502 NEUTRAL  
Engineer : Da  
EUT : RT8497  
Power : 110V  
Mode :  
Memo : 60V/150mA, internal bulb

	Freq	Level	Over	Limit	Read	LISN	Cable		
	MHz	dBuV	Limit	Line	Level	Factor	Loss	Pol/Phase	Remark
			dB	dBuV	dBuV	dB	dB		
1	0.1508	43.56	-12.40	55.96	33.39	10.00	0.17	NEUTRAL	Average
2	0.1508	58.32	-7.64	65.96	48.15	10.00	0.17	NEUTRAL	QP
3	0.2029	35.52	-17.97	53.49	25.32	10.01	0.19	NEUTRAL	Average
4	0.2029	47.24	-16.25	63.49	37.04	10.01	0.19	NEUTRAL	QP
5	13.1966	38.56	-11.44	50.00	27.86	10.29	0.41	NEUTRAL	Average
6	13.1966	49.33	-10.67	60.00	38.63	10.29	0.41	NEUTRAL	QP

# EMI-Conduction(3)

230Vac/60Hz-L → Pass  
(9kHz~150kHz)

230Vac/60Hz-L → Pass  
(150kHz~30MHz)



SPORTON INTERNATIONAL INC.  
No.8,Lane 724,Bo Ai Street,Zhubei City,Hsin Chu H  
TAIWAN R.O.C  
tel:+886-3-6569065 fax:+886-3-6569085  
http://www.sporton.com.tw



SPORTON INTERNATIONAL INC.  
No.8,Lane 724,Bo Ai Street,Zhubei City,Hsin Chu H  
TAIWAN R.O.C  
tel:+886-3-6569065 fax:+886-3-6569085  
http://www.sporton.com.tw

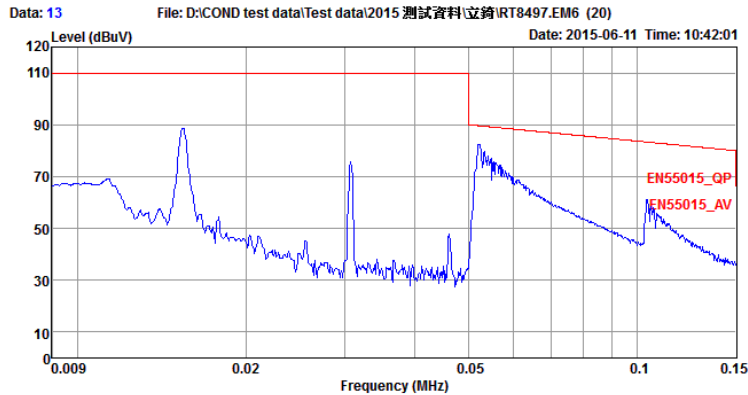

Site : C002-CB  
Condition: EN55015\_QP LISN+PULSE 201502 LINE  
Engineer : Da  
EUT : RT8497  
Power : 230V  
Mode :  
Memo : 60V/150mA, internal bulb

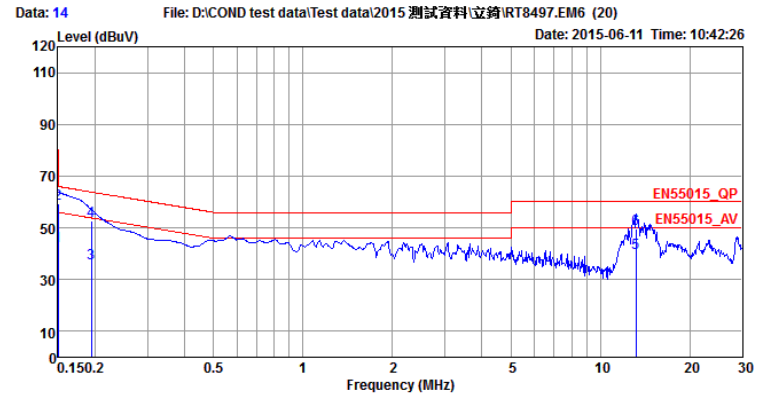

Site : C002-CB  
Condition: EN55015\_QP LISN+PULSE 201502 LINE  
Engineer : Da  
EUT : RT8497  
Power : 230V  
Mode :  
Memo : 60V/150mA, internal bulb

	Freq	Level	Over	Limit	Read	LISN	Cable		
	MHz	dBuV	Limit	Line	Level	Factor	Loss	Pol/Phase	Remark
			dB	dBuV	dBuV	dB	dB		
1	0.1505	42.98	-12.99	55.97	32.81	10.00	0.17	LINE	Average
2	0.1505	59.22	-6.75	65.97	49.05	10.00	0.17	LINE	QP
3	0.1945	36.50	-17.34	53.84	26.30	10.01	0.19	LINE	Average
4	0.1945	52.87	-10.97	63.84	42.67	10.01	0.19	LINE	QP
5	13.2068	40.14	-9.86	50.00	29.44	10.29	0.41	LINE	Average
6	13.2068	49.75	-10.25	60.00	39.05	10.29	0.41	LINE	QP

# EMI-Conduction(4)

230Vac/60Hz-N → Pass  
(9kHz~150kHz)

230Vac/60Hz-N → Pass  
(150kHz~30MHz)



SPORTON INTERNATIONAL INC.  
No.8, Lane 724, Bo Ai Street, Zhubei City, Hsin Chu H  
TAIWAN R.O.C  
tel:+886-3-6569065 fax:+886-3-6569085  
http://www.sporton.com.tw

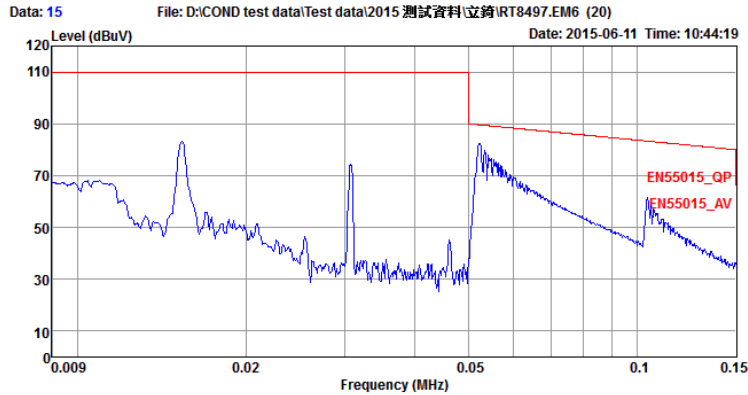

Site : C002-CB  
Condition: EN55015\_QP LISN+PULSE 201502 NEUTRAL  
Engineer : Da  
EUT : RT8497  
Power : 230V  
Mode :  
Memo : 60V/150mA, internal bulb



SPORTON INTERNATIONAL INC.  
No.8, Lane 724, Bo Ai Street, Zhubei City, Hsin Chu H  
TAIWAN R.O.C  
tel:+886-3-6569065 fax:+886-3-6569085  
http://www.sporton.com.tw

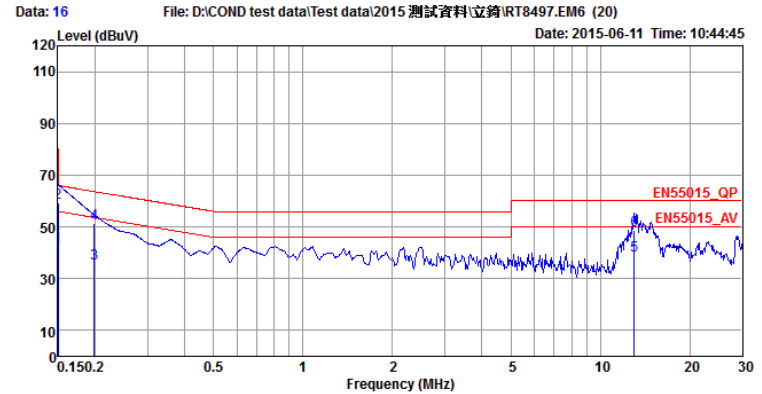

Site : C002-CB  
Condition: EN55015\_QP LISN+PULSE 201502 NEUTRAL  
Engineer : Da  
EUT : RT8497  
Power : 230V  
Mode :  
Memo : 60V/150mA, internal bulb

	Freq	Level	Over	Limit	Read	LISN	Cable	Pol/Phase	Remark
	MHz	dBuV	dB	dBuV	dBuV	dB	dB		
1	0.1504	42.67	-13.31	55.98	32.50	10.00	0.17	NEUTRAL	Average
2	0.1504	59.14	-6.84	65.98	48.97	10.00	0.17	NEUTRAL	QP
3	0.1986	35.87	-17.80	53.67	25.67	10.01	0.19	NEUTRAL	Average
4	0.1986	51.20	-12.47	63.67	41.00	10.01	0.19	NEUTRAL	QP
5	12.9885	39.14	-10.86	50.00	28.45	10.28	0.41	NEUTRAL	Average
6	12.9885	48.69	-11.31	60.00	38.00	10.28	0.41	NEUTRAL	QP

# EMI-Radiation(1)

## 110Vac/60Hz-V → Pass

## 110Vac/60Hz-H → Pass



No. 8 Lane 724, Bo Ai Street, Zhubei City,  
Hsin Chu Hsien 302, Taiwan, R.O.C.  
TEL:03-656-9065  
FAX:03-656-9085



No. 8 Lane 724, Bo Ai Street, Zhubei City,  
Hsin Chu Hsien 302, Taiwan, R.O.C.  
TEL:03-656-9065  
FAX:03-656-9085

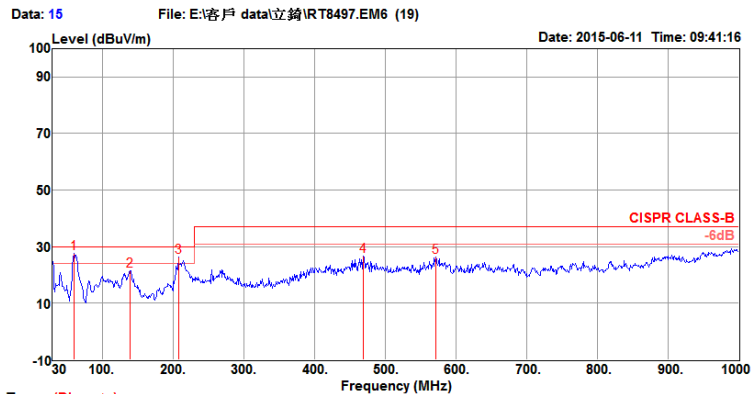

Trace: (Discrete)  
Condition: CISPR CLASS-B 10m BILOG ANT 20141111 VERTICAL  
: RBW:100.000KHz VBW:300.000KHz SWT:0.500sec  
Engineer :  
Eut : RT8487  
Mode : Normal  
Power : AC 110V/60Hz  
Memo 5-1 : 60V/150mA, internal bulb  
Memo 5-2 :

	Freq	Level	Limit	Over	Read	CableAntenna	Preamp	A/Pos	T/Pos	Remark	Pol/Phase
	MHz	dBuV/m	Line	Limit	Level	Loss	Factor	cm	deg		
1	60.07	27.75	30.00	-2.25	52.38	0.77	6.90	125	271	Peak	VERTICAL
2	138.64	21.42	30.00	-8.58	44.57	1.07	12.16	100	172	Peak	VERTICAL
3	207.51	26.34	30.00	-3.66	46.91	1.28	10.69	200	99	Peak	VERTICAL
4	468.44	26.53	37.00	-10.47	46.30	1.85	17.36	100	99	Peak	VERTICAL
5	571.26	26.26	37.00	-10.74	42.51	2.01	18.87	150	225	Peak	VERTICAL

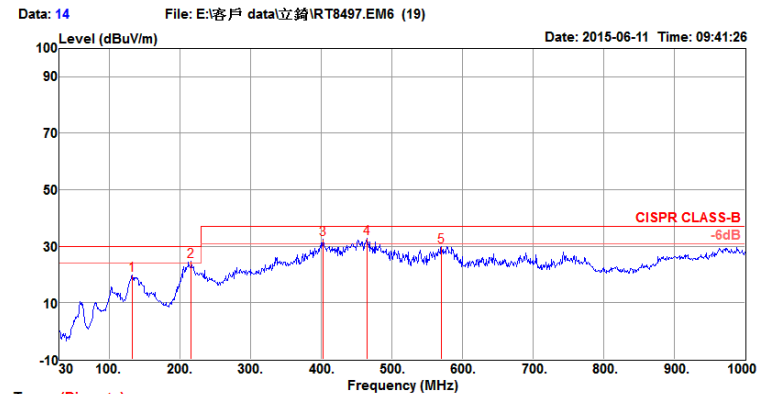

Trace: (Discrete)  
Condition: CISPR CLASS-B 10m BILOG ANT 20141111 HORIZONTAL  
: RBW:100.000KHz VBW:300.000KHz SWT:0.500sec  
Engineer :  
Eut : RT8487  
Mode : Normal  
Power : AC 110V/60Hz  
Memo 5-1 : 60V/150mA, internal bulb  
Memo 5-2 :

	Freq	Level	Limit	Over	Read	CableAntenna	Preamp	A/Pos	T/Pos	Remark	Pol/Phase
	MHz	dBuV/m	Line	Limit	Level	Loss	Factor	cm	deg		
1	132.82	19.83	30.00	-10.17	48.55	1.06	12.52	200	193	Peak	HORIZONTAL
2	216.24	24.69	30.00	-5.31	52.55	1.30	10.74	125	190	Peak	HORIZONTAL
3	402.48	32.62	37.00	-4.38	51.76	1.73	16.53	100	360	Peak	HORIZONTAL
4	464.56	32.72	37.00	-4.28	49.75	1.84	17.30	200	226	Peak	HORIZONTAL
5	570.29	30.01	37.00	-6.99	46.27	2.01	18.86	150	214	Peak	HORIZONTAL



# EMI-Radiation(2)

## 230Vac/50Hz-V → Pass

## 230Vac/50Hz-H → Pass



No. 8 Lane 724, Bo Ai Street, Zhubei City,  
Hsin Chu Hsien 302, Taiwan, R.O.C.  
TEL:03-656-9065  
FAX:03-656-9085



No. 8 Lane 724, Bo Ai Street, Zhubei City,  
Hsin Chu Hsien 302, Taiwan, R.O.C.  
TEL:03-656-9065  
FAX:03-656-9085

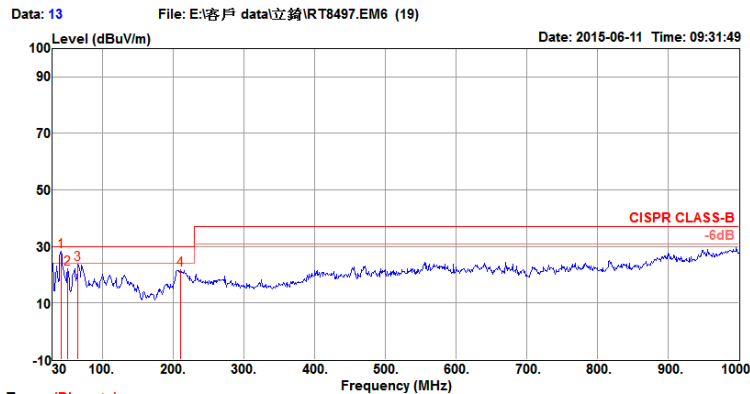

Trace: (Discrete)  
Condition: CISPR CLASS-B 10m BILOG ANT 20141111 VERTICAL  
: RBW:100.000KHz VBW:300.000KHz SWT:0.500sec  
Engineer :  
Eut : RT8487  
Mode : Normal  
Power : AC 220V/50Hz  
Memo 5-1 : 60V/150mA, internal bulb  
Memo 5-2 :

	Freq	Level	Limit	Over	Read	CableAntenna	Preamp	A/Pos	T/Pos	Remark	Pol/Phase
	MHz	dBuV/m	dBuV/m	dB	dBuV	Loss	Factor	Factor	cm	deg	
1	41.64	28.19	30.00	-1.81	53.64	0.67	12.98	32.28	100	182	Peak VERTICAL
2	51.34	22.11	30.00	-7.89	48.19	0.73	8.79	32.32	100	320	Peak VERTICAL
3	65.89	23.74	30.00	-6.26	50.03	0.80	6.84	32.32	200	140	Peak VERTICAL
4	210.42	21.66	30.00	-8.34	41.97	1.29	10.80	32.04	125	197	Peak VERTICAL

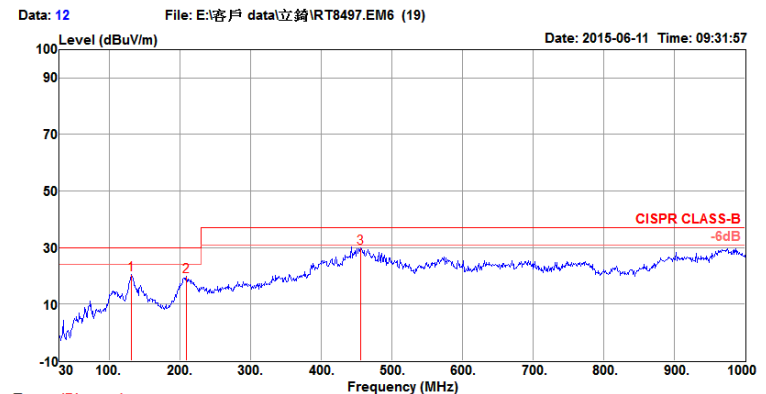

Trace: (Discrete)  
Condition: CISPR CLASS-B 10m BILOG ANT 20141111 HORIZONTAL  
: RBW:100.000KHz VBW:300.000KHz SWT:0.500sec  
Engineer :  
Eut : RT8487  
Mode : Normal  
Power : AC 220V/50Hz  
Memo 5-1 : 60V/150mA, internal bulb  
Memo 5-2 :

	Freq	Level	Limit	Over	Read	CableAntenna	Preamp	A/Pos	T/Pos	Remark	Pol/Phase
	MHz	dBuV/m	dBuV/m	dB	dBuV	Loss	Factor	Factor	cm	deg	
1	130.88	20.66	30.00	-9.34	48.55	1.05	12.64	32.22	200	190	Peak HORIZONTAL
2	209.45	19.83	30.00	-10.17	47.69	1.28	10.76	32.04	125	215	Peak HORIZONTAL
3	455.83	29.92	37.00	-7.08	46.37	1.82	17.18	32.07	100	358	Peak HORIZONTAL

**RICHTEK**  
your power partner.

thank you.