

## 1. Mechanical Dimensions:

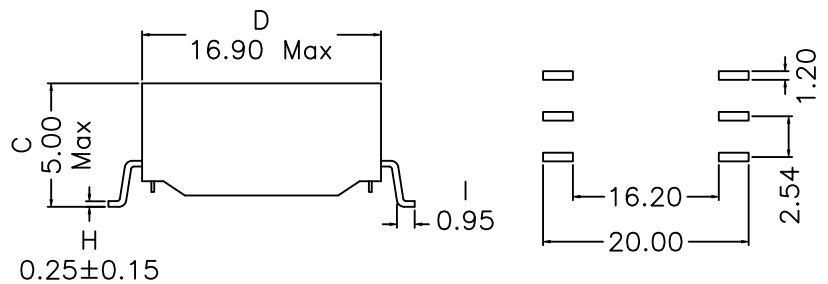

## 2. Schematic:

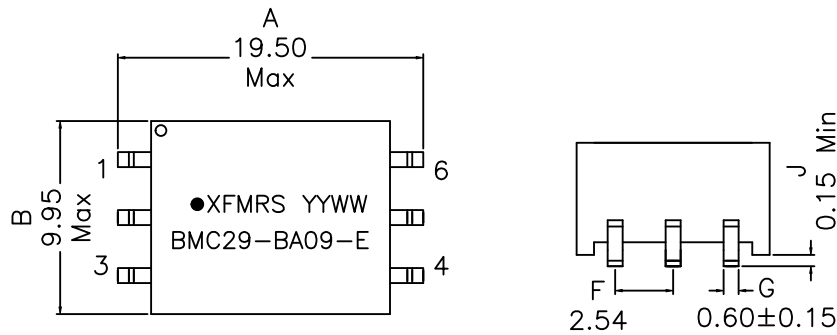
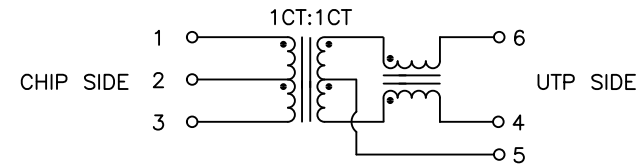

## 3. Electrical Specifications: @25°C

UTP Impedance: 100 OHMS  
 Turns Ratio: (CHIP : UTP)=1CT:1CT±2%  
 Isolation Voltage: 2900Vac, CHIP SIDE to UTP SIDE  
 UTP Side OCL: 350uH Min @100KHz 0.1V, 8mAdc  
 UTP Side Q: 5 Min @100KHz 0.1V,  
 Rise Time (10-90%): 4.0ns Typical  
 Insertion Loss (1-50MHz): -1.0dB Maximum  
 (50-100MHz): -2.0dB Maximum  
 Return Loss: 30MHz 60MHz 80MHz  
 -20dB -14dB -9dB Typ  
 CMRR: 30MHz 50MHz 100MHz  
 -42dB -37dB -33dB Typ

### Notes:

1. Solderability: Leads shall meet MIL-STD-202G, Method 208H for solderability.
2. Flammability: UL94V-0
3. ASTM oxygen index: > 28%
4. Insulation System: Class F 155°C. UL file E151556
5. Operating Temperature Range: -40°C to +85°C
6. Storage Temperature Range: -55°C to +125°C
7. Aqueous wash compatible
8. SMD Lead Coplanarity: ±0.004"(0.102mm)
9. Electrical and mechanical specifications 100% tested
10. RoHS Compliant Component
11. Recommended IR Reflow peak temp of 250°C Max.

DOC. REV: A/2

<b>XFMR5</b> <sup>®</sup> www.XFMR5.com	Title: <b>TRANSFORMER</b>		
	UNLESS OTHERWISE SPECIFIED	P/N: XFBMC29-BA09-E	REV. A
TOLERANCES: .xx ±0.25	DWN.	Yu	May-02-20
Dimensions in MM	CHK.	YK Liao	May-02-20
SHEET 1 OF 1	APP.	BW	May-02-20

CONCEPT

**GENERAL INFORMATION**

Part Number:	95-BMC0-29-XH
Part Description:	TRANSFORMER
Weight (lbs.):	0.00210 lbs.approx
T&R Notes:	1) PROCESS IN ACCORDANCE WITH EIA-461-2 STANDARDS * TAPE LEADER DIMENSION 15.30" MIN. * TAPE TRAILER DIMENSION 6.30" MIN. 2) PARTS SHOULD BE PACKAGED IN ACCORDANCE WITH ESD GUIDELINES IN EIA-541. 3) REEL LABEL: 'A' * PART NUMBER * QUANTITY * DATE CODE

**SUPPLIER INFORMATION**

Company Name:	XFMRs
Address Line 1:	UNIT G-J, 3/F, BLK 1, GOLDEN DRAGON IND CTR
State / ZIP:	152-160 TAI LIN PAI ROAD
Country:	HONG KONG, CHINA
Program Manager:	Kitty Lai
Contact E-mail:	<a href="mailto:klai@xfmrs.com.hk">klai@xfmrs.com.hk</a>
Contact Phone:	852 2423 1689

**PRIMARY PACKAGING**

Packaging Type:	PST&R			
Dimensions(cm):	L 33.0	W 33.0	H 3.2	
Weight:	1.08 lbs. approx			
QPC (Parts Per Reel)	650 pcs.			
Total Weight w/parts:	2.44 lbs.			
Banding / Shrink / Wrap:	BOPP Wrap			
Other:	N/A			

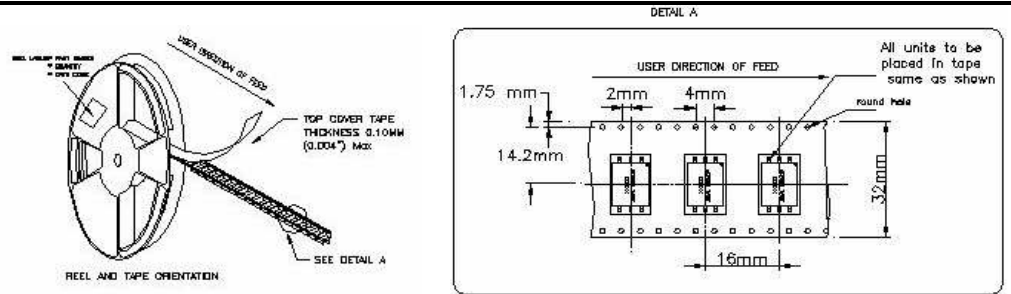

**SECONDARY PACKAGING**

Packaging Type:	Paper Box			
Dimensions(cm):	L 36.5	W 36.5	H 36.0	
Weight:	1.89 lbs.			
Boxes per Unit Load:	5200 pcs.			
Total weight w/Parts (lbs):	21.94 lbs.approx			
Banding / Shrink / Wrap:	BOPP Wrap / PP Banding			
Other:	N/A			

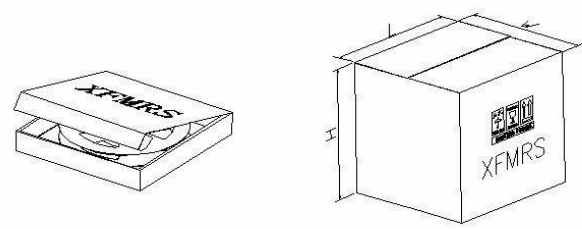

**SHIPPING INFORMATION**

Packaging Type:	PE Pallet			
Unit Load dims(cm):	L 120	W 100	H 161	
Weight:	16.72 lbs.			
Number of box Loads:	24 box.			
Number of Parts:	124800 pcs.			
Load weight total (lbs):	543.18 lbs.approx			
Banding / Shrink / Wrap:	PE Shrink			

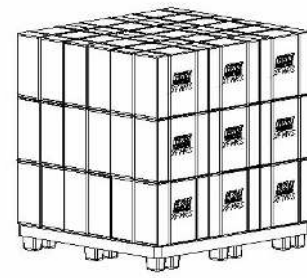

**PACKAGING APPROVAL**

Internal Document Manufacture / Q.A ./ Process Instructions	Drafted	Checked	Approved	Rev	Date
	Kong	Liao		A/1	Aug-07-20

# XFMRs

## Recommended Infrared Reflow Temperature Profile for Select Parts

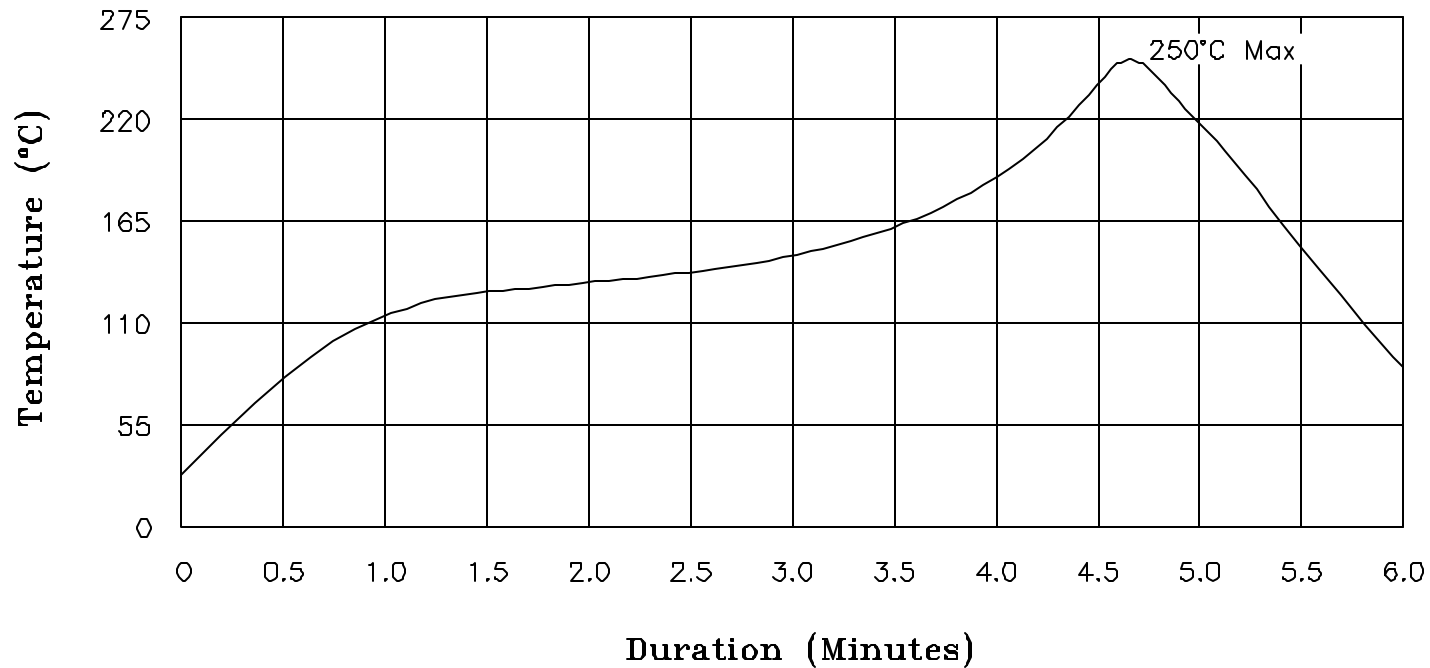

NOTES: Maximum duration at 250°+0/-5° shall be 10-15 seconds.  
 Maximum duration above 217° shall be 50-120 seconds.  
 ALL Temperatures refer to topside of the package, measured on the package body surface.

<b>XFMRs Inc</b> www.XFMRs.com	Title: <b>IR REFLOW CHART (250°C)</b>			
	UNLESS OTHERWISE SPECIFIED TOLERANCES: N/A		P/N: N/A	REV. A
	DWN.	Juan Mao	Dec-20-06	
	CHK.	YK Liao	Dec-20-06	
SHEET 1 OF 1	APP.	Joe Huff	Dec-20-06	