

P	LTR	DESCRIPTION	DATE	DWN	APVD
E4		PART 3-284046-7 RELEASED FOR PRODUCTION	19FEB2019	RK	PS
E5		3-2 TO 3-6 PART OBSOLETE	30AUG2020	DV	PS

- MATERIALS AND FINISH**
 HOUSING : PA 6-6, UL 94-V0, COLOR: GREEN.
 CAGE CLAMP : COPPER ALLOY, NICKEL PLATED.
 CONTACT SPRING : COPPER ALLOY, TIN PLATED.
 CLAMPING SCREW : M3, COPPER ALLOY, NICKEL PLATED.
- MECHANICAL**
 RECOMMENDED TIGHTENING TORQUE : 0.5 Nm
 WIRE STRIPPING LENGTH : 6 - 7.5 mm
- ELECTRICAL**
 WIRE RANGE : 12-30 AWG
 VOLTAGE RATING : 300 V
 CURRENT RATING : 15 A
 CONTACT RESISTANCE : <15 m Ohm
 INSULATION RESISTANCE : > 1000 M Ohm (500V DC)

- △4 NOT CUMULATIVE TOLERANCE.
- 5. INK MARKING, COLOR: BLACK.
- △6 WIRE ENTRY CLOSED
- △7 PRELIMINARY - NOT RELEASED FOR PRODUCTION
- △8 HOUSING: PA 6-6, UL 94-V0, COLOR:YELLOW

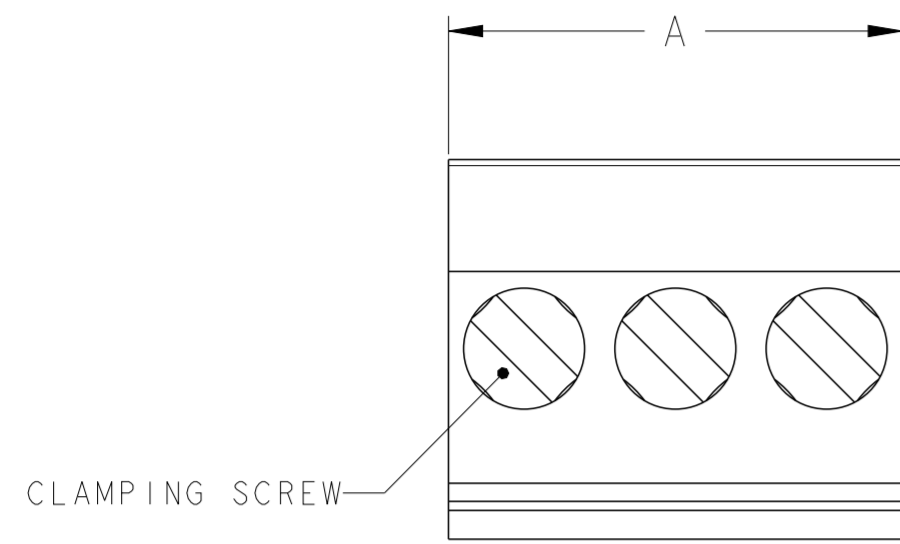

CLAMPING SCREW

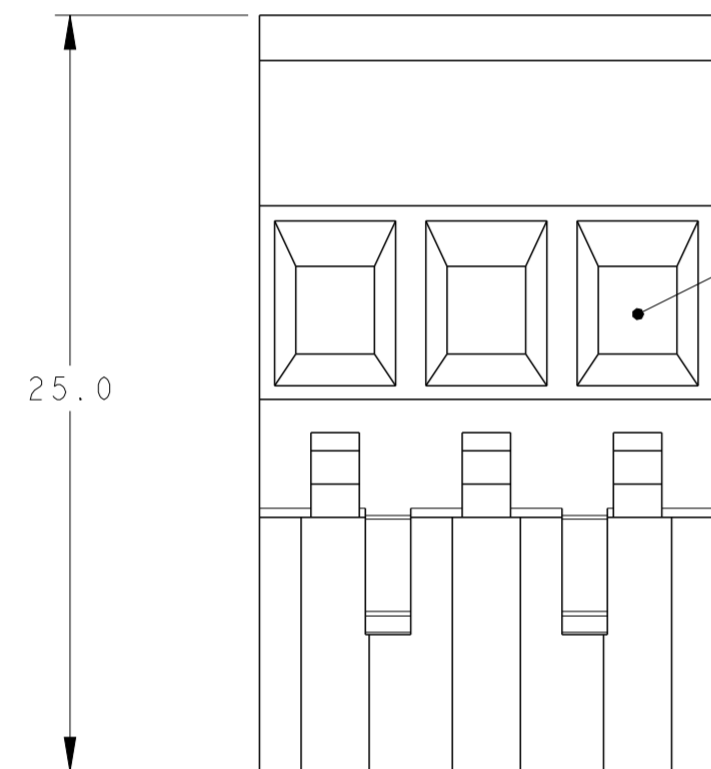

WIRE ENTRY

POLARIZATION KEY SLOT

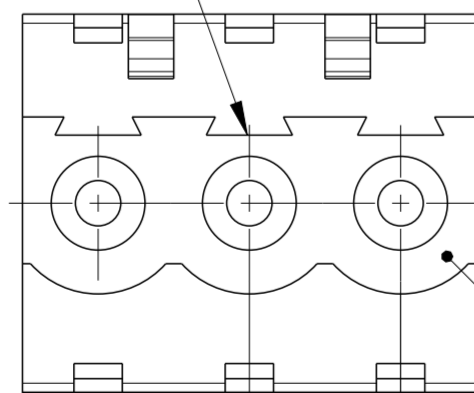

MATING FACE

△4
5.00±0.05
TYP

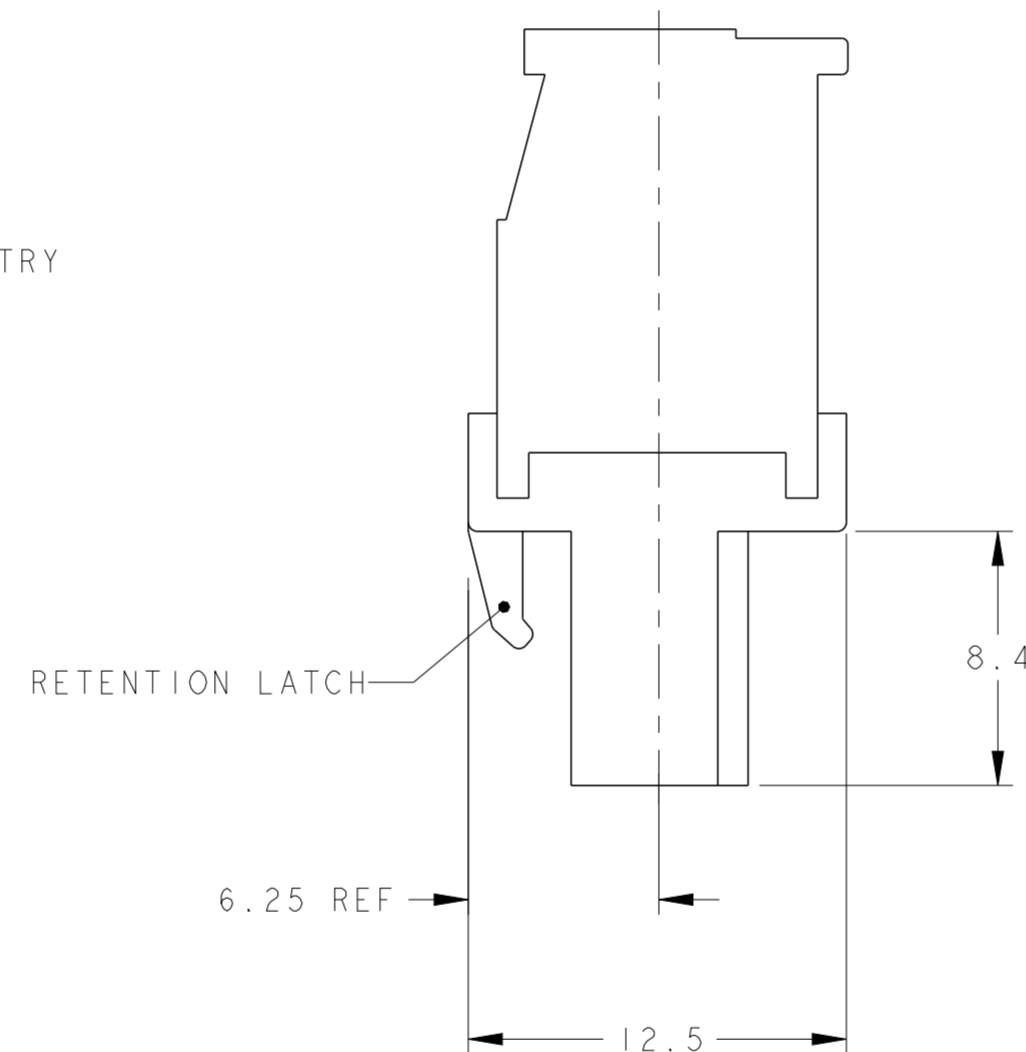

RETENTION LATCH

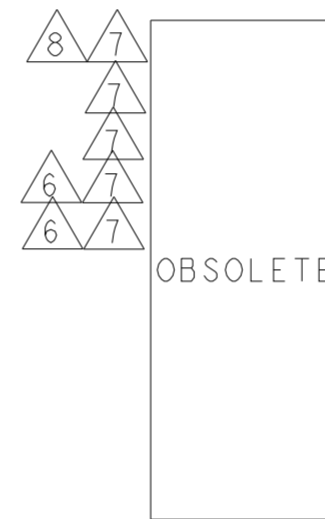

OBSOLETE

TIN PLATED	SEE SHEET 2	25.0	5	3-284046-7
TIN PLATED	-	15.0	3	3-284046-6
TIN PLATED	SEE SHEET 3	70.0	14	3-284046-5
TIN PLATED	SEE SHEET 3	50.0	10	3-284046-4
TIN PLATED	SEE SHEET 3	90.0	18	3-284046-3
TIN PLATED	SEE SHEET 3	80.0	16	3-284046-2
TIN PLATED	SEE SHEET 2	15.0	3	3-284046-1
TIN PLATED	SEE SHEET 2	10.0	2	3-284046-0
0.00076[.000030] SELECT GOLD	SEE SHEET 2	25.0	5	2-284046-9
	-	25.0	5	2-284046-8
	SEE SHEET 2	65.0	13	2-284046-7
	SEE SHEET 2	40.0	8	2-284046-6
	-	125.0	25	2-284046-5
	-	120.0	24	2-284046-4
	-	115.0	23	2-284046-3
	-	110.0	22	2-284046-2
	-	105.0	21	2-284046-1
	-	100.0	20	2-284046-0
	-	95.0	19	1-284046-9
	-	90.0	18	1-284046-8
	-	85.0	17	1-284046-7
	-	80.0	16	1-284046-6
	-	75.0	15	1-284046-5
	-	70.0	14	1-284046-4
	-	65.0	13	1-284046-3
	-	60.0	12	1-284046-2
	-	55.0	11	1-284046-1
	-	50.0	10	1-284046-0
	-	45.0	9	284046-9
	-	40.0	8	284046-8
	-	35.0	7	284046-7
	-	30.0	6	284046-6
	-	25.0	5	284046-5
	-	20.0	4	284046-4
	-	15.0	3	284046-3
	-	10.0	2	284046-2

TIN PLATED

CONTACT FINISH MARKING A NO OF POSN PART NUMBER

THIS DRAWING IS A CONTROLLED DOCUMENT.

DWN S. WELDON 05FEB2003
 CHK C. RICHARD 05FEB2003
 APVD C. RICHARD 05FEB2003

STE TE Connectivity

NAME: TERMINAL BLOCK, VERTICAL PLUG, STACKING, RIGHT HAND, 5.00mm PITCH

SIZE: A2 CAGE CODE: 0779 DRAWING NO: C-284046 RESTRICTED TO: 3

MATERIAL: SEE NOTES TOLERANCES UNLESS OTHERWISE SPECIFIED: SEE NOTES

0 PLC ±-
 1 PLC ±0.30
 2 PLC ±0.25
 3 PLC ±-
 4 PLC ±-
 ANGLES ±2°

PRODUCT SPEC: -
 APPLICATION SPEC: -
 WEIGHT: -

CUSTOMER DRAWING SCALE: 4:1 SHEET: 1 OF 3 REV: E5

P	LTR	DESCRIPTION	DATE	DWN	APVD
-		SEE SHEET 1	-	-	-

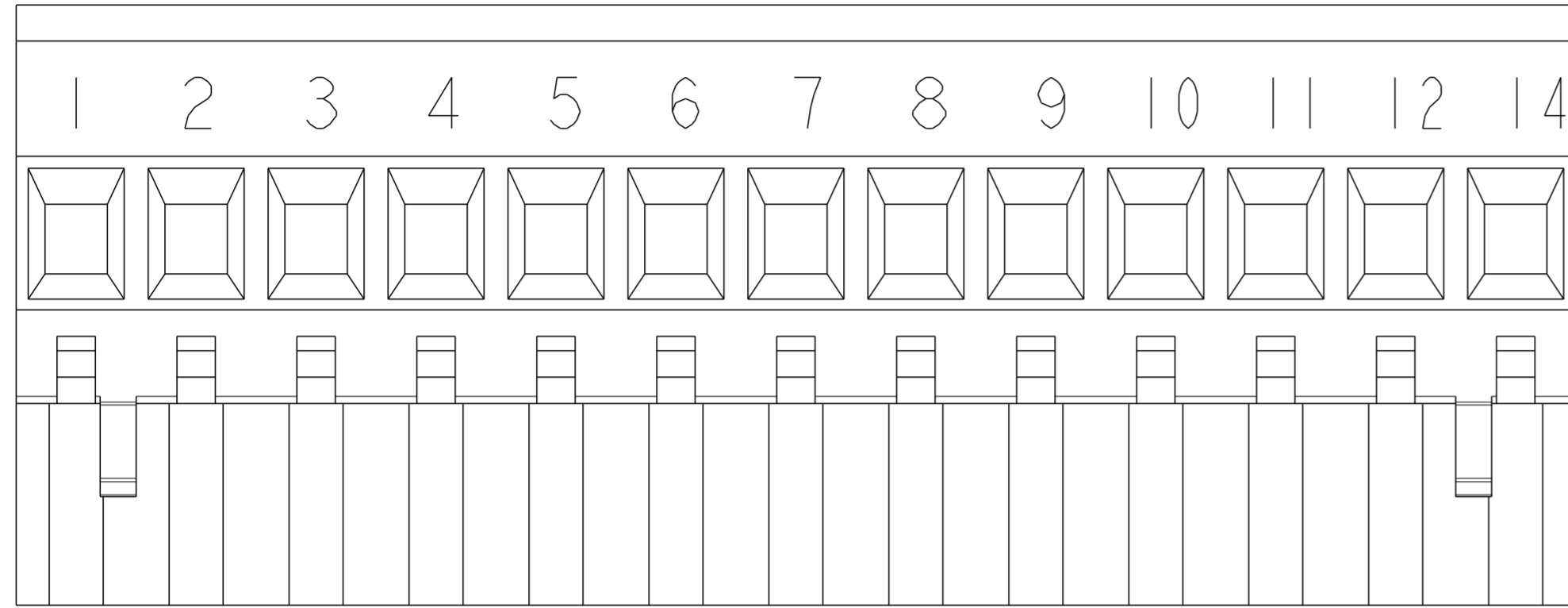

OBSOLETE ~~2-284046-7~~ AS SHOWN

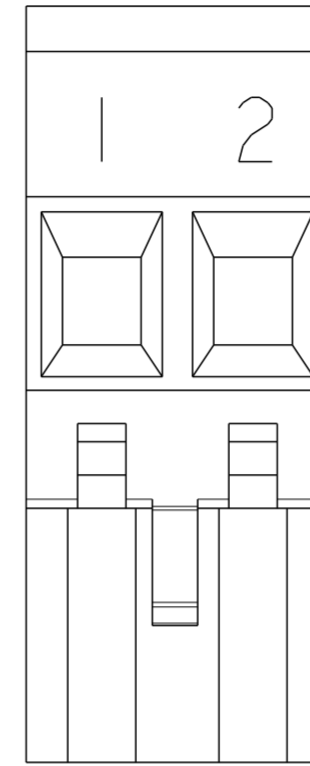

OBSOLETE ~~3-284046-0~~ AS SHOWN

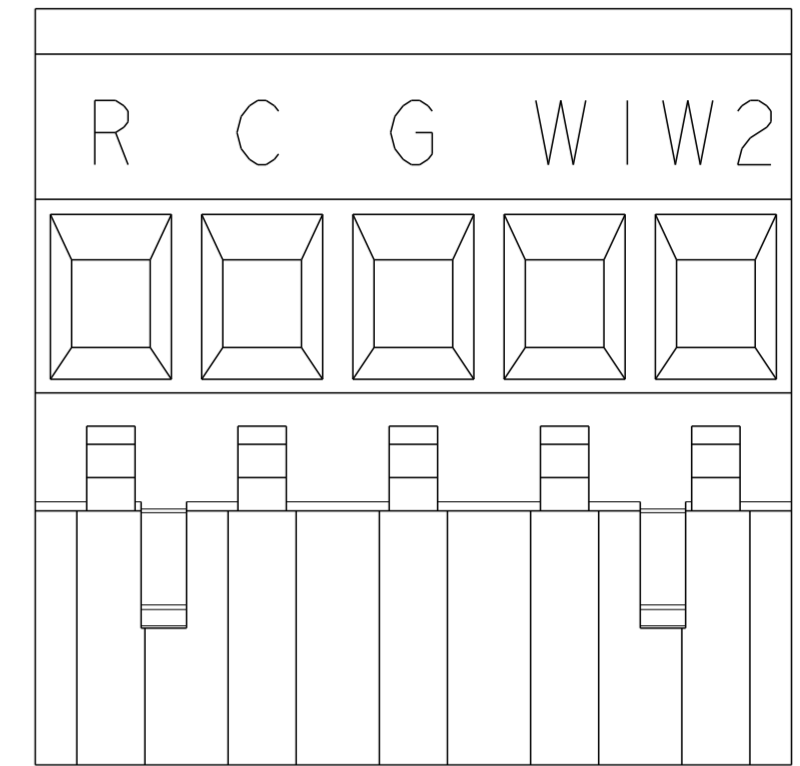

3-284046-7 AS SHOWN

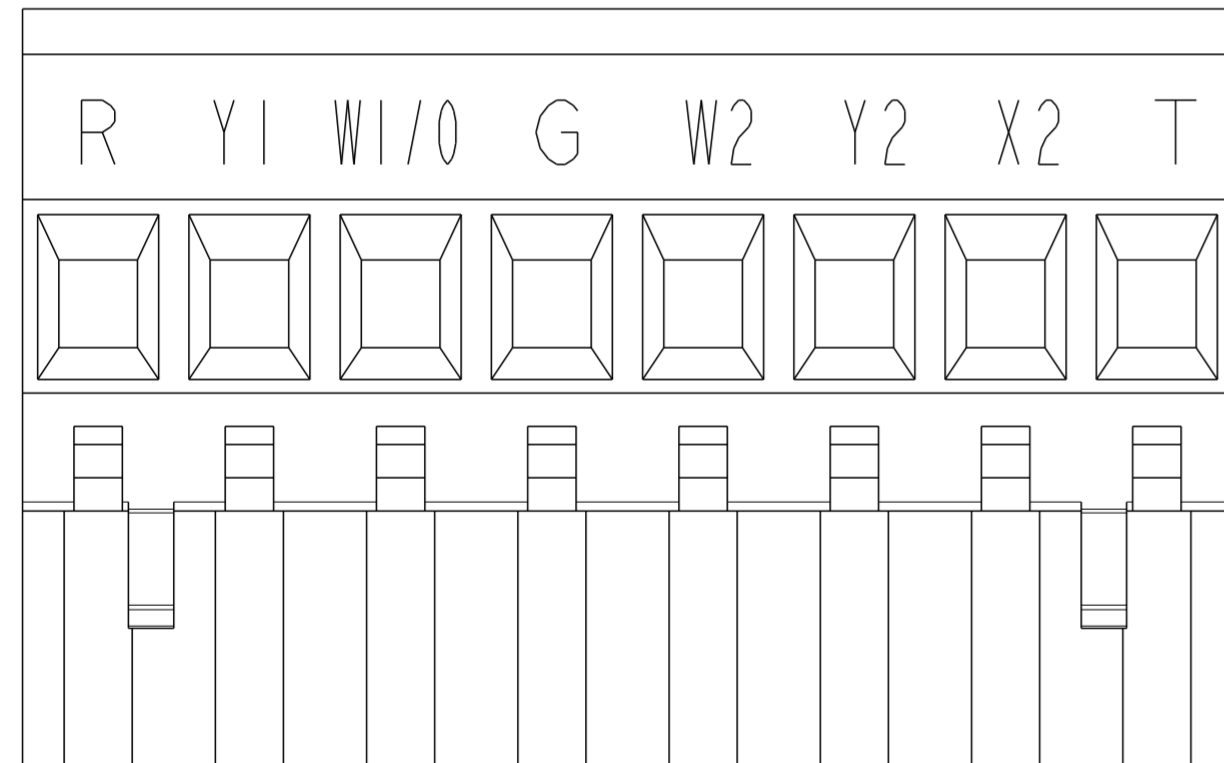

OBSOLETE ~~2-284046-6~~ AS SHOWN

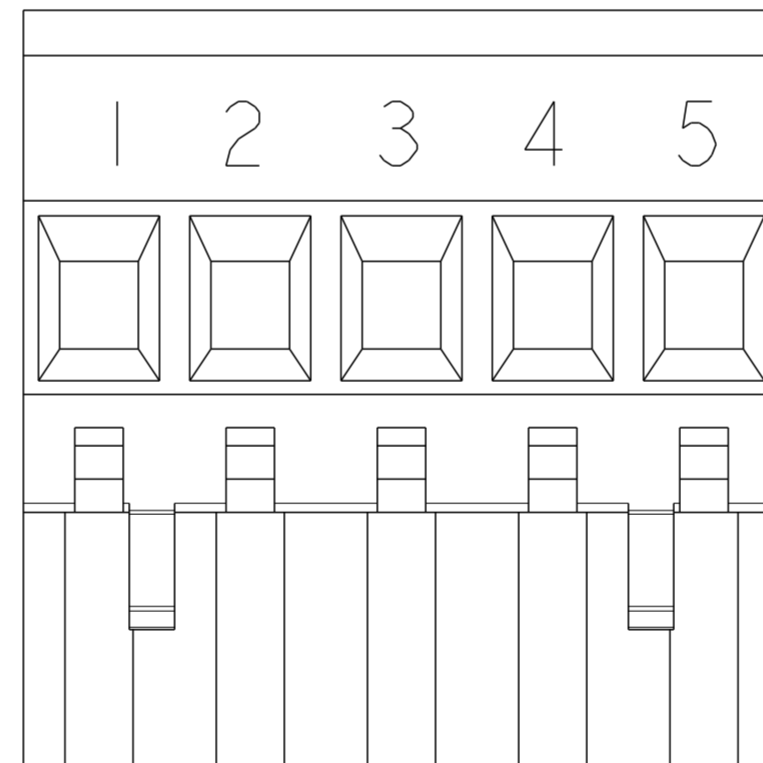

OBSOLETE ~~2-284046-9~~ AS SHOWN

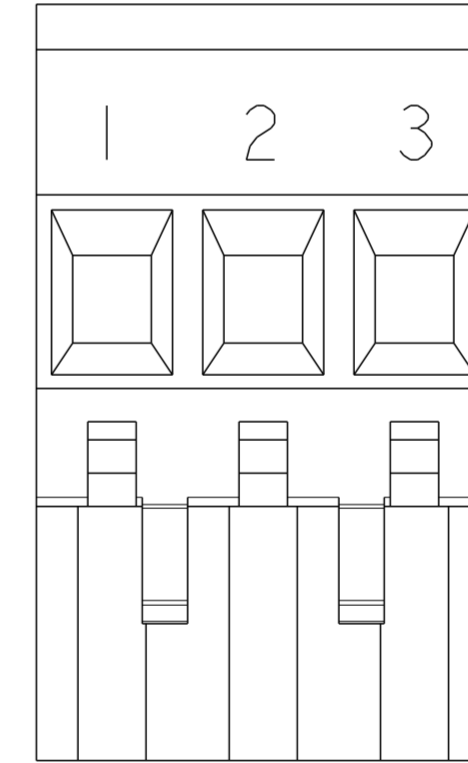

OBSOLETE ~~3-284046-1~~ AS SHOWN

THIS DRAWING IS A CONTROLLED DOCUMENT.		DWN S. WELDON 05FEB2003	 TE Connectivity
DIMENSIONS: mm		CHK C. RICHARD 05FEB2003	
TOLERANCES UNLESS OTHERWISE SPECIFIED: 0 PLC ± 1 PLC ±0.30 2 PLC ±0.25 3 PLC ± 4 PLC ± ANGLES ±2°		APVD C. RICHARD 05FEB2003	NAME TERMINAL BLOCK, VERTICAL PLUG, STACKING, RIGHT HAND, 5.00mm PITCH
MATERIAL SEE NOTES		PRODUCT SPEC -	SIZE A20779
FINISH SEE NOTES		APPLICATION SPEC -	CAGE CODE C-284046
		WEIGHT -	DRAWING NO C-284046
		CUSTOMER DRAWING	RESTRICTED TO
		SCALE 4:1	SHEET 2 OF 3
			REV E5

REVISIONS

P	LTR	DESCRIPTION	DATE	DWN	APVD
-		SEE SHEET 1	-	-	-

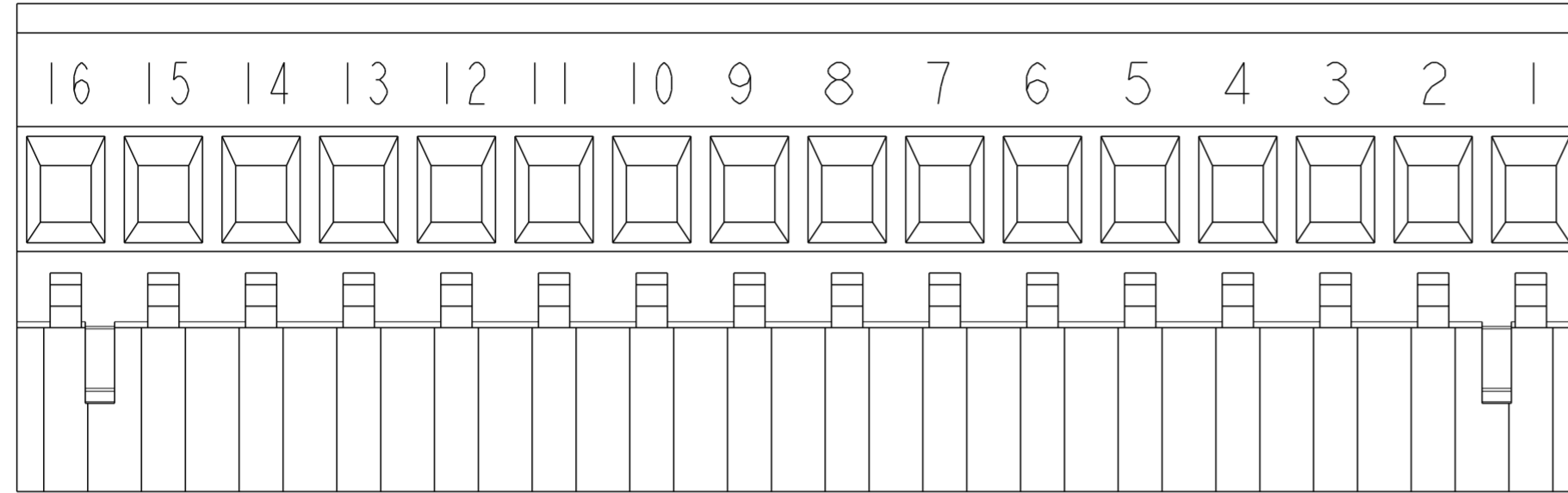

OBSOLETE ~~3-284046-2~~ AS SHOWN \triangle 6

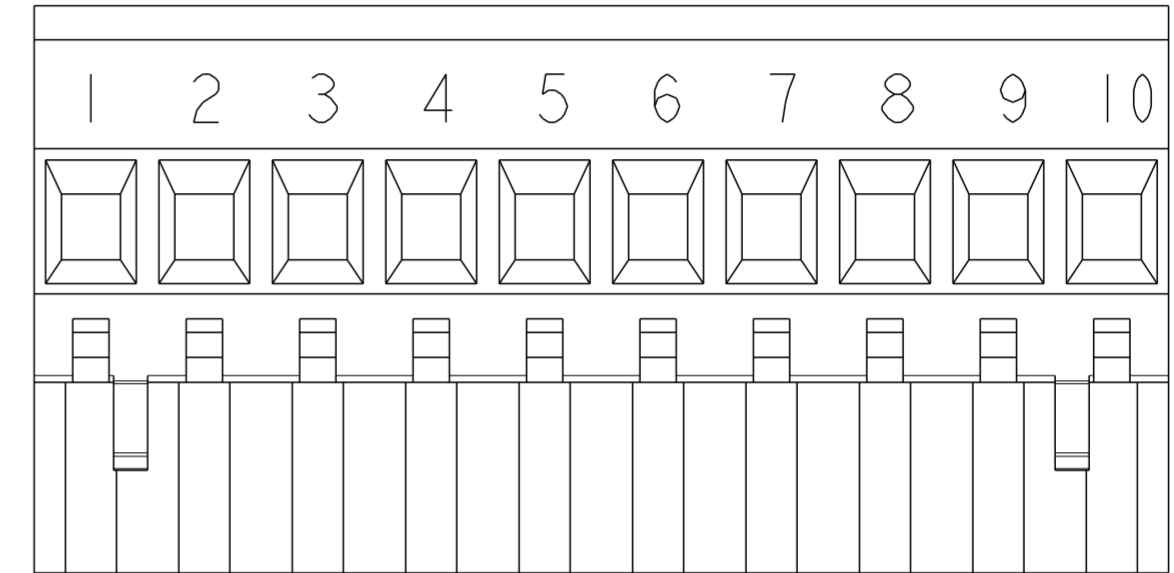

OBSOLETE ~~3-284046-4~~ AS SHOWN

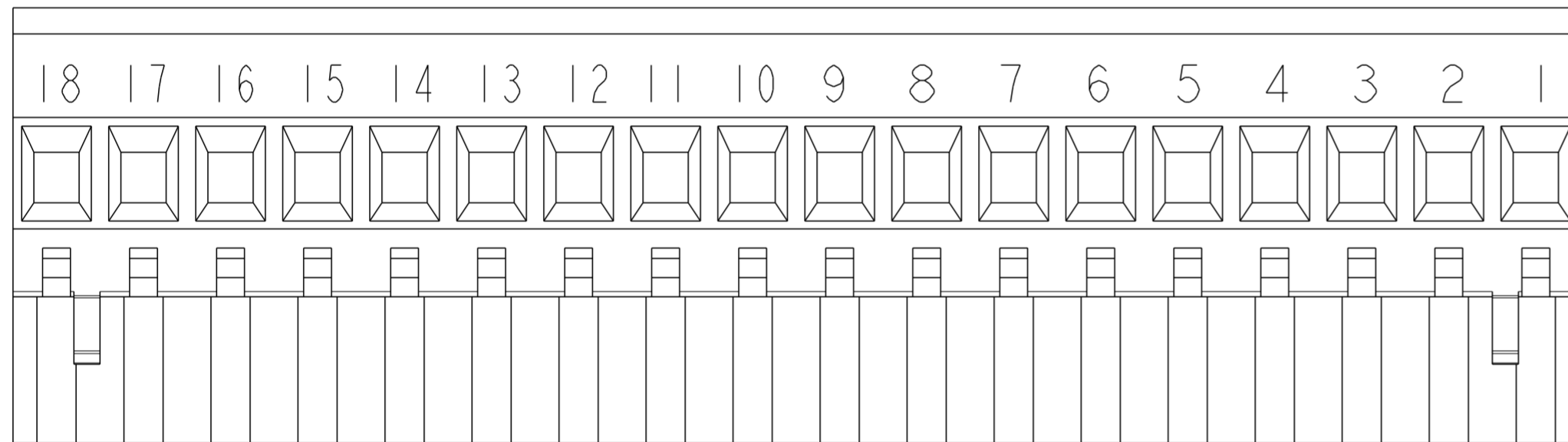

OBSOLETE ~~3-284046-3~~ AS SHOWN \triangle 6

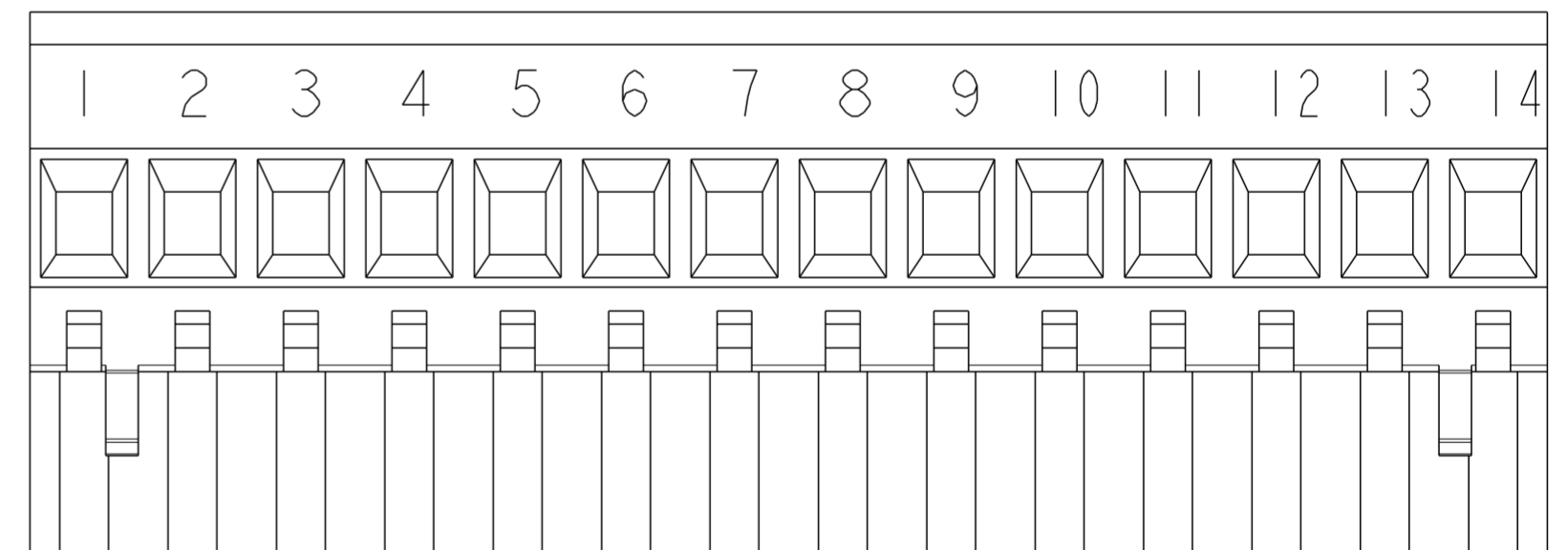

OBSOLETE ~~3-284046-5~~ AS SHOWN

THIS DRAWING IS A CONTROLLED DOCUMENT.		DWN S. WELDON 05FEB2003	TE Connectivity	
DIMENSIONS: mm		CHK C. RICHARD 05FEB2003		
TOLERANCES UNLESS OTHERWISE SPECIFIED:		APVD C. RICHARD 05FEB2003	NAME TERMINAL BLOCK, VERTICAL PLUG, STACKING, RIGHT HAND, 5.00mm PITCH	
0 PLC ± 1 PLC ±0.30 2 PLC ±0.25 3 PLC ± 4 PLC ± ANGLES ±2° FINISH		PRODUCT SPEC -	SIZE A2	CAGE CODE p0779
MATERIAL SEE NOTES		APPLICATION SPEC -	DRAWING NO C-284046	RESTRICTED TO
WEIGHT -		CUSTOMER DRAWING	SCALE 4:1	SHEET 3 OF 3
				REV E5