

Main Product Characteristics

V_{DSS}	150V
$R_{DS(on)}$	7.2m Ω
I_D	140A

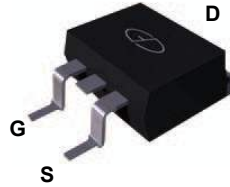

TO-263 (D²PAK)

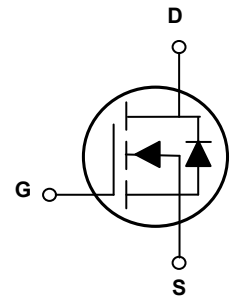

Schematic Diagram

Features and Benefits

- Excellent gate charge
- Low R_{ds(on)}
- Ideal for high-frequency switching
- Low conduction and switching power loss



Description

The GSGT15140 utilizes the latest techniques to achieve high cell density and low on-resistance. These features make this device extremely efficient and reliable for use in high efficiency switch mode power supply and a wide variety of other applications.

Absolute Maximum Ratings (T_C=25°C unless otherwise specified)

Parameter	Symbol	Value	Unit
Drain-Source Voltage	V_{DS}	150	V
Gate-Source Voltage	V_{GS}	±20	V
Drain Current-Continuous	I_D	140	A
Drain Current-Continuous(T _C =100°C)	$I_D(100^\circ\text{C})$	100	A
Pulsed Drain Current ¹	I_{DM}	560	A
Maximum Power Dissipation	P_D	320	W
Derating Factor		2.1	W/°C
Single pulse avalanche energy ⁵	E_{AS}	1296	mJ
Operating Junction and Storage Temperature Range	T_J, T_{STG}	-55 To 175	°C
Thermal Resistance, Junction-to-Case ²	$R_{\theta JC}$	0.47	°C/W

Electrical Characteristics ($T_C=25^\circ\text{C}$ unless otherwise specified)

Parameter	Symbol	Condition	Min	Typ	Max	Unit
Off Characteristics						
Drain-Source Breakdown Voltage	BV_{DSS}	$V_{GS}=0V, I_D=250\mu A$	150	155	-	V
Zero Gate Voltage Drain Current	I_{DSS}	$V_{DS}=150V, V_{GS}=0V$		-	1	μA
Gate-Body Leakage Current	I_{GSS}	$V_{GS}=\pm 20V, V_{DS}=0V$		-	± 100	nA
On Characteristics ³						
Gate Threshold Voltage	$V_{GS(th)}$	$V_{DS}=V_{GS}, I_D=250\mu A$	2.0	3.3	4.0	V
Drain-Source On-State Resistance	$R_{DS(ON)}$	$V_{GS}=10V, I_D=70A$		6	7.2	m Ω
Forward Transconductance	g_{FS}	$V_{DS}=10V, I_D=70A$		-	-	S
Dynamic Characteristics ⁴						
Input Capacitance	C_{iss}	$V_{DS}=75V, V_{GS}=0V,$ $F=1.0MHz$	-	5500	-	PF
Output Capacitance	C_{oss}		-	600	-	PF
Reverse Transfer Capacitance	C_{rss}		-	7	-	PF
Switching Characteristics ⁴						
Turn-on Delay Time	$t_{d(on)}$	$V_{DD}=75V, I_D=70A$ $V_{GS}=10V, R_G=4.7\Omega$	-	26	-	nS
Turn-on Rise Time	t_r		-	36	-	nS
Turn-Off Delay Time	$t_{d(off)}$		-	47	-	nS
Turn-Off Fall Time	t_f		-	15	-	nS
Total Gate Charge	Q_g	$V_{DS}=75V, I_D=70A,$ $V_{GS}=10V$	-	74		nC
Gate-Source Charge	Q_{gs}		-	32		nC
Gate-Drain Charge	Q_{gd}		-	11		nC
Drain-Source Diode Characteristics						
Diode Forward Voltage ³	V_{SD}	$V_{GS}=0V, I_F=I_S$	-		1.2	V
Diode Forward Current ²	I_S		-	-	140	A
Reverse Recovery Time	t_{rr}	$T_J = 25^\circ\text{C}, I_F = I_S$ $di/dt = 100A/\mu s^3$		146		nS
Reverse Recovery Charge	Q_{rr}		-	485		nC

Notes:

1. Repetitive Rating: Pulse width limited by maximum junction temperature.
2. Surface Mounted on FR4 Board, $t \leq 10$ sec.
3. Pulse Test: Pulse Width $\leq 300\mu s$, Duty Cycle $\leq 2\%$.
4. Guaranteed only by design.
5. EAS condition : $T_J=25^\circ\text{C}, V_{DD}=50V, V_G=10V, L=0.5mH, R_g=25\Omega$

Test Circuits and Waveforms

EAS Test Circuit:

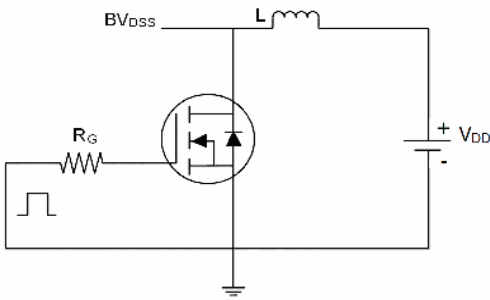

Gate charge test circuit:

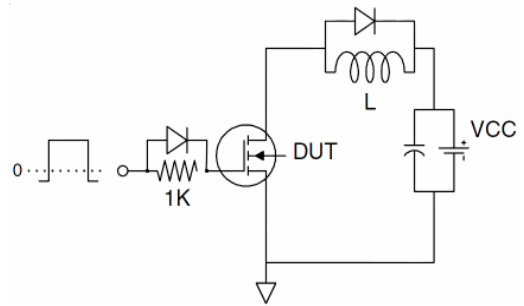

Switching Time Test Circuit:

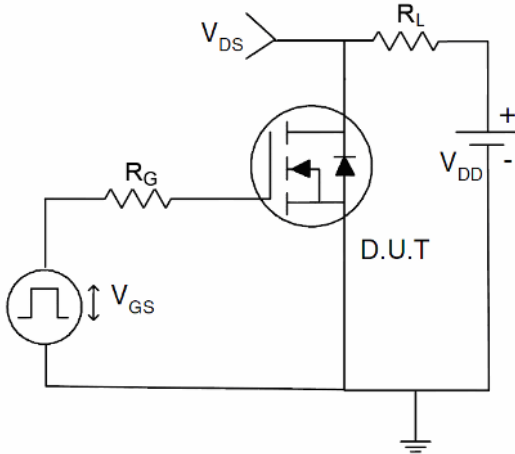

Typical Electrical and Thermal Characteristic Curves

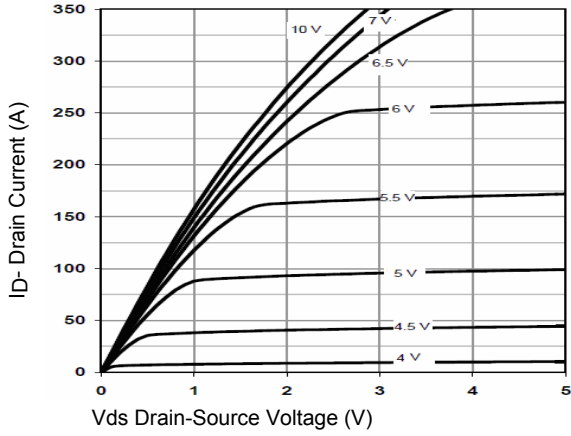

Figure 1. Output Characteristics

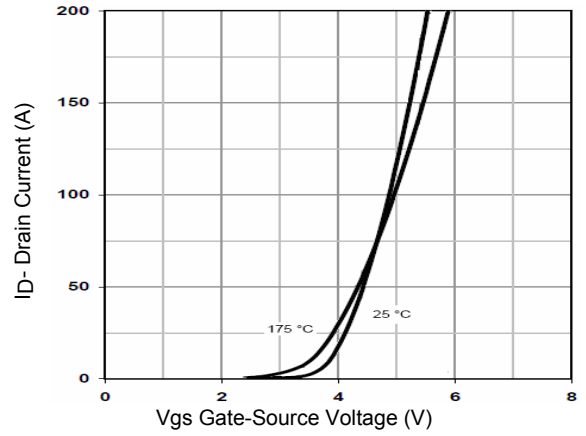

Figure 2. Transfer Characteristics

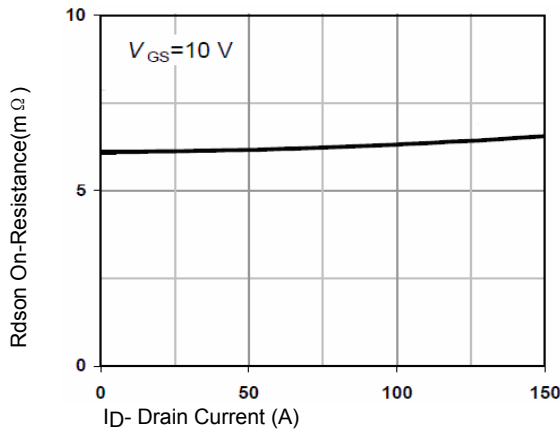

Figure 3. Rdson- Drain Current

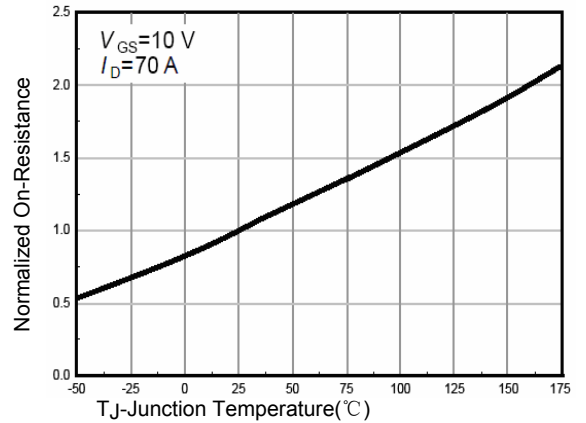

Figure 4. Rdson-Junction Temperature

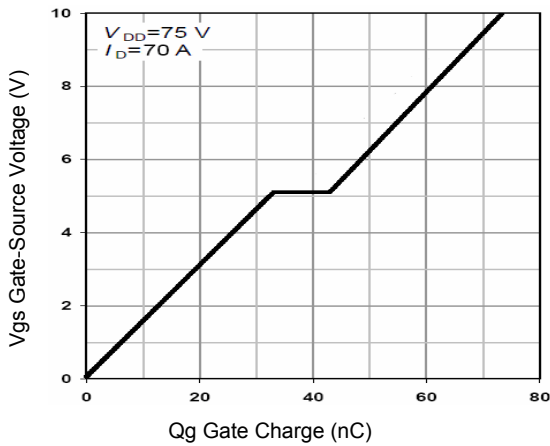

Figure 5. Gate Charge

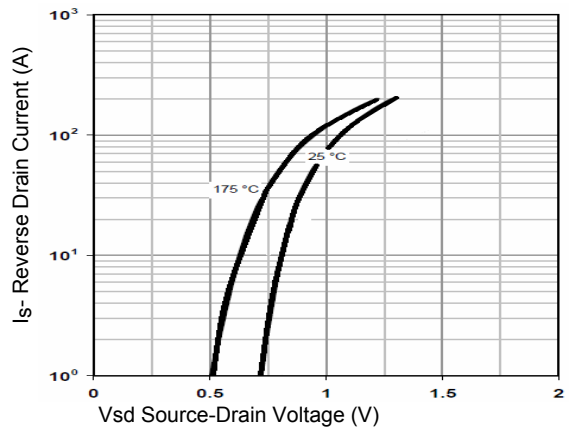

Figure 6. Source- Drain Diode Forward

Typical Electrical and Thermal Characteristic Curves

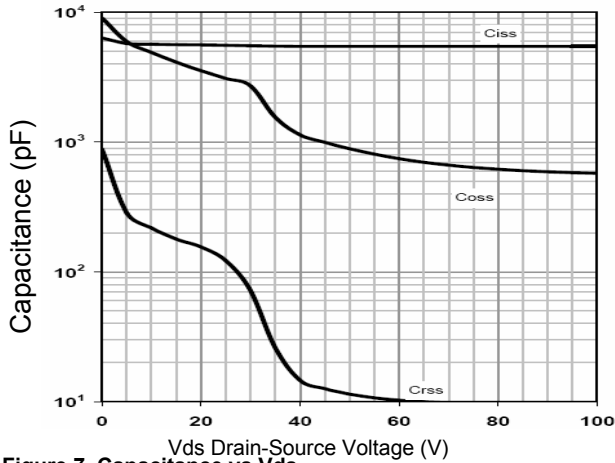

Figure 7. Capacitance vs Vds

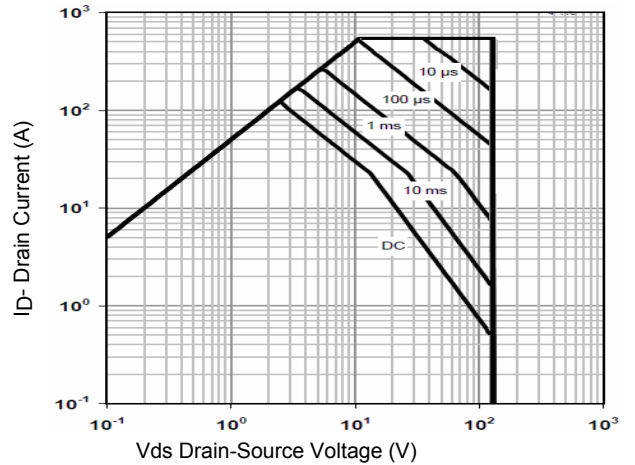

Figure 8. Safe Operation Area

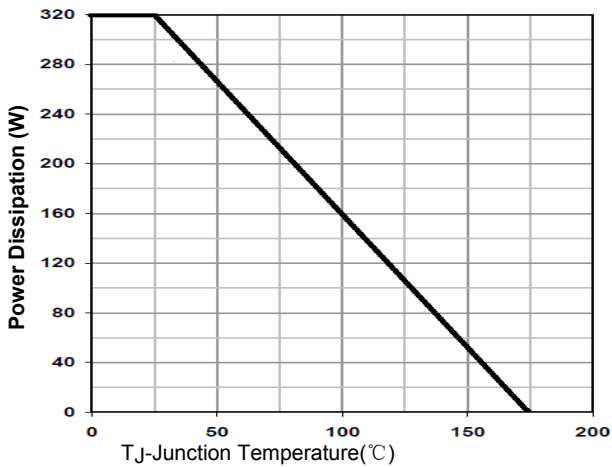

Figure 9. Power De-rating

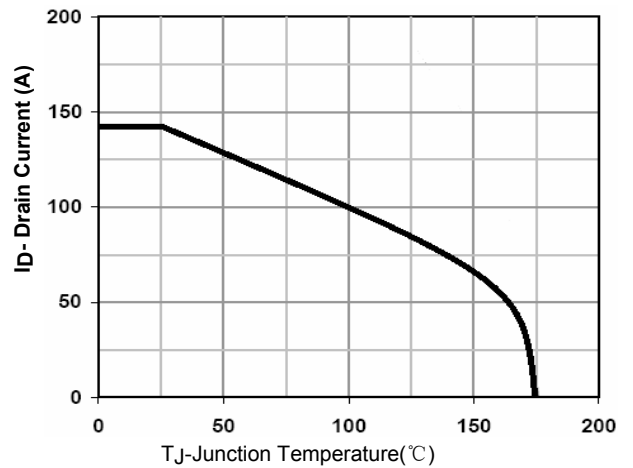

Figure 10. Current De-rating

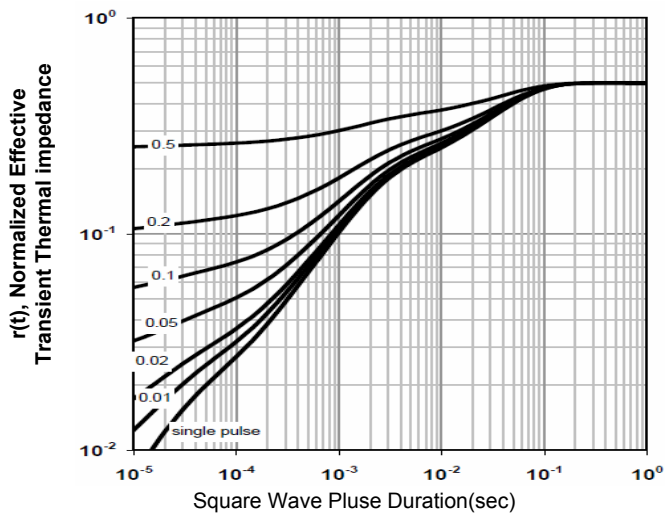
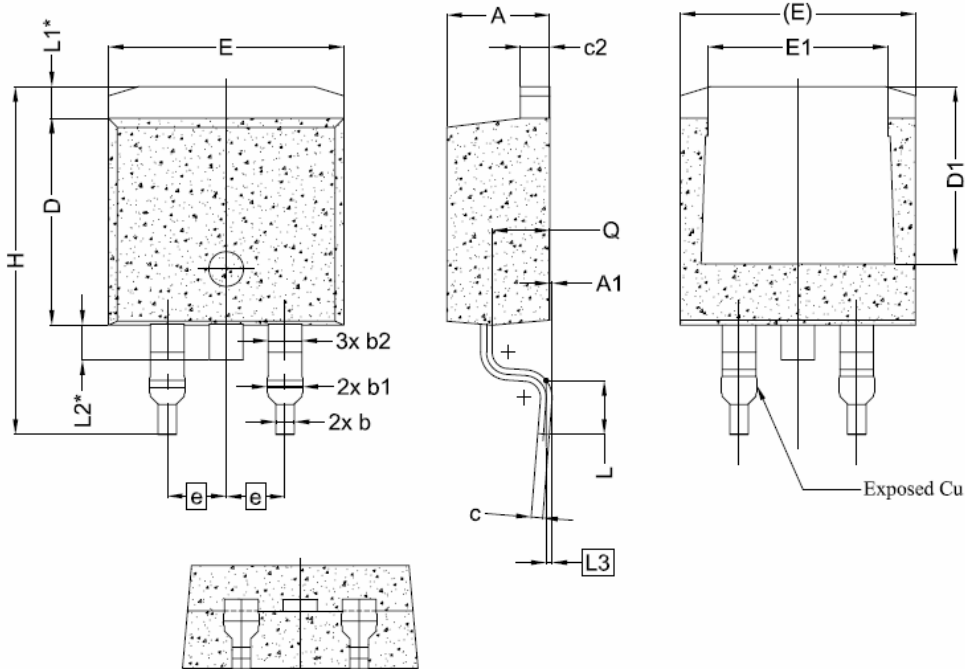

Figure 11. Normalized Maximum Transient Thermal Impedance

Package Outline Dimensions

TO-263 (D²PAK)



Symbol	Dimensions In Millimeters		
	Min.	Nom.	Max.
A	4.24	4.44	4.64
A1	0.00	0.10	0.25
b	0.70	0.80	0.90
b1	1.20	1.55	1.75
b2	1.20	1.45	1.70
c	0.40	0.50	0.60
c2	1.15	1.27	1.40
D	8.82	8.92	9.02
D1	6.86	7.65	-
E	9.96	10.16	10.36
E1	6.89	7.77	7.89
e	2.54BSC		
H	14.61	15.00	15.88
L	1.78	2.32	2.79
L1	1.36 REF.		
L2	1.50 REF.		
L3	0.25 BSC		
Q	2.30	2.48	2.70