

[Twin Turbo Series](#)

TUHT-V88Y-930-Q



More Information



Specifications

Mounting	Panel Mount with Volume Control
Color	Yellow
Operating Mode	Extra Loud Stacatto Tone
Operating Voltage	9-30 Vdc
Operating Frequency	3000±500 Hz
Typical Operating Current	65 mA at 9 Vdc 125 mA at 30 Vdc
Typical Sound Pressure	85 ±5 dB(A) at 9 Vdc at 24 inches (61 cm), at 25°C 103 ±5 dB(A) at 30 Vdc at 24 inches (61 cm), at 25°C
Termination	Quick Connect Blades
Termination Strength	Pull test with a maximum of 22 pounds (10 kg) load
Operating Temperature	-20_C to +65_C
Storage Temperature	-40_C to +85_C
Surge Voltage	20% over maximum rated voltage for less than 5 minutes
Reverse Voltage Protection	To the maximum operating voltage
Construction Materials	Lens/Case- Yellow Translucent Polycarbonate 94 VO Potting- 2 parts epoxy resin or silicone, black
Gasket	Gasket (Included) 0.125" thick, 60 Durometer Neoprene ASTM B117 Certified - Withstands exposure to salt spray for 300 hours IP 68 Certified - Withstands water submergence and dust exposure
Construction Materials	Humidity- 95% relative humidity at +40_C continuously for 100 hours. Vibration- Withstands vibration between 0 and 55 Hz. on all axes.
Life Expectancy	127 years under normal operating conditions.
Warranty	For a period of two years from the date of manufacture under normal operating conditions.
Notes	This product is not intended as a life safety device.
Terms and Conditions of Sale	Link here

Dimensions

BACK



RING

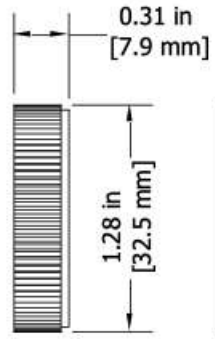

GASKET



SIDE

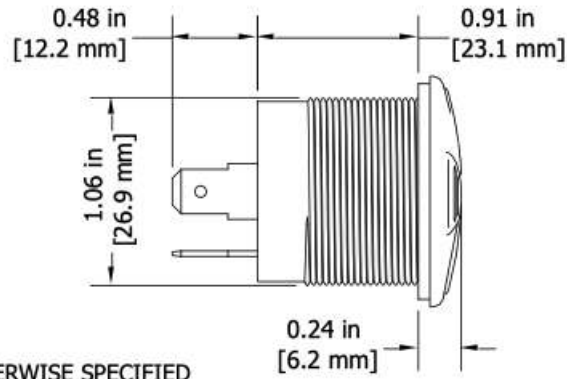

FRONT



TOLERANCES ARE ± 0.03 in [± 0.76 mm] UNLESS OTHERWISE SPECIFIED