

## Features

- Low forward voltage drop
- High junction temperature
- Moisture sensitivity: level 1, per J-STD-020
- Plastic package has underwriters laboratory flammability classification 94V-0
- Add suffix 'E' for halogen-free
- Halogen-free according to IEC 61249-2-21 definition
- AEC-Q101 qualified



Package: DO-214AC (SMA)

## Applications

For use in low voltage, high frequency inverters, free wheeling and polarity protection applications.

## Maximum Ratings (T<sub>A</sub> = 25°C unless otherwise noted)

Parameter	Symbol	SK5C0A	Unit
Maximum Repetitive Peak Reverse Voltage	V <sub>RRM</sub>	200	V
Maximum RMS Voltage	V <sub>RMS</sub>	140	V
Maximum DC Blocking Voltage	V <sub>DC</sub>	200	V
Maximum Average Forward Rectified Current	I <sub>F(AV)</sub>	5.0	A
Peak Forward Surge Current (8.3 ms single half sine-wave superimposed on rated load)	I <sub>FSM</sub>	120	A
Operating Junction and Storage Temperature Range	T <sub>J</sub> , T <sub>STG</sub>	-55 to +150	°C

## Electrical Characteristics (T<sub>A</sub> = 25°C unless otherwise noted)

Parameter	Test Conditions	Symbol	Value	Unit
Maximum Instantaneous Forward Voltage	I <sub>F</sub> =5A	V <sub>F</sub>	0.85	V
Maximum DC Reverse Current at Rated DC Blocking Voltage	T <sub>A</sub> =25°C	I <sub>R</sub>	30	μA
	T <sub>A</sub> =125°C		1000	
Typical Junction Capacitance	4.0 V, 1 MHz	C <sub>J</sub>	96	pF

## Thermal Characteristics

Parameter	Symbol	Value	Unit
Typical Thermal Resistance <sup>(1)</sup>	R <sub>θJA</sub>	75	°C/W
	R <sub>θJC</sub>	38	
	R <sub>θJL</sub>	15	

Note1: Thermal resistance from junction to lead, mounted on PCB with 8.0×8.0mm copper pads.

**Ratings and Characteristics Curves**

( $T_A = 25^\circ\text{C}$  unless otherwise noted)

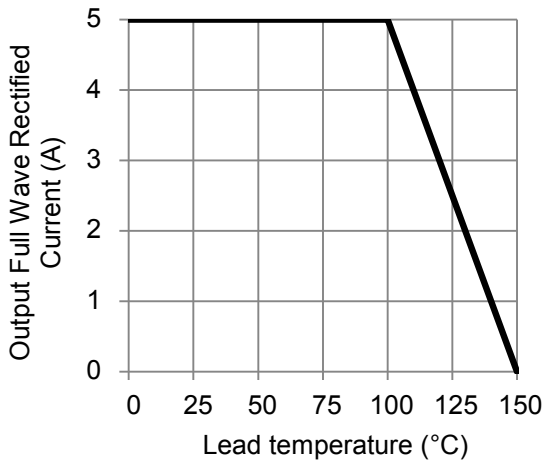

Figure 1. Forward Current Derating Curve

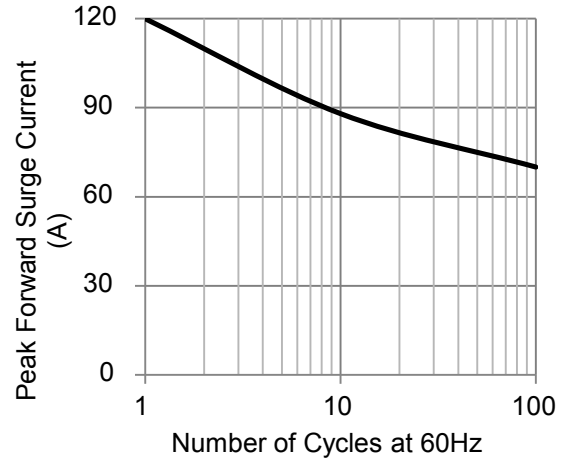

Figure 2. Maximum Non-Repetitive Peak Forward Surge Current

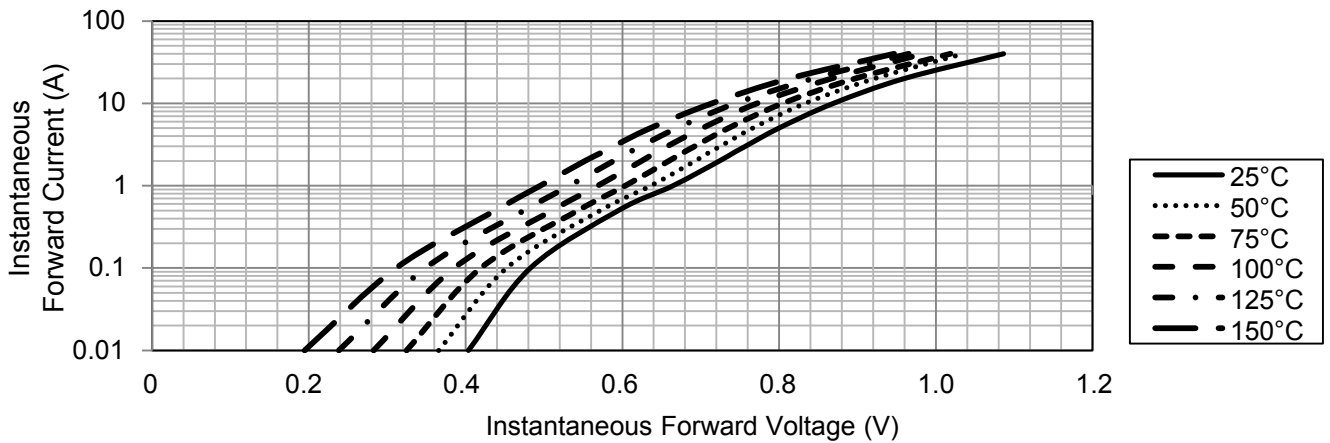

Figure 3. Typical Instantaneous Forward Characteristics

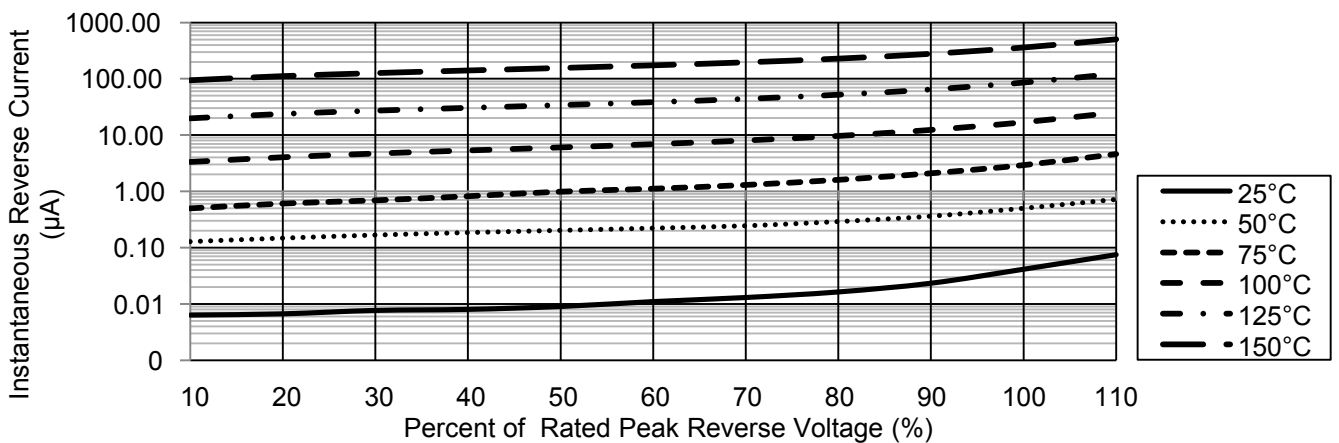
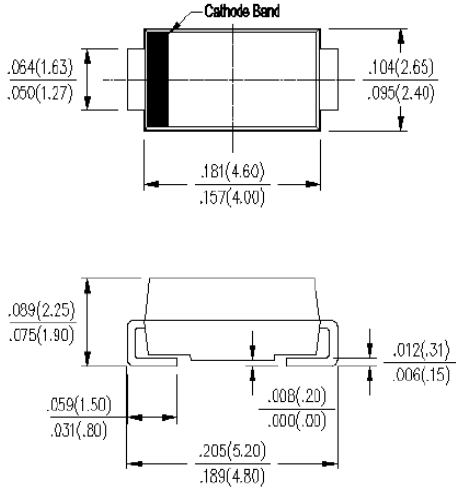

Figure 4. Typical Reverse Characteristics

## Package Outline Dimensions

in inches (millimeters)



## DO-214AC (SMA)

### MOUNTING PAD LAYOUT

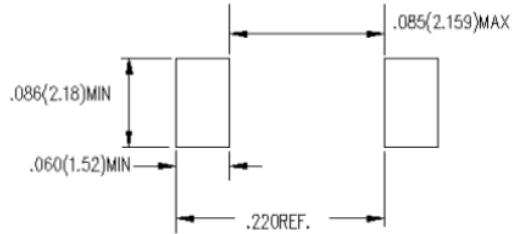

## Packing Information

7500 pcs/Reel, 18 Reels/Box, 12mm Tape, 13" Reel

### Tape & Reel Specification

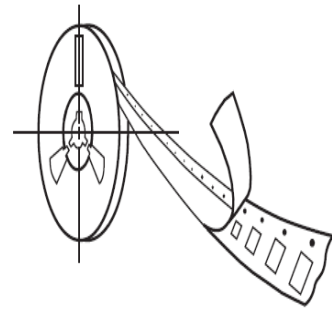
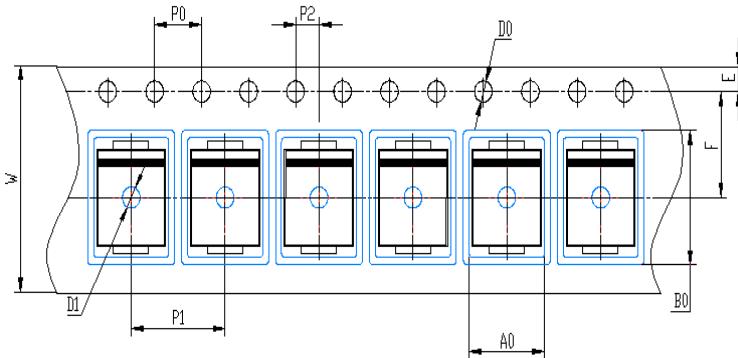

Symbol	SMA(mm)
W	12±0.2
E	1.75±0.1
F	5.5±0.05
D0	1.5±0.1
D1	1.50 +0.1/-0
P0	4.0±0.1
P1	4.0±0.1
P2	2.0±0.05
A0	2.65±0.1
B0	5.25±0.1

**Soldering Parameters**

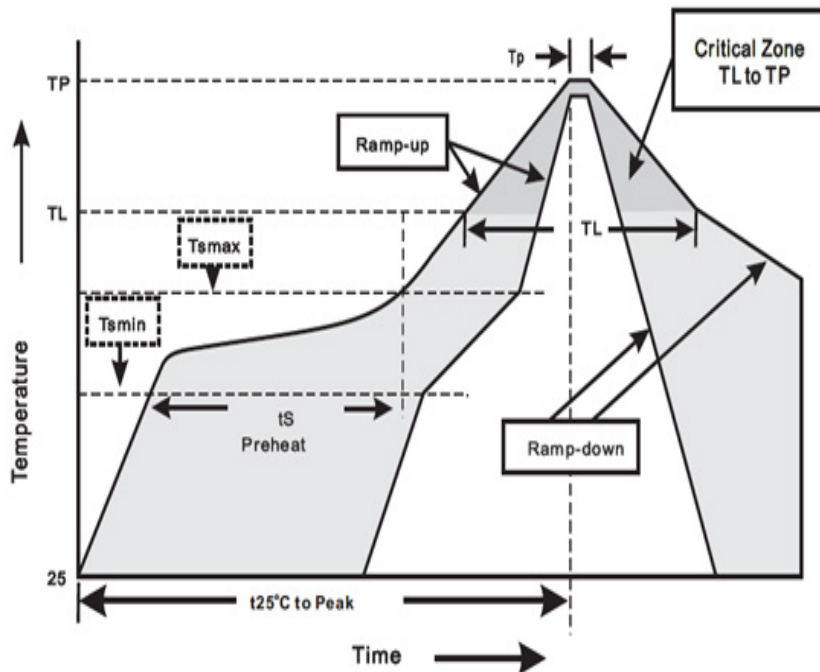

Reflow Soldering		Sn-Pb Eutectic Assembly	Pb-Free Assembly
Pre Heat	- Temperature Min (Ts min)	100°C	150°C
	- Temperature Max (Ts max)	150°C	200°C
	- Time (min to max) (ts)	60 – 120 secs	60 – 180 secs
Average ramp up rate (Liquidus) Temp (TL) to peak		3°C/second max	3°C/second max
TS(max) to TL - Ramp-up Rate		3°C/second max	3°C/second max
Reflow	- Temperature (TL) (Liquidus)	183°C	217°C
	- Time (min to max) (ts)	60 – 150 seconds	60 – 150 seconds
Peak Temperature (TP)		240+0/-5 °C	240+0/-5°C
Time within 5°C of actual peak Temperature (tp)		10 –30 seconds	20 – 40 seconds
Ramp-down Rate		6°C/second max	6°C/second max
Time 25°C to peak Temperature (TP)		6 minutes max	8 minutes max
Do not exceed		260°C	260°C

Wave Soldering	
Peak Temperature	260+0/-5°C
Dipping Time	10 seconds
Soldering	1 time