

bqMTester User's Guide

• **FEATURES**

- Programs and calibrates smart battery modules based on the bq20z80.
- Calibrates coulomb counter offset, voltage, temperature, and current.
- Programs serial number, date, pack lot code, and other defaults obtained from a *golden* data image file.
- Test software is Windows® 2000 and Windows XP compatible
- Data logging feature preserves calibration records.

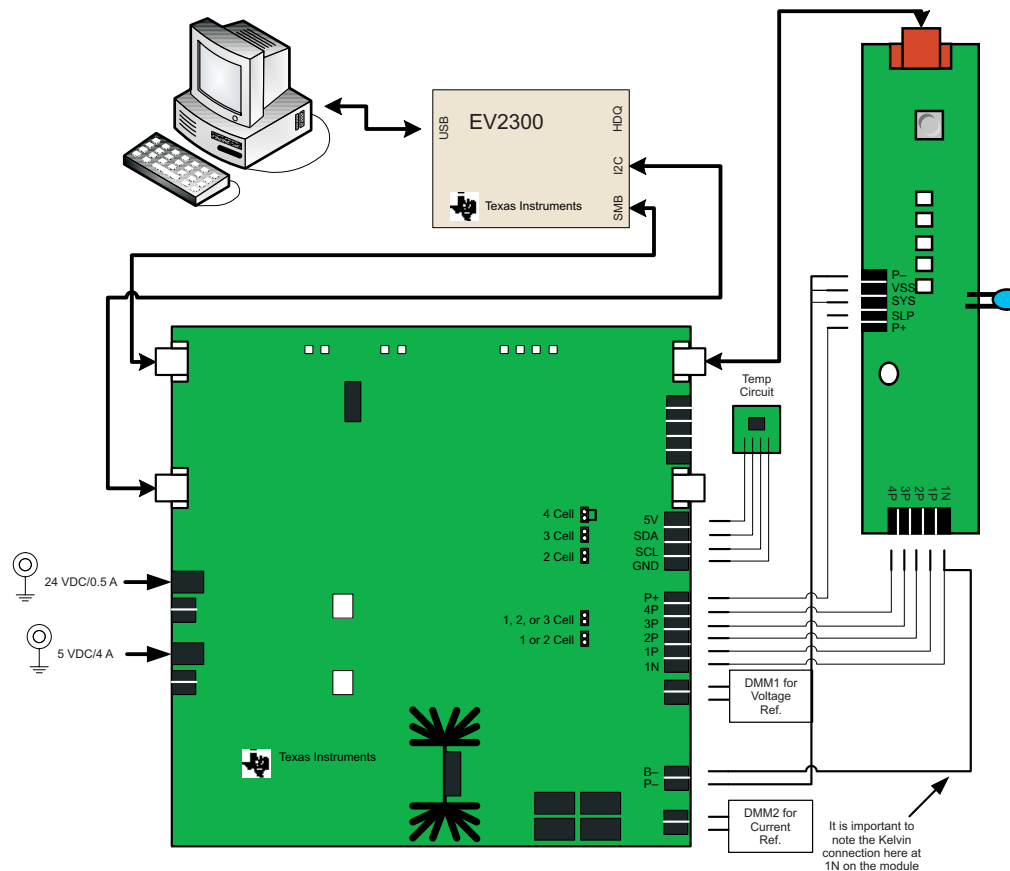

The bqMTester from Texas Instruments is designed to calibrate and program electronic smart battery modules based on the bq20zXX and future advanced battery gas gauges. The bqMTester consists of a software suite, a maximum of 12 calibration boards (HPA169) and an equal number of communication boards (EV2300 – purchased separately).

One HPA169 calibration board is included in the bqMTester kit when purchased from Texas Instruments. See the bqMTester product folder for more information:
<http://focus.ti.com/docs/toolsw/folders/print/bqmtester.html>.

Contents

1	Installation and Setup	3
2	Functional Overview: Exploring How Multi-Station Tester Works	4
3	Software Installation	6
4	Setup	18
5	Multi-Station Testing (MultiStationTester.exe): Individual Station Interface Connections	22
6	Multiple Station Setup	24
7	MultiStation Testing	29
Appendix A	Theory of Operation for HPA169 Calibration Board	35
Appendix B	HPA169 Schematic	37
Appendix C	HPA169 Cal Board Bill of Materials.....	39
Appendix D	HPA169 Board Layout.....	41
Appendix E	Error Code Definitions	46

List of Figures

1	bqMTester Multi-Station Flow	4
2	Included Hardware With bqMTester Kit.....	5
3	Cycle Count Modification in GG File Using Notepad	20
4	EV Software Pro Screen	21
5	TesterDFReader.exe Software	22
6	One Testing Station: EV2300/HPA169 Cal Board/Smart Battery Module Connections	23
7	External Temperature Sensor Connection.....	23
8	Station Setup Program	24
9	Multi-Station Setup.....	25
10	Global Configuration Screen.....	26
11	Example Targets File	29
12	MultiStation Tester Window.....	30
13	Update VTI Window.....	31
14	Global.ini file	33

List of Tables

1	HPA169A Bill of Materials.....	39
2	Error Code Definitions	46

Trademarks

Windows is a registered trademark of Microsoft Corporation.
All other trademarks are the property of their respective owners.

1 Installation and Setup

1.1 Minimum System Requirements

1.1.1 bqMTester Multi Station Tester

NOTE: Do not use Texas Instruments' EVMs for production. <http://www.ti.com/legal/terms-of-sale/standard-evaluation-terms.html>.

- Computer: PC or compatible.
- Operating System: Windows 2000, or Windows XP. Operation with Windows 98SE may be possible, but is untested and unsupported.
- Minimum video resolution is 640 x 480, recommended: 800 x 600 or above.
- 1 available USB port.
- 1 EV2300 USB-Based PC Interface Board for Battery Fuel Gauge Evaluation, available for purchase from Texas Instruments, that includes the *USB Tester Ready* label (firmware version 3.1L or greater). The bqMtester software will verify the EV2300 compatibility as described in section 7.
- 1 Texas Instruments HPA169 Calibration Circuit Board (Supplied in bqMTester Kit).
- For Multi-Station support: 5V/4A and 24V/0.5A power supplies with isolated grounds (not included).
- 10MB available hard drive space.
- Traceable Digital Multi-Meter (DMM) capable of measuring 2.5A and 20V accurate to less than 1mV and 1mA.
- Traceable Temperature probe accurate to 0.1°C.

2 Functional Overview: Exploring How Multi-Station Tester Works

2.1 bqMTester: Multi-Station Tester

The bqMTester software is a suite of programs used as a whole to calibrate and test bq20zXX modules. It has 4 executables. Two of them, StationSetup.exe and TesterDFReader.exe, are used for module test preparation. The other two, bqTester.exe and MultiStationTester.exe, are used for testing. This section discusses the 4 executables as they relate to Multi-Station Testing Theory of Operation.

- **MultiStationTester.exe:** The main test program for multi-site testing. This program can only be run after StationSetup.exe has been run. Its only purpose is to coordinate background bqTester.exe functions and data. It initiates tests, handles priority conflicts, and handles/stores test statistical data received from bqTester.exe.
- **bqTester.exe:** This program is the backbone of the Multi-Station Tester. It performs all the testing. bqTester.exe is a background object that is not visible to the user. There is an instance of bqTester.exe running for each EV2300 test station connected to the PC. The bqMtester (MultiStationTester.exe) software calls on bqTester.exe to perform all the calibration and testing. All data from this testing is reported back to bqMtester where it is displayed and logged.
- **StationSetup.exe:** This is the setup program for MultiStationTester.exe. This program must be run prior to running MultiStationTester.exe. The EV2300/Temperature/Test Limits are configured using this program.
- **TesterDFReader.exe:** This program is used to read the "Golden Image File" from an optimized module. This file is then used for testing with the MultiStationTester.exe program. If a Golden Image File is not used then only calibration data as enabled will be installed in the bq20zXX.

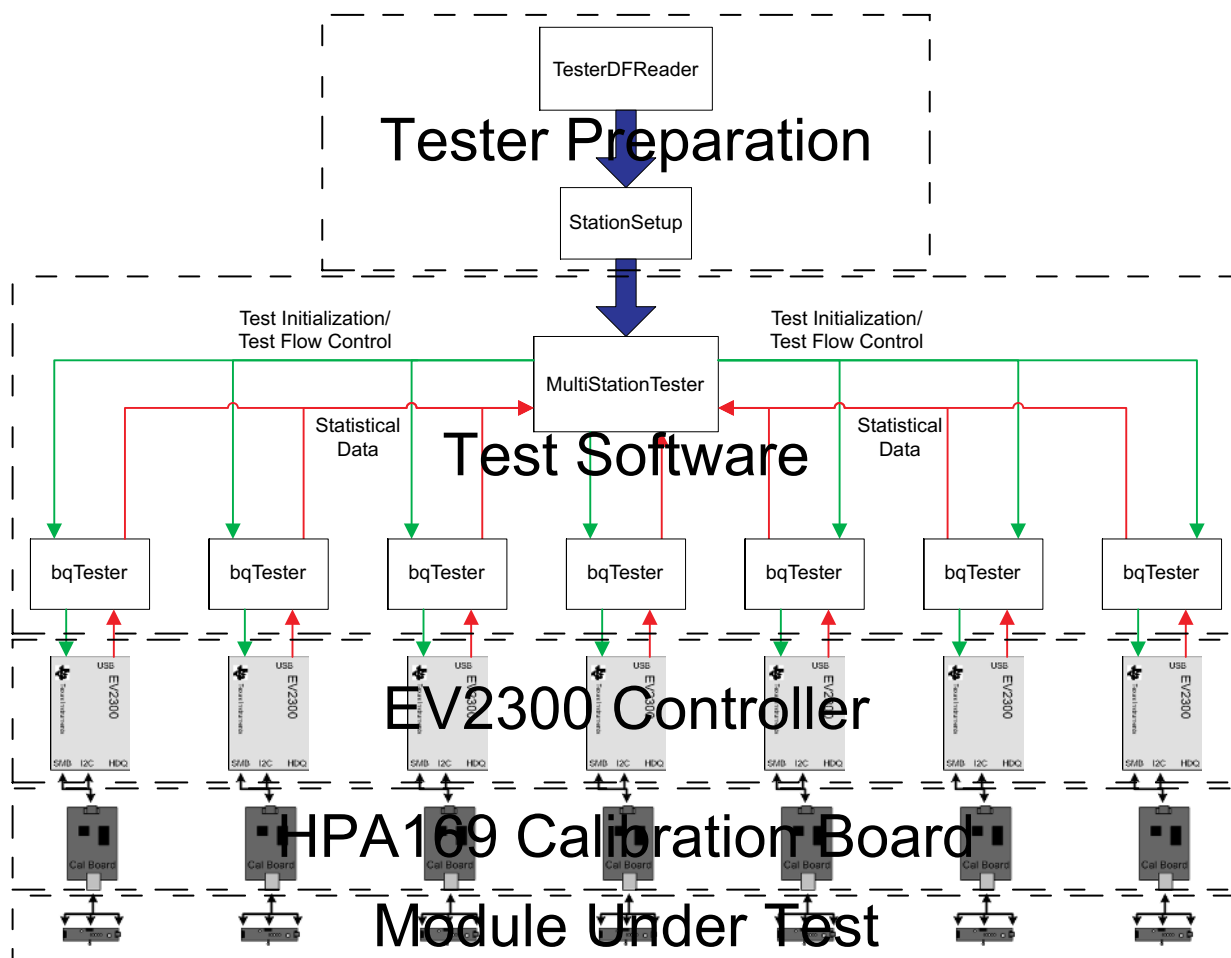

Figure 1. bqMTester Multi-Station Flow

2.1.1 bqMTester: Functionality

The bqMTester functional procedure is as follows:

1. First you must setup the tester. Install the software and connect all stations to the PC until there are drivers associated with each instance of the tester as explained in chapter 4
2. Then, after a *Golden* pack has been made as described in section 5, the data flash from that *Golden* pack is retrieved and stored to a *Golden Image File* using the TesterDFReader.exe program. This file has optimized data specific to the batteries used for this particular test run using bqMTester.
3. The next step is to run the StationSetup.exe file.
 - a. This program will first detect all stations and request names for those stations.
 - b. Next is a temperature probe setup screen where individual temperature probes are assigned to stations.
 - c. Then the program will request calibration specific data and the location of the golden image file so that data can be installed in all gas gauge modules to be tested.
4. Finally the MultistationTester.exe program is run. Here you will:
 - a. Update voltage, current, and temperature settings in the Update VTI screen to ensure that the voltage, current, and temperature data from the reference sources used to calibrate are as accurate as possible.
 - b. Start testing. Log data will be displayed on the log screens and stored to a file as setup in step 3.

2.1.2 bqMTester Multi-Station (bqMultiStationTester.exe): Configuration

bqMTester as a multi-station test application requires an HPA169, 2 wall brick power supplies (5V/4A and 24V/0.5A each with isolated grounds), and a user supplied Test Head for every test station. Each station will also require an EV2300 (purchased separately) with the firmware compatible with Multi-Station Testing support (denoted by a *USB Tester Ready* label on the top of the EV2300 as seen below):

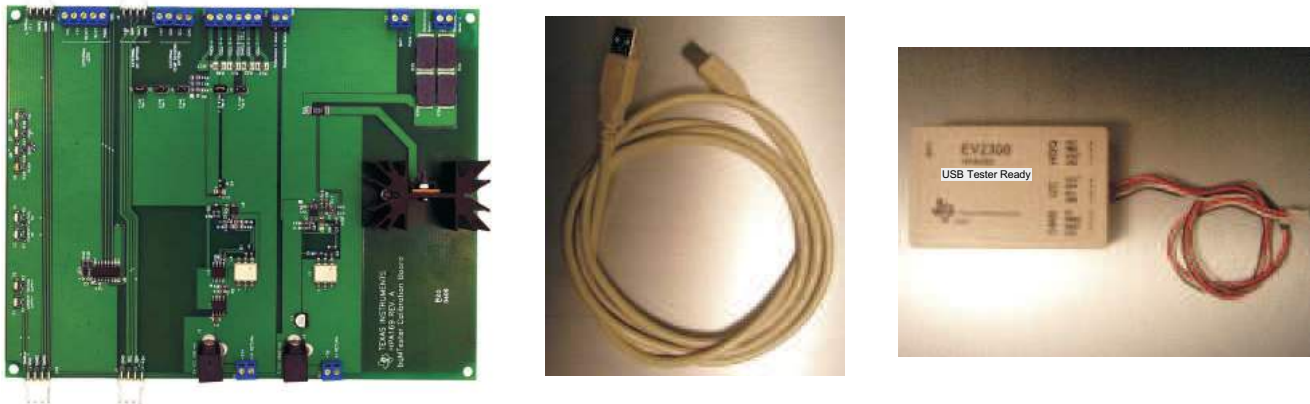
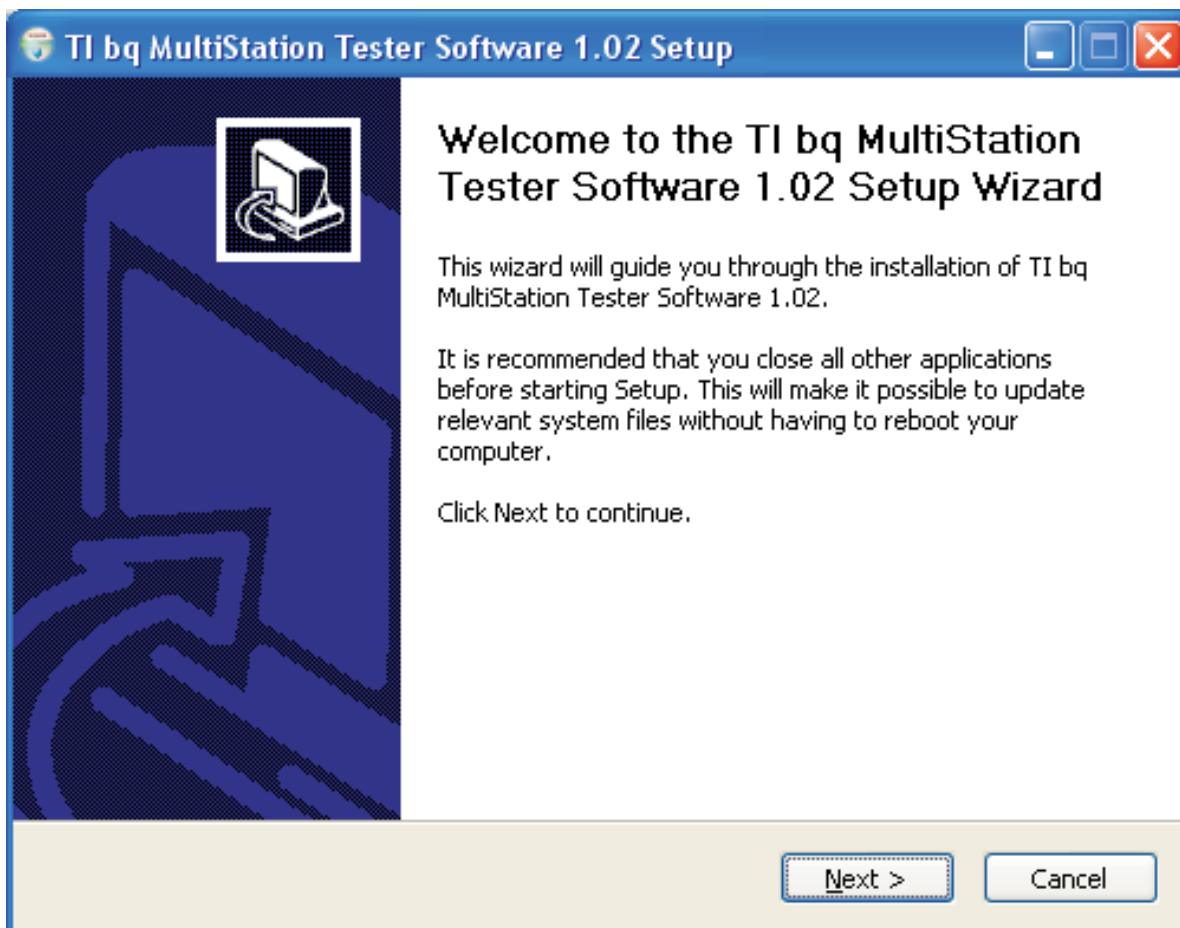

Figure 2. Included Hardware With bqMTester Kit

3 Software Installation

The **bqMultiStationTester102hSetupWDriver_supports701n702.exe** executable installs all required software, drivers, and DLL files for proper software operation (102h indicates the version of the software and may not represent the current version of the Impedance Track device). To install the software:

1. **Do Not** connect any EV2300s to the PC before installing software. If any are connected please disconnect them now.
2. It is recommended to check for software in the *bqMtester Tool Folder* on the www.ti.com web site. The Tool Folder is located at:
<http://focus.ti.com/docs/toolsw/folders/print/bqmtester.html>
3. If installing software downloaded from the above website then unzip the downloaded file into a temporary directory and go to **Start, Run**, and type:
C:\Yourdirectory\bqMultiStationTester102SetupWDriver.exe and click **OK** (replace *C:\Yourdirectory* with the location that you unzipped the file). Then go to step 6.
4. If installing software from the CD included in the bqMTTester kit then insert the bqMTTester CD into your CD drive.
5. Go to **Start, Run**, and type **D:\bqMultiStationTester102SetupWDriver.exe** (assuming D:\ is your CD player) and click **OK**.



6. Click **Next** at the welcome screen.

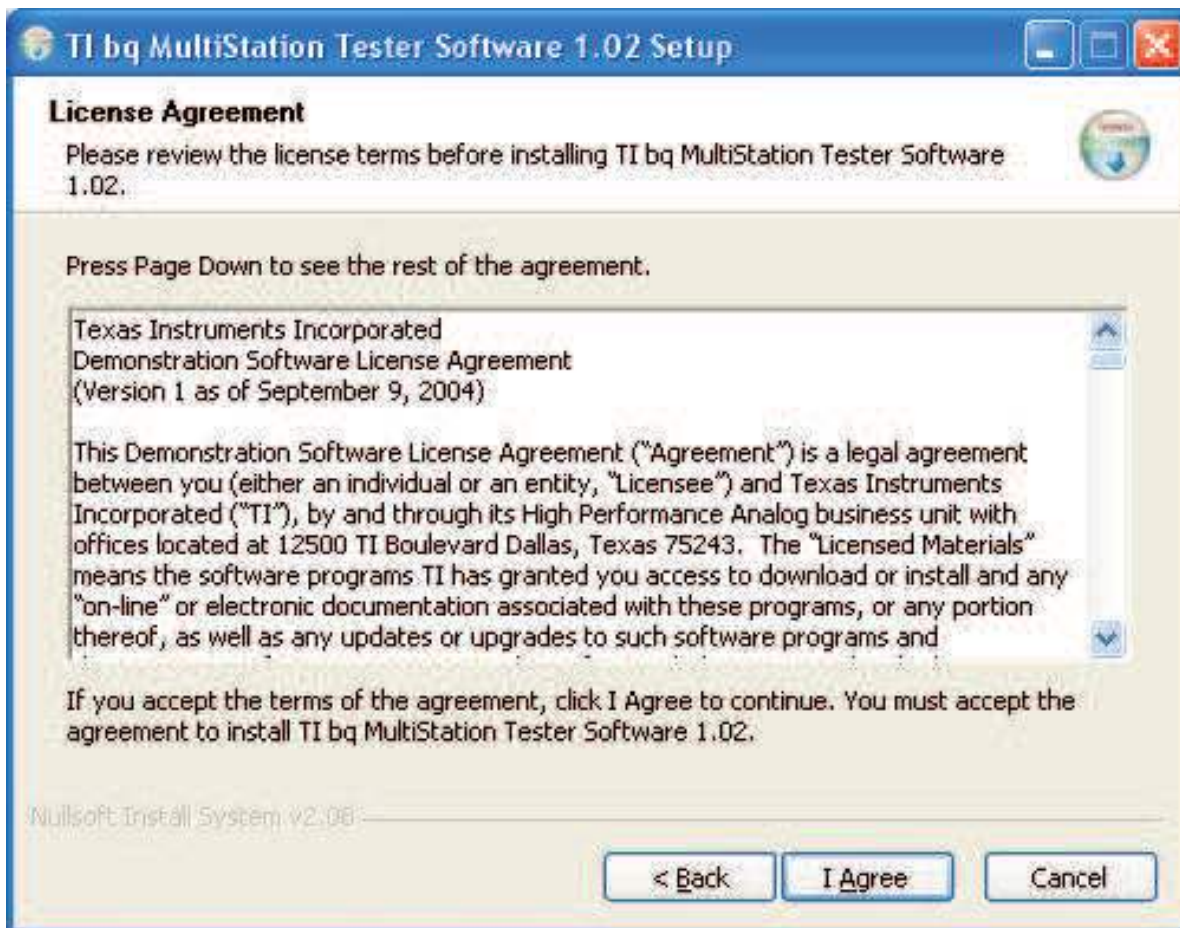

7. Read the License Agreement at the license agreement screen and click **I Agree** when are done if you agree with the terms, otherwise, click **Cancel** and exit the installation software.

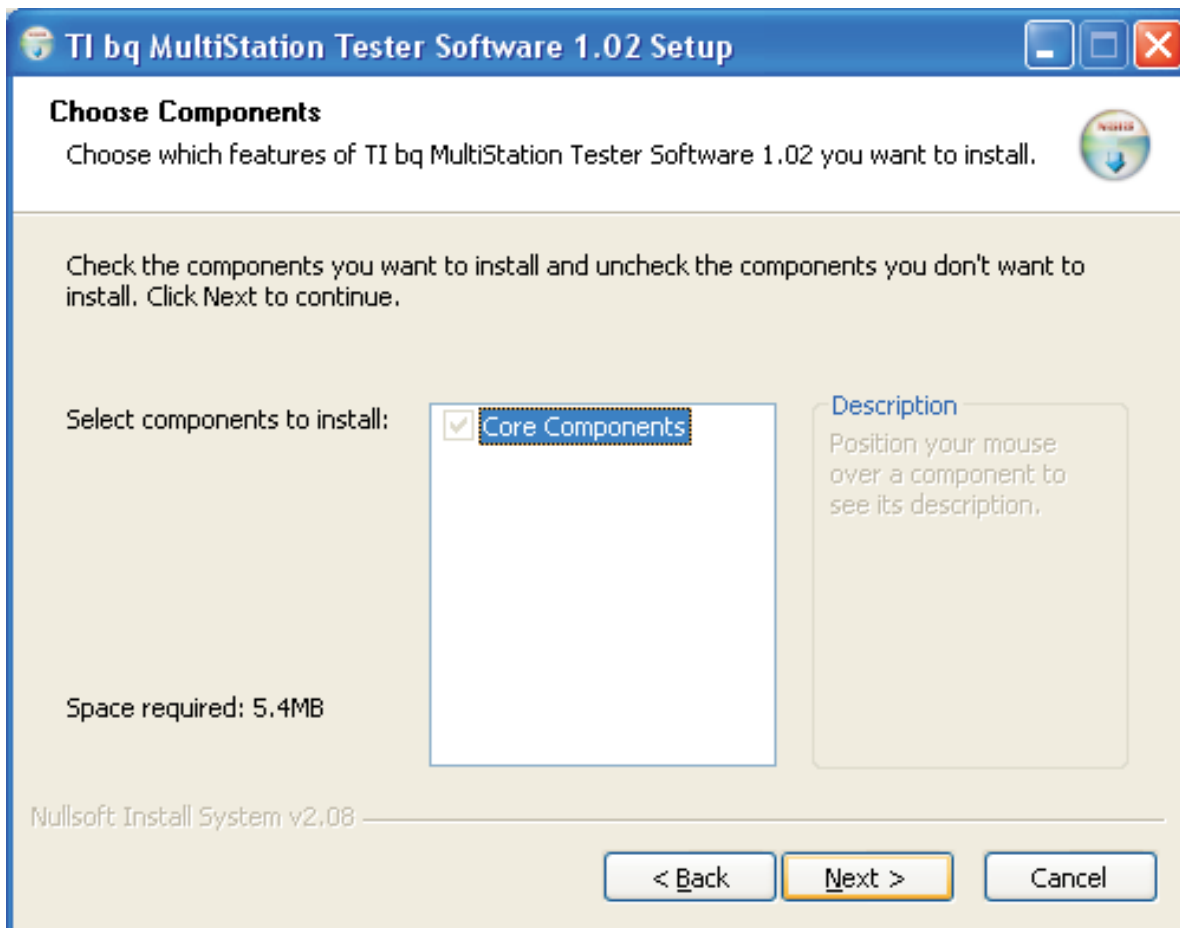

- Click **Next** at the Choose Components screen since there is only one option for the bqMTTester installation

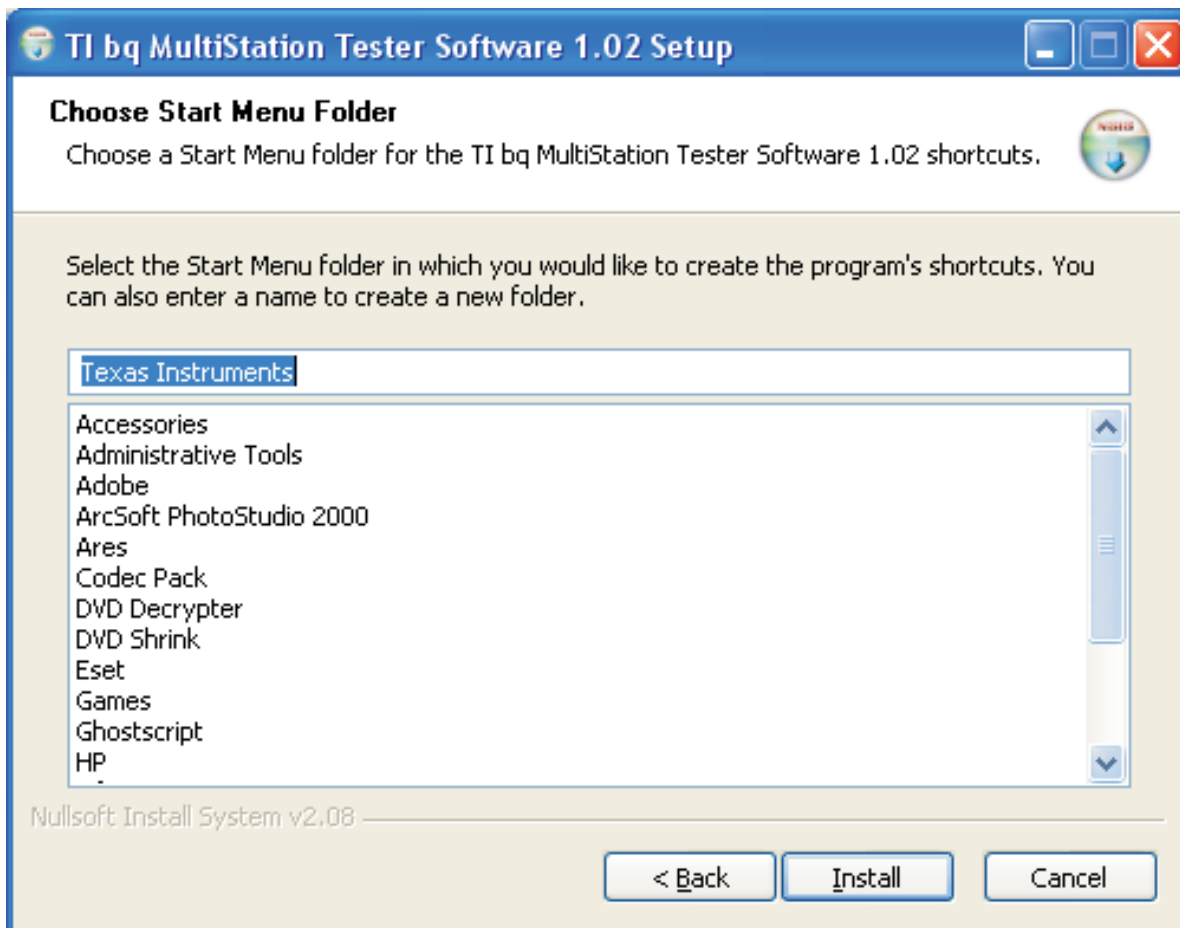

9. Choose the Start Menu Folder where you would like to install the bqMTTester associated shortcuts. Texas Instruments is the default destination. Then click **Install**.

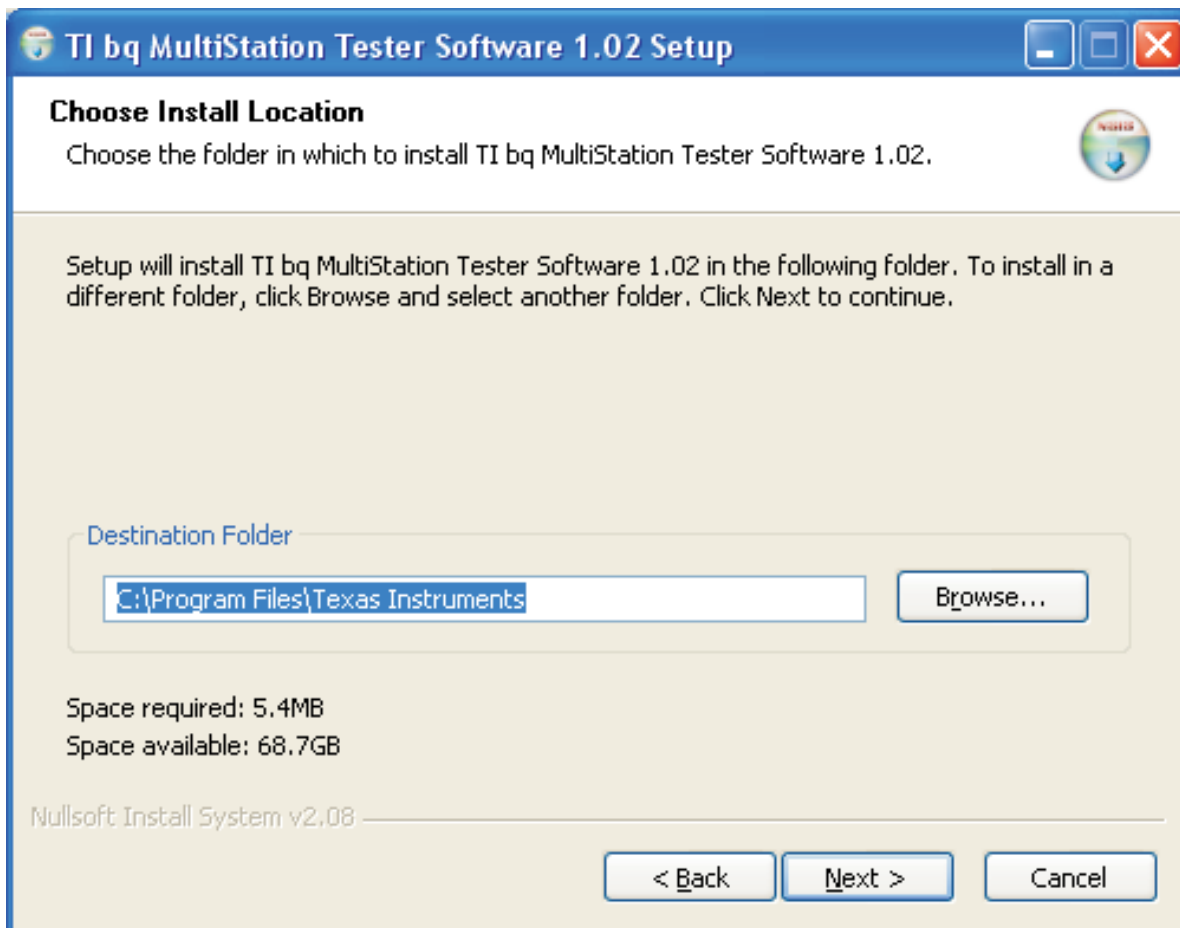

10. Select a destination folder where the software will be installed or use the default. Then click **Next** to start the installation.

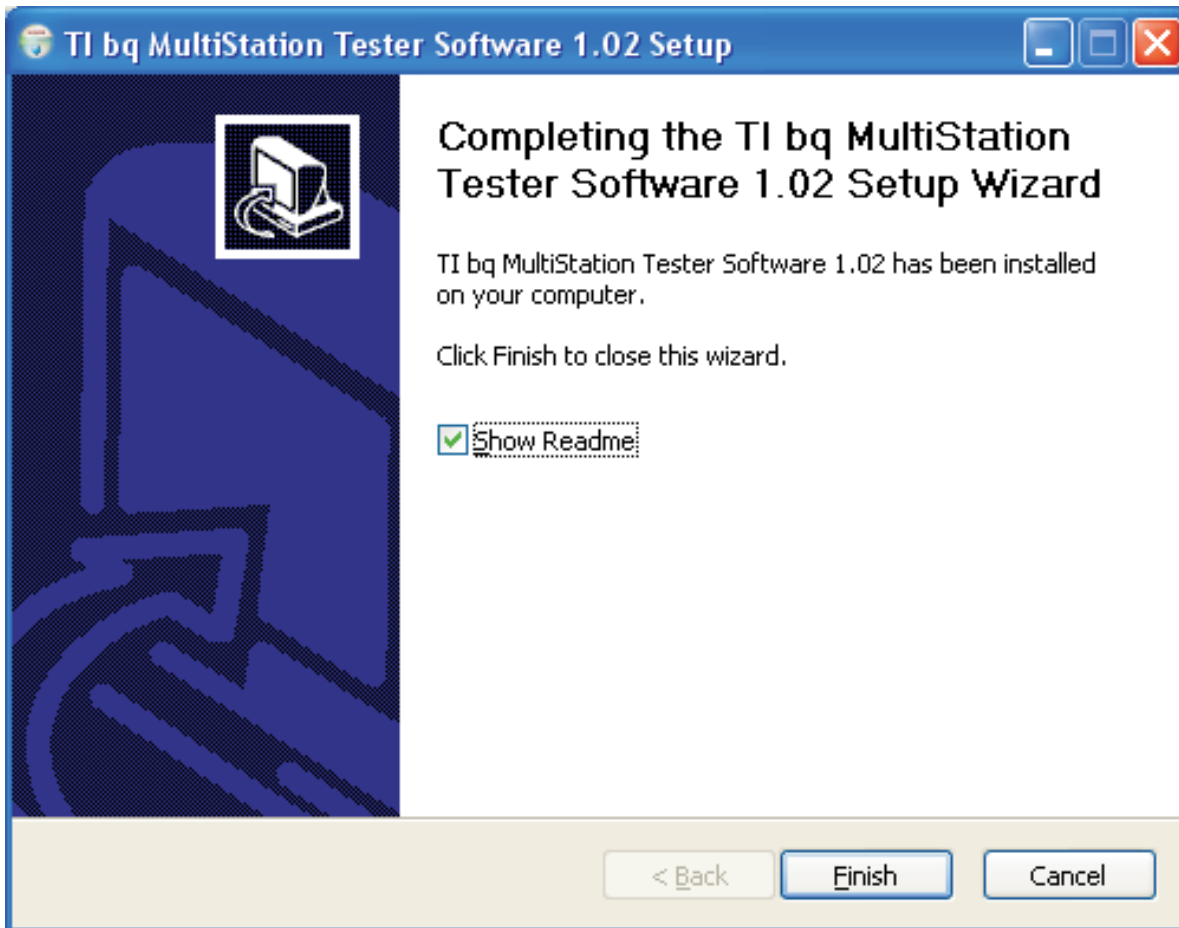

11. If at any time you are asked to reboot, then select **No** and continue.

12. When the software installation is complete click **Finish** to exit the software installation

All bqMTTester software is now installed on the PC. The EV2300 drivers now have to be associated with the USB ports that will be used with bqMTTester software as described in the following section.

3.1 EV2300 Driver to USB Port Association

There are 2 drivers associated with the EV2300. An instance of the 2 drivers must be associated with each EV2300 connected to the bqMTTester PC through any USB port. In other words, each USB port that has an EV2300 connected to it must have an additional instance of the 2 EV2300 drivers. That means for 12 stations of bqMTTester there will be a total of 24 drivers running at the same time. If an EV2300 is connected to the bqMTTester PC and the PC detects that it has not had an EV2300 connected to that particular USB port, then the computer will require the following procedure to associate a copy of the drivers for that USB port. To associate an instance of the EV2300 drivers to any given USB port:

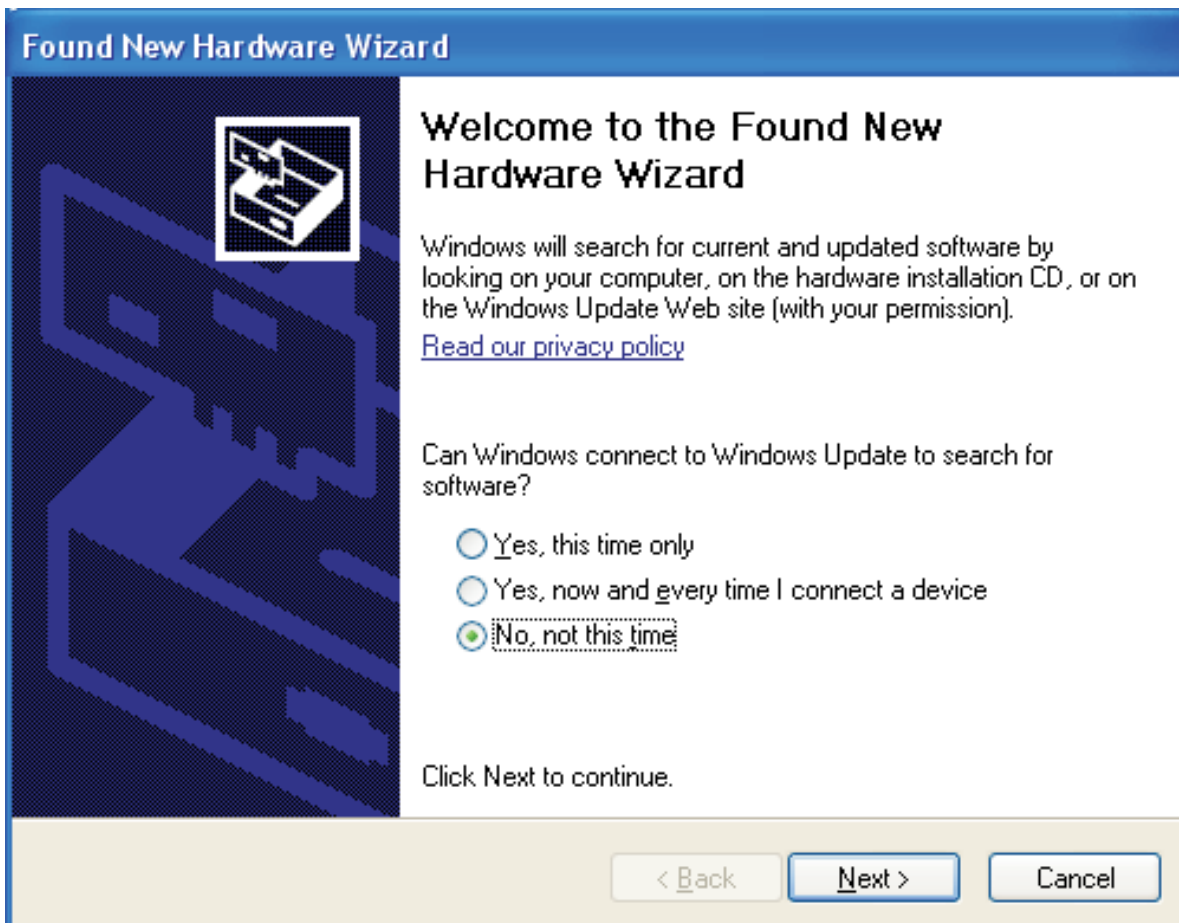

1. Connect an EV2300 to the bqMTTester PC. After a few seconds the Found New Hardware screen will appear. Select **No, not at this time** and click **Next**. If the first screen that appears does not look like this screen then proceed to the next step.

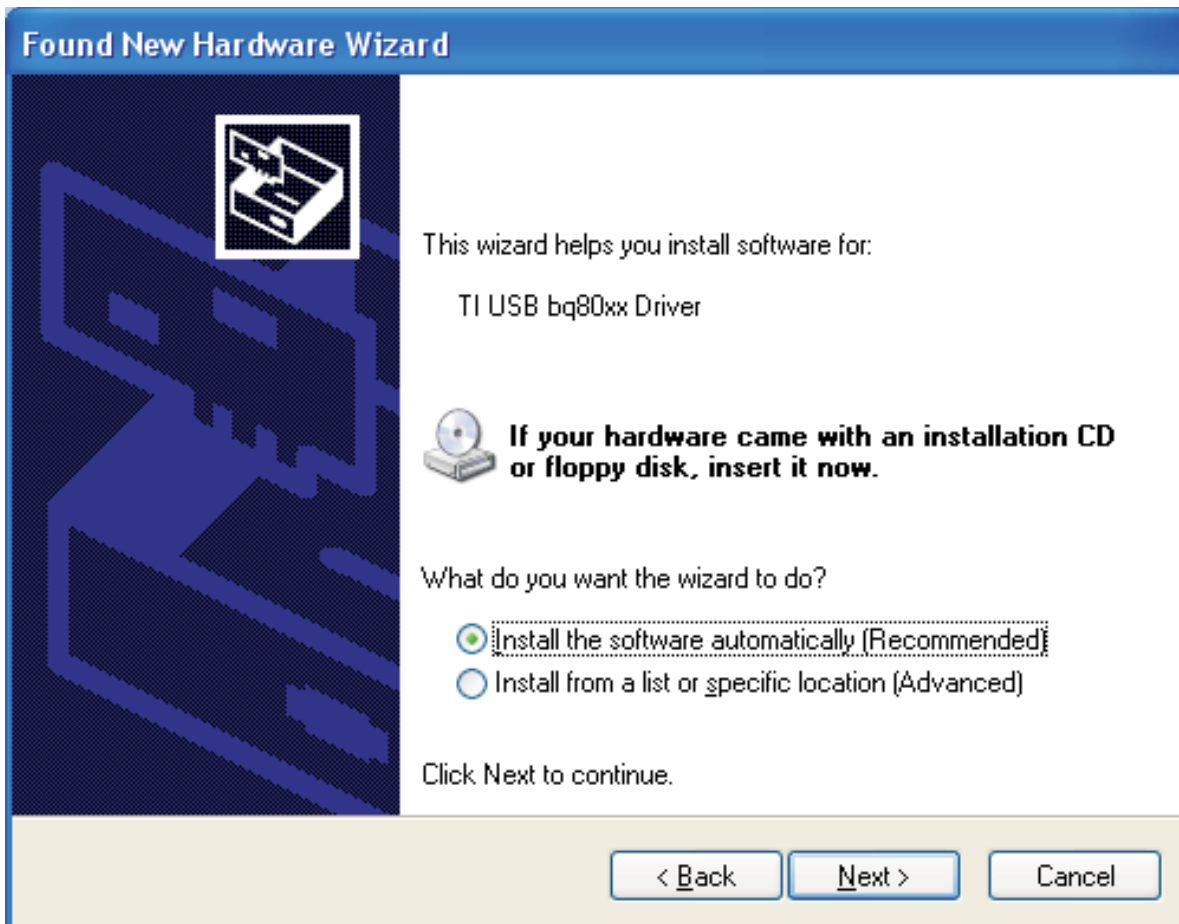

2. Select **Install the software automatically (Recommended)** and click **Next** on the next Found New Hardware screen for the first of the 2 drivers (TI USB Firmware Updater) required for this instance of the EV2300.
3. Click **Continue Anyway** on the Windows Logo Testing screen.

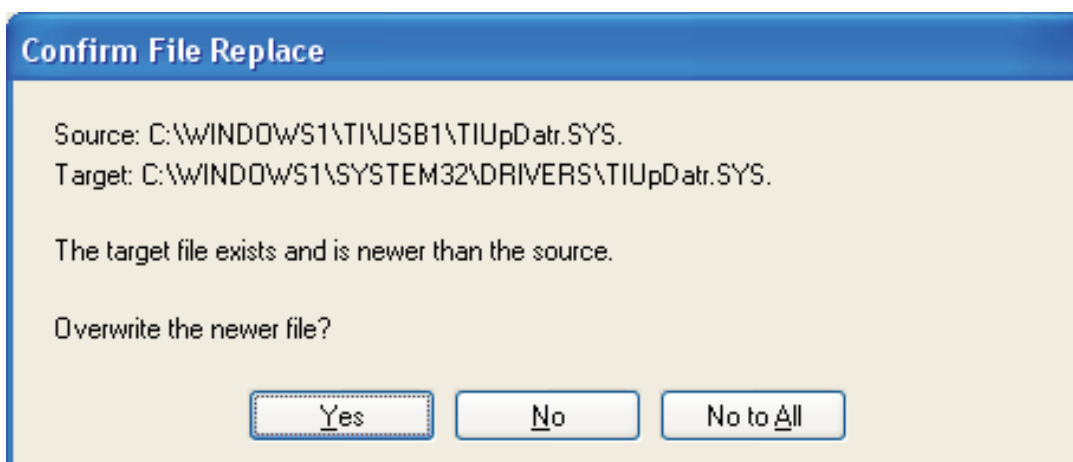

4. It is common for the next screen to be the Confirm File Replace screen. Click **No** to continue. If this screen does not appear then go to the next step.

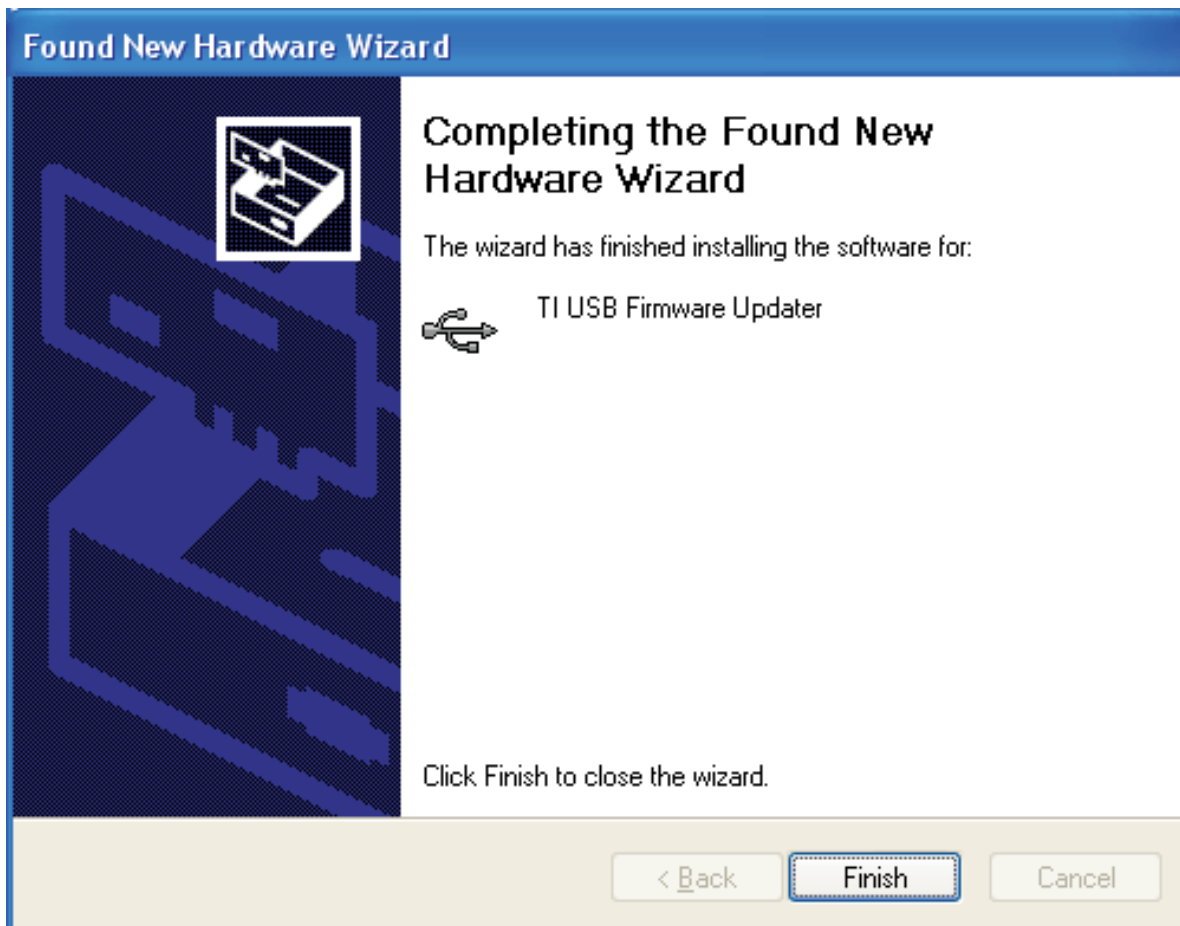

5. The TI USB Firmware Update driver is now installed for this instance of the EV2300. Click **Finish** to exit the driver install wizard.



6. After a few seconds another Found New Hardware screen appears to start the installation of the final driver for this instance of the EV2300. Select **No, not at this time** and click **Next**. If the screen that appears does not look like this screen then proceed to the next step.

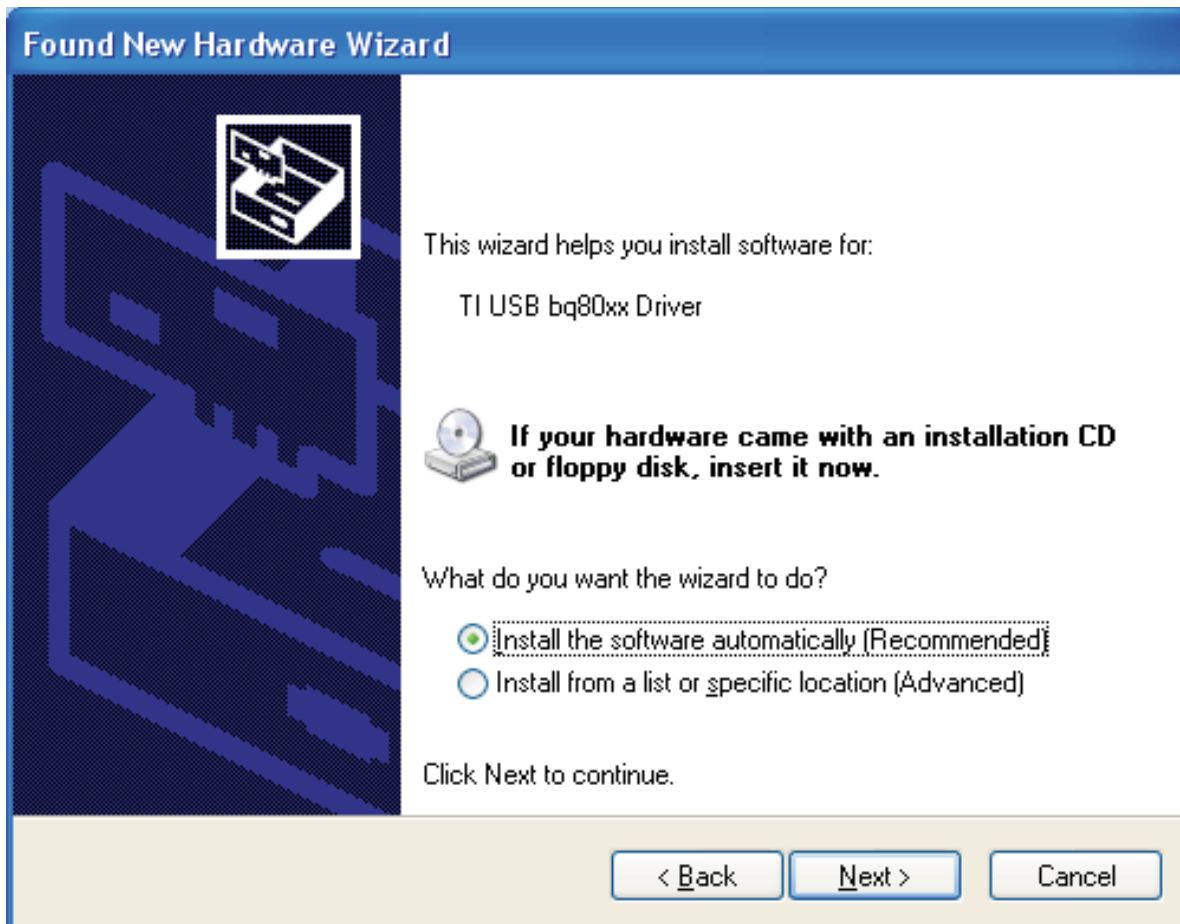

7. Select **Install the software automatically (Recommended)** and click Next on the next Found New Hardware screen for the second of the 2 drivers (TI USB bq80XX Driver) required for this instance of the EV2300.



8. Click **Continue Anyway** on the Windows Logo Testing screen.

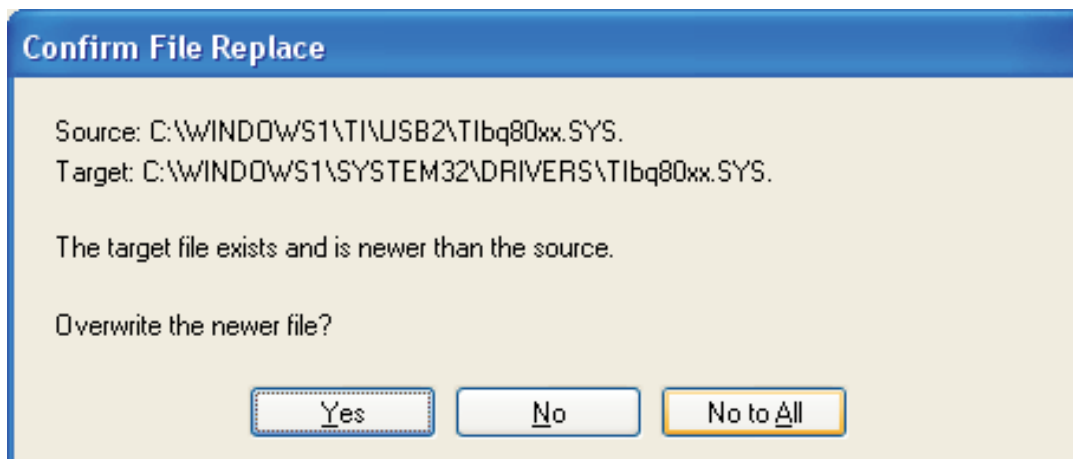

9. It is common for the next screen to be the Confirm File Replace screen. Click **No** to continue. If this screen does not appear then go to the next step.

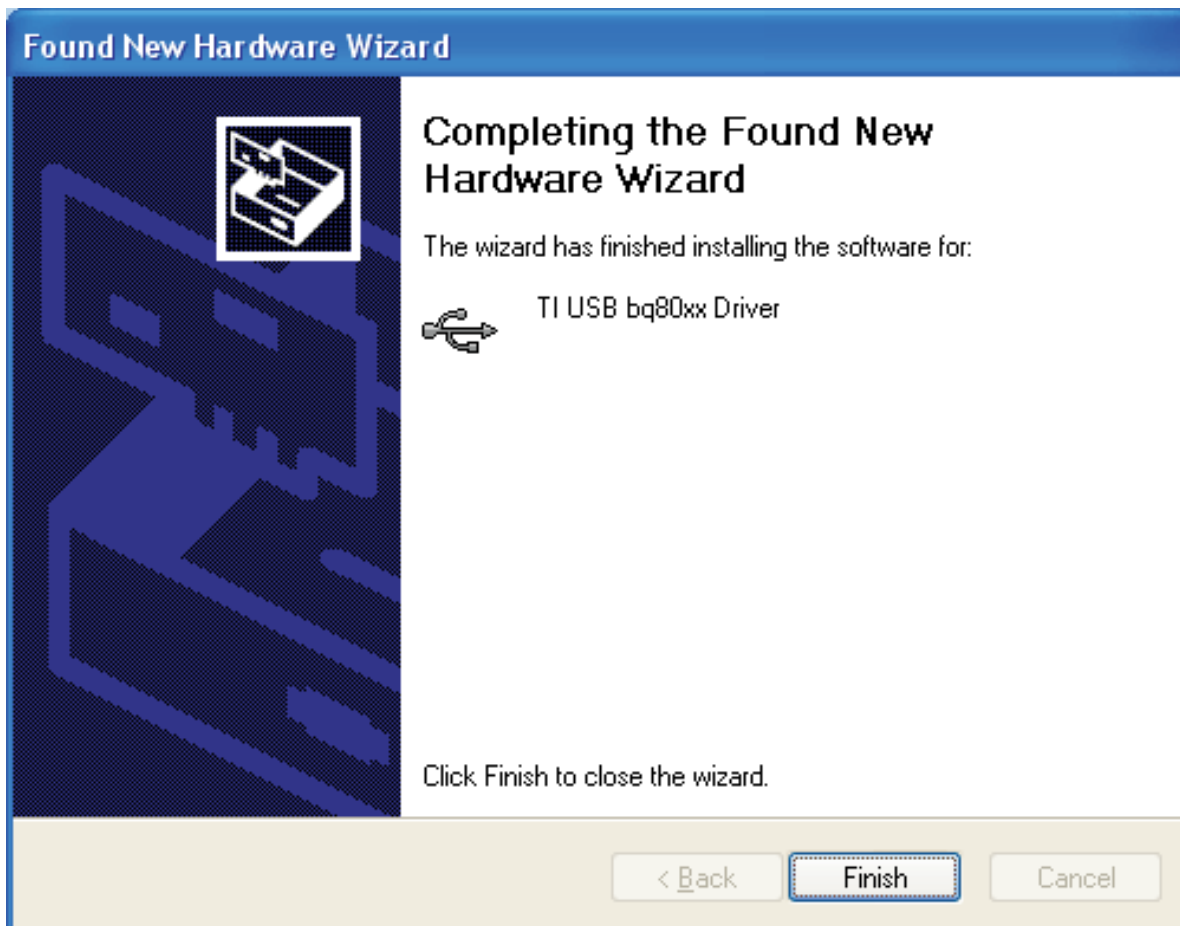

10. The TI bq80XX Driver is now installed for this instance of the EV2300. Click **Finish** to exit the driver install wizard.

At this point the installation of 1 instance of the EV2300 on one USB port is complete. To install more EV2300s to the bqMTester PC then repeat the install process from step 1 above for every instance of EV2300 required to a maximum of 12.

The driver installation process of each instance of EV2300s should only need to be done 1 time. After this the only reason it would be required is if the orientation between USB ports and EV2300s change. This could happen if a USB HUB position is changed, a USB hub is installed, or if an additional EV2300 is installed.

USB hubs can be used to accommodate stations for the bqMTester. It is recommended not to exceed 7 Ev2300/Test Stations per USB hub and that USB hubs not be nested. It is possible stations will not install with nested USB hubs. It is also recommended that the USB hub be USB 2.0 compliant and capable of 1.0A of output current.

4 Setup

4.1 ***Creating the "Golden" Image File (mandatory procedure): for bqTester (Single Station Testing) and bqMTester (Multi-Station Testing)***

After engineering development has been completed, a *golden* data flash image file must be made from an *Engineering Perfect* module. This *Golden Image* file will be used as a default to program the Static Data Flash constants in all the bq20zXX based smart battery modules. It is very important that this process is completed. If it is not then the impedance track algorithm may not function correctly.

This chapter assumes familiarity with Texas Instruments evaluation software for the bq20zXX modules since it was most likely used during the engineering development phase of this project. If it is not familiar then refer to the *bq20z80-001 EVM tool folder* that includes a user guide for the EVM, application notes, and the latest EV software:

<http://focus.ti.com/docs/toolsw/folders/print/bq20z80evm-001.html>

4.1.1 Creating the "Engineering Perfect" Battery Pack:

It is assumed at this point that an engineering prototype battery pack is complete and that all static data flash constants have been reviewed and verified for a particular battery pack model. Static data flash is all data flash constants that are not battery pack specific.

Static Data Examples: Static data examples are Charging Voltage, Impedance Track resistance tables, and QMAX settings. Examples of non-static data include serial number, date, and calibration data are all examples of data that is not static.

It is also assumed that this Engineering Perfect battery pack was created using the correct chemistry support SENC file. For more information on this please refer to the Multi-Chemistry Support application note:

Support of Multiple Li-Ion Chemistries w/Impedance Track™ Gas Gauge

This can be found at:

<http://focus.ti.com/analog/docs/techdocsabstract.tsp?familyId=412&abstractName=slua372>

Now the impedance track data must be verified. This data must be updated and accurate so that all battery packs produced have accurate impedance track tables in data flash *right out of the box*. To ensure that the impedance track tables are optimized, complete the following steps:

1. Using an EV2300 and the EV software appropriate for the device being used in this application (ex: bq20z70, bq20z80, or bq20z90), ensure that the data flash locations **Qmax Cell 0–Qmax Cell 3**, and **Qmax Pack** have good estimates in them for the battery pack capacity. This information can be derived from the Battery cell manufacturer data sheet. Also note that if more than one cell is connected in parallel then the capacity will increment by one cell capacity for every cell in parallel. For example, if a single-cell data-sheet capacity is 2400mAh, and 3 parallel cells are used, set each value to $2400 \times 3 = 7200\text{mAh}$.
2. Charge the pack to full. If it does not charge then ensure that impedance track is enabled by sending data 0x0021 to SMBus command 0x00 (*Manufacturer Access*).
3. When the pack is full, remove the charger and let the pack relax for 2 hours.
4. Discharge the pack to minimal device acceptable voltage (also set as *Term Voltage* flash constant), at a typical rate for the target application. The exact rate is not critical.
5. Let the pack relax for at least 5 hours
6. Repeat steps 2 through 5 for maximum accuracy.
7. Connect the pack to the EV software, go to the data flash screen, and ensure that **Update Status** is 0x06.
8. The battery pack is now *Engineering Perfect*.

4.2 Creating Golden GG File From Engineering Perfect Battery Pack

A GG file needs to be created with all the data from the *Engineering Perfect* battery pack that will be used in creating the *Golden Image* File. The purpose of this GG file is to insure that we get all the non-reserved data saved so that we can install it back into the module after the battery pack is put back into the original state with a new SENC file in the next chapter. We also want to change *usage* data to original values so all programmed battery packs do not report that they have been used. To make this Golden GG file, do the following:

1. Insure that the *Engineering Perfect* battery pack is still connected to the EV2300 and that the EV software for the applicable device is open.
2. Go to the Data Flash screen in the EV software and click the **Read All** button.
3. Select the *File* pulldown menu, click **Export**, and chose a (*.gg) file name for saving the pre-learned defaults (example: optimized.gg).

4. Open the saved GG file from step 3 in a text editor such as Notepad, and change the value of *Update Status* from 06 to 02, which indicates that the parameters are learned but the Impedance Track™ feature is disabled (as should be the case for a new pack prior to calibration).

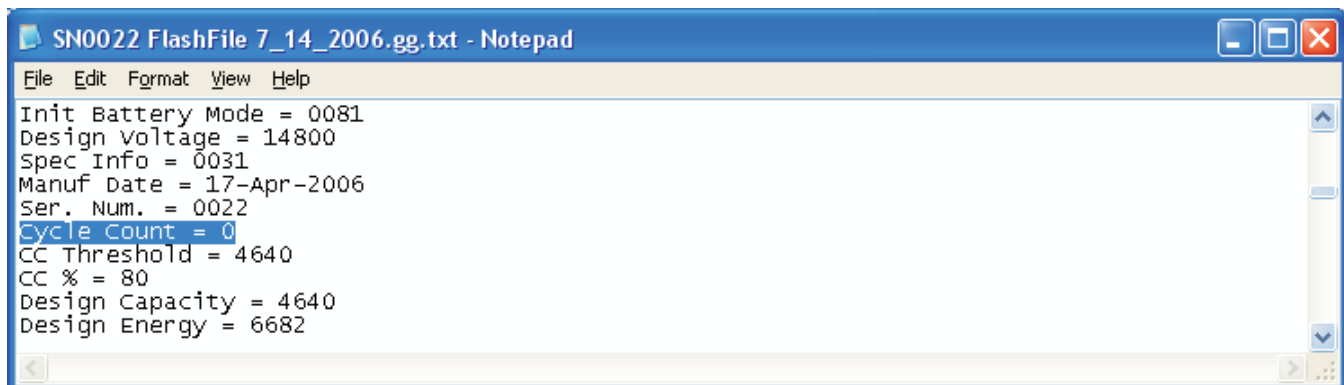

Figure 3. Cycle Count Modification in GG File Using Notepad

5. Also Reset the *Cycle Count* field to 0 as shown in [Figure 3](#).
6. Then save the file. This file will be used below.

4.3 Installing the Original SENC File With Correct Chemistry Support

It is assumed that the proper Chemistry Support SENC file has been determined for this application during the Engineering and Development Phase of this project. For most applications (LiCoO₂/graphitized carbon chemistry), the default SENC file for the applicable device (ex: bq20z80, bq20z90, or bq20z70) will be used. For more information on multi-chemistry support please refer to the Multi-Chemistry Support application note:

Support of Multiple Li-Ion Chemistries w/Impedance Track(TM) Gas Gauge

The following instructions explain how to install the original chemistry supported SENC file into the *Engineering Perfect* battery pack. Do not worry about losing all the static data from this pack because it was stored in the previous chapter.

1. Go to the product folder for the device being used in this application.
Some Examples:
 - a. For the bq20z70 go to: *bq20z70 Tools and Software Section*
 - b. For the bq20z80 go to: *bq20z80 Tools and Software Section*
 - c. For the bq20z90 go to: *bq20z90 Tools and Software Section*
2. Click on the Multi-Chemistry Support Software zip file pertaining to the device being used:
Some Examples:
 - a. For the bq20z70 go to:
bq20z70-V101 Multiple Li-Ion Chemistries Software
 - b. For the bq20z80 go to:
bq20z80-V102 Multiple Li-Ion Chemistries Software
 - c. For the bq20z90 go to:
bq20z90-V102 Multiple Li-Ion Chemistries Software
3. Download the applicable zip file and extract to a temporary directory. An example would be C:\Temp\sluc058.zip
4. Insure that the *Engineering Perfect* battery pack is still connected to the EV2300 and that the EV software for the applicable device is open. Then go to the Pro screen in the EV software.

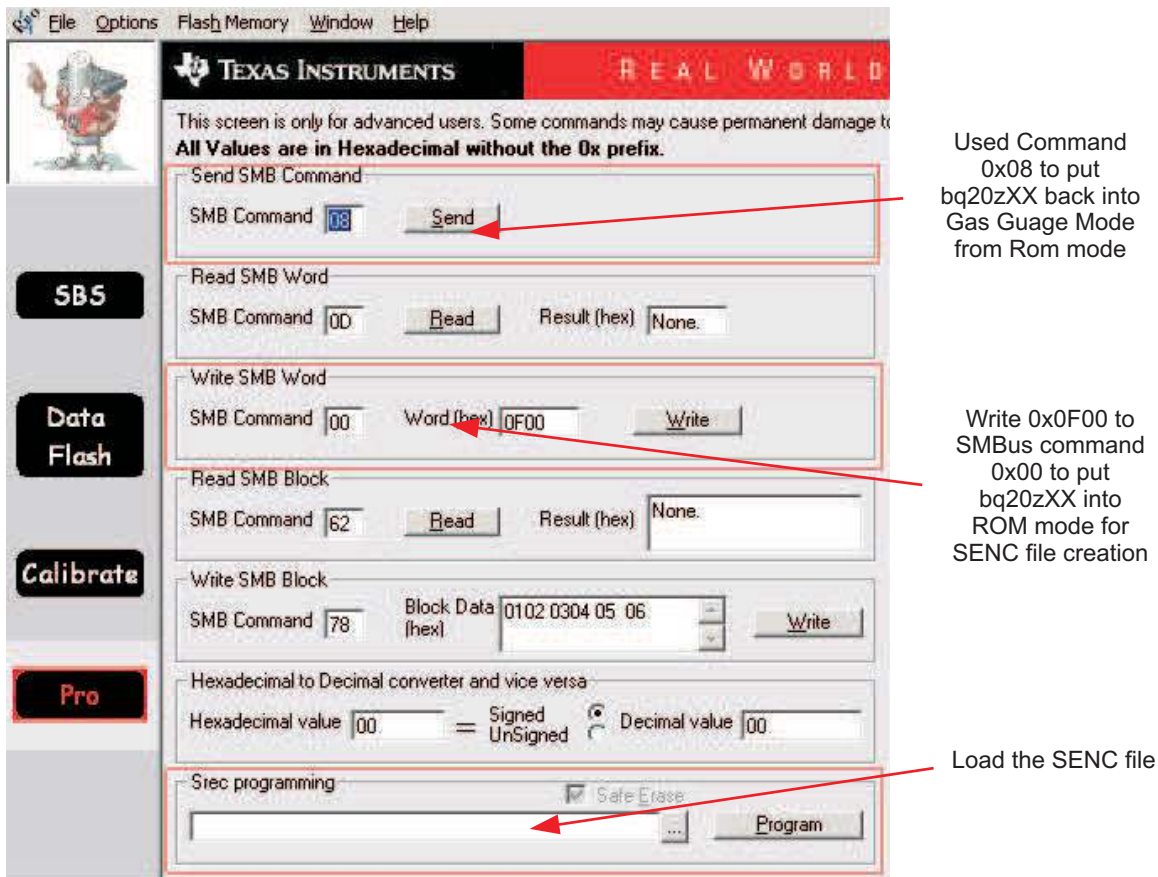



Figure 4. EV Software Pro Screen

5. Ensure that *Write SMB Word* frame has the SMBus Command set to 0x00 and the SMBus Word set to 0x0F00. If they are not then change them.
6. Then click Write. This puts the bq20zXX module into ROM mode to prepare for writing the SENC file created in the section above.
7. Write the SENC file to the *Engineering Perfect* pack by clicking the browse () button in the *Srec programming* frame.
8. In the file manager that pops up, locate and select the previously saved SENC file created previously in the above section.
9. Then click the **Program** button. The software will indicate when finished.
10. After it finishes writing then ensure that the **SMB Command** is 0x08 in the *Send SMB Command* frame. If it is not then change it to 0x08.
11. Then Click the **Send** button. This puts the bq20zXX back into Gas Gauge mode. Your factory default SENC file is now loaded.

4.4 Creating the Golden Image File

The final step in this process is creating the *Golden Image* file. This file will include all the static data in the data flash that is constant from one smart battery module to the next. It also has all the reserved data and *usage* data set to default states to insure that all new packs start out in a new state. This process is mandatory for new designs and is required for using both single station testing (bqTester.exe) and for Multi-Station Testing (MultiStationTester.exe). Without this process the Impedance Track Algorithm may not function properly. Follow these steps to create this file:

1. Insure that the *Engineering Perfect* battery pack is still connected to the EV2300 and that the EV software for the applicable device is open. Then go to the Data Flash screen and open the *File*

- pull-down menu and select **Import**.
- 2. Then in the file manager that pops up, locate and select the Golden GG file created in the above section and click the **Write All** button.
- 3. The *Engineering Perfect* battery pack now has all *Golden* data in it. The next step is to retrieve that data into a *Golden* image file.
- 4. Run the Data Flash reading software in the bqMTester suite by double clicking the TesterDFReader.exe file in the directory where the software was installed.

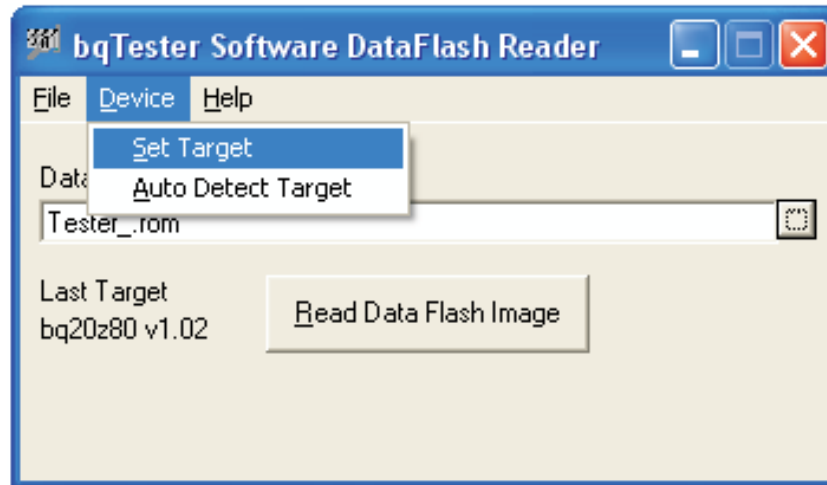



Figure 5. TesterDFReader.exe Software

- 5. Select the device type of device being read from the *Device* pull-down menu.
- 6. Type in a complete path and file name with a .rom extension in the dialog box or click the browse button ().
- 7. Click the *Read Data Flash Image* button. This will cause the software to read the data flash information from the bq20zXX based smart battery module and store it in this file.

This .rom file is now the *golden* data flash image file which will be used to program all other similar bq20zXX based smart battery modules in the production process.

Need to add description of Seal Pack check box. GTG 11-22-05

5 Multi-Station Testing (MultiStationTester.exe): Individual Station Interface Connections

bqMTester requires that the latest version of the EV2300 USB-Based PC Interface Board for Battery Fuel Gauge Evaluation interface from Texas Instruments be installed and running properly.

The HPA169 calibration board should be connected as shown in [Figure 6](#). All four pins (Vout, SDA, SCL, and GND) on the I2C connector of the EV2300 should be connected to the calibration board I2C connector. The SMBus connector of the EV2300 should have the SMBD, SMBC, and GND connected between the EV2300 and the module under test.

It is VERY important that the 2 ground connections connected to 1N of the module under test be connected as close to the module as possible. This connection is very critical to ensure accurate voltage calibration.

Connect an isolated 5V/4A wall brick power supply to the bottom power connector and an isolated 24V/0.5A wall brick power supply to the top power connector. It is VERY important that these power supplies be ground isolated. There should be no ground plug on the wall connection. Our recommended part numbers for these supplies are:

24 volt supply: CUI Inc model no. EUA-101W-24

5 volt supply: CUI Inc model no. EPA-201DA-05

The Jumpers in [Figure 6](#) are setup for a 4 cell module test. To Test 3 cells, first remove all jumpers. Then install a jumper at J7 labeled 1, 2, or 3 Cell and another jumper at 3 Cell. For a 2 cell application, remove all jumpers and then install a jumper at 1 or 2 Cell and another jumper at 2 Cell. While the HPA169 Calibration board includes an on board temperature sensor, it is recommended that you use external temperature sensors for the most accurate temperature calibration. For using an external temperature sensor use the TI TMP100 and connect per [Figure 7](#). The Software will distinguish between the on board temperature sensor and any external temperature sensor because the on board sensor has I2C address 0x94 while the external temperature sensor is I2C address 0x90.

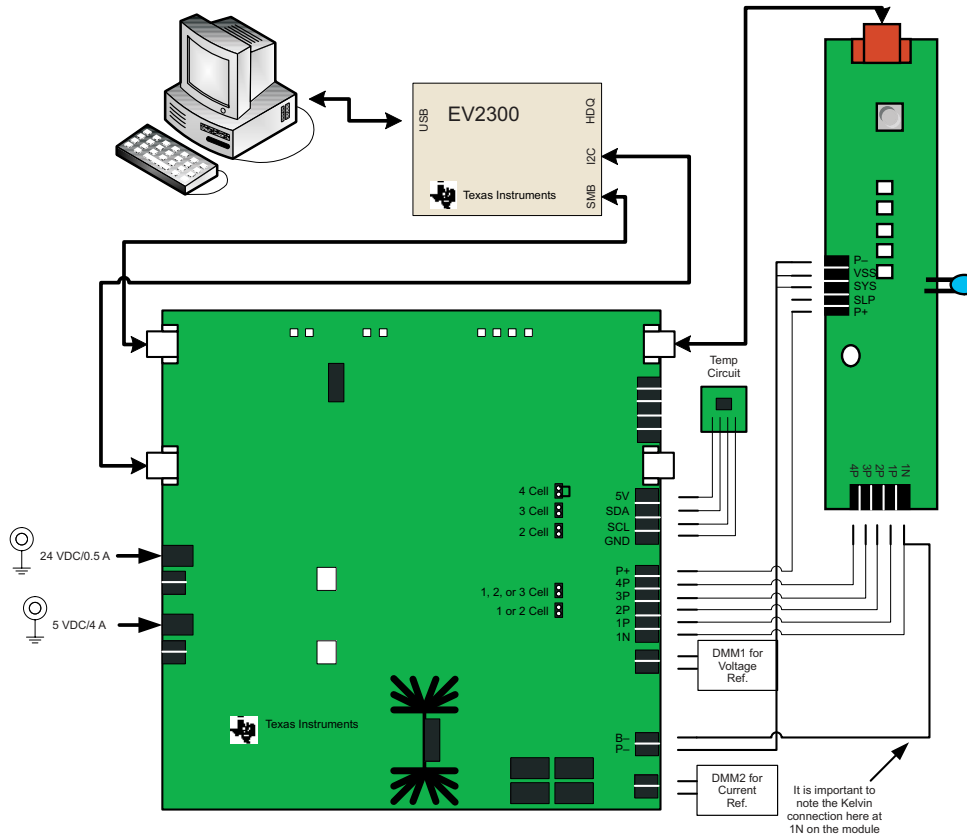

Figure 6. One Testing Station: EV2300/HPA169 Cal Board/Smart Battery Module Connections

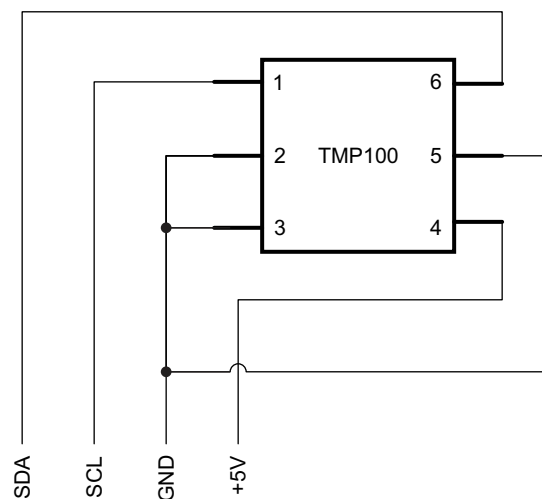

Figure 7. External Temperature Sensor Connection

6 Multiple Station Setup

When setting up for the first time or adding testing stations to the PC, run the StationSetup.exe program to identify and setup the configurations for all the test stations connected to the PC. Follow these steps to prepare all stations:

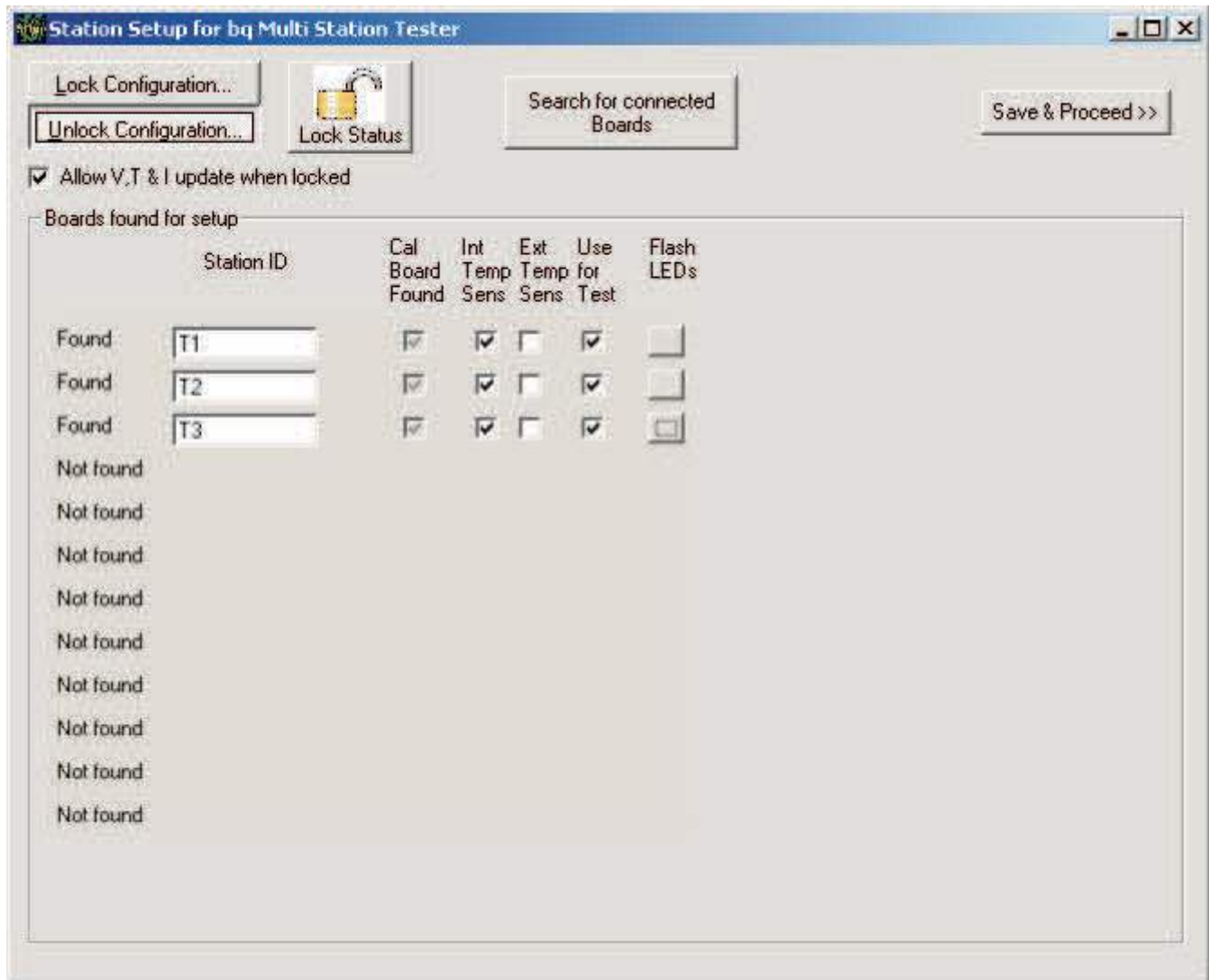

Figure 8. Station Setup Program

1. Connect all the stations to the PC. Up to 12 stations are supported. An 8 station configuration is shown in [Figure 9](#).
2. Unlock the Station Setup program by clicking the *Unlock Configuration* button. You will be prompted to input a password. The default password is *bq20z80* without the quotes. Click **OK** next to the password input field after typing the password. When relocking the software you will be prompted to change the password.
3. Click the *Search for Connected Boards* button so the software can detect all the stations you have connected to the PC. The software will detect and display all stations connected to the PC. If a textbox appears with a message saying *Detected EV2300* with an old firmware version. Update the EV2300 to version 3.1k or later. If required, contact TI for assistance.
4. Type a unique text name in the *Station ID* field to help identify each station with a simple name.
5. Select which stations will have their internal or external temperature sensors available for use for calibration with the *Int Temp Sens* or *Ext Temp Sens* check boxes. If neither internal nor external are

- selected then that station will be required to either use a temperature probe from another station or manual input of the temperature.
6. Select the *Use for Test* checkbox to enable a station for use during testing. If the “Use for Test” is deselected then that station will be disabled and will not perform testing. A disabled station’s temperature probe will be available to other stations however if it is selected from step 5 above.
 7. Clicking the “Flash LED” button for each station will cause the corresponding calibration board to flash its LEDs and enable the current and voltage power supplies. This is useful for testing the power supplies and for identifying the corresponding hardware for each station.
 8. Click the **Save and Proceed** button.

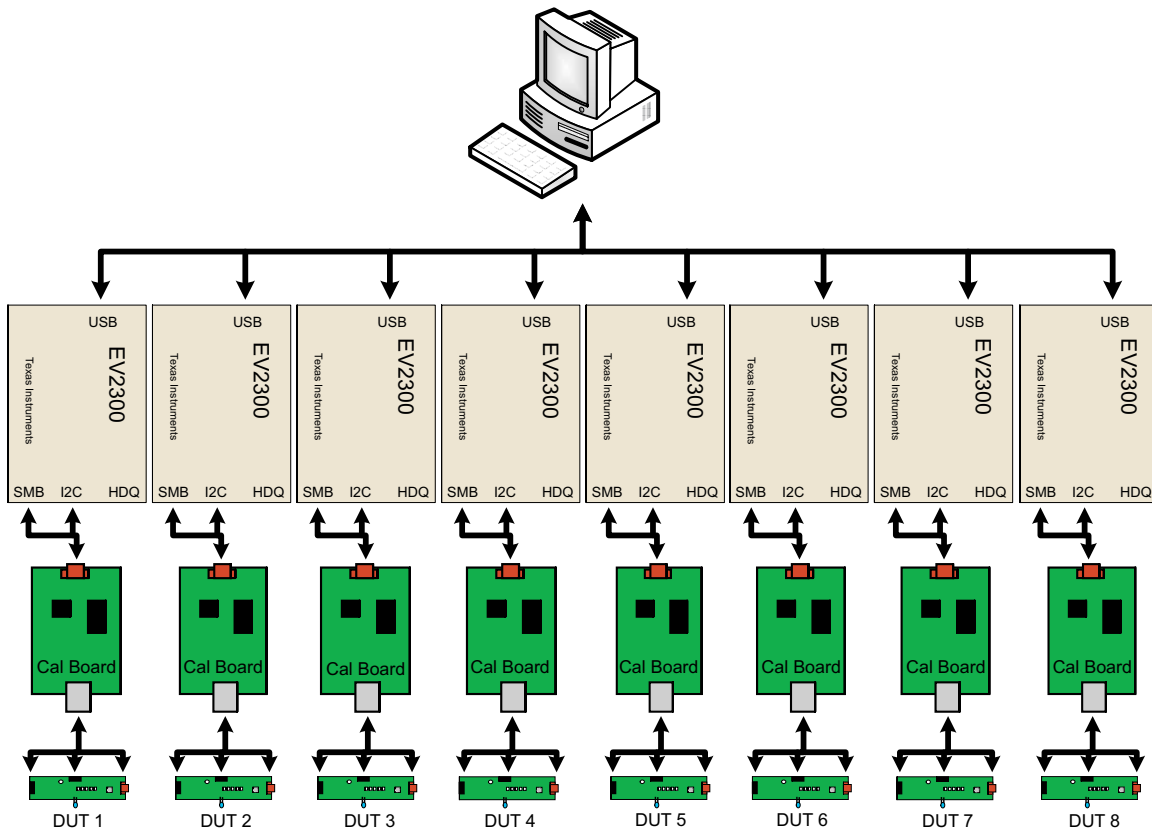

Figure 9. Multi-Station Setup

6.1 Temperature Probe Selection

Clicking the **Save and Proceed** button brings up the Temperature Probe Selection window. This window is used to configure the temperature probes. For each station there is the option of selecting either:

1. *No Tracking – Use entered value*
2. The temperature probe measurements from any of the stations that had their temperature probes enabled from the *Use for Test* checkbox selection on the first screen.

For example: If only one temperature probe is required for all channels and it is to be an external temperature sensor and not the one installed on the calibration board for a station named *Station1* then the user would do the following:

1. Start the StationSetup.exe program.
2. Unlock and click the *Search for boards* button.
3. Name all stations using a unique Station ID but name one station *Station1* so that it can be referenced in the next couple of steps
4. Select *Ext. Temp Sense* checkbox for *Station 1*. All other stations select *Int Temp Sense*.

5. Select *Use for Test* checkbox for *Station 1* and all other stations.
6. Click *Save and Proceed*.
7. On the Temperature Probe Selection screen select *External Probe: Station1* for all the stations available in the list.
8. Click *Next*.
9. Configure global screen as described in section chapter 8

Now all stations will use the probe connected to the External Temperature Probe Terminal Block for the station named *Station1*.

6.2 Global Configuration Window

Clicking the *Next* button from the Temperature Probe Selection window brings up the Global Configuration window as shown in [Figure 10](#). Here, all data that is *Global* to all stations connected to the PC can be configured. In this window, all numeric values are specified in signed decimal except for the serial number field which is unsigned with a max value of 65535.

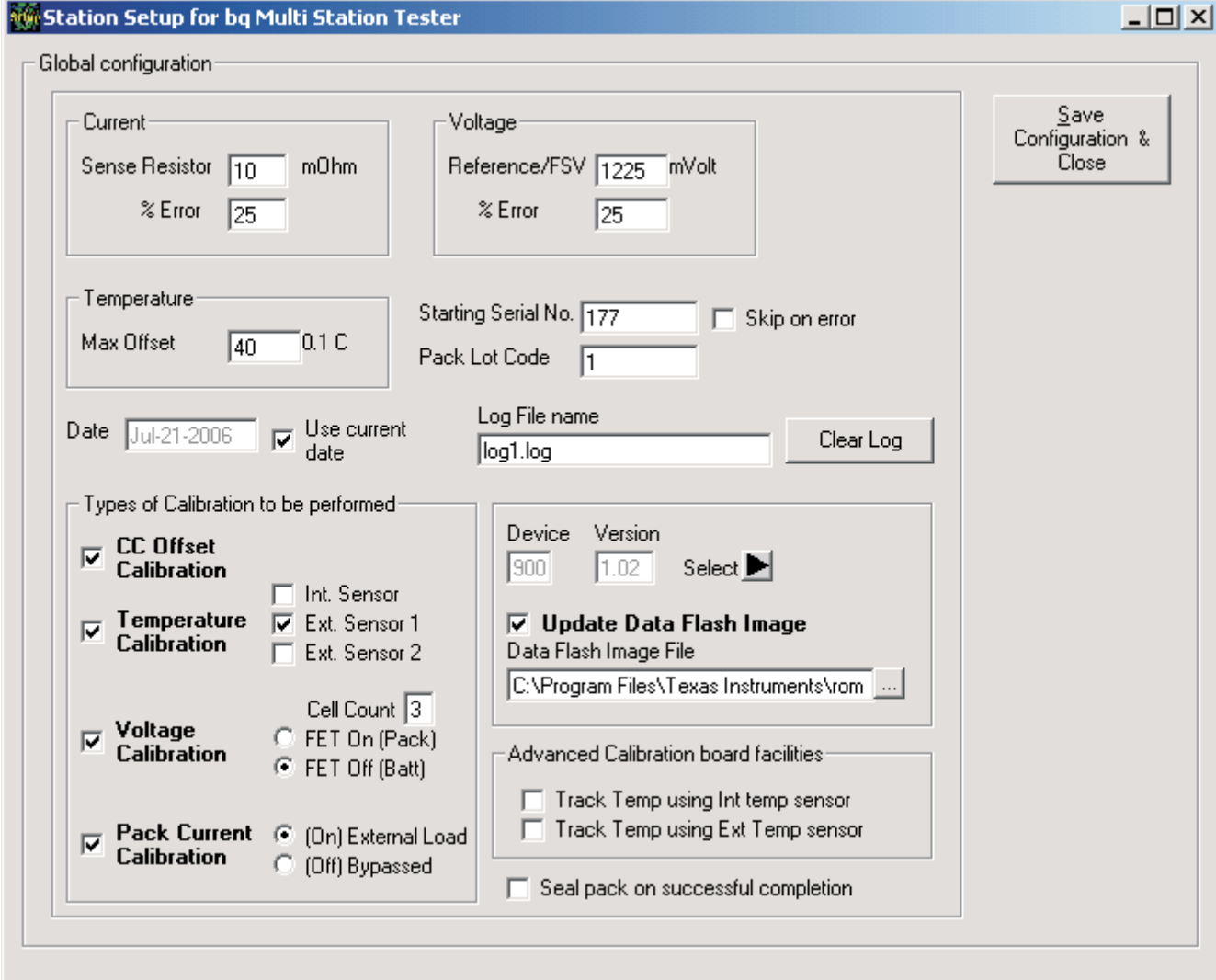

Station Setup for bq Multi Station Tester

Global configuration

Current
 Sense Resistor: 10 mOhm
 % Error: 25

Voltage
 Reference/FSV: 1225 mVolt
 % Error: 25

Temperature
 Max Offset: 40 0.1 C

Starting Serial No.: 177 Skip on error
 Pack Lot Code: 1

Date: Jul-21-2006 Use current date
 Log File name: log1.log

Types of Calibration to be performed

CC Offset Calibration
 Int. Sensor

Temperature Calibration
 Ext. Sensor 1
 Ext. Sensor 2

Voltage Calibration
 Cell Count: 3
 FET On (Pack)
 FET Off (Batt)

Pack Current Calibration
 (On) External Load
 (Off) Bypassed

Device: 900 Version: 1.02

Update Data Flash Image
 Data Flash Image File: C:\Program Files\Texas Instruments\rom ...

Advanced Calibration board facilities

Track Temp using Int temp sensor
 Track Temp using Ext Temp sensor
 Seal pack on successful completion

Figure 10. Global Configuration Screen

6.2.1 CC Offset Calibration

This is the coulomb counter offset. There are no user definable values in this box. This calibration can be selected by placing a check in its selection box or deselected by removing the check. The default is checked. Note: if this test is disabled, the values from the *gold* data flash file will be used and not the values currently in the part.

6.2.2 Voltage Calibration

Voltage calibration can be selected by placing a check in its selection box or deselected by removing the check. The default is checked. The voltage calibration area also has a box for the user to enter the number of series cells being simulated. The default number of cells is 4. It also has a FET Control selection area. *Off (Batt)* should be selected. *On (Pack)* should never be selected and is included only for possible future use. Note: if this test is disabled, the values from the *gold* data flash file will be used and not the values currently in the part.

6.2.3 Temperature Calibration

Temperature calibration can be selected by placing a check in its selection box or deselected by removing the check. The default is checked. The temperature calibration area also offers three different temperature probe selections. The proper selections should be made depending on the application. Note: if this test is disabled, the values from the *gold* data flash file will be used and not the values currently in the part.

6.2.4 Pack Current Calibration

Pack current calibration can be selected by placing a check in its selection box or deselected by removing the check. The default is checked. The pack current calibration area also allows FET control selection. *On (External Load)* should always be selected (this configuration is the default). *Off (Bypassed)* should never be selected and is only included for possible future use. Note: if this test is disabled, the values from the *gold* data flash file will be used and not the values currently in the part.

6.2.5 Current Frame

This frame contains two values:

1. **Sense Resistor:** Enter the value of the sense resistor used in the bq20zXX based smart battery pack in the *Sense Resistor* field. This value is entered in units of milliohms
2. **% Error:** Enter the desired acceptable percent error that the sense resistor can differ from the value listed in the *Sense Resistor* field in the *% Error* field. Note: the default value for this field is 25%. The value of 25% may seem like a large number but this value is not related to the calibration accuracy that the bqMTester calibrates to. That calibration is highly accurate. This *% Error* field is used as a rough test to make sure the sense resistor is mounted correctly and not shorted. After the bqMtester calibrates the Sense Resistor gain value then it compares the new calibration value to what is in the *Sense Resistor* field. If the percent difference between the 2 values is more than 25% then it fails the calibration because it assumes something must be grossly wrong to get a value more than 25% from the nominal *Sense Resistor Value* This value must be specified as a positive integer value.

6.2.6 Voltage Frame

This frame contains two values:

1. **Reference/FSV:** The tester calibrates the voltage gain by manipulating the Full Scale Voltage Reference. Do not change the values in this field.
2. **% Error:** The *% Error* field is used as a rough test to check the Voltage Measurement Circuitry. After the bqMtester calibrates the bq20zXX voltage gain then it compares the new calibration value to what is in the *Reference/FSV* field. If the percent difference between the 2 values is more than 25% then it fails the calibration because it assumes something must be grossly wrong to get a value more than 25% from the nominal.

6.2.7 Temperature Frame

This frame contains one value. Enter the maximum absolute value of offset that the bqMTester Software will be allowed to put into any of the data flash temperature offset registers for the module being tested. This is not an accuracy verify. This is a gross Error detection. The default value of this field is 40 meaning that the calibrated offset put in the data flash cannot exceed positive or negative 4°C. For internal Temperature Sensor calibration it is recommended to increase this value because internal temperature sensor offset accuracy commonly will exceed 4°.

6.2.8 Starting Serial Number

Enter the value for the serial number of the first bq20zXX based smart battery module to be tested. This number will be incremented by one as each new module is tested. If the *Skip On Error* check box is checked, the number will not be incremented in the case of a module that fails the test. The default for this box is 1. This value must be specified as a positive integer value.

6.2.9 Date

Enter the value for the desired date to be programmed into the bq20zXX based smart battery module. If the *Use Current Date* check box is checked, the system date from the PC running the bqMTester software will be used

6.2.10 Log File Name

Enter the complete path and file name to be used for the log file. This file will contain all relevant test data for each bq20zXX based smart battery module tested. If the *Clear Log* button is pressed, the log file contents will be deleted.

6.2.11 Pack Lot Code

Enter the value for the Lot Code of the group of bq20zXX based smart battery modules currently being tested. This number will not change until it is changed manually and will be programmed into each bq20zXX based smart battery module tested. This value must be specified as a positive integer value.

6.2.12 Save

Clicking the *Save Configuration and Proceed* button will cause the current configuration settings to be saved.

6.2.13 Data Flash Image File

Input the location of the data flash Golden file that will be stored in all parts that will be tested when running the bqMTester.exe program. Clicking the browse () button will give the option to browse for the Golden image file. If the *Update Data Flash Image* checkbox is not checked then no data flash image will be installed in any parts. It is always recommended that an Image file be used.

6.2.14 Device and Version

The correct Device and Version must be selected using the select () button. Once the select button is pressed, select the proper device and firmware version of the modules to be tested from the dialog box that appears. If the device or version desired is not available, check the Texas Instruments web site for an updated version of the bqMTester software in the bqMtester Tool Folder on the www.ti.com web site. The Tool Folder is located at:

<http://focus.ti.com/docs/toolsw/folders/print/bqmtester.html>

Advanced Information: For special/custom parts, it is possible that the part can be added to the file that holds all allowed parts compatible with bqMTester. Using this option is sometimes tricky. It is recommended that TI be contacted before using this option to ensure that the bqMTester has been tested with the requested device. The file to be edited is called *Targets* and is located in the directory that bqMTester was installed.

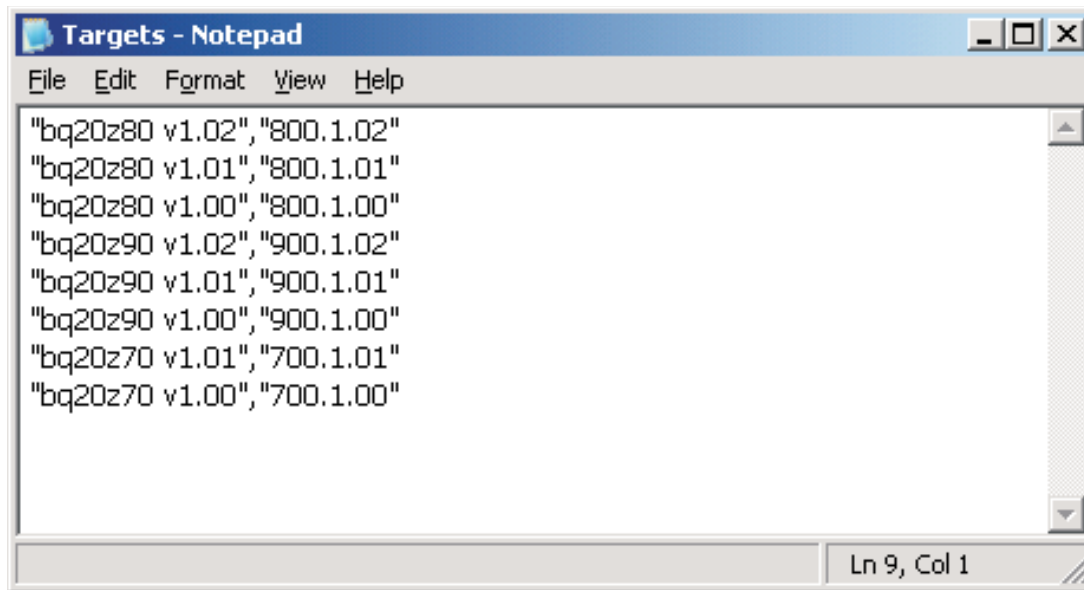

Figure 11. Example Targets File

NOTE: When using this option, very carefully verify that some modules are tested and calibrated with bqMTester software for accuracy and DF compatibility. This software is not designed for production. It is the responsibility of the user to make sure that bqMTester is compatible with the custom device.

6.2.15 Advanced Calibration Board Facilities

There are 2 checkboxes in this frame. Both should remain unchecked when using the Multi-site tester software. If these checkboxes are selected then they will override all selections made in the Temperature Probe Selection window. With either of these selected, every station will use its own Temperature Probe depending on whether Internal or External is selected.

6.2.16 Seal Pack on Successful Completion

If checked then the pack will be sealed upon completion of the test.

7 MultiStation Testing

7.1 Preparing the Test Software

To start testing modules, run the MultiStationTester.exe file. This will bring up the main Multi-Station Tester window. This window keeps track of all tests being done at each station, then logs and displays the information from the stations that were initialized and setup in section 3 of this document.

When the software opens, the *Start* button will be disabled by default until the voltage, current and temperature of all the references are verified by clicking on the *Configure VTI* button. The purpose of this is to secure the configuration via engineering approval prior to testing modules and as a reminder to ensure that the reference data is accurate before allowing testing.

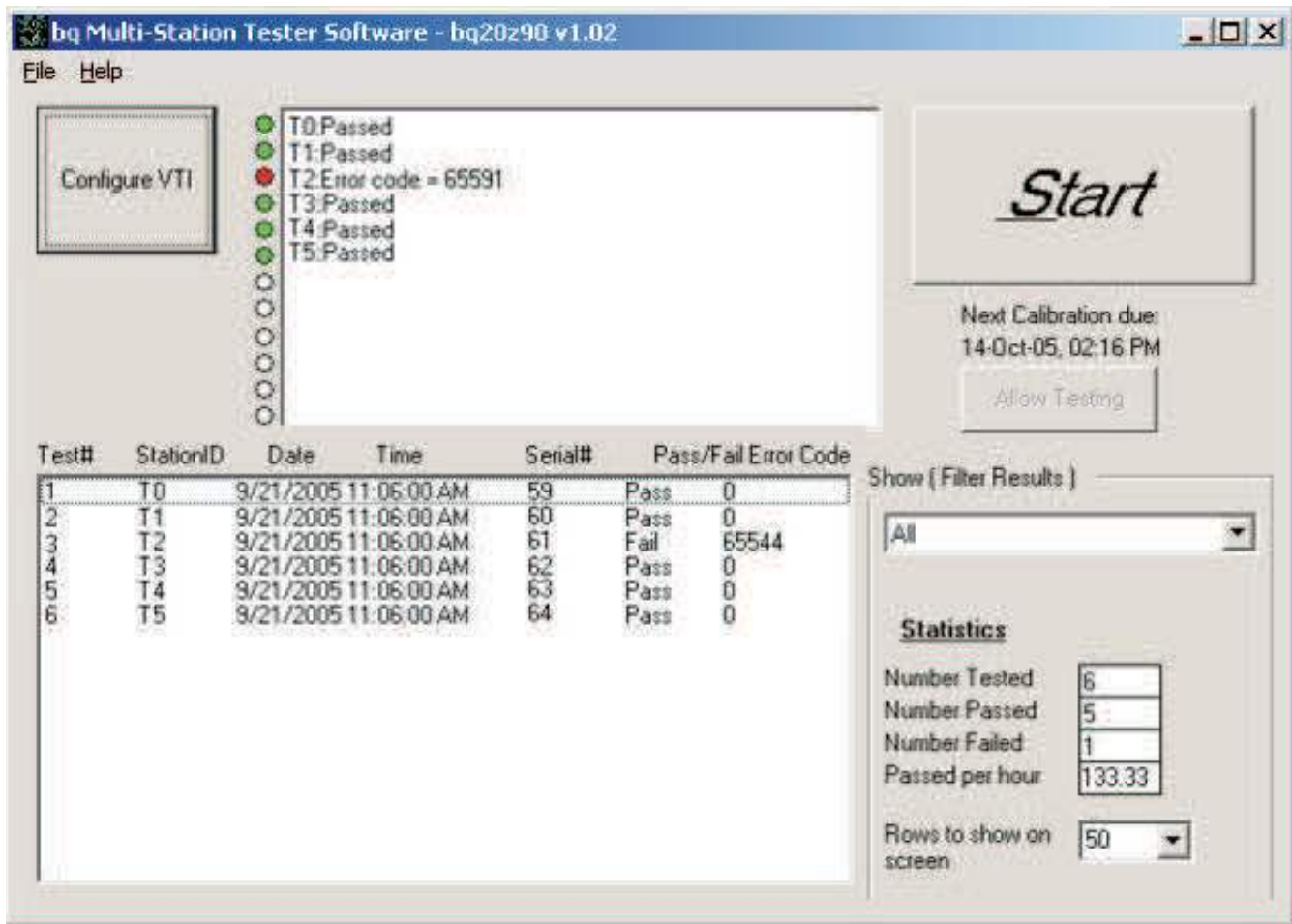

Figure 12. MultiStation Tester Window

7.1.1 Verifying V, T, I Configuration

First, click on the *Configure VT*, Button. The *Update VTI* window will pop up as shown in [Figure 13](#). If *Allow V, T, I while locked* is not selected then the *Unlock Configuration* button must be pressed to allow voltage, temperature, and current reference adjustment.

7.1.2 Reference Adjustments

Once unlocked, the references can be adjusted as required. When any field is clicked on in a particular station row then the LEDs for that station will start flashing, and the voltage and current power sources will power up. Clicking the **Read Currently Calibrated Temperatures** button will display the temperatures read from temperature probes associated with each station.

To calibrate the references, use the following process.

1. Measure the voltage for the first station by connecting a traceable DMM to the *Reference V Meter +* and *Reference V Meter -* connections as shown in [Figure 6](#) (shown as DMM1 in [Figure 6](#)) to measure the actual voltage of the cell simulation voltage supplied by the calibration board for the first station. Input this voltage in the voltage column for the first station. Repeat this step for each remaining station.
2. Setup the DMM for current measuring and connect the DMM to *Reference I Meter +* and *Reference I Meter -* as shown in [Figure 6](#) (shown as DMM2 in [Figure 6](#)) for the first station being setup. Be sure and disconnect the wire that shorted these 2 connections so that current will flow through the meter. Input the current measured in the current column for this station. Repeat this step for each remaining station. Re-install the short from the *Reference I Meter +* to the *Reference I Meter -*.

- Place the traceable temperature probe next to the temperature probe being used on the calibration board at the first station with a temperature probe being used for testing. Click the *Read the Currently Calibrated Temperatures* button. Compare the temperature from the traceable temperature probe to the calibration board temperature displayed. If the temperatures are different then type in the temperature from the traceable temperature probe into the corresponding temperature field. Type over the value displayed when the *Update VTI* button was pressed. Repeat this step for each station that has a temperature probe.

7.1.3 "Allow V, T, I While Locked" Selection

If the software is unlocked then the *Allow V, T, I while locked* checkbox will be enabled. Otherwise it will be dimmed (disabled). If selected, the user will be able to adjust the actual values for voltage, temperature, and current references even though the configuration has been locked. If not selected, the user will be unable to alter these values without unlocking the configuration.

7.1.4 Locking and Unlocking the Configuration

Once all information is updated as required then click *Update V, T, and I and Close*. This will lock the software and enable the *Start* button.

To unlock the software at any time, click the *Configure VTI* button on the main screen and then click the *Unlock Configuration* button. A password dialog window will be displayed. Supply the required password and click *OK*. The default password is *bq20z80*. This password should be changed after first use.

To change the password, click the *Lock Configuration* button. This will cause a password dialog window to appear. Enter a password and be sure to record it in a safe location for future reference. Re-enter the password to ensure it was not misspelled. Click on *OK*.

The software will always lock when the *Update VTI and Close* button is clicked. When either the *Update VTI and Close* button or the *Lock Configuration* buttons are pressed, notice that the *Lock Status* icon changes from an open lock to a closed lock.

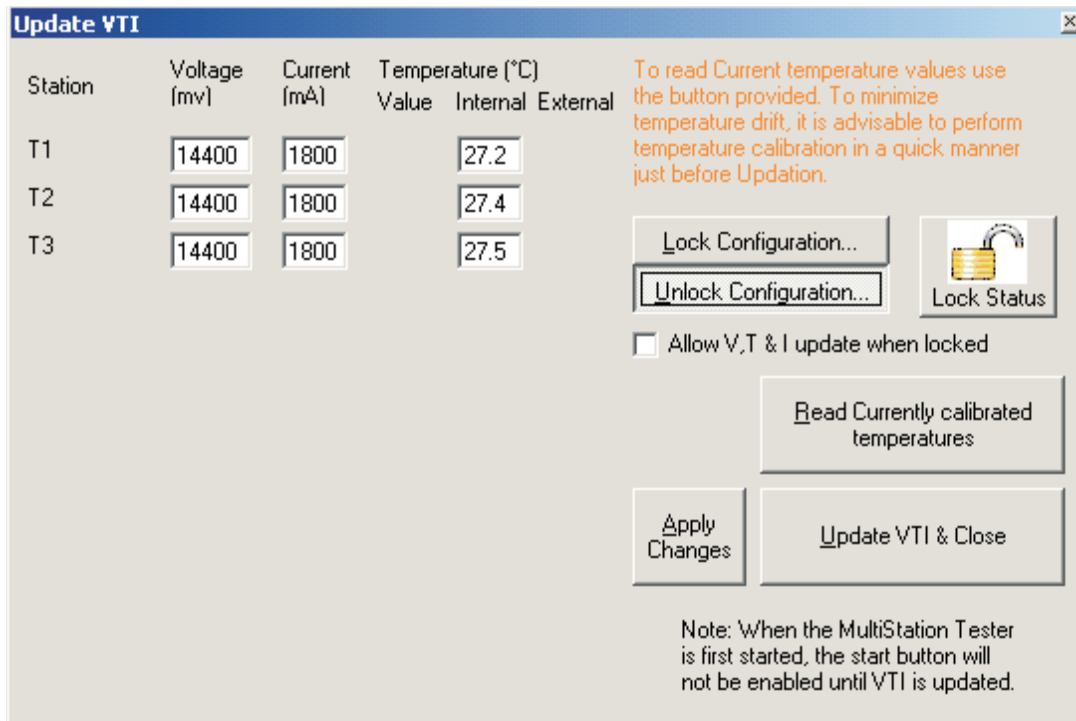

Figure 13. Update VTI Window

7.2 Testing Modules

Once setup is completed testing can begin. There are multiple indicators on the main screen of the Multi-site tester program and the *Start* button

7.2.1 Progress Text Box

The software displays a description of the progress of the test for each station in the text box in the upper center of the main window (see [Figure 12](#)). Only stations enabled will be displayed in this window. Next to the Progress Text Box is a column of simulated LEDs adjacent to each station progress entry. After a test finishes, this simulated LED will turn red or green depending on a pass or fail.

The progress steps are:

1. **Verifying Device Version:** Powering up device, waiting for parameters to settle, and verifying the version of firmware to be tested.
2. **Writing Data Image:** Writing the *Golden* image file to the Data Flash of the device under test.
3. **Calibrating:** Calibrating voltage, temperature, and current.
4. **Verifying Calibration Limits:** Verify that the calibrated gain and offset values did not go out of the ranges selected in the Tester Setup program.
5. **Pass or Error Code = XXXXX:** If the test failed then an error code is reported. The error code displayed with a failed part in the Progress Text Box will be a more detailed code than the error code reported in the Statistics Log text box.

7.2.2 Statistics Log Text Box

The Statistics Log Text box is located under the Progress Text Box. It shows the entire past statistical test data from all stations installed and selected. This data is also logged in a log file with the name entered in the Log File Name field on the Global Configuration screen of the Station Setup program. When more tests are performed than can fit in the Statistics Text Box then a scroll bar will appear on the right side of the box and only the most recent tests will be displayed. Past data can be seen by adjusting the scroll bar. Error codes reported here are of a more generic nature than the ones reported in the **Progress Test Box** as described above. Both error codes will be logged if a log file is open

7.2.3 Test#

Test# is the number of tests since the software was opened.

7.2.4 StationID

StationID is the name given to the station when the Station Setup software was run.

7.2.5 Date/Time

Date and Time is the date and time the tests were performed.

7.2.6 Serial#

Serial Number is the serial number given to the part. The serial number increments depending on the progress of the tests for each station. No two stations can have the same serial number even if they start at the same time because the software assigns serial numbers in such a way to prevent this. If Skip on Error is selected in the Station Setup software, a failed part will not be assigned a new serial number to help preserve serial numbers for parts that pass.

7.2.7 Pass/Fail Error Code

This is a more generic error code than the one in the Progress Text Box. The error code given here will tell what test failed. The 2 error codes can be used together to give a better understanding of what caused the error. If the test passed then this will be 0.

7.2.8 Filter Results Pull-Down Menu

This menu gives the option to filter the data shown in the Statistics Log Text Box to only show data for a specific station or for all stations at one time. It will list the stations by their Station ID.

7.2.9 Next Calibration Due

The *Next Calibration Due* Indicator indicates when the Multi-Station software will require a calibration of the Voltage, Current, and Temperature references due to timeout of an adjustable software timer in the global.ini file as shown in Figure 14. There are 3 adjustable values of interest in this file under the [CalRemind] Header:

1. REM_Timed_CallInterval: This is the period in minutes between forced calibrations.
2. REM_SnoozeInterval: This is the approximate time between reminders.
3. REM_SnoozeCount: This is the number of reminders that will occur prior to forced calibration.

Default settings are shown in Figure 14. With these settings the interval time will be 70 minutes. There will be 2 reminders prior to the 70 minute expiration. Each of these reminders will be 5 minutes apart so one will be at 60 minutes and the next would be at 65. Then at 70 minutes the *Start* button will be disabled until *VTI* Calibration Verification is performed. Adjustments can be made to this file to modify these settings. Caution should be taken when modifying the global.ini file. Only change the numbers beside the values. Any other changes could cause unpredictable results.

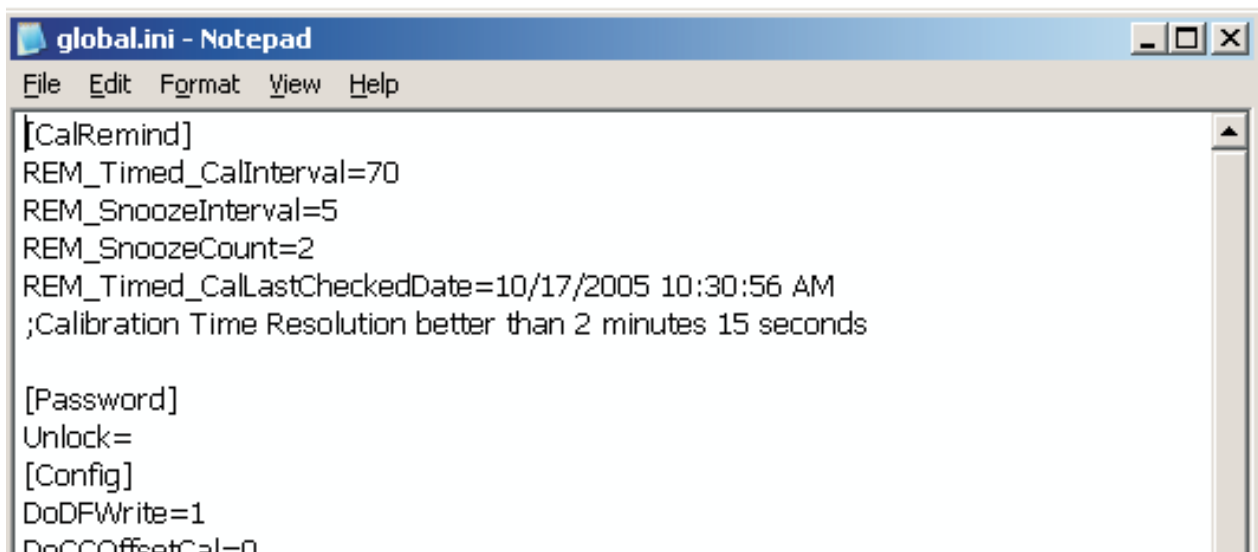

Figure 14. Global.ini file

7.2.10 "Allow Testing" Button

The *Allow Testing* button is pressed by the user to continue testing if a forced calibration reminder expires as described in *Next Calibration Due* above.

7.2.11 Real Time "Statistics"

The Statistics data displayed on the lower right corner of the main window displays real time test statistics for all stations combined.

7.2.12 Number Tested

This text box displays the total number of devices that have been tested on all test stations.

7.2.13 Number Passed

This text box displays the total number of devices that have passed the test on all test stations.

7.2.14 Number Failed

This text box displays the total number of devices that have failed the test on all test stations.

7.2.15 Passed per Hour

This text box displays the number of devices that have passed the test on average per hour.

7.2.16 Rows to Show on Screen

The system only remembers the statistical data from the number of tests that are selected in the *Rows to show on screen* pull-down menu.

7.2.17 "Start" Button

The start button is disabled every time the Multi-Station software is executed. VTI configuration must be verified to enable the *Start* button. Once this button is enabled, clicking it initiates testing at each of the installed stations that were setup and initialized with the Station Setup software. Each station performs its test independently of the others. The software tracks the test progress from each station.

Theory of Operation for HPA169 Calibration Board

The HPA169 multi-site tester board consists of three sections, a communication, control, and temperature section, a voltage supply section, and a current supply section. The board has been designed to be temperature independent. The board can be controlled through SMBUS via an EV2300 interface, or through a user designed custom interface supporting I2C. The board schematic shown below has been divided to show the three sections.

The communication, control, and temperature section consists of two ICs, a TMP100NA Digital Temperature Sensor with I2C interface, and a TPIC2810D 8-bit LED Driver with I2C interface. The TMP100NA is used to report the board temperature through SMBUS or I2C. The TPIC2810D is used not only to control board status LEDs, but also to enable and disable the voltage and current sections by controlling two optoisolators. Power for these two devices (5 VDC) is supplied from the EV2300 or custom user interface from the computers USB port. Headers have been provided on the board for the addition of an external I2C temperature sensor, an additional I2C communication port, and external status LEDs.

The voltage supply section consists of a TL317 100mA Adjustable Positive Voltage Regulator set to supply 20 VDC, a REF02 +5V Precision Voltage Reference, a H11A817B optoisolator, a 2N7002 N-channel FET, a OPA2244 dual op amp, a MMBT3904LT1 general purpose NPN transistor, and various capacitors, and resistors. Power is supplied to the voltage supply section with a 24V, 500mA wall mounted power supply. When power is supplied to the voltage supply section, the *Voltage Supply* LED will light, the TL317 will supply 20 V, and the REF02 will supply a 5 V reference. The REF02 is a high precision reference with very low temperature drift. The voltage divider formed by R11 and R18 will cause 3.3 V to appear on the positive input of the OPA2244 error amp. R11 and R18 are high precision 0.5% 25 PPM resistors. These values are critical to ensure 3.3 V is supplied to the positive input of the error amp. Resistors R6, R10, and R13 are selectable with jumpers J4, J5, and J6, and control the gain of the error amp so that its output is 14.4 V, 10.8 V, 7.2 V, or 3.6 V depending on the number of series cells being simulated. The MMBT3904LT1 FET provides current boost. R30, R31, R32, and R33 are the jumper selectable cell simulation resistors. Jumpers J7 and J8 are used to select 2, 3, or 4 series cells. The voltage selected by jumpers J4, J5, and J6 will be divided over the cell simulation resistors. Appropriate jumpers should be selected so that the supplied voltage divided by the number of cells simulated is equal to 3.6V. The H11A817B optoisolator and 2N7002 FET are used to enable or disable the voltage supply. An enable or disable command is sent via SMBUS from the EV2300 or user supplied I2C controller to the TPIC2810D LED driver which then enables or disables the appropriate output pin which is connected to the H11A817B optoisolator. This causes the optoisolator to turn on or turn off the 2N7002 FET which in turn will ground or unground the positive input of the OPA2244 error amp. Grounding the input will cause the output of the error amp to go to 0 V, which will disable the voltage supply. The transition of the TPIC2810D output pin will also cause the *Voltage On* LED to light or go out.

The current supply section consists of a REF3130 +3V Precision Voltage Reference, a H11A817B optoisolator, a 2N7002 N-channel FET, a OPA2335 dual op amp, a IRF3709 FET, a 20 milliohm sense resistor, 4 1 ohm 2W resistors, and various capacitors and resistors. Power is supplied to the current supply section with a 5V, 3A wall mounted power supply. When power is supplied to the current supply section, the *Current Supply* LED will light. Current flows from the power supply, through the IRF3709 FET, through the 20 milliohm sense resistor, through the 1 ohm 2 W heat dissipating resistors, through a user supplied reference meter, through the sense resistor in the unit under test, and back to the wall mounted power supply. This current will induce a voltage across the 20 milliohm sense resistor which is then amplified by the differential amplifier (U7:B). The voltage from the differential amplifier is then fed back into the error amp (U7:A). The error amp gets its reference voltage from the REF3133 +3.3V voltage reference. The REF 3133 is a high precision reference with very low temperature drift. The output of the error amp drives the gate of the IRF3709 FET. This feedback arrangement ensures that the current in the current loop remains exactly 2 A regardless of the temperature. The H11A817B optoisolator and 2N7002

FET are used to enable or disable the current supply. An enable or disable command is sent via SMBUS from the EV2300 or user supplied I2C controller to the TPIC2810D LED driver which then enables or disables the appropriate output pin which is connected to the H11A817B optoisolator. This causes the optoisolator to turn on or turn off the 2N7002 FET which in turn will ground or unground the gate of the IRF3709 FET. Grounding the gate will turn off the FET and disable the current supply. The transition of the TPIC2810D output pin will also cause the *Current On* LED to light or go out.

HPA169 Schematic

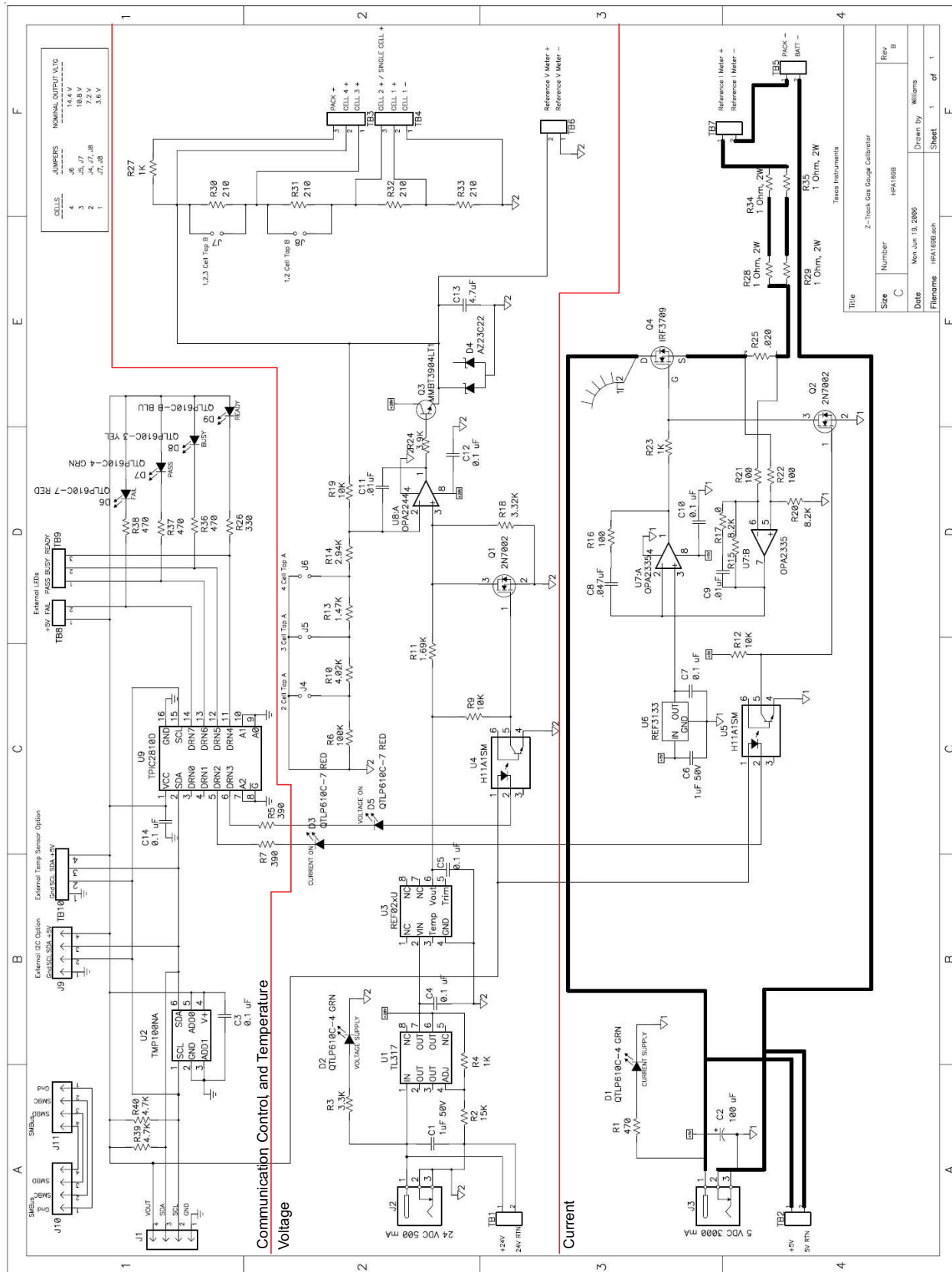

HPA169 Cal Board Bill of Materials

Table 1. HPA169A Bill of Materials

COUNT	REF DES	VALUE	DESCRIPTION	SIZE	PART NUMBER	MFR
2	C1, C6	1uF 50V	Capacitor, Ceramic, 1.0uF, 50-V, X7R, 15%	1206	STD	Any
1	C13	4.7uF	Capacitor, Ceramic, 4.7 uF, 25 V, X7R, 10%	1206	STD	Any
1	C2	100 uF	Capacitor, Aluminum, 100-uF, 10-V, 20%	0.177 x 0.177	ECE-V1AA1010WR	Panasonic
7	C3, C4, C5, C7, C10, C12, C14	0.1 uF	Capacitor, Ceramic, 0.1-uF, 50-V, X7R, 10%	0603	STD	Any
1	C8	0.047uF	Capacitor, Ceramic, 0.047 uF, 50 V, X7R, 10%	0603	STD	Any
2	C9, C11	.01uF	Capacitor, Ceramic, 0.01-uF, 25-V, X7R, 15%	0603	STD	Any
3	D1, D2, D7	QTLP610C-4 GRN	Diode, LED green, 30-mA, xx-mcd	0.126 x 0.087 inch	QTLP610C-4	Fairchild
3	D3, D5, D6	QTLP610C-7 RED	Diode, LED Red, 30-mA, 25-mcd	0.126 x 0.087 inch	QTLP610C-7	Fairchild
1	D4	AZ23C22	Diode, Dual, Zener, 22V, 300mW	SOT23	AZ23C22	Vishay-Telefunken
1	D8	QTLP610C-3 YEL	Diode, LED yellow, 30-mA, xx-mcd	0.126 x 0.087 inch	QTLP610C-3	Fairchild
1	D9	QTLP610C-B BLU	Diode, LED blue, 30-mA, xx-mcd	0.126 x 0.087 inch	QTLP610C-B	Fairchild
1	HS1	6298B	Heatsink, TO-220, Vertical-mount, 3.9°C/W	1.67 x 1.00	6298B	Thermalloy
4	J1, J9, J10, J11	22-05-3041	Header, Friction Lock Ass'y, 4-pin Right Angle	0.400 x 0.500	22-05-3041	Molex
1	J2	24 VDC 500 mA	Connector, 2,1mm, DC Jack w/Switch, TH	0.57 x 0.35	RAPC 722	Switchcraft
1	J3	5 VDC 3000 mA	Connector, 2,1mm, DC Jack w/Switch, TH	0.57 x 0.35	RAPC 722	Switchcraft
5	J4, J5, J6, J7, J8		Header, 2-pin, 100mil spacing, (36-pin strip)	0.100 x 2"	PTC36SAAN	Sullins
2	Q1, Q2	2N7002	MOSFET, N-ch, 60-V, 115-mA, 1.2-Ohms	SOT23	2N7002DICT	Vishay-Liteon
1	Q3	MMBT3904LT1	Bipolar, NPN, xx-V, yy-mA, zz-W	SOT23	MMBT3904LT1	On Semi
1	Q4	IRF3709	MOSFET, N-ch, 30V, 90A, 9 milliohm	TO-220AB	IRF3709	IR
4	R1, R36, R37, R38	470	Resistor, Chip, 470-Ohms, 1/16-W, 5%	0603	Std	Std
1	R10	4.02K	Resistor, Chip, 4.02K-Ohms, 1/10-W, 0.5%, 25PPM	0805	Panasonic ERA-6YHD	Panasonic
1	R11	1.69K	Resistor, Chip, 1.69K-Ohms, 1/10-W, 0.5%, 25PPM	0805	Panasonic ERA-6YHD	Panasonic
1	R13	1.47K	Resistor, Chip, 1.47K-Ohms, 1/10-W, 0.5%, 25PPM	0805	Panasonic ERA-6YHD	Panasonic
1	R14	2.94K	Resistor, Chip, 2.94K-Ohms, 1/10-W, 0.5%, 25PPM	0805	Panasonic ERA-6YHD	Panasonic
2	R15, R20	8.2K	Resistor, Chip, 8.2K-Ohms, 1/16-W, 0.1%, 25ppm	0603	Panasonic ERA-3YEB	Panasonic
1	R16	100	Resistor, Chip, 100-Ohms, 1/16-W, 5%	0603	Std	Std
1	R17	0	Resistor, Chip, 0-Ohms, 1/16-W, 5%	0603	Std	Std
1	R18	3.32K	Resistor, Chip, 3.32K-Ohms, 1/10-W, 0.5%, 25PPM	0805	Panasonic ERA-6YHD	Panasonic
1	R19	10K	Resistor, Chip, 10K-Ohms, 1/10-W, 0.5%, 25PPM	0805	Panasonic ERA-6YHD	Panasonic
1	R2	15K	Resistor, Chip, 15K-Ohms, 1/16-W, 5%	0603	Std	Std
2	R21, R22	100	Resistor, Chip, 100-Ohms, 1/16-W, 0.1%, 25ppm	0603	Panasonic ERA-3YEB	Panasonic
1	R24	3.9K	Resistor, Chip, 3.9K-Ohms, 1/16-W, 5%	0603	Std	Std
1	R25	0.02	Resistor, Chip, 0.02-Ohms, 1-W, 1%, 50ppm	2512	WSL-2512-010 1% R86	Vishay
1	R26	330	Resistor, Chip, 330-Ohms, 1/16-W, 5%	0603	Std	Std
4	R28, R29, R34, R35	1 Ohm, 2W	Resistor, Metal Strip, 1-Ohms, 2-W, 5%	4527	WSR21R000JEK	Vishay Dale
1	R3	3.3K	Resistor, Chip, 3.3K-Ohms, 1/16-W, 5%	0603	Std	Std
4	R30, R31, R32, R33	210	Resistor, Chip, 210-Ohms, 1/4-W, 0.1%, 25-PPM	1210	Panasonic ERA-14EB	Panasonic

Table 1. HPA169A Bill of Materials (continued)

COUNT	REF DES	VALUE	DESCRIPTION	SIZE	PART NUMBER	MFR
2	R39, R40	4.7K	Resistor, Chip, 4.7K-Ohms, 1/16-W, 5%	0603	Std	Std
3	R4, R23, R27	1K	Resistor, Chip, 1K-Ohms, 1/16-W, 5%	0603	Std	Std
2	R5, R7	390	Resistor, Chip, 390-Ohms, 1/16-W, 5%	0603	Std	Std
1	R6	100K	Resistor, Chip, 100K-Ohms, 1/10-W, 0.5%, 25PPM	0805	Panasonic ERA-6YHD	Panasonic
2	R9, R12	10K	Resistor, Chip, 10K-Ohms, 1/16-W, 5%	0603	Std	Std
6	TB1, TB2, TB5, TB6, TB7, TB8		Terminal Block, 2-pin, 6-A, 3.5mm	0.27 x 0.25	ED1514	OST
1	TB10	ED1516	Terminal Block, 4-pin, 6-A, 3.5mm	0.55 x 0.25	ED1516	OST
3	TB3, TB4, TB9		Terminal Block, 3-pin, 6-A, 3.5mm	0.41 x 0.25	ED1515	OST
1	U1	TL317	IC, 3-Terminal Adjustable Regulator	SO-8	TL317CD	TI
1	U2	TMP100NA	IC, Digital Temperature Sensor With I ² C Interface	SOT23-6	TMP100NA	TI
1	U3	REF02BU	IC, +5V Precision Voltage Reference	SO-8	REF02BU	TI
2	U4, U5	H11A817B	IC, OPTOISOLATOR, H11A817B	SOP-6	H11A817BS_NF098	Fairchild
1	U6	REF3133	IC, Voltage Reference, 15ppm/°C Max, 100uA	SOT23	REF3133AIDBZ	TI
1	U7	OPA2335	IC, Single Supply CMOS Op Amp, Dual, 0.05 V/ °C max,	MSOP-8	OPA2335AIDGK	TI
1	U8	OPA2244	IC Single Supply Dual Opamp	MSOP-8	Digikey OPA2244EACT-ND	TI
1	U9	TPIC2810D	IC, 8--Bit Led Drive With I ² C Interface	SO16	TPIC2810D	TI

HPA169 Board Layout

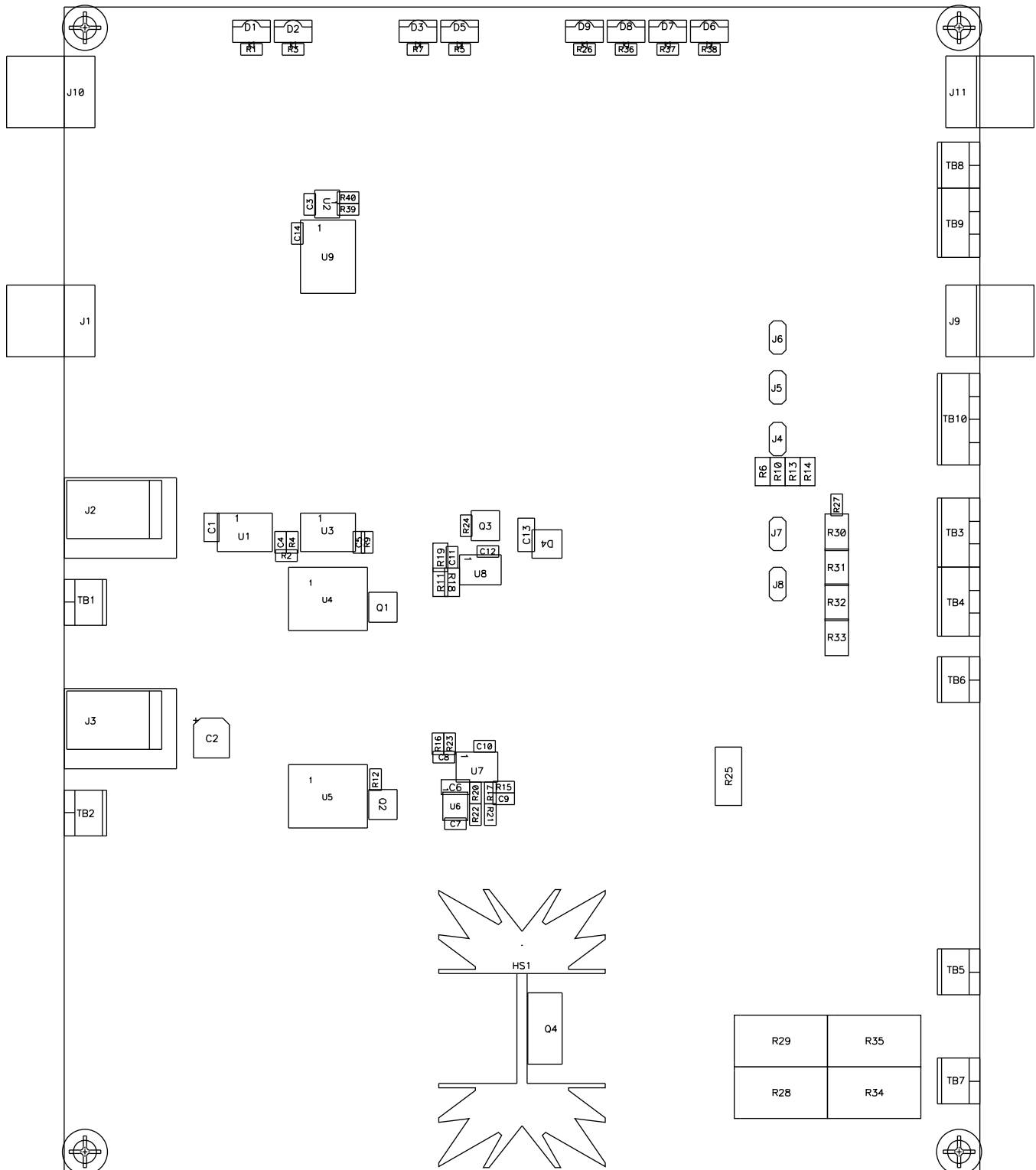

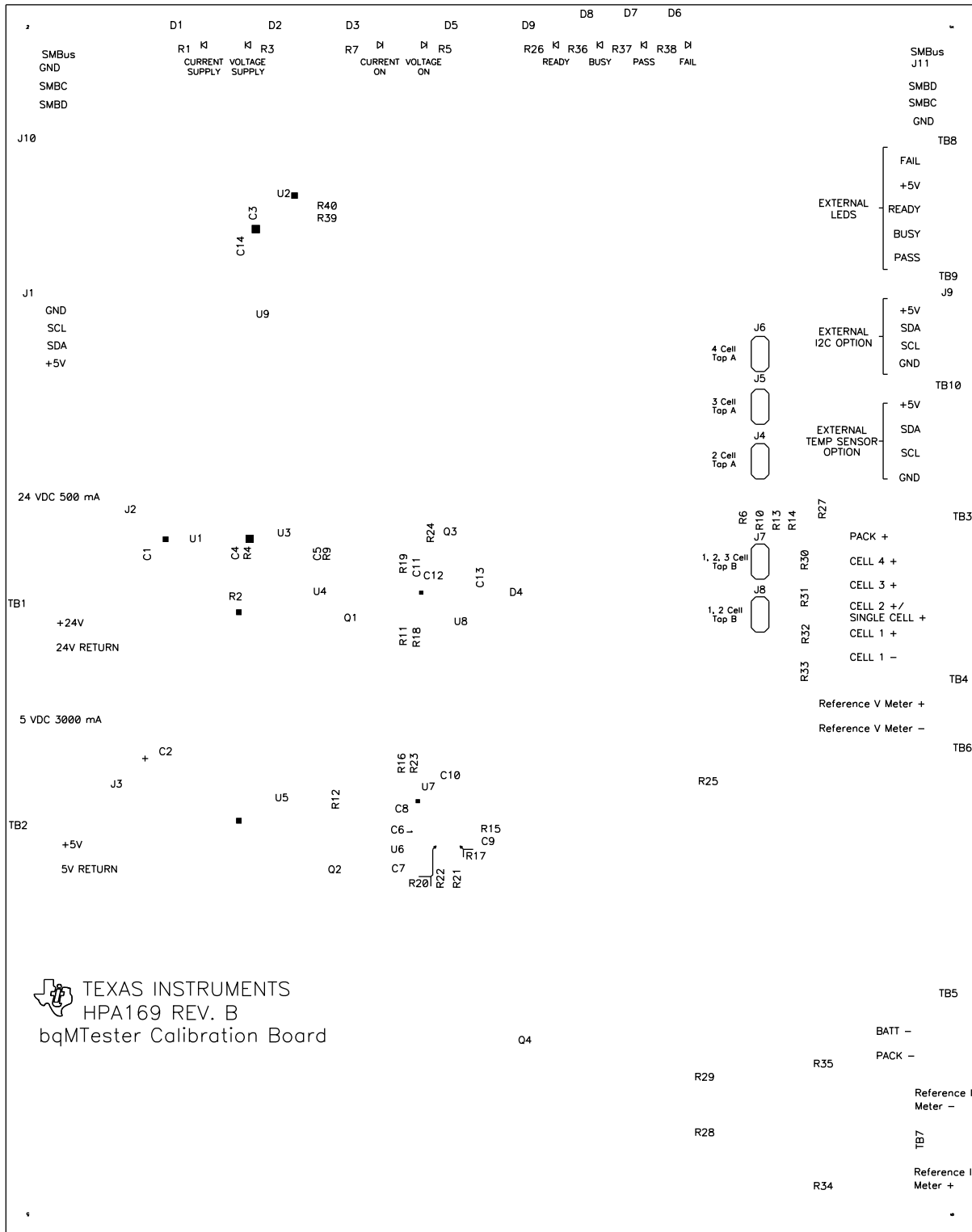

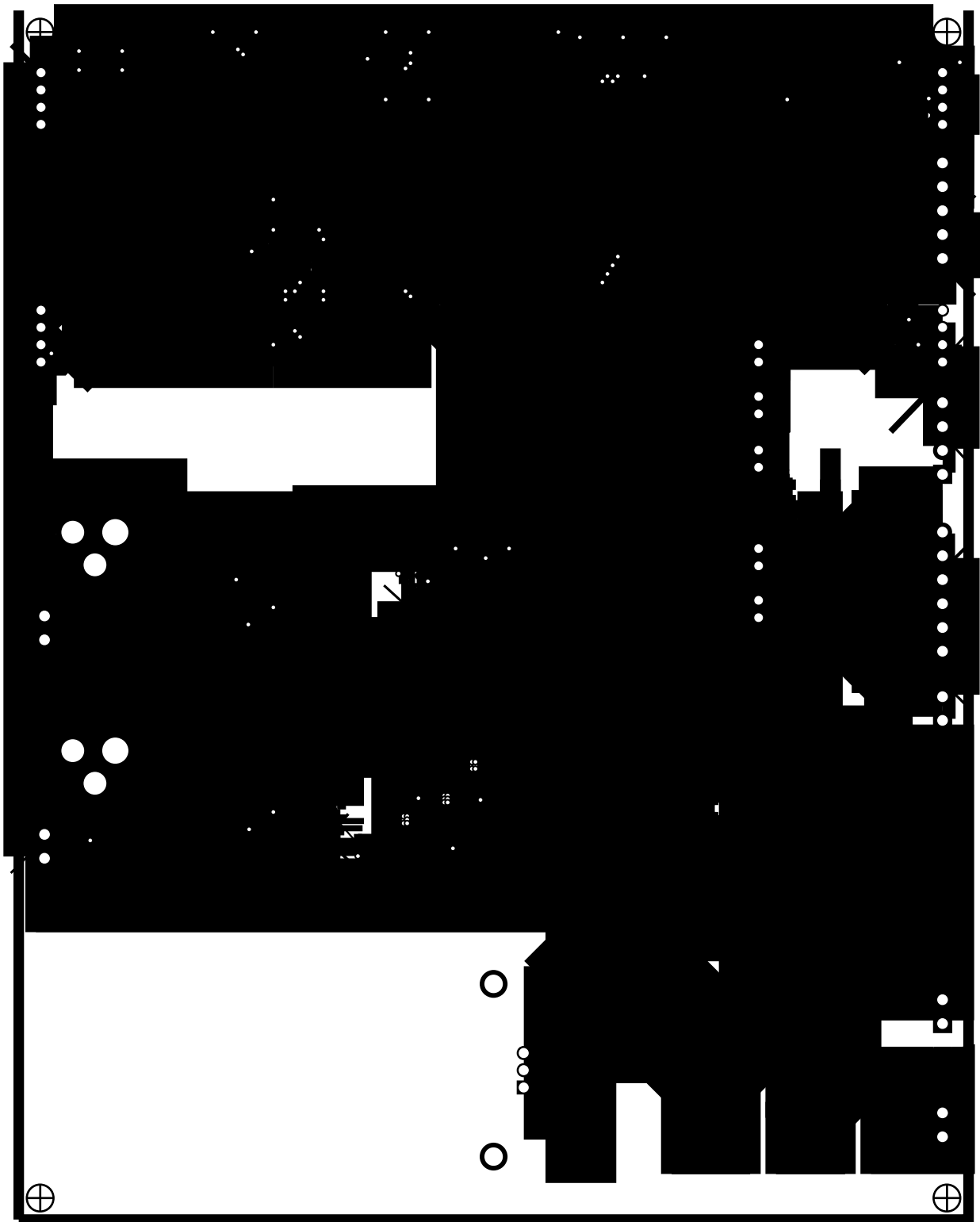

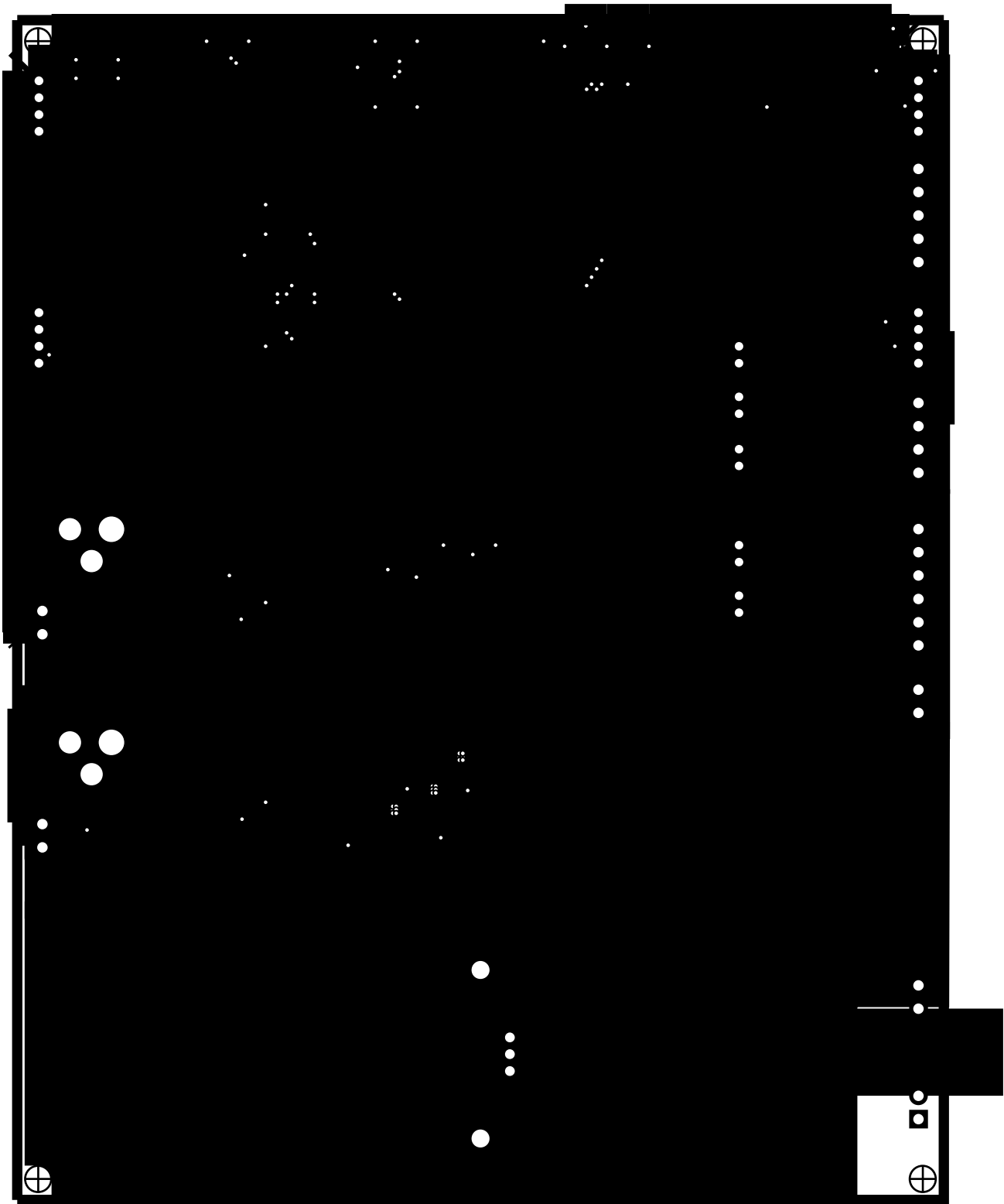

Error Code Definitions

Table 2. Error Code Definitions

Error Code	Error #	Description	Most Probable Cause	Possible Action
NO_ERROR	0	Successful (No errors)		
LOST_SYNC	1	EV2300 lost synchronization	EV2300 has outdated firmware or drivers are outdated.	Contact TI to get EV2300 with latest firmware. Ensure latest drivers for EV2300 installed.
NO_USB	2	USB Connection Missing	No EV2300 is connected.	Close program, reboot, and connect EV2300 first.
BAD_PEC	3	Bad PEC on SMBus	Possible Bad hardware.	Replace EV2300 / target board
WRONG_NUM_BYTES	5	Unexpected number of bytes sent/received	Unexpected hardware behavior.	May need assistance from TI
T2H_UNKNOWN	6	SMBus communication terminated unexpectedly / timed out or the bus was busy.	Wrong kind of target connected or target timing is off Trim oscillator	make sure that the target mode accepts the SMB command being sent
INCORRECT_PARAM	7	Invalid parameter type passed to function – especially Variant argument.	Incorrect parameter in call to function. Software Bug or overflow	Contact TI
TIMEOUT_ERROR	8	USB Timeout	No response on USB	EV2300 or driver problems or software is not supposed to wait for a response.
INVALID_DATA	9	AssemblePacket could not build a valid packet	Bad data / bad packet. Software found problem with data	Possible version incompatibility between BqTester and Module under test.
ERR_UN SOLICITED_PKT	10	Found an unsolicited non-error packet when looking for error packets	Unexpected packet received. The packet may be a response from a previous transaction that failed or that did not check the response.	Make corrections to software
COMPARE_DIFFERENT	11	Comparison failed and data read is different from srec	Flash comparison results in mismatch. Possible Flash failure or SMBus failure.	Module under test Flash failure
BQ80XRW_OCX_INTERNAL_ERROR	12	Problems with pointers being NULL etc.	Possible software bug or overflow.	Contact TI
USER_CANCELLED_OPERATION	34	User clicked on cancel button on progress bar dialog		
DF_CHECKSUM_MISMATCH	51	Data Flash checksum mismatch	Flash comparison results in mismatch. Possible Flash failure or SMBus failure.	Module under test Flash failure
IF_CHECKSUM_MISMATCH	52	Instruction Flash checksum mismatch	Flash comparison results in mismatch. Possible Flash failure or SMBus failure.	Module under test Flash failure
OPERATION_UNSUPPORTED	53	Unsupported type	Software problem	Check that Module under test and bqTester versions are compatible. Then contact TI
ERR_TOO_MANY_QUERIES	81	Not used		
ERR_BAD_QUERY_ID	82	Not used		
BAD_CRC	83	Packet was corrupted during USB communication	Too much noise or bad connection	

Table 2. Error Code Definitions (continued)

Error Code	Error #	Description	Most Probable Cause	Possible Action
ERR_TOO_MANY_RESPONSES	84	Not used		
ERR_NO_QUERIES_TO_DELETE	85	Not used		
ERR_QUERY_UNAVAILABLE	86	Not used		
ERR_NO_RESPONSES_TO_DELETE	87	Not used		
ERR_RESPONSE_UNAVAILABLE	88	Not used		
ERR_TMMT_NO_RESPONSE	90	Not used		
T2H_ERR_TIMEOUT	92	SMBus communication terminated unexpectedly / timed out or the bus was busy.	Wrong kind of target connected or target timing is off Trim oscillator	make sure that the target mode accepts the SMB command being sent
BUS_BUSY	94	SMBus communication terminated unexpectedly / timed out or the bus was busy.	Wrong kind of target connected or target timing is off Trim oscillator	make sure that the target mode accepts the SMB command being sent
T2H_ERR_BAD_SIZE	95	SMBus communication terminated unexpectedly / timed out or the bus was busy.	Wrong kind of target connected or target timing is off Trim oscillator	make sure that the target mode accepts the SMB command being sent
ERR_BAD_PAYLOAD_LEN	97	Packet was corrupted during USB communication or software sent in a bad packet	Bad USB connection	Check Version Compatibility and USB cable
ERR_TMMT_LIST_FULL	98	Not used		
ERR_TMMT_BAD_SELECTION	99	Not used		
UNKNOWN	100	Unexpected/unknown error		Outdated software Contact TI
UNEXPECTED_ERROR	110	Should not happen	Unexpected error	Hardware not expected to respond to this error
OUT_OF_MEMORY	111	Not enough memory on PC		Install more memory
SREC_OPEN_FAIL	221	Srec specified does not exist or cannot be opened	SREC targets a different device than the one detected on the SMBus	Ensure version compatibility between bqMtester software and Module under Test.
SREC_BAD_START_RECORD	222	Srec not in expected format	SREC targets a different device than the one detected on the SMBus	Ensure version compatibility between bqMtester software and Module under Test.
SREC_UNKNOWN_TYPE	223	Srec not in expected format	SREC targets a different device than the one detected on the SMBus	Ensure version compatibility between bqMtester software and Module under Test.
SREC_BAD_CHECKSUM	224	Srec not in expected format	SREC targets a different device than the one detected on the SMBus	Ensure version compatibility between bqMtester software and Module under Test.
SREC_BAD_RECORD_COUNT	225	Srec not in expected format	SREC targets a different device than the one detected on the SMBus	Ensure version compatibility between bqMtester software and Module under Test.
SREC_DEV_MISMATCH	226		SREC targets a different device than the one detected on the SMBus	Ensure version compatibility between bqMtester software and Module under Test.
CONFIG_OPEN_FAIL	227	Config file not found / cannot be opened		Redo StationSetup.exe configuration
CONFIG_UNEXPECTED_EOF	228	Config file not found / cannot be opened		Redo StationSetup.exe configuration
CONFIG_BAD_FORMAT	229	Config file format incorrect		Redo StationSetup.exe configuration
PCFG_DEVVER_MISMATCH	231	Config file device version not compatible		Ensure version compatibility between bqMtester software and Module under Test.

Table 2. Error Code Definitions (continued)

Error Code	Error #	Description	Most Probable Cause	Possible Action
PCFG_DEV_MISMATCH	232	Config file device not compatible		Ensure version compatibility between bqMtester software and Module under Test.
PCFG_SRECDEVVER_MISMATCH	233	Srec not compatible with current hardware device		Ensure version compatibility between bqMtester software and Module under Test.
PCFG_SRECDEV_MISMATCH	234	Srec not compatible with current hardware device		Ensure version compatibility between bqMtester software and Module under Test.
BCFG_DEVVER_MISMATCH	235	Srec not compatible with current hardware device		Ensure version compatibility between bqMtester software and Module under Test.
BCFG_DEV_MISMATCH	236	Srec not compatible with current hardware device		Ensure version compatibility between bqMtester software and Module under Test.
SMBC_LOCKED	260	Unused but reserved for backward compatibility		
	516	Unused but reserved for backward compatibility		
T2H_NACK	772	No response from target	Target not connected/not powered	Connect target and check is correct power is applied
SMBD_LOW	1028	Unused but reserved for backward compatibility		
SMB_LOCKED	1284	Unused but reserved for backward compatibility		
ERR_NOTHINGTODO	5001	Calling the function with specified values resulted in nothing being done		
ERR_VOLTAGE_LESSTHANZERO	5002	Specified Voltage must be greater than 0		
ERR_TEMPERATURE_LESSTHANZERO	5003	Specified temperature must be greater than 0		
ERR_CURRENT_EQUALSZERO	5004	Specified current cannot be 0		
ERR_NOT_IN_CAL_MODE	5010	Gas gauge was not in Calibration mode/ could not be put in calibration mode		
ERR_CALIBRATION_IN_FIRMWARE_FLASHWRITE	5020	Error writing flash in calibration mode		
ERR_CALIBRATION_IN_FIRMWARE_AFE	5021	Error in AFE calibration	Value too large (Overflow) in firmware	
ERR_CALIBRATION_IN_FIRMWARE_PACKV	5022	Error in Pack voltage calibration	Value too large (Overflow) in firmware	
ERR_CALIBRATION_IN_FIRMWARE_PACKG	5023	Error in Pack gain calibration	Value too large (Overflow) in firmware	
ERR_CALIBRATION_IN_FIRMWARE_VGAIN	5024	Error in Voltage gain calibration	Value too large (Overflow) in firmware	
ERR_CALIBRATION_IN_FIRMWARE_CCIGAIN	5025	Error in Current gain calibration	Value too large (Overflow) in firmware	
ERR_CALIBRATION_IN_FIRMWARE_TMPOFFEXT1	5026	Error in external temperature 1 offset calibration	Value too large (Overflow) in firmware	
ERR_CALIBRATION_IN_FIRMWARE_TMPOFFEXT2	5027	Error in external temperature 2 offset calibration	Value too large (Overflow) in firmware	
ERR_CALIBRATION_IN_FIRMWARE_TMPOFFINT	5028	Error in internal temperature offset calibration	Value too large (Overflow) in firmware	
ERR_CALIBRATION_IN_FIRMWARE_ADCOFF	5029	Error in ADC offset calibration	Value too large (Overflow) in firmware	

Table 2. Error Code Definitions (continued)

Error Code	Error #	Description	Most Probable Cause	Possible Action
ERR_CALIBRATION_IN_FIRMWARE_BRDOFF	5030	Error in Board offset calibration	Value too large (Overflow) in firmware	
ERR_CALIBRATION_IN_FIRMWARE_CCIOFF	5031	Error in CC offset calibration	Value too large (Overflow) in firmware	
ERR_CALIBRATION_IN_FIRMWARE_RSVD0	5032	Reserved for future use		
ERR_CALIBRATION_IN_FIRMWARE_RSVD1	5033	Reserved for future use		
ERR_CALIBRATION_IN_FIRMWARE_RSVD2	5034	Reserved for future use		
ERR_CALIBRATION_IN_FIRMWARE_RSVD3	5035	Reserved for future use		
ERR_CALIBRATION_IN_FIRMWARE_RSVD4	5036	Reserved for future use		
ERR_CALIBRATION_IN_FIRMWARE_RSVD5	5037	Reserved for future use		
ERR_CALIBRATION_IN_FIRMWARE_RSVD6	5038	Reserved for future use		
ERR_CALIBRATION_IN_FIRMWARE_UNDEFINED	5039	Unknown error code returned by hardware	Software is obsolete	
ERR_DF_RD_REQ_B4_WR	5041	Data flash cannot be written before reading the remaining values in a given class		
ERR_INVALID_DATA_ENTERED	5042	Invalid data entered on screen		
ERR_USB_ACQUIRE	5043	EV2300 is locked by another thread	Attempting to do multiple transactions possibly from different windows in background at the same time. Could also be a software problem. Stop scanning in SBS.	
NVALID_FILENAME	65537			Check File Name for Rom File and Log File
DEVICE_VERSION_MISMATCH	65538	Incompatible device/version		Check Connections. Verify version compatibility between bqMtester software and Module under Test.
RETURN_TO_ROM_FAILED	65539	Gas gauge could not be put in Rom mode	Hardware incompatibility	Check Connections. Verify version compatibility between bqMtester software and Module under Test.
RUNGG_FAILED	65541	Gas gauge could not exit ROM mode	Hardware incompatibility	Check Connections. Verify version compatibility between bqMtester software and Module under Test.
WRITEFLASH_GG_FAILED	65542	Writing to flash failed	Data Flash Failure	Module Repair
CALIBRATE_FAILED	65543	Calibration failed	Module hardware failure or Configuration failure	Module Repair or Check Testing Configuration Settings
POST_CAL_CHECKS_FAILED	65544	Post calibration checks failed	Module hardware failure or Configuration failure	Module Repair or Check Testing Configuration Settings
WRITESERIAL_FAILED	65545	Write serial number failed	Data Flash Failure	Module Repair/Retry Test
ERR_UNEXPECTED	65552	Unexpected value/response	Software does not know how to handle this	
ERR_FILE	65553	Error opening/processing File	Wrong File location settings.	Check all File location settings in bqMTester Software
ERR_NOT_IN_ROM	65554	GG not in ROM mode when expected – communication failure?	Gas gauge could not be put in ROM	Check Connections. Verify version compatibility between bqMtester software and Module under Test.

Table 2. Error Code Definitions (continued)

Error Code	Error #	Description	Most Probable Cause	Possible Action
ERR_ENTER_CALMODE	65555	Cannot put GG in Cal mode	Gas gauge could not be put in Calibration mode	Check Connections. Verify version compatibility between bqMtester software and Module under Test.
ERR_CUSTOM_FUNC	65556	User defined function returned error		
BAD_FILE_FORMAT	65557	Header bad or format bad	Bad image file format	
ERR_WRITE_MFG_DATA	65558	Failed to write manufacturer data	Data Flash Failure	Module Repair/Retry Test
ERR_READ_DEV_VER	65559	Communication error reading device version	Hardware incompatibility	Check Connections. Verify version compatibility between bqMtester software and Module under Test.
CAL_VOLT_LESSTHANZERO	65600	Calibration voltage must be greater than 0	On screen values incorrect	Verify VTI and Configuration Settings
CAL_TEMP_LESSTHANZERO	65601	Calibration current must be greater than 0	On screen values incorrect	Verify VTI and Configuration Settings
CAL_CURR_LESSTHANZERO	65602	Calibration current must be greater than 0	On screen values incorrect	Verify VTI and Configuration Settings
WRITEFLASH_ROM_FAILED	65560	Failed to write flash while in ROM mode		
SENSE_RES_CAL_HIGH	65570	Sense resistor value too high in post cal checks	Senser Resistor Hardware Failure, Connection Problem, Setting Problem, or HPA169 Power Supply Problem	Verify Sense Resistor Value, check current supply connections, and verify VTI and Configuration Settings. Try increasing tolerances if possible
SENSE_RES_CAL_LOW	65571	Sense resistor value too low in post cal checks	Senser Resistor Hardware Failure, Connection Problem, Setting Problem, or HPA169 Power Supply Problem	Verify Sense Resistor Value, check current supply connections, and verify VTI and Configuration Settings. Try increasing tolerances if possible
VOLT_CAL_HIGH	65580	voltage value too high in post cal checks	Module hardware failure, HPA169 Voltage power supply problem or Configuration failure	Verify Voltage circuit, voltage power supply, VTI, and Configuration Settings. Try increasing tolerances if possible
VOLT_CAL_LOW	65581	voltage value too low in post cal checks	Module hardware failure, HPA169 Voltage power supply problem or Configuration failure	Verify Voltage circuit, voltage power supply, VTI, and Configuration Settings. Try increasing tolerances if possible
TEMP_CAL_HIGH	65590	temperature value too high in post cal checks	Module hardware failure, HPA169 Temperature sensor Failure	Verify VTI settings, and Temperature sensor location
TEMP_CAL_LOW	65591	temperature value too low in post cal checks	Module hardware failure, HPA169 Temperature sensor Failure	Verify VTI settings, and Temperature sensor location
SEAL_CMD_FAILED	65610	Seal command failed	Communication Failure	Check Connections. Verify version compatibility between bqMtester software and Module under Test.
ERR_READ_CB_INT_TEMP_SENSOR	65611	Error reading internal temperature sensor on HPA169 calibration board	Temperature sensor failure	Verify HPA169 calibration board temperature sensor connections or replace sensor
ERR_READ_CB_EXT_TEMP_SENSOR	65612	Error reading external temperature sensor on HPA169 calibration board	Temperature sensor failure	Verify HPA169 calibration board temperature sensor connections or replace sensor
ERR_CALIBRATION_OUTOFSPEC	65613	Time to recalibrate HPA169 calibration board	VTI calibration Timer expired	Calibrate VTI settings
ERR_TEST_ROUTINE	65614	Reserved		

Revision History

NOTE: Page numbers for previous revisions may differ from page numbers in the current version.

Changes from B Revision (October 2013) to C Revision	Page
• Added <i>NOTE</i> : regarding use of EVMs for production.	3
• Updated document to reflect non-availability of Visual Basic source code.	3
• Updated document to reflect policy changes.	4

IMPORTANT NOTICE AND DISCLAIMER

TI PROVIDES TECHNICAL AND RELIABILITY DATA (INCLUDING DATASHEETS), DESIGN RESOURCES (INCLUDING REFERENCE DESIGNS), APPLICATION OR OTHER DESIGN ADVICE, WEB TOOLS, SAFETY INFORMATION, AND OTHER RESOURCES "AS IS" AND WITH ALL FAULTS, AND DISCLAIMS ALL WARRANTIES, EXPRESS AND IMPLIED, INCLUDING WITHOUT LIMITATION ANY IMPLIED WARRANTIES OF MERCHANTABILITY, FITNESS FOR A PARTICULAR PURPOSE OR NON-INFRINGEMENT OF THIRD PARTY INTELLECTUAL PROPERTY RIGHTS.

These resources are intended for skilled developers designing with TI products. You are solely responsible for (1) selecting the appropriate TI products for your application, (2) designing, validating and testing your application, and (3) ensuring your application meets applicable standards, and any other safety, security, or other requirements. These resources are subject to change without notice. TI grants you permission to use these resources only for development of an application that uses the TI products described in the resource. Other reproduction and display of these resources is prohibited. No license is granted to any other TI intellectual property right or to any third party intellectual property right. TI disclaims responsibility for, and you will fully indemnify TI and its representatives against, any claims, damages, costs, losses, and liabilities arising out of your use of these resources.

TI's products are provided subject to TI's Terms of Sale (www.ti.com/legal/termsofsale.html) or other applicable terms available either on ti.com or provided in conjunction with such TI products. TI's provision of these resources does not expand or otherwise alter TI's applicable warranties or warranty disclaimers for TI products.

Mailing Address: Texas Instruments, Post Office Box 655303, Dallas, Texas 75265
Copyright © 2020, Texas Instruments Incorporated