

High PSRR, Low Noise μ Cap Triple LDO

Features

- Input Voltage Range: +2.25V to +5.5V
- 70 dB PSRR
- Stable with Ceramic Output Capacitor
- High Output Accuracy:
 - $\pm 1.0\%$ Initial Accuracy
 - $\pm 2.0\%$ over Temperature
- Low Dropout Voltage of 100 mV @ 150 mA
- Low Quiescent Current: 110 μ A per Regulator
- Fast Turn-On Time: 30 μ s
- Zero Off-Mode Current
- Thermal Shutdown Protection
- Current Limit Protection
- Tiny 16-Pin 4 mm x 4 mm QFN Package

Applications

- Cellular Phones
- PCs and Peripherals
- Wireless LAN Cards
- PDAs
- GPS

General Description

The MIC2215 is a high performance, triple LDO voltage regulator, with each regulator capable of providing 250 mA continuous output current.

Ideal for battery-operated applications, the MIC2215 offers 1% initial accuracy, extremely low dropout voltage (100 mV @ 150 mA), and low ground current at light load (typically 110 μ A per regulator). Equipped with a noise bypass pin and featuring very high power supply ripple rejection (PSRR) of up to 80 dB, the MIC2215 provides the lowest noise and highest efficiency solution for RF applications in portable electronics such as cellular phones and wireless LAN applications.

Equipped with TTL logic-compatible enable pins, each of the regulators in the MIC2215 can be put into a zero current off mode where the supply current is much less than 1 μ A when all the regulators are disabled. The MIC2215 is a μ Cap design, which enables a stable output with small ceramic output capacitors, reducing both cost and required board space for output bypassing.

The MIC2215 is available in the miniature 16-lead, 4 mm x 4 mm QFN package.

Package Types

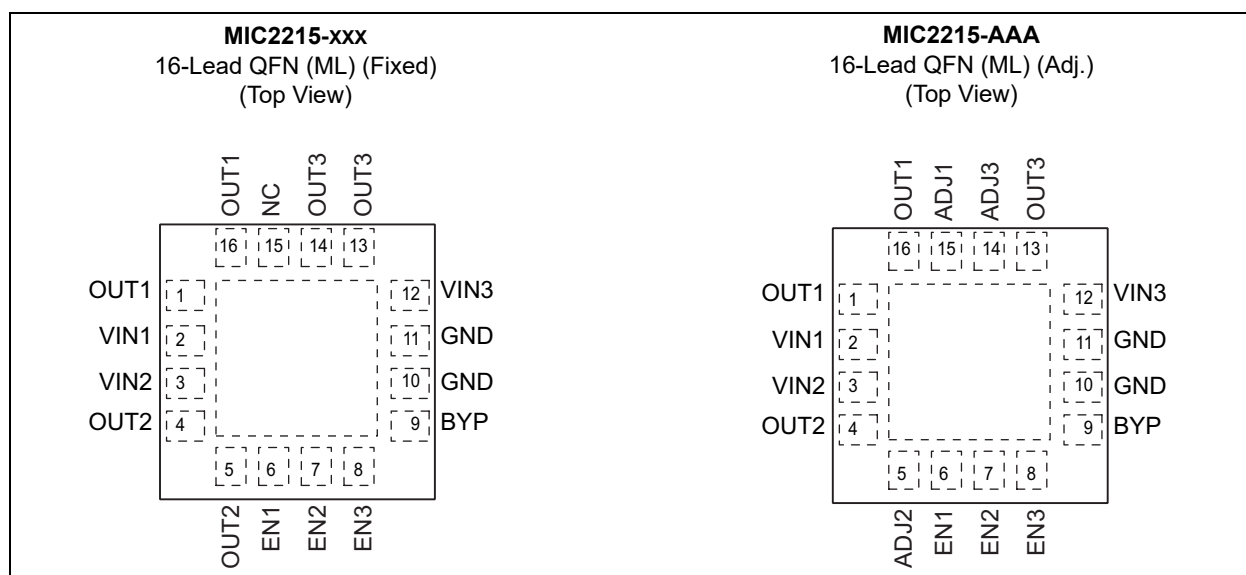

MIC2215

Typical Application Circuit

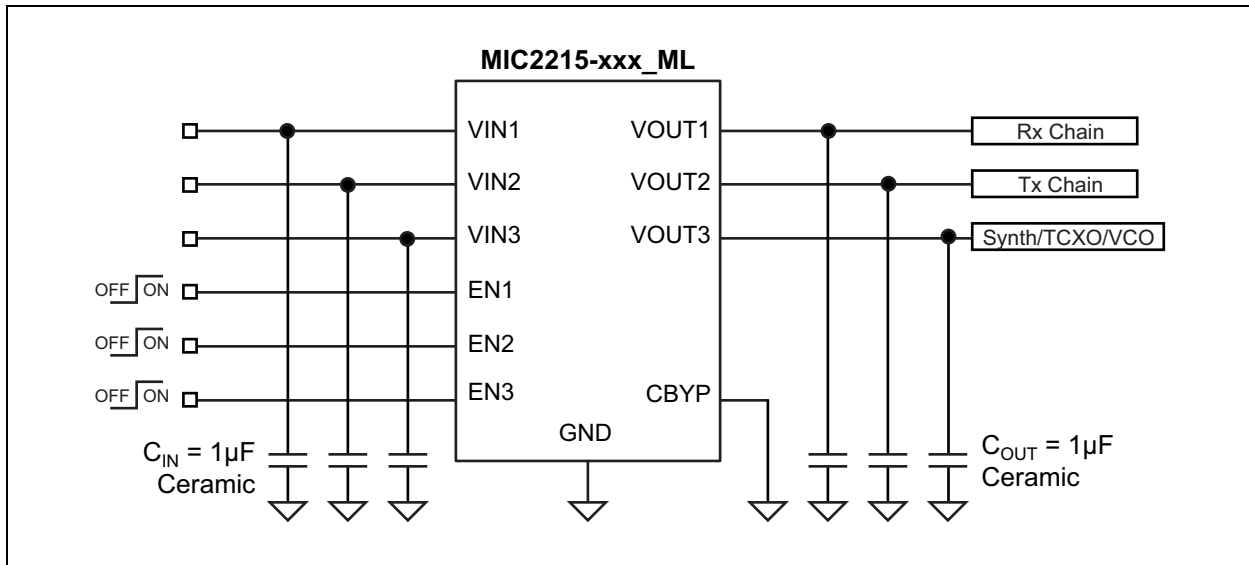

Functional Block Diagrams

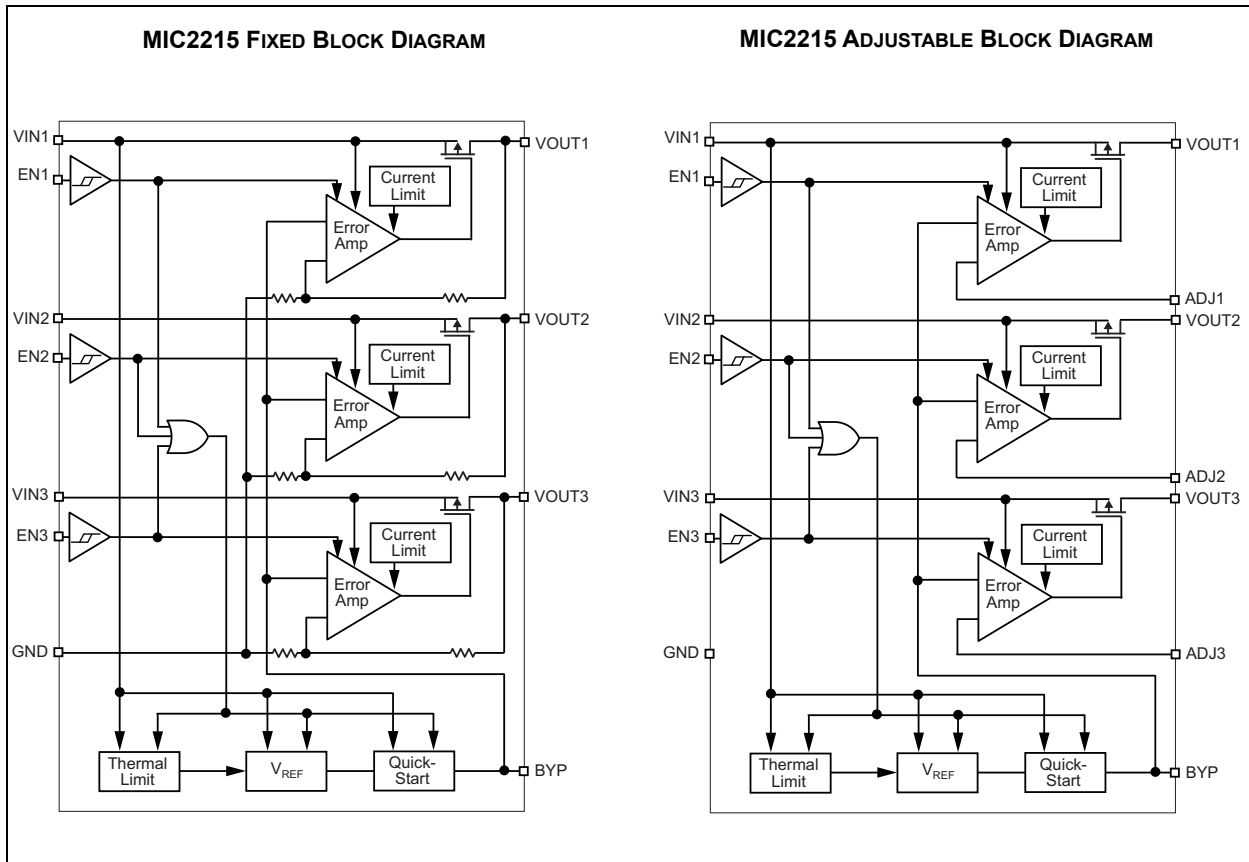

1.0 ELECTRICAL CHARACTERISTICS

Absolute Maximum Ratings †

| | |
|-----------------------------|--------------------|
| Supply Voltage (V_{IN}) | 0V to +7V |
| Enable Voltage (V_{EN}) | 0V to +7V |
| Power Dissipation (Note 1) | Internally Limited |
| ESD Rating | Note 2 |

Operating Ratings ††

| | |
|---------------------------------------|---------------------|
| Supply Voltage (V_{IN1}) | +2.25V to +5.5V |
| Supply Voltage (V_{IN2}, V_{IN3}) | +2.25V to V_{IN1} |
| Enable Voltage (V_{EN}) | 0V to V_{IN1} |

† **Notice:** Stresses above those listed under “Absolute Maximum Ratings” may cause permanent damage to the device. This is a stress rating only and functional operation of the device at those or any other conditions above those indicated in the operational sections of this specification is not intended. Exposure to maximum rating conditions for extended periods may affect device reliability.

†† **Notice:** The device is not guaranteed to function outside its operating ratings.

Note 1: The maximum allowable power dissipation of any T_A (ambient temperature) is $P_{D(MAX)} = (T_{J(MAX)} - T_A) + \theta_{JA}$. Exceeding the maximum allowable power dissipation will result in excessive die temperature, and the regulator will go into thermal shutdown.

2: Devices are ESD sensitive. Handling precautions recommended.

ELECTRICAL CHARACTERISTICS

Electrical Characteristics: $V_{IN1} = V_{IN2} = V_{IN3} = V_{OUT}$ (highest nominal) + 1.0V; $C_{OUT} = 1.0 \mu\text{F}$, $I_{OUT} = 100 \mu\text{A}$; $T_J = +25^\circ\text{C}$, **bold** values indicate $-40^\circ\text{C} \leq T_J \leq +125^\circ\text{C}$ unless noted. Note 1

| Parameter | Sym. | Min. | Typ. | Max. | Units | Conditions |
|--|-----------|-----------|-------|------------|---------------|--|
| Output Voltage Accuracy | — | -1 | — | 1 | % | — |
| | | -2 | — | 2 | | |
| Output Voltage Temperature Coefficient | — | — | 40 | — | ppm/°C | — |
| Line Regulation | — | — | 0.015 | 0.3 | %/V | $V_{IN} = V_{OUT} + 1\text{V to } 5.5\text{V}$ |
| Load Regulation | — | — | 0.3 | 0.5 | % | $I_{OUT} = 100 \mu\text{A to } 250 \text{ mA}$ |
| | | — | — | 0.7 | | Valid only for $V_{OUT} = 1.8\text{V}$ |
| Dropout Voltage | V_{DO} | — | 2 | — | mV | $I_{OUT} = 100 \mu\text{A}$ |
| | | — | 32 | — | | $I_{OUT} = 50 \text{ mA}$ |
| | | — | 63 | — | | $I_{OUT} = 100 \text{ mA}$ |
| | | — | 100 | 150 | | $I_{OUT} = 150 \text{ mA}$ |
| | | — | 170 | 275 | | $I_{OUT} = 250 \text{ mA}$ |
| Ground Current | I_{GND} | — | 280 | 400 | μA | $I_{OUT1} = I_{OUT2} = I_{OUT3} = 100 \mu\text{A}$ |
| | | — | 110 | 150 | | $I_{OUT1} = 100 \mu\text{A}; I_{OUT2}/I_{OUT3} = \text{off}$ |
| | | — | 420 | 550 | | $I_{OUT1} = I_{OUT2} = I_{OUT3} = 250 \text{ mA}$ |
| Quiescent Current | I_Q | — | 0.2 | 1 | μA | $V_{EN1} = V_{EN2} = V_{EN3} = 0\text{V}$ |

Note 1: Specification for packaged product only.

MIC2215

ELECTRICAL CHARACTERISTICS (CONTINUED)

Electrical Characteristics: $V_{IN1} = V_{IN2} = V_{IN3} = V_{OUT}$ (highest nominal) +1.0V; $C_{OUT} = 1.0 \mu\text{F}$, $I_{OUT} = 100 \mu\text{A}$; $T_J = +25^\circ\text{C}$, **bold** values indicate $-40^\circ\text{C} \leq T_J \leq +125^\circ\text{C}$ unless noted. [Note 1](#)

| Parameter | Sym. | Min. | Typ. | Max. | Units | Conditions |
|----------------------|-----------|------------|------|------------|---------------------|---|
| Ripple Rejection | PSRR | — | 70 | — | dB | $V_{IN} = V_{OUT} + 1.0\text{V}$; $I_{OUT} = 150 \text{ mA}$, $f = 0.1 \text{ kHz}$ to 1 kHz , $C_{BYP} = 0.1 \mu\text{F}$ |
| | | — | 60 | — | | $V_{IN} = V_{OUT} + 0.4\text{V}$; $I_{OUT} = 150 \text{ mA}$, $f = 0.1 \text{ kHz}$ to 1 kHz , $C_{BYP} = 0.1 \mu\text{F}$ |
| | | — | 45 | — | | $V_{IN} = V_{OUT} + 0.2\text{V}$; $I_{OUT} = 150 \text{ mA}$, $f = 0.1 \text{ kHz}$ to 1 kHz , $C_{BYP} = 0.1 \mu\text{F}$ |
| Current Limit | I_{LIM} | 350 | 700 | — | mA | $V_{OUT} = 0\text{V}$ (All regulators) |
| Output Voltage Noise | — | — | 30 | — | μV_{RMS} | $C_{BYP} = 0.1 \mu\text{F}$, $f = 10 \text{ Hz}$ to 100 kHz |
| Turn-On Time | t_{ON} | — | 30 | 100 | μs | $C_{BYP} = 0.01 \mu\text{F}$ |
| Enable Input | | | | | | |
| Enable Input Voltage | V_{EN} | — | — | 0.4 | V | Logic Low (Regulator shutdown) |
| | | 1.5 | — | — | | Logic High (Regulator enabled) |
| Enable Input Current | I_{EN} | — | 1.0 | — | μA | $V_{IL} < 0.4\text{V}$ (Regulator shutdown) |
| | | — | 0.01 | — | | $V_{IH} > 1.5\text{V}$ (Regulator enabled) |

Note 1: Specification for packaged product only.

TEMPERATURE SPECIFICATIONS

| Parameters | Sym. | Min. | Typ. | Max. | Units | Conditions |
|--------------------------------------|---------------|------|------|------|--------------------|------------------------|
| Temperature Ranges | | | | | | |
| Operating Junction Temperature Range | T_J | -40 | — | +125 | $^\circ\text{C}$ | Note 1 |
| Storage Temperature Range | T_S | -65 | — | +150 | $^\circ\text{C}$ | — |
| Lead Temperature | T_{LEAD} | — | — | +260 | $^\circ\text{C}$ | Soldering, 5 sec. |
| Package Thermal Resistance | | | | | | |
| Thermal Resistance, QFN 16-Ld | θ_{JA} | — | 45 | — | $^\circ\text{C/W}$ | — |

Note 1: The maximum allowable power dissipation is a function of ambient temperature, the maximum allowable junction temperature and the thermal resistance from junction to air (i.e., T_A , T_J , θ_{JA}). Exceeding the maximum allowable power dissipation will cause the device operating junction temperature to exceed the maximum +125 $^\circ\text{C}$ rating. Sustained junction temperatures above +125 $^\circ\text{C}$ can impact the device reliability.

2.0 TYPICAL PERFORMANCE CURVES

Note: The graphs and tables provided following this note are a statistical summary based on a limited number of samples and are provided for informational purposes only. The performance characteristics listed herein are not tested or guaranteed. In some graphs or tables, the data presented may be outside the specified operating range (e.g., outside specified power supply range) and therefore outside the warranted range.

$T_A = +25^\circ\text{C}$, unless otherwise noted.

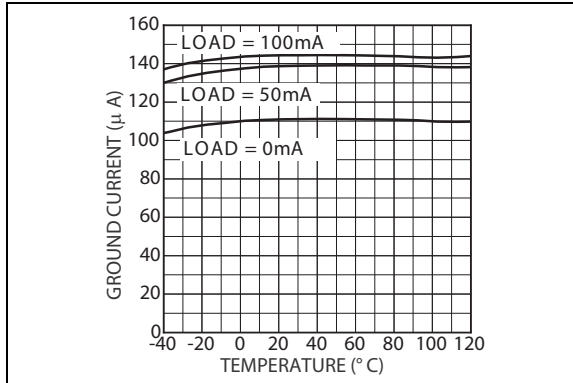

FIGURE 2-1: Ground Current vs. Temperature for LDO 1.

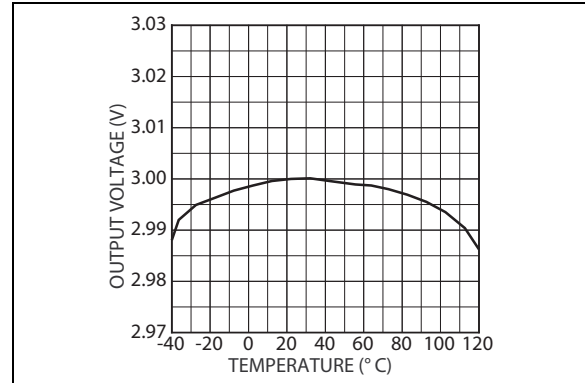

FIGURE 2-4: Output Voltage vs. Temperature for LDO 1.

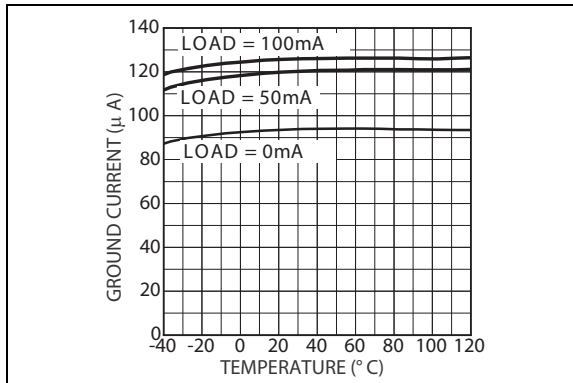

FIGURE 2-2: Ground Current vs. Temperature for LDO 2.

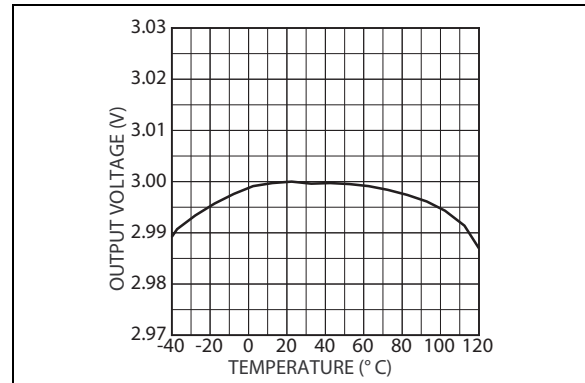

FIGURE 2-5: Output Voltage vs. Temperature for LDO 2.

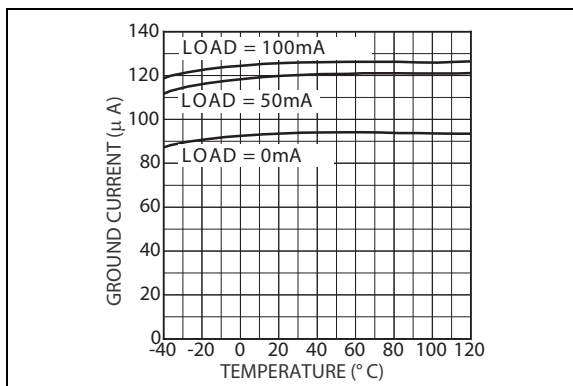

FIGURE 2-3: Ground Current vs. Temperature for LDO 3.

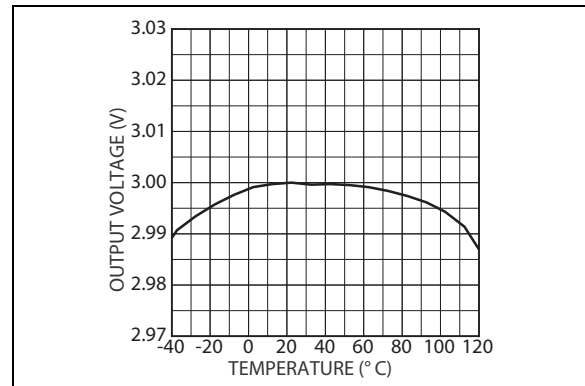

FIGURE 2-6: Output Voltage vs. Temperature for LDO 3.

MIC2215

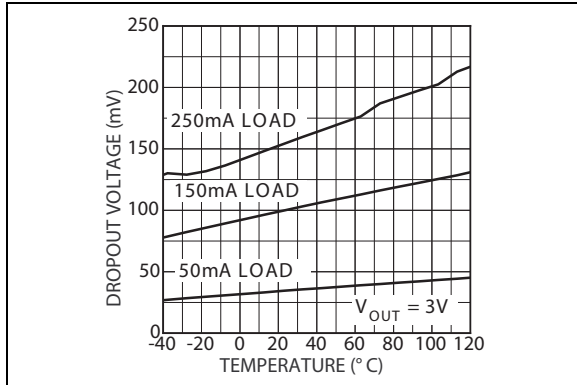

FIGURE 2-7: Dropout Voltage vs. Temperature for LDO 1.

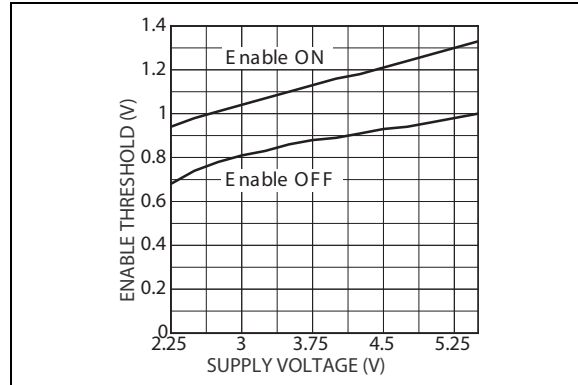

FIGURE 2-10: Enable Threshold vs. Supply Voltage for LDO 1.

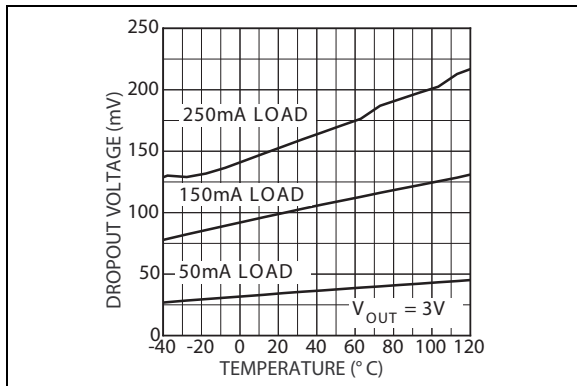

FIGURE 2-8: Dropout Voltage vs. Temperature for LDO 2.

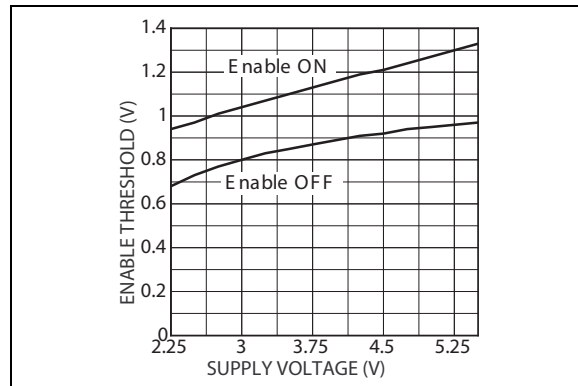

FIGURE 2-11: Enable Threshold vs. Supply Voltage for LDO 2.

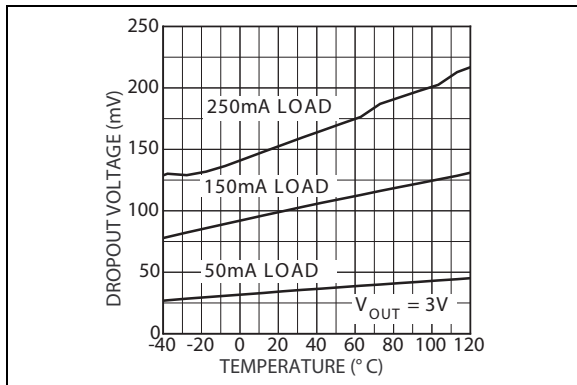

FIGURE 2-9: Dropout Voltage vs. Temperature for LDO 3.

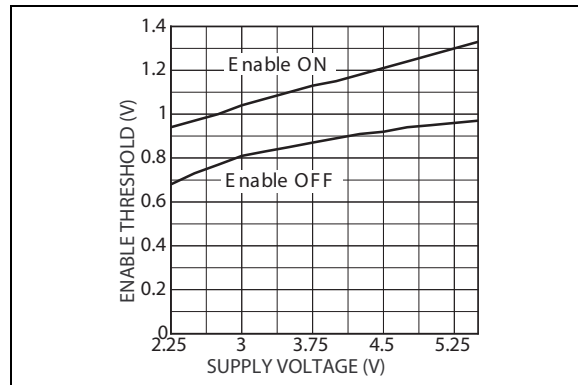

FIGURE 2-12: Enable Threshold vs. Supply Voltage for LDO 3.

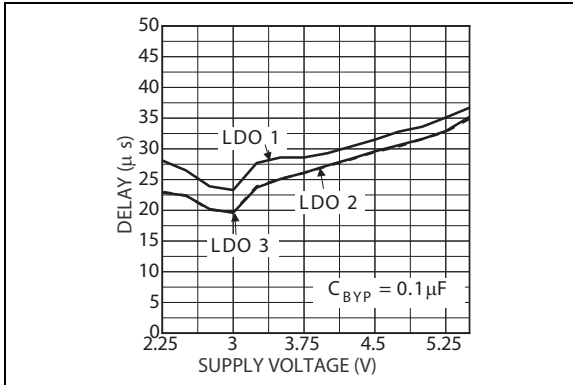

FIGURE 2-13: Enable Delay vs. Supply Voltage.

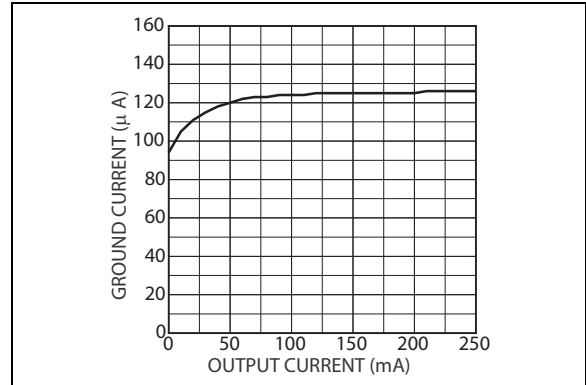

FIGURE 2-16: Ground Current vs. Load Current for LDO 3.

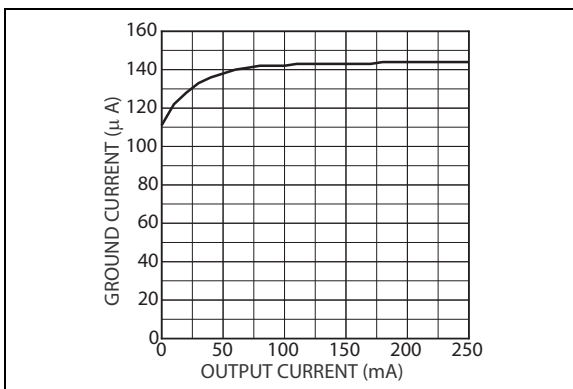

FIGURE 2-14: Ground Current vs. Load Current for LDO 1.

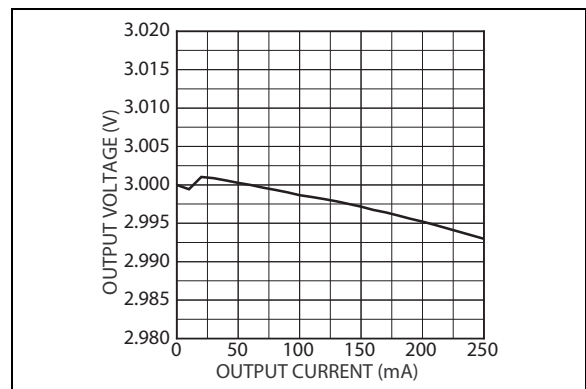

FIGURE 2-17: Load Regulation LDO 1.

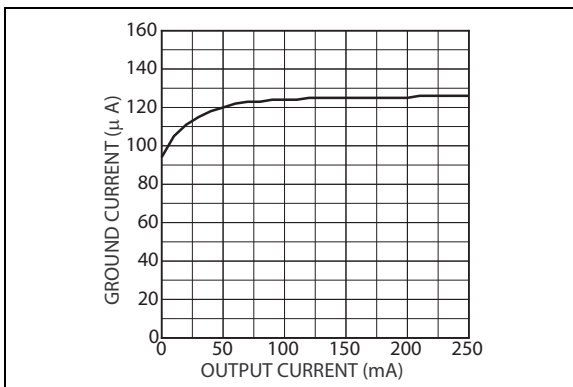

FIGURE 2-15: Ground Current vs. Load Current for LDO 2.

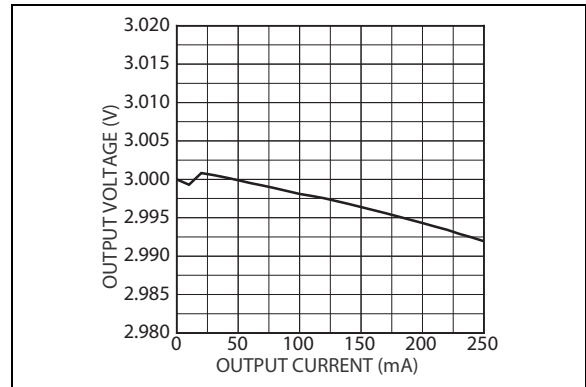

FIGURE 2-18: Load Regulation LDO 2.

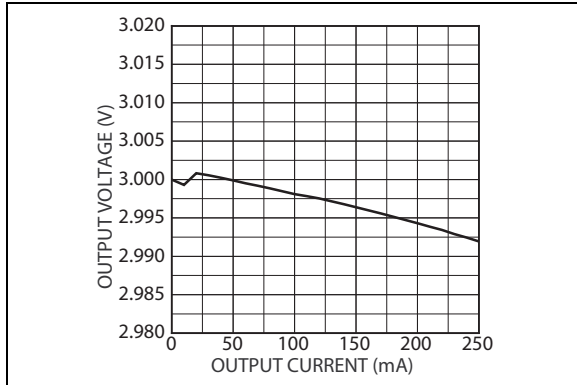

FIGURE 2-19: Load Regulation LDO 3.

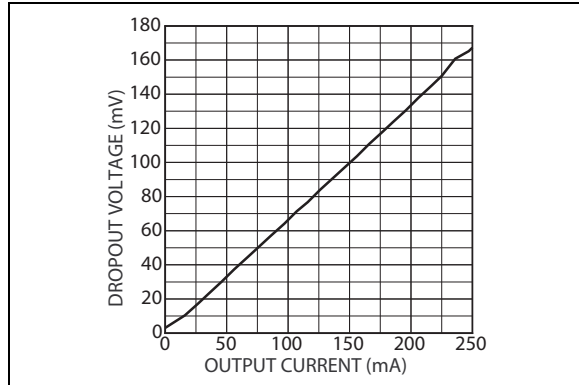

FIGURE 2-22: Dropout Voltage vs. Output Current for LDO 3.

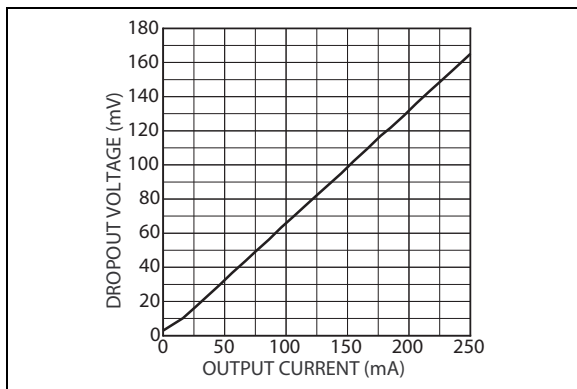

FIGURE 2-20: Dropout Voltage vs. Output Current for LDO 1.

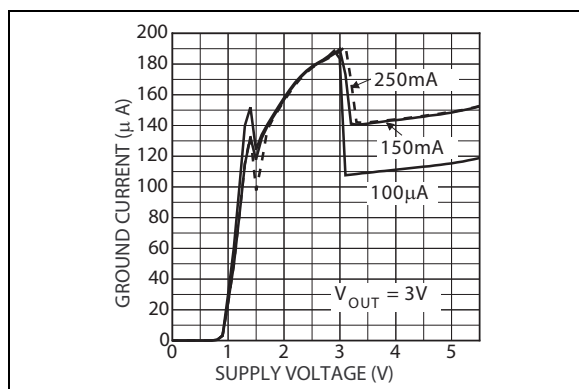

FIGURE 2-23: Ground Current vs. Supply Voltage for LDO 1.

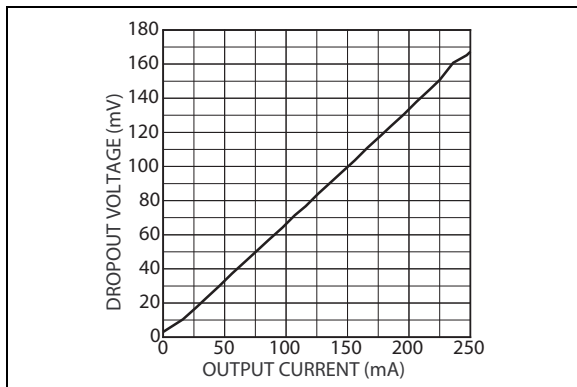

FIGURE 2-21: Dropout Voltage vs. Output Current for LDO 2.

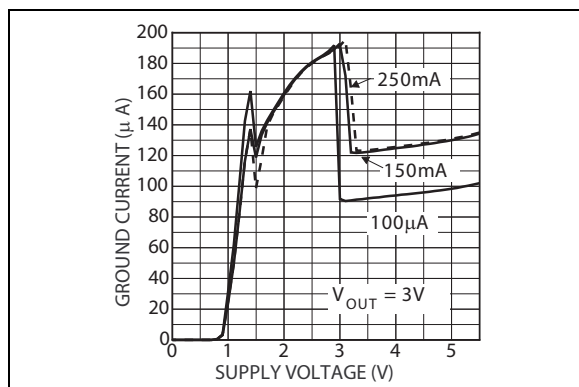

FIGURE 2-24: Ground Current vs. Supply Voltage for LDO 2.

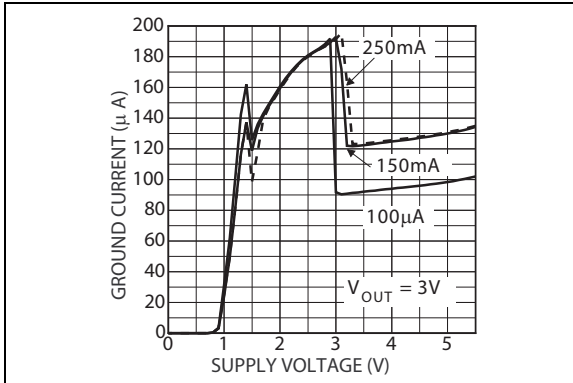

FIGURE 2-25: Ground Current vs. Supply Voltage for LDO 3.

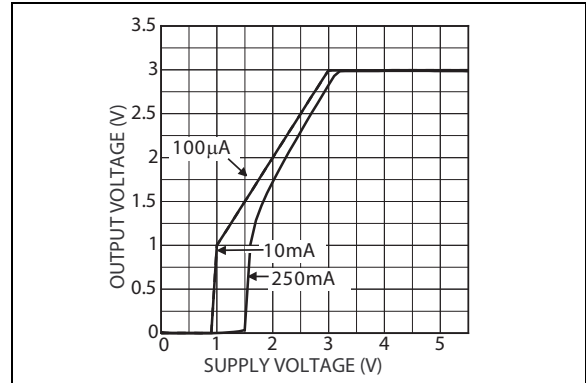

FIGURE 2-28: Output Voltage vs. Supply Voltage for LDO 3.

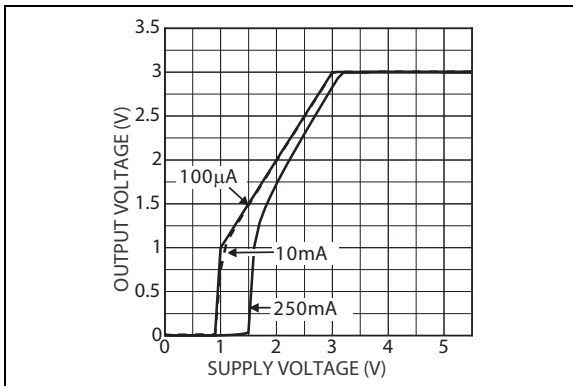

FIGURE 2-26: Output Voltage vs. Supply Voltage for LDO 1.

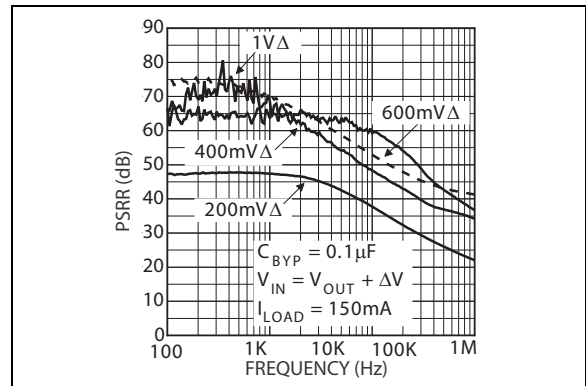

FIGURE 2-29: Power Supply Rejection Ratio, $3V_{OUT}$.

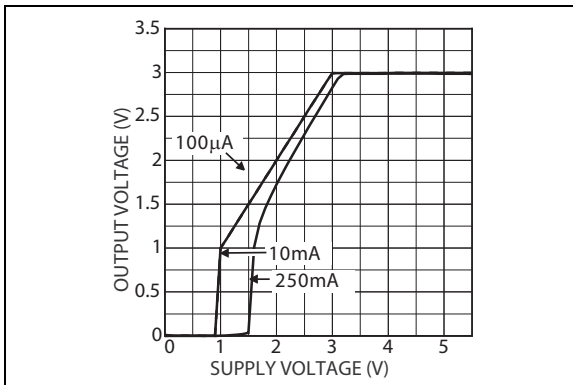

FIGURE 2-27: Output Voltage vs. Supply Voltage for LDO 2.

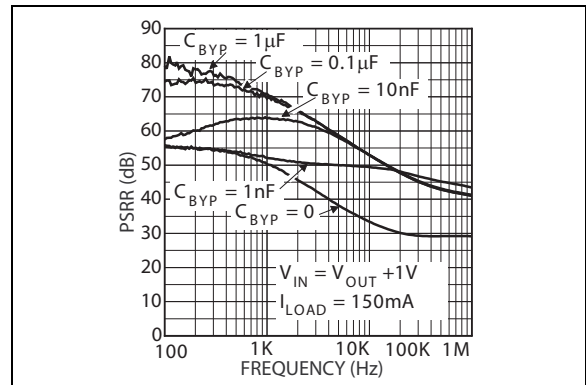

FIGURE 2-30: Power Supply Rejection Ratio vs. C_{BYPASS} .

MIC2215

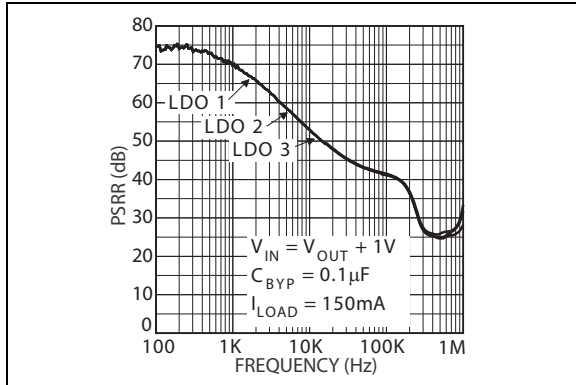

FIGURE 2-31: Power Supply Rejection Ratio.

3.0 PIN DESCRIPTIONS

The descriptions of the pins are listed in [Table 3-1](#).

TABLE 3-1: PIN FUNCTION TABLE

| Pin Number | Pin Name | Description |
|------------|---------------|---|
| 1 | VOUT1 | Output voltage of regulator 1 (250 mA). Connect externally to pin 16. |
| 2 | VIN1 | Supply input of regulator 1 (highest input voltage required for common circuitry). |
| 3 | VIN2 | Supply input of regulator 2. |
| 4 | VOUT2 | Output voltage of regulator 2 (250 mA). For fixed output device, connect pins 4 and 5 externally. |
| 5 | VOUT2 (Fixed) | Output voltage of regulator 2 (250 mA). For fixed output device, connect pins 4 and 5 externally. |
| | ADJ2 (Adj.) | Adjust Input. Feedback input for regulator 2. |
| 6 | EN1 | Enable input to regulator 1. Enables regulator 1 output. Active-high input. High = on, low = off. |
| 7 | EN2 | Enable input to regulator 2. Enables regulator 2 output. Active-high input. High = on, low = off. |
| 8 | EN3 | Enable input to regulator 3. Enables regulator 3 output. Active-high input. High = on, low = off. |
| 9 | CBYP | Reference Bypass: Connect external 0.01 μ F to GND to reduce output noise. May be left open. |
| 10 | GND | Ground. |
| 11 | GND | Ground. |
| 12 | VIN3 | Supply input of regulator 3. |
| 13 | VOUT3 | Output voltage of regulator 3 (250 mA). For fixed output device, connect pins 13 and 14 externally. |
| 14 | VOUT3 (Fixed) | Output voltage of regulator 3 (250 mA). For fixed output device, connect pins 13 and 14 externally. |
| | ADJ3 (Adj.) | Adjust Input. Feedback input for regulator 3. |
| 15 | NC (Fixed) | No Connect. Not internally connected. |
| | ADJ1 (Adj.) | Adjust Input. Feedback input for regulator 1. |
| 16 | VOUT1 | Output voltage of regulator 1 (250 mA). Connect externally to pin 1. |
| EP | GND | Ground. |

MIC2215

4.0 FUNCTIONAL DESCRIPTION

The MIC2215 is a triple, low-noise CMOS LDO. Designed specifically for noise-critical applications in handheld or battery-powered devices, the MIC2215 comes equipped with a noise reduction feature to filter the output noise via an external capacitor. Other features of the MIC2215 include a separate logic compatible enable pin for each channel, current limit, thermal shutdown, and ultra-fast transient response, all within a small QFN package.

The MIC2215 is specifically designed to work with low-ESR ceramic capacitors, reducing the amount of board space necessary for power applications, which is critical in handheld wireless devices.

5.0 APPLICATION INFORMATION

5.1 Enable/Shutdown

The MIC2215 comes with three active-high enable pins that allow each individual regulator to be either disabled or enabled. Forcing the enable pin low disables the respective regulator and sends it into a zero off-mode current state. In this state, current consumed by the individual regulator goes nearly to zero. This is true for both regulators 2 and 3. Regulator 1's input supply pin is also used to power the internal reference. When any regulator, either 1, 2, or 3, is enabled, an additional 20 μ A for the reference will be drawn through VIN1. All three must be disabled to enter the zero current off-mode state. Forcing the enable pin high enables each respective output voltage. This part is CMOS and none of the enable pins can be left floating; a floating enable pin may cause an indeterminate state on the output.

5.2 Input Capacitor

The MIC2215 is a high performance, high bandwidth device. Therefore, it requires a well-bypassed input supply for optimal performance. A small 0.1 μ F capacitor placed close to the input is recommended to aid in noise performance. Low-ESR ceramic capacitors provide optimal performance at a minimum of space. Additional high-frequency capacitors, such as small valued NPO dielectric type capacitors, help to filter out high frequency noise and are good practice in any RF-based circuit.

5.3 Output Capacitor

The MIC2215 requires an output capacitor for stability. The design requires 1 μ F or greater on the output to maintain stability. The design is optimized for use with low-ESR ceramic chip capacitors. X7R/X5R dielectric-type ceramic capacitors are recommended because of their temperature performance. X7R-type capacitors change capacitance by 15% over their

operating temperature range and are the most stable type of ceramic capacitors. Z5U and Y5V dielectric capacitors change value by as much as 50% and 60%, respectively, over their operating temperature ranges. To use a ceramic chip capacitor with Y5V dielectric, the value must be much higher than an X7R ceramic capacitor to ensure the same minimum capacitance over the equivalent operating temperature range.

5.4 Bypass Pin

A capacitor can be placed from the noise bypass pin to ground to reduce output voltage noise. The capacitor bypasses the internal reference. There is one single internal reference shared by each output, therefore the bypassing affects each regulator. A 0.1 μ F capacitor is recommended for applications that require low-noise outputs. The bypass capacitor can be increased, further reducing noise and improving PSRR. Turn-on time increases slightly with respect to bypass capacitance.

5.5 Internal Reference

The internal band gap, or reference, is powered from the VIN1 input. Due to some of the input noise (PSRR) contributions being imposed on the band gap, it is important to make V_{IN1} as clean as possible with good bypassing close to the input.

5.6 Multiple Input Supplies

The MIC2215 can be used with multiple input supplies when desired. The only requirement, aside from maintaining the voltages within the operating ranges, is that V_{IN1} always remains the highest voltage potential.

5.7 No-Load Stability

The MIC2215 will remain stable and in regulation with no load, unlike many other voltage regulators. This is especially important in CMOS RAM keep-alive applications.

5.8 Thermal Considerations

The MIC2215 is designed to provide up to 250 mA of current per channel in a very small package. Maximum power dissipation can be calculated based on the output current and the voltage drop across the part. To determine the maximum power dissipation of the package, use the junction-to-ambient thermal resistance of the device and the following basic equation:

EQUATION 5-1:

$$P_{D(MAX)} = (T_{J(MAX)} - T_A) \div \theta_{JA}$$

The maximum junction temperature of the die ($T_{J(MAX)}$) is +125° and is also the ambient operating temperature (T_A). θ_{JA} is layout dependent; the junction-to-ambient thermal resistance for the MIC2215 can be found in the [Temperature Specifications](#) section.

The actual power dissipation of the regulator circuit can be determined using the following equation:

EQUATION 5-2:

$$P_{DTOTAL} = P_{DLDO1} + P_{DLDO2} + P_{DLDO3}$$

Where:

$$P_{DLDO1} = (V_{IN1} - V_{OUT1}) \times I_{OUT1}$$

$$P_{DLDO2} = (V_{IN2} - V_{OUT2}) \times I_{OUT2}$$

$$P_{DLDO3} = (V_{IN3} - V_{OUT3}) \times I_{OUT3}$$

Substituting $P_{D(MAX)}$ for P_D and solving for the operating conditions that are critical to the application will give the maximum operating conditions for the regulator circuit. For example, when operating the MIC2215 at 60°C with a minimum footprint layout, the maximum load currents can be calculated as follows:

EQUATION 5-3:

$$P_{D(MAX)} = (125^\circ C - 60^\circ C) \div 43^\circ C/W = 1.511W$$

The junction-to-ambient thermal resistance for the minimum footprint is 43°C/W. The maximum power dissipation must not be exceeded for proper operation. Using a lithium-ion battery as the supply voltage (2.8V/250 mA for channel 1, 3V/100 mA for channel 2, and 2.8V/50 mA for channel 3), maximum power can be calculated as follows:

EQUATION 5-4:

$$P_{DLDO1} = (4.2V - 2.8V) \times 250mA$$

$$P_{DLDO1} = 350mW$$

$$P_{DLDO2} = (4.2V - 3.0V) \times 100mA$$

$$P_{DLDO2} = 120mW$$

$$P_{DLDO3} = (4.2V - 2.8V) \times 50mA$$

$$P_{DLDO3} = 70mW$$

$$P_{DTOTAL} = 350mW + 120mW + 70mW$$

$$P_{DTOTAL} = 540mW$$

The calculation shows that the device is well below the maximum allowable power dissipation of 1.511W for a 60°C ambient temperature. After the maximum power dissipation has been calculated, it is always good

practice to calculate the maximum ambient temperature for a 125°C junction temperature. Calculating maximum ambient temperature follows:

EQUATION 5-5:

$$T_{A(MAX)} = T_{J(MAX)} - (P_D \times \theta_{JA})$$

$$T_{A(MAX)} = 125^\circ C - (540mW \times 43^\circ C/W)$$

$$T_{A(MAX)} = 101^\circ C$$

For more information, please refer to the [Designing with Low-Dropout Voltage Regulators Handbook](#).

5.9 Adjustable Regulator Application

Adjustable regulators use the ratio of two resistors to multiply the reference voltage to produce the desired output voltage. The MIC2215 can be adjusted from 1.25V to 5.5V, the maximum $V_{DROPOUT}$, by using two external resistors ([Figure 5-1](#)). The resistors set the output voltage based on the following equation:

EQUATION 5-6:

$$V_{OUT} = V_{REF} \times \left(1 + \frac{R1}{R2}\right)$$

Where:

$$V_{REF} = 1.25V$$

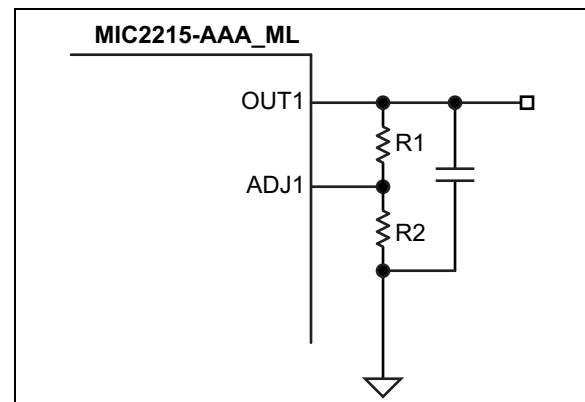

FIGURE 5-1: Adjustable Output.

MIC2215

6.0 PACKAGING INFORMATION

6.1 Package Marking Information

16-Lead QFN*

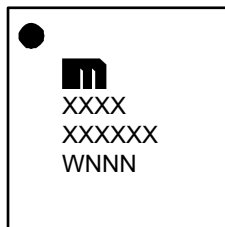

Example

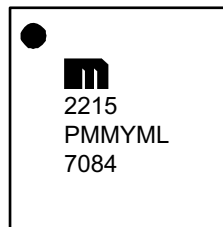

| | | |
|----------------|--|--|
| Legend: | XX...X | Product code or customer-specific information |
| | Y | Year code (last digit of calendar year) |
| | YY | Year code (last 2 digits of calendar year) |
| | WW | Week code (week of January 1 is week '01') |
| | NNN | Alphanumeric traceability code |
| | (e3) | Pb-free JEDEC® designator for Matte Tin (Sn) |
| | * | This package is Pb-free. The Pb-free JEDEC designator (e3) can be found on the outer packaging for this package. |
| | •, ▲, ▼ | Pin one index is identified by a dot, delta up, or delta down (triangle mark). |
| Note: | In the event the full Microchip part number cannot be marked on one line, it will be carried over to the next line, thus limiting the number of available characters for customer-specific information. Package may or may not include the corporate logo. | |
| | Underbar (¯) and/or Overbar (˘) symbol may not be to scale. | |

Note: If the full seven-character YYWWNNN code cannot fit on the package, the following truncated codes are used based on the available marking space:
6 Characters = YWWNNN; 5 Characters = WWNNN; 4 Characters = WNNN; 3 Characters = NNN;
2 Characters = NN; 1 Character = N

16-Lead 4 mm x 4 mm QFN Package Outline and Recommended Land Pattern

TITLE

16 LEAD QFN 4.0 x 4.0 mm PACKAGE OUTLINE & RECOMMENDED LAND PATTERN

| DRAWING # | QFN44-16LD-PL-1 | UNIT | MM |
|-----------|-----------------|------|----|
|-----------|-----------------|------|----|

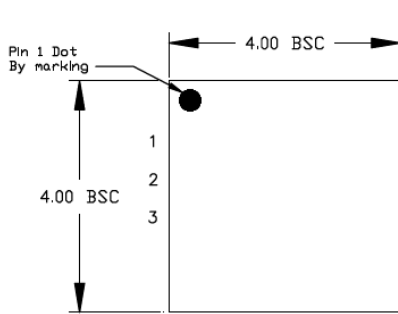

TOP VIEW

NOTE: 1, 2, 3

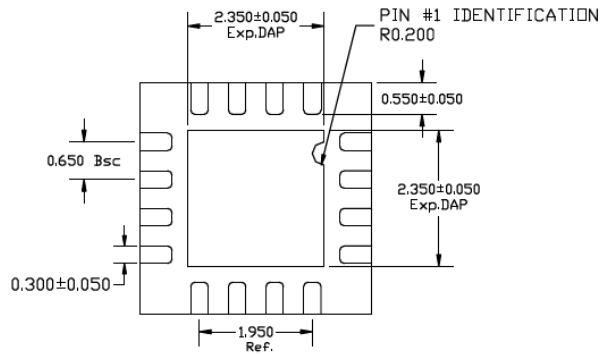

BOTTOM VIEW

NOTE: 1, 2

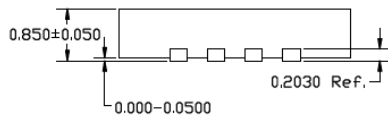

SIDE VIEW

NOTE: 1, 2

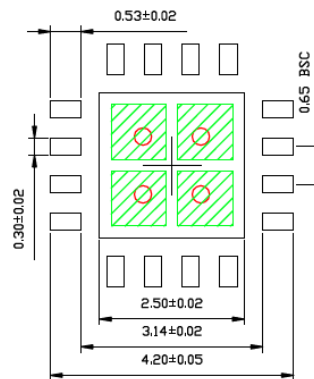

RECOMMENDED LAND PATTERN

NOTE: 4, 5

NOTE:

1. MAX PACKAGE WARPAGE IS 0.05MM
2. MAX ALLOWABLE BURR IS 0.076MM IN ALL DIRECTIONS
3. PIN #1 IS ON TOP WILL BE LASER MARKED
4. GREEN RECTANGLES (SHADED AREA) REPRESENT STENCIL OPENING ON EXPOSED AREA. SIZE IS 0.95X0.95MM, 1.15MM PITCH SPACING
5. RED CIRCLES REPRESENT THERMAL VIAS & SHOULD BE CONNECTED TO GND FOR MAX PERFORMANCE. 0.30 - 0.35 MM RECOMMENDED DIAMETER, 1.0MM PITCH SPACING

Note: For the most current package drawings, please see the Microchip Packaging Specification located at <http://www.microchip.com/packaging>.

MIC2215

NOTES:

APPENDIX A: REVISION HISTORY

Revision A (November 2019)

- Converted Micrel document MIC2215 to Microchip data sheet template DS20006247A.
- Minor grammatical text changes throughout.
- Added additional value and condition for Load Regulation in the [Electrical Characteristics](#) table.

Revision B (March 2022)

- Added new required note below the legend (for APID and some other former Micrel BUs) in [Section 6.1, Package Marking Information](#) to help clarify the marking codes.

MIC2215

NOTES:

PRODUCT IDENTIFICATION SYSTEM

To order or obtain information, e.g., on pricing or delivery, contact your local Microchip representative or sales office.

| <u>Device</u> | <u>-X</u> | <u>X</u> | <u>X</u> | <u>X</u> | <u>XX</u> | <u>-XX</u> | | | | | | | | | | | | | | | | | | | | | | | | | | | | | | | | | | | | | | | | | | | | | | | | | | | | | | | | | | | | | | | | | | |
|--|-------------------|-------------------|-------------------|----------------------------|-----------|---------------|---|---|------------|---|---|------|---|---|------|---|---|------|---|---|-------|---|---|------|---|---|------|---|---|------|---|---|------|---|---|------|---|---|-------|---|---|------|---|---|------|---|---|-------|---|---|------|---|---|------|---|---|------|---|---|------|---|---|------|---|---|------|---|---|------|---|---|------|
| Part No. | V _{OUT1} | V _{OUT2} | V _{OUT3} | Junction Temp. Range | Package | Media Type | | | | | | | | | | | | | | | | | | | | | | | | | | | | | | | | | | | | | | | | | | | | | | | | | | | | | | | | | | | | | | | | | | |
| Device: MIC2215: High PSRR, Low Noise μ Cap Triple LDO | | | | | | | | | | | | | | | | | | | | | | | | | | | | | | | | | | | | | | | | | | | | | | | | | | | | | | | | | | | | | | | | | | | | | | | | |
| V_{OUT1}, V_{OUT2}, V_{OUT3} Options: <table> <tr><td>A</td><td>=</td><td>Adjustable</td></tr> <tr><td>F</td><td>=</td><td>1.5V</td></tr> <tr><td>W</td><td>=</td><td>1.6V</td></tr> <tr><td>G</td><td>=</td><td>1.8V</td></tr> <tr><td>D</td><td>=</td><td>1.85V</td></tr> <tr><td>Y</td><td>=</td><td>1.9V</td></tr> <tr><td>H</td><td>=</td><td>2.0V</td></tr> <tr><td>E</td><td>=</td><td>2.1V</td></tr> <tr><td>J</td><td>=</td><td>2.5V</td></tr> <tr><td>K</td><td>=</td><td>2.6V</td></tr> <tr><td>I</td><td>=</td><td>2.65V</td></tr> <tr><td>L</td><td>=</td><td>2.7V</td></tr> <tr><td>M</td><td>=</td><td>2.8V</td></tr> <tr><td>N</td><td>=</td><td>2.85V</td></tr> <tr><td>O</td><td>=</td><td>2.9V</td></tr> <tr><td>P</td><td>=</td><td>3.0V</td></tr> <tr><td>Q</td><td>=</td><td>3.1V</td></tr> <tr><td>R</td><td>=</td><td>3.2V</td></tr> <tr><td>S</td><td>=</td><td>3.3V</td></tr> <tr><td>T</td><td>=</td><td>3.4V</td></tr> <tr><td>U</td><td>=</td><td>3.5V</td></tr> <tr><td>V</td><td>=</td><td>3.6V</td></tr> </table> | | | | | | | A | = | Adjustable | F | = | 1.5V | W | = | 1.6V | G | = | 1.8V | D | = | 1.85V | Y | = | 1.9V | H | = | 2.0V | E | = | 2.1V | J | = | 2.5V | K | = | 2.6V | I | = | 2.65V | L | = | 2.7V | M | = | 2.8V | N | = | 2.85V | O | = | 2.9V | P | = | 3.0V | Q | = | 3.1V | R | = | 3.2V | S | = | 3.3V | T | = | 3.4V | U | = | 3.5V | V | = | 3.6V |
| A | = | Adjustable | | | | | | | | | | | | | | | | | | | | | | | | | | | | | | | | | | | | | | | | | | | | | | | | | | | | | | | | | | | | | | | | | | | | | | |
| F | = | 1.5V | | | | | | | | | | | | | | | | | | | | | | | | | | | | | | | | | | | | | | | | | | | | | | | | | | | | | | | | | | | | | | | | | | | | | | |
| W | = | 1.6V | | | | | | | | | | | | | | | | | | | | | | | | | | | | | | | | | | | | | | | | | | | | | | | | | | | | | | | | | | | | | | | | | | | | | | |
| G | = | 1.8V | | | | | | | | | | | | | | | | | | | | | | | | | | | | | | | | | | | | | | | | | | | | | | | | | | | | | | | | | | | | | | | | | | | | | | |
| D | = | 1.85V | | | | | | | | | | | | | | | | | | | | | | | | | | | | | | | | | | | | | | | | | | | | | | | | | | | | | | | | | | | | | | | | | | | | | | |
| Y | = | 1.9V | | | | | | | | | | | | | | | | | | | | | | | | | | | | | | | | | | | | | | | | | | | | | | | | | | | | | | | | | | | | | | | | | | | | | | |
| H | = | 2.0V | | | | | | | | | | | | | | | | | | | | | | | | | | | | | | | | | | | | | | | | | | | | | | | | | | | | | | | | | | | | | | | | | | | | | | |
| E | = | 2.1V | | | | | | | | | | | | | | | | | | | | | | | | | | | | | | | | | | | | | | | | | | | | | | | | | | | | | | | | | | | | | | | | | | | | | | |
| J | = | 2.5V | | | | | | | | | | | | | | | | | | | | | | | | | | | | | | | | | | | | | | | | | | | | | | | | | | | | | | | | | | | | | | | | | | | | | | |
| K | = | 2.6V | | | | | | | | | | | | | | | | | | | | | | | | | | | | | | | | | | | | | | | | | | | | | | | | | | | | | | | | | | | | | | | | | | | | | | |
| I | = | 2.65V | | | | | | | | | | | | | | | | | | | | | | | | | | | | | | | | | | | | | | | | | | | | | | | | | | | | | | | | | | | | | | | | | | | | | | |
| L | = | 2.7V | | | | | | | | | | | | | | | | | | | | | | | | | | | | | | | | | | | | | | | | | | | | | | | | | | | | | | | | | | | | | | | | | | | | | | |
| M | = | 2.8V | | | | | | | | | | | | | | | | | | | | | | | | | | | | | | | | | | | | | | | | | | | | | | | | | | | | | | | | | | | | | | | | | | | | | | |
| N | = | 2.85V | | | | | | | | | | | | | | | | | | | | | | | | | | | | | | | | | | | | | | | | | | | | | | | | | | | | | | | | | | | | | | | | | | | | | | |
| O | = | 2.9V | | | | | | | | | | | | | | | | | | | | | | | | | | | | | | | | | | | | | | | | | | | | | | | | | | | | | | | | | | | | | | | | | | | | | | |
| P | = | 3.0V | | | | | | | | | | | | | | | | | | | | | | | | | | | | | | | | | | | | | | | | | | | | | | | | | | | | | | | | | | | | | | | | | | | | | | |
| Q | = | 3.1V | | | | | | | | | | | | | | | | | | | | | | | | | | | | | | | | | | | | | | | | | | | | | | | | | | | | | | | | | | | | | | | | | | | | | | |
| R | = | 3.2V | | | | | | | | | | | | | | | | | | | | | | | | | | | | | | | | | | | | | | | | | | | | | | | | | | | | | | | | | | | | | | | | | | | | | | |
| S | = | 3.3V | | | | | | | | | | | | | | | | | | | | | | | | | | | | | | | | | | | | | | | | | | | | | | | | | | | | | | | | | | | | | | | | | | | | | | |
| T | = | 3.4V | | | | | | | | | | | | | | | | | | | | | | | | | | | | | | | | | | | | | | | | | | | | | | | | | | | | | | | | | | | | | | | | | | | | | | |
| U | = | 3.5V | | | | | | | | | | | | | | | | | | | | | | | | | | | | | | | | | | | | | | | | | | | | | | | | | | | | | | | | | | | | | | | | | | | | | | |
| V | = | 3.6V | | | | | | | | | | | | | | | | | | | | | | | | | | | | | | | | | | | | | | | | | | | | | | | | | | | | | | | | | | | | | | | | | | | | | | |
| Junction Temperature Range: Y = -40°C to +125°C, RoHS-Compliant | | | | | | | | | | | | | | | | | | | | | | | | | | | | | | | | | | | | | | | | | | | | | | | | | | | | | | | | | | | | | | | | | | | | | | | | |
| Package: ML = 16-Lead 4 mm x 4 mm QFN | | | | | | | | | | | | | | | | | | | | | | | | | | | | | | | | | | | | | | | | | | | | | | | | | | | | | | | | | | | | | | | | | | | | | | | | |
| Media Type: TR = 5,000/Reel | | | | | | | | | | | | | | | | | | | | | | | | | | | | | | | | | | | | | | | | | | | | | | | | | | | | | | | | | | | | | | | | | | | | | | | | |
| Examples: | | | | | | | | | | | | | | | | | | | | | | | | | | | | | | | | | | | | | | | | | | | | | | | | | | | | | | | | | | | | | | | | | | | | | | | | |
| a) MIC2215-AAAYML-TR:MIC2215, Adjustable Output Voltages, -40°C to +125°C Temperature Range, 16-Lead QFN, 5,000/Reel | | | | | | | | | | | | | | | | | | | | | | | | | | | | | | | | | | | | | | | | | | | | | | | | | | | | | | | | | | | | | | | | | | | | | | | | |
| b) MIC2215-MMGYML-TR:MIC2215, 2.8V/2.8V/1.8V Output Voltages, -40°C to +125°C Temperature Range, 16-Lead QFN, 5,000/Reel | | | | | | | | | | | | | | | | | | | | | | | | | | | | | | | | | | | | | | | | | | | | | | | | | | | | | | | | | | | | | | | | | | | | | | | | |
| c) MIC2215-MMMYML-TR:MIC2215, 2.8V/2.8V/2.8V Output Voltages, -40°C to +125°C Temperature Range, 16-Lead QFN, 5,000/Reel | | | | | | | | | | | | | | | | | | | | | | | | | | | | | | | | | | | | | | | | | | | | | | | | | | | | | | | | | | | | | | | | | | | | | | | | |
| d) MIC2215-PMMYML-TR:MIC2215, 3.0V/2.8V/2.8V Output Voltages, -40°C to +125°C Temperature Range, 16-Lead QFN, 5,000/Reel | | | | | | | | | | | | | | | | | | | | | | | | | | | | | | | | | | | | | | | | | | | | | | | | | | | | | | | | | | | | | | | | | | | | | | | | |
| e) MIC2215-PPGYML-TR:MIC2215, 3.0V/3.0V/1.8V Output Voltages, -40°C to +125°C Temperature Range, 16-Lead QFN, 5,000/Reel | | | | | | | | | | | | | | | | | | | | | | | | | | | | | | | | | | | | | | | | | | | | | | | | | | | | | | | | | | | | | | | | | | | | | | | | |
| f) MIC2215-PPMYML-TR:MIC2215, 3.0V/3.0V/2.8V Output Voltages, -40°C to +125°C Temperature Range, 16-Lead QFN, 5,000/Reel | | | | | | | | | | | | | | | | | | | | | | | | | | | | | | | | | | | | | | | | | | | | | | | | | | | | | | | | | | | | | | | | | | | | | | | | |
| g) MIC2215-PPPYML-TR:MIC2215, 3.0V/3.0V/3.0V Output Voltages, -40°C to +125°C Temperature Range, 16-Lead QFN, 5,000/Reel | | | | | | | | | | | | | | | | | | | | | | | | | | | | | | | | | | | | | | | | | | | | | | | | | | | | | | | | | | | | | | | | | | | | | | | | |
| Note 1: Tape and Reel identifier only appears in the catalog part number description. This identifier is used for ordering purposes and is not printed on the device package. Check with your Microchip Sales Office for package availability with the Tape and Reel option. | | | | | | | | | | | | | | | | | | | | | | | | | | | | | | | | | | | | | | | | | | | | | | | | | | | | | | | | | | | | | | | | | | | | | | | | |

MIC2215

NOTES:

Note the following details of the code protection feature on Microchip products:

- Microchip products meet the specifications contained in their particular Microchip Data Sheet.
- Microchip believes that its family of products is secure when used in the intended manner, within operating specifications, and under normal conditions.
- Microchip values and aggressively protects its intellectual property rights. Attempts to breach the code protection features of Microchip product is strictly prohibited and may violate the Digital Millennium Copyright Act.
- Neither Microchip nor any other semiconductor manufacturer can guarantee the security of its code. Code protection does not mean that we are guaranteeing the product is “unbreakable”. Code protection is constantly evolving. Microchip is committed to continuously improving the code protection features of our products.

This publication and the information herein may be used only with Microchip products, including to design, test, and integrate Microchip products with your application. Use of this information in any other manner violates these terms. Information regarding device applications is provided only for your convenience and may be superseded by updates. It is your responsibility to ensure that your application meets with your specifications. Contact your local Microchip sales office for additional support or, obtain additional support at <https://www.microchip.com/en-us/support/design-help/client-support-services>.

THIS INFORMATION IS PROVIDED BY MICROCHIP "AS IS". MICROCHIP MAKES NO REPRESENTATIONS OR WARRANTIES OF ANY KIND WHETHER EXPRESS OR IMPLIED, WRITTEN OR ORAL, STATUTORY OR OTHERWISE, RELATED TO THE INFORMATION INCLUDING BUT NOT LIMITED TO ANY IMPLIED WARRANTIES OF NON-INFRINGEMENT, MERCHANTABILITY, AND FITNESS FOR A PARTICULAR PURPOSE, OR WARRANTIES RELATED TO ITS CONDITION, QUALITY, OR PERFORMANCE.

IN NO EVENT WILL MICROCHIP BE LIABLE FOR ANY INDIRECT, SPECIAL, PUNITIVE, INCIDENTAL, OR CONSEQUENTIAL LOSS, DAMAGE, COST, OR EXPENSE OF ANY KIND WHATSOEVER RELATED TO THE INFORMATION OR ITS USE, HOWEVER CAUSED, EVEN IF MICROCHIP HAS BEEN ADVISED OF THE POSSIBILITY OR THE DAMAGES ARE FORESEEABLE. TO THE FULLEST EXTENT ALLOWED BY LAW, MICROCHIP'S TOTAL LIABILITY ON ALL CLAIMS IN ANY WAY RELATED TO THE INFORMATION OR ITS USE WILL NOT EXCEED THE AMOUNT OF FEES, IF ANY, THAT YOU HAVE PAID DIRECTLY TO MICROCHIP FOR THE INFORMATION.

Use of Microchip devices in life support and/or safety applications is entirely at the buyer's risk, and the buyer agrees to defend, indemnify and hold harmless Microchip from any and all damages, claims, suits, or expenses resulting from such use. No licenses are conveyed, implicitly or otherwise, under any Microchip intellectual property rights unless otherwise stated.

For information regarding Microchip's Quality Management Systems, please visit www.microchip.com/quality.

Trademarks

The Microchip name and logo, the Microchip logo, Adaptec, AnyRate, AVR, AVR logo, AVR Freaks, BesTime, BitCloud, CryptoMemory, CryptoRF, dsPIC, flexPWR, HELDO, IGLOO, JukeBlox, KeeLoq, Kleer, LANCheck, LinkMD, maXStylus, maXTouch, MediaLB, megaAVR, Microsemi, Microsemi logo, MOST, MOST logo, MPLAB, OptoLyzr, PIC, picoPower, PICSTART, PIC32 logo, PolarFire, Prochip Designer, QTouch, SAM-BA, SenGenuity, SpyNIC, SST, SST Logo, SuperFlash, Symmetricom, SyncServer, Tachyon, TimeSource, tinyAVR, UNI/O, Vectron, and XMEGA are registered trademarks of Microchip Technology Incorporated in the U.S.A. and other countries.

AgileSwitch, APT, ClockWorks, The Embedded Control Solutions Company, EtherSynch, Flashtec, Hyper Speed Control, HyperLight Load, IntelliMOS, Libero, motorBench, mTouch, Powermite 3, Precision Edge, ProASIC, ProASIC Plus, ProASIC Plus logo, QuietWire, SmartFusion, SyncWorld, Temux, TimeCesium, TimeHub, TimePictra, TimeProvider, TrueTime, WinPath, and ZL are registered trademarks of Microchip Technology Incorporated in the U.S.A.

Adjacent Key Suppression, AKS, Analog-for-the-Digital Age, Any Capacitor, AnyIn, AnyOut, Augmented Switching, BlueSky, BodyCom, CodeGuard, CryptoAuthentication, CryptoAutomotive, CryptoCompanion, CryptoController, dsPICDEM, dsPICDEM.net, Dynamic Average Matching, DAM, ECAN, Espresso T1S, EtherGREEN, GridTime, IdealBridge, In-Circuit Serial Programming, ICSP, INICnet, Intelligent Paralleling, Inter-Chip Connectivity, JitterBlocker, Knob-on-Display, maxCrypto, maxView, memBrain, Mindi, MiWi, MPASM, MPF, MPLAB Certified logo, MPLIB, MPLINK, MultiTRAK, NetDetach, NVM Express, NVMe, Omniscient Code Generation, PICDEM, PICDEM.net, PICkit, PICtail, PowerSmart, PureSilicon, QMatrix, REAL ICE, Ripple Blocker, RTAX, RTG4, SAM-ICE, Serial Quad I/O, simpleMAP, SimpliPHY, SmartBuffer, SmartHLS, SMART-I.S., storClad, SQL, SuperSwitcher, SuperSwitcher II, Switchtec, SynchroPHY, Total Endurance, TSHARC, USBCheck, VariSense, VectorBlox, VeriPHY, ViewSpan, WiperLock, XpressConnect, and ZENA are trademarks of Microchip Technology Incorporated in the U.S.A. and other countries.

SQTP is a service mark of Microchip Technology Incorporated in the U.S.A.

The Adaptec logo, Frequency on Demand, Silicon Storage Technology, Symmcom, and Trusted Time are registered trademarks of Microchip Technology Inc. in other countries.

GestIC is a registered trademark of Microchip Technology Germany II GmbH & Co. KG, a subsidiary of Microchip Technology Inc., in other countries.

All other trademarks mentioned herein are property of their respective companies.

© 2019 - 2022, Microchip Technology Incorporated and its subsidiaries.

All Rights Reserved.

ISBN: 978-1-6683-0062-6



MICROCHIP

Worldwide Sales and Service

AMERICAS

Corporate Office
2355 West Chandler Blvd.
Chandler, AZ 85224-6199
Tel: 480-792-7200
Fax: 480-792-7277
Technical Support:
<http://www.microchip.com/support>
Web Address:
www.microchip.com

Atlanta

Duluth, GA
Tel: 678-957-9614
Fax: 678-957-1455

Austin, TX

Tel: 512-257-3370

Boston

Westborough, MA
Tel: 774-760-0087
Fax: 774-760-0088

Chicago

Itasca, IL
Tel: 630-285-0071
Fax: 630-285-0075

Dallas

Addison, TX
Tel: 972-818-7423
Fax: 972-818-2924

Detroit

Novi, MI
Tel: 248-848-4000

Houston, TX

Tel: 281-894-5983

Indianapolis

Noblesville, IN
Tel: 317-773-8323
Fax: 317-773-5453
Tel: 317-536-2380

Los Angeles

Mission Viejo, CA
Tel: 949-462-9523
Fax: 949-462-9608
Tel: 951-273-7800

Raleigh, NC

Tel: 919-844-7510

New York, NY

Tel: 631-435-6000

San Jose, CA

Tel: 408-735-9110
Tel: 408-436-4270

Canada - Toronto

Tel: 905-695-1980
Fax: 905-695-2078

ASIA/PACIFIC

Australia - Sydney
Tel: 61-2-9868-6733

China - Beijing
Tel: 86-10-8569-7000

China - Chengdu
Tel: 86-28-8665-5511

China - Chongqing
Tel: 86-23-8980-9588

China - Dongguan
Tel: 86-769-8702-9880

China - Guangzhou
Tel: 86-20-8755-8029

China - Hangzhou
Tel: 86-571-8792-8115

China - Hong Kong SAR
Tel: 852-2943-5100

China - Nanjing
Tel: 86-25-8473-2460

China - Qingdao
Tel: 86-532-8502-7355

China - Shanghai
Tel: 86-21-3326-8000

China - Shenyang
Tel: 86-24-2334-2829

China - Shenzhen
Tel: 86-755-8864-2200

China - Suzhou
Tel: 86-186-6233-1526

China - Wuhan
Tel: 86-27-5980-5300

China - Xian
Tel: 86-29-8833-7252

China - Xiamen
Tel: 86-592-2388138

China - Zhuhai
Tel: 86-756-3210040

ASIA/PACIFIC

India - Bangalore
Tel: 91-80-3090-4444

India - New Delhi
Tel: 91-11-4160-8631

India - Pune
Tel: 91-20-4121-0141

Japan - Osaka
Tel: 81-6-6152-7160

Japan - Tokyo
Tel: 81-3-6880-3770

Korea - Daegu
Tel: 82-53-744-4301

Korea - Seoul
Tel: 82-2-554-7200

Malaysia - Kuala Lumpur
Tel: 60-3-7651-7906

Malaysia - Penang
Tel: 60-4-227-8870

Philippines - Manila
Tel: 63-2-634-9065

Singapore
Tel: 65-6334-8870

Taiwan - Hsin Chu
Tel: 886-3-577-8366

Taiwan - Kaohsiung
Tel: 886-7-213-7830

Taiwan - Taipei
Tel: 886-2-2508-8600

Thailand - Bangkok
Tel: 66-2-694-1351

Vietnam - Ho Chi Minh
Tel: 84-28-5448-2100

EUROPE

Austria - Wels
Tel: 43-7242-2244-39
Fax: 43-7242-2244-393

Denmark - Copenhagen
Tel: 45-4485-5910
Fax: 45-4485-2829

Finland - Espoo
Tel: 358-9-4520-820

France - Paris
Tel: 33-1-69-53-63-20
Fax: 33-1-69-30-90-79

Germany - Garching
Tel: 49-8931-9700

Germany - Haan
Tel: 49-2129-3766400

Germany - Heilbronn
Tel: 49-7131-72400

Germany - Karlsruhe
Tel: 49-721-625370

Germany - Munich
Tel: 49-89-627-144-0
Fax: 49-89-627-144-44

Germany - Rosenheim
Tel: 49-8031-354-560

Israel - Ra'anana
Tel: 972-9-744-7705

Italy - Milan
Tel: 39-0331-742611
Fax: 39-0331-466781

Italy - Padova
Tel: 39-049-7625286

Netherlands - Drunen
Tel: 31-416-690399
Fax: 31-416-690340

Norway - Trondheim
Tel: 47-7288-4388

Poland - Warsaw
Tel: 48-22-3325737

Romania - Bucharest
Tel: 40-21-407-87-50

Spain - Madrid
Tel: 34-91-708-08-90
Fax: 34-91-708-08-91

Sweden - Gothenberg
Tel: 46-31-704-60-40

Sweden - Stockholm
Tel: 46-8-5090-4654

UK - Wokingham
Tel: 44-118-921-5800
Fax: 44-118-921-5820