

3 Volt Voltage Variable Absorptive Attenuator 40 dB, 0.5 - 2.0 GHz

Rev. V1

Features

- Single Positive Voltage Control: 0 to +3 Volts
- 40 dB Attenuation Range at 0.9 GHz
- ± 2 dB Linearity from BSL
- Low DC Power Consumption
- Lead-Free SOIC-8 Plastic Package
- 100% Matte Tin Plating over Copper
- Halogen-Free “Green” Mold Compound
- 260°C Reflow Compatible
- RoHS* Compliant Version of AT-113

Description

M/A-COM’s MAAV-008022 is a GaAs MMIC voltage variable absorptive attenuator in a lead-free low-cost SOIC 8-lead surface mount plastic package. The MAAV-008022 is ideally suited for use where linear attenuation fine tuning and very low power consumption are required.

Typical applications include radio, cellular, GPS equipment and automatic gain/level control circuits.

The MAAV-008022 is fabricated with a monolithic GaAs MMIC using a mature 1-micron process. The process features full chip passivation for increased performance and reliability.

Ordering Information ¹

Part Number	Package
MAAV-008022-000000	Bulk Packaging
MAAV-008022-TR3000	3000 piece reel

1. Reference Application Note M513 for reel size information.

Functional Schematic ^{2,3,4,5}

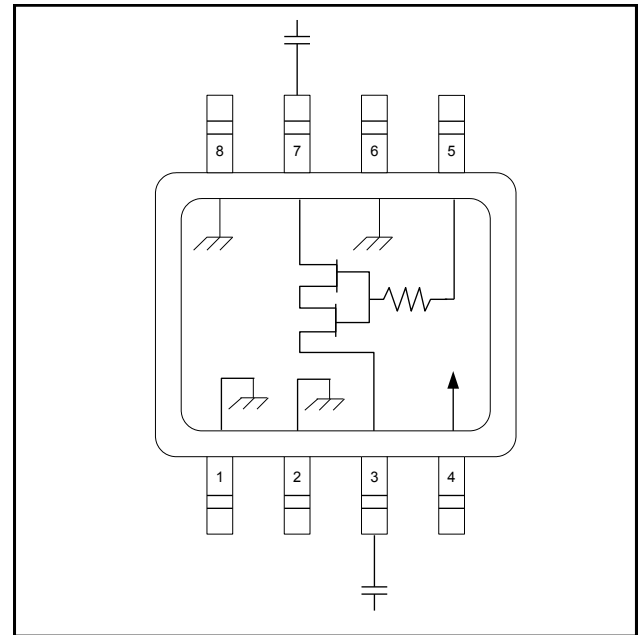

2. $V_{CC} = +3$ VDC @ 50 μ A maximum.
3. $V_C = 0$ VDC to +3 VDC @ 50 μ A maximum.
4. External DC blocking capacitors are required on all RF ports.
5. 39 pF used for data measurements.

Pin Configuration

Pin No.	Function	Pin No.	Function
1	Ground	5	V_C
2	Ground	6	Ground
3	RF Port	7	RF Port
4	V_{CC}	8	Ground

Absolute Maximum Ratings ⁶

Parameter	Absolute Maximum
Input Power	+21 dBm
Supply Voltage V_{CC}	$-1 \text{ V} \leq V_{CC} \leq +8 \text{ V}$
Control Voltage V_C	$-1 \text{ V} \leq V_C \leq V_{CC} + 0.5 \text{ V}$
Operating Temperature	-40°C to $+85^\circ\text{C}$
Storage Temperature	-65°C to $+150^\circ\text{C}$

6. Exceeding any one or combination of these limits may cause permanent damage to this device.

* Restrictions on Hazardous Substances, European Directive 2002/95/EC.

3 Volt Voltage Variable Absorptive Attenuator 40 dB, 0.5 - 2.0 GHz

Rev. V1

Electrical Specifications ⁷: $T_A = 25^\circ\text{C}$, $Z_0 = 50 \Omega$

Parameter	Test Conditions	Units	Min	Typ	Max
Insertion Loss	0.5 - 1.0 GHz	dB	—	2.7	3.0
	1.0 - 2.0 GHz	dB	—	3.0	3.5
Attenuation (Relative to Insertion Loss)	Frequency = 0.5 - 2.0 GHz	dB	34	35	—
	$V_c = 0.0 \text{ V}$ (max. atten.)	dB	26	30	—
	$V_c = 1.5 \text{ V}$	dB	12.5	15	17.5
	$V_c = 2.7 \text{ V}$	dB	—	.5	0.7
Slope (at any point on the curve)	$V_c \text{ delta } 0.5 \text{ V} - 1.5 \text{ V}$	dB/V	10	15	23
	$V_c \text{ delta } 1.5 \text{ V} - 2.7 \text{ V}$	dB/V	0	14	17
VSWR	—	Ratio	—	2:1	—
Trise, Tfall	10% to 90% RF, 90% to 10% RF	μS	—	10	—
Ton, Toff	50% Control to 90% RF, 50% Control to 10% RF	μS	—	12	—
Transients	In-band	mV	—	10	—

7. The RF ports must be blocked outside of the package from ground or any other voltage.

Lead-Free SOIC-8[†]

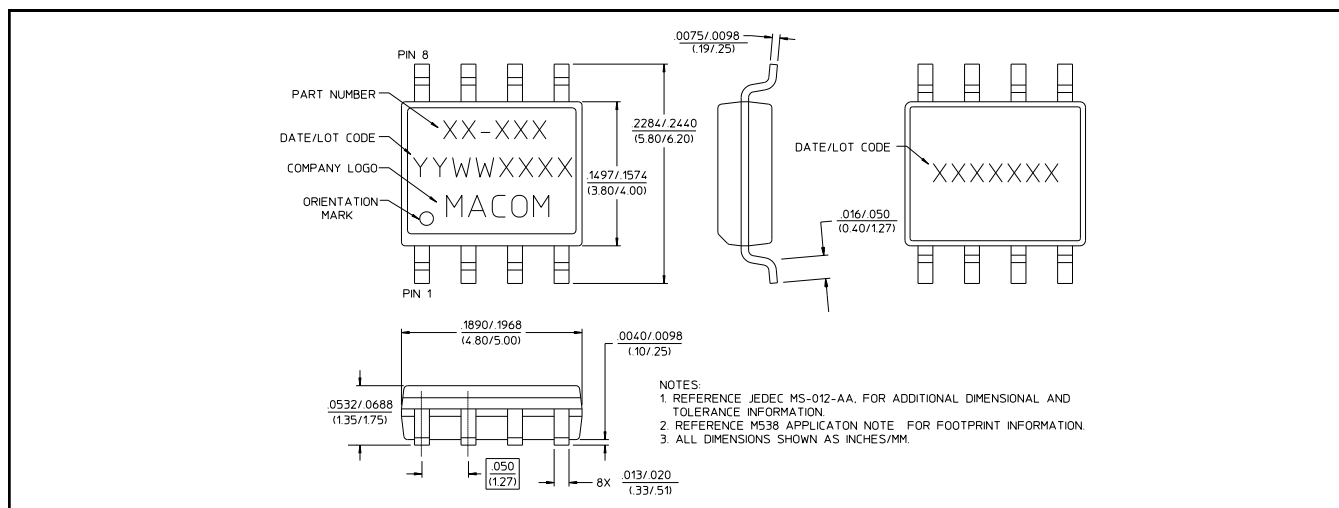

[†] Reference Application Note M538 for lead-free solder reflow recommendations.
Meets JEDEC moisture sensitivity level 1 requirements.

3 Volt Voltage Variable Absorptive Attenuator 40 dB, 0.5 - 2.0 GHz

Rev. V1

Typical Performance Curves @ 25°C

Attenuation vs. Control Voltage

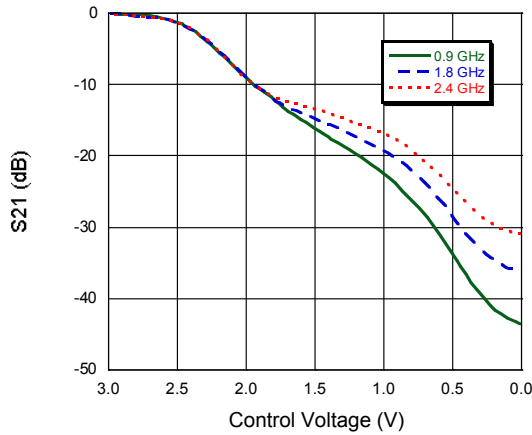

Attenuation vs. Frequency @ 0V

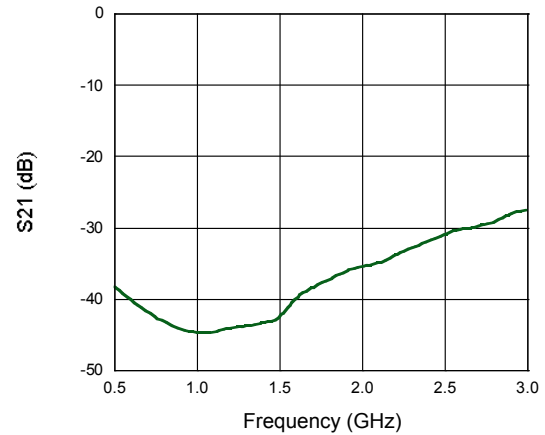

Insertion Loss vs. Frequency

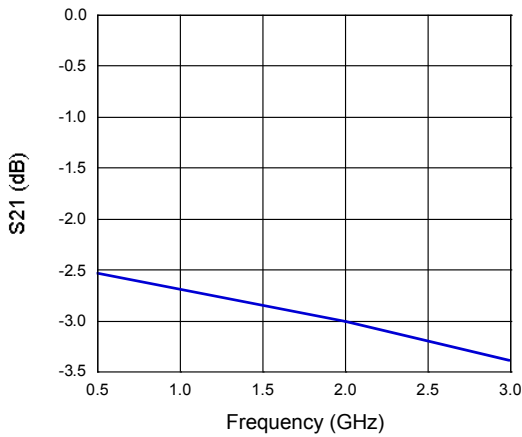

Return Loss vs. Control Voltage, F = 900 MHz

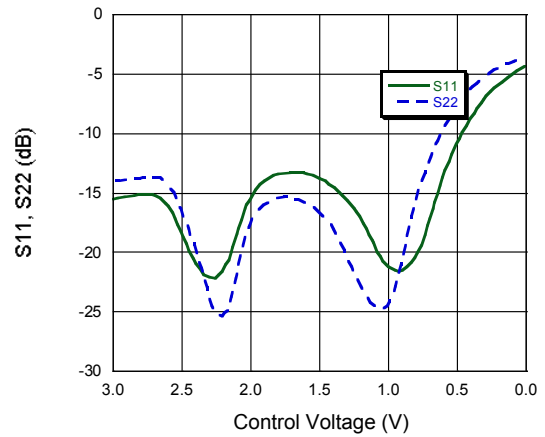

1 dB Compression vs. Control Voltage

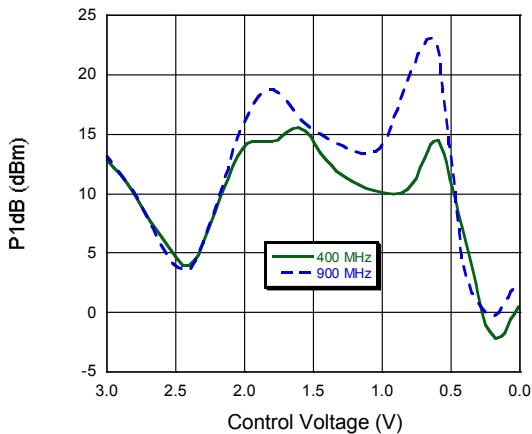

IP3 vs. Control Voltage

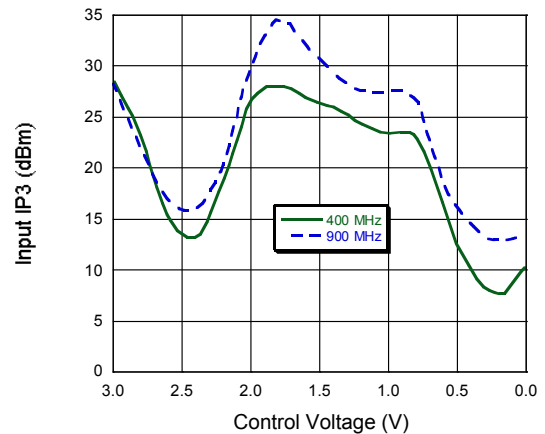

3 Volt Voltage Variable Absorptive Attenuator 40 dB, 0.5 - 2.0 GHz

Rev. V1

Typical Performance Curves @ 25°C

Attenuation vs. Temperature
Normalized @ 25°C, F = 900 MHz

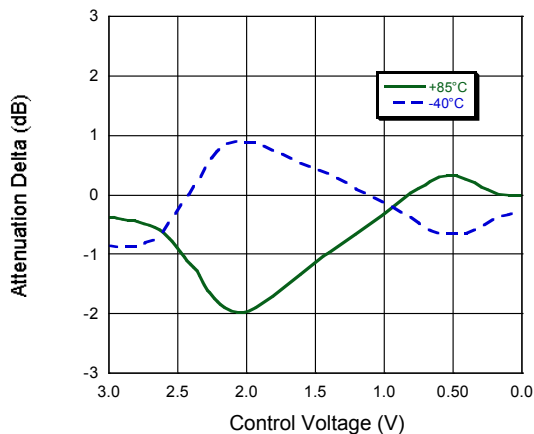

Handling Procedures

Please observe the following precautions to avoid damage:

Static Sensitivity

Gallium Arsenide Integrated Circuits are sensitive to electrostatic discharge (ESD) and can be damaged by static electricity. Proper ESD control techniques should be used when handling these devices.

M/A-COM Technology Solutions Inc. All rights reserved.

Information in this document is provided in connection with M/A-COM Technology Solutions Inc ("MACOM") products. These materials are provided by MACOM as a service to its customers and may be used for informational purposes only. Except as provided in MACOM's Terms and Conditions of Sale for such products or in any separate agreement related to this document, MACOM assumes no liability whatsoever. MACOM assumes no responsibility for errors or omissions in these materials. MACOM may make changes to specifications and product descriptions at any time, without notice. MACOM makes no commitment to update the information and shall have no responsibility whatsoever for conflicts or incompatibilities arising from future changes to its specifications and product descriptions. No license, express or implied, by estoppel or otherwise, to any intellectual property rights is granted by this document.

THESE MATERIALS ARE PROVIDED "AS IS" WITHOUT WARRANTY OF ANY KIND, EITHER EXPRESS OR IMPLIED, RELATING TO SALE AND/OR USE OF MACOM PRODUCTS INCLUDING LIABILITY OR WARRANTIES RELATING TO FITNESS FOR A PARTICULAR PURPOSE, CONSEQUENTIAL OR INCIDENTAL DAMAGES, MERCHANTABILITY, OR INFRINGEMENT OF ANY PATENT, COPYRIGHT OR OTHER INTELLECTUAL PROPERTY RIGHT. MACOM FURTHER DOES NOT WARRANT THE ACCURACY OR COMPLETENESS OF THE INFORMATION, TEXT, GRAPHICS OR OTHER ITEMS CONTAINED WITHIN THESE MATERIALS. MACOM SHALL NOT BE LIABLE FOR ANY SPECIAL, INDIRECT, INCIDENTAL, OR CONSEQUENTIAL DAMAGES, INCLUDING WITHOUT LIMITATION, LOST REVENUES OR LOST PROFITS, WHICH MAY RESULT FROM THE USE OF THESE MATERIALS.

MACOM products are not intended for use in medical, lifesaving or life sustaining applications. MACOM customers using or selling MACOM products for use in such applications do so at their own risk and agree to fully indemnify MACOM for any damages resulting from such improper use or sale.