

OMNIMATE Power - series LL LLFS 7.50/04/180V 5.0SN BK BX

Weidmüller Interface GmbH & Co. KG
Klingenbergstraße 16
D-32758 Detmold
Germany
Fon: +49 5231 14-0
Fax: +49 5231 14-292083
www.weidmueller.com

Product image

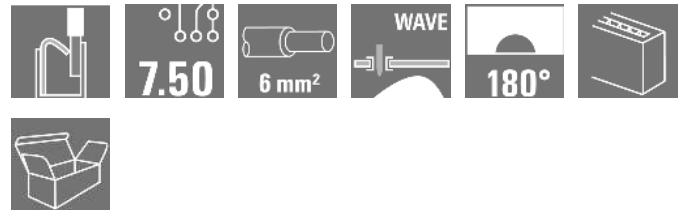

The sturdy, direct connection for extreme current and voltage requirements in all power electronics applications such as solar inverters, frequency converters, servo-controllers and power supplies.

General ordering data

Type	LLFS 7.50/04/180V 5.0SN BK BX
Order No.	2491640000
Version	Printed circuit board terminals, 7.50 mm, No. of poles: 4, 180°, Solder pin length (l): 5 mm, tinned, black, PUSH IN without actuator, Clamping range, max.: 6 mm², Box
GTIN (EAN)	4050118579437
Qty.	80 pc(s).
Product data	IEC: 1000 V / 41 A / 0.5 - 6 mm² UL: 600 V / 37 A / AWG 24 - AWG 8
Packaging	Box

**OMNIMATE Power - series LL
LLFS 7.50/04/180V 5.0SN BK BX**

Weidmüller Interface GmbH & Co. KG
 Klingenbergstraße 16
 D-32758 Detmold
 Germany
 Fon: +49 5231 14-0
 Fax: +49 5231 14-292083
 www.weidmueller.com

Technical data**Dimensions and weights**

Width	31.8 mm	Width (inches)	1.252 inch
Height	29.15 mm	Height (inches)	1.148 inch
Height of lowest version	24.15 mm	Depth	18.5 mm
Depth (inches)	0.728 inch	Net weight	14.71 g

System parameters

Product family	OMNIMATE Power - series LL	Wire connection method	PUSH IN without actuator
Mounting onto the PCB	THT solder connection	Conductor outlet direction	180°
Pitch in mm (P)	7.5 mm	Pitch in inches (P)	0.295 inch
No. of poles	4	Fitted by customer	No
Solder pin length (l)	5 mm	Solder pin dimensions	d = 1.5 mm
Solder eyelet hole diameter (D)	2 mm	Solder eyelet hole diameter tolerance (D)+	0,1 mm
Number of solder pins per pole	1	Stripping length	12 mm
L1 in mm	22.5 mm	L1 in inches	0.886 inch
Touch-safe protection acc. to DIN VDE 0470	IP 20	Touch-safe protection acc. to DIN VDE 57 106	Safe from finger touch

Material data

Insulating material	Wemid (PA)	Colour	black
Colour chart (similar)	RAL 9011	Insulating material group	I
Insulation strength	$\geq 10^8 \Omega$	UL 94 flammability rating	V-0
Contact material	E-Cu	Contact surface	tinned
Layer structure of solder connection	4-10 μ Sn matt	Storage temperature, min.	-40 °C
Storage temperature, max.	85 °C	Max. relative humidity during storage	80 %
Operating temperature, min.	-40 °C	Operating temperature, max.	120 °C

Conductors suitable for connection

Clamping range, min.	0.25 mm ²
Clamping range, max.	6 mm ²
Wire connection cross section AWG, min.	AWG 24
Wire connection cross section AWG, max.	AWG 8
Solid, min. H05(07) V-U	0.5 mm ²
Solid, max. H05(07) V-U	6 mm ²
Flexible, min. H05(07) V-K	0.5 mm ²
Flexible, max. H05(07) V-K	6 mm ²
w. plastic collar ferrule, DIN 46228 pt 4, 0.25 mm ² min.	
w. plastic collar ferrule, DIN 46228 pt 4, 6 mm ² max.	
w. wire end ferrule, DIN 46228 pt 1, min 0.25 mm ²	
w. wire end ferrule, DIN 46228 pt 1, 6 mm ² max.	

OMNIMATE Power - series LL
LLFS 7.50/04/180V 5.0SN BK BX

Weidmüller Interface GmbH & Co. KG
 Klingenbergstraße 16
 D-32758 Detmold
 Germany
 Fon: +49 5231 14-0
 Fax: +49 5231 14-292083
 www.weidmueller.com

Technical data

Clampable conductor	Cross-section for conductor connection	Type	fine-wired
		nominal	0.5 mm ²
wire end ferrule		Stripping length	nominal 14 mm
		Recommended wire-end ferrule	1076980000
Cross-section for conductor connection	Type	fine-wired	
	nominal	1 mm ²	
wire end ferrule		Stripping length	nominal 15 mm
		Recommended wire-end ferrule	9025930000
Cross-section for conductor connection	Type	fine-wired	
	nominal	1.5 mm ²	
wire end ferrule		Stripping length	nominal 15 mm
		Recommended wire-end ferrule	9019140000
		Stripping length	nominal 12 mm
		Recommended wire-end ferrule	9004060000
Cross-section for conductor connection	Type	fine-wired	
	nominal	0.75 mm ²	
wire end ferrule		Stripping length	nominal 14 mm
		Recommended wire-end ferrule	9025910000
Cross-section for conductor connection	Type	fine-wired	
	nominal	2.5 mm ²	
wire end ferrule		Stripping length	nominal 14 mm
		Recommended wire-end ferrule	9019170000
		Stripping length	nominal 12 mm
		Recommended wire-end ferrule	0186100000
Cross-section for conductor connection	Type	fine-wired	
	nominal	4 mm ²	
wire end ferrule		Stripping length	nominal 12 mm
		Recommended wire-end ferrule	0244100000
		Stripping length	nominal 14 mm
		Recommended wire-end ferrule	9019200000
Cross-section for conductor connection	Type	fine-wired	
	nominal	6 mm ²	
wire end ferrule		Stripping length	nominal 14 mm
		Recommended wire-end ferrule	0533500000
		Stripping length	nominal 12 mm
		Recommended wire-end ferrule	0191900000
Cross-section for conductor connection	Type	fine-wired	
	nominal	10 mm ²	
wire end ferrule		Stripping length	nominal 12 mm
		Recommended wire-end ferrule	0282900000
Max. clamping range	6 mm ²		

**OMNIMATE Power - series LL
LLFS 7.50/04/180V 5.0SN BK BX**

Weidmüller Interface GmbH & Co. KG
Klingenbergstraße 16
D-32758 Detmold
Germany
Fon: +49 5231 14-0
Fax: +49 5231 14-292083
www.weidmueller.com

Technical data

Rated data acc. to IEC

tested acc. to standard	In accordance with IEC 60947-7-1	Rated current, min. no. of poles (Tu=20°C)	41 A
Rated current, max. no. of poles (Tu=20°C)	32 A	Rated current, min. no. of poles (Tu=40°C)	38 A
Rated current, max. no. of poles (Tu=40°C)	28 A	Rated voltage for surge voltage class / pollution degree II/2	1,000 V
Rated voltage for surge voltage class / pollution degree III/2	1,000 V	Rated voltage for surge voltage class / pollution degree III/3	1,000 V
Rated impulse voltage for surge voltage class/ pollution degree II/2	8 kV	Rated impulse voltage for surge voltage class/ pollution degree III/2	8 kV
Rated impulse voltage for surge voltage class/ contamination degree III/3	8 kV		

Rated data acc. to CSA

Rated voltage (Use group B / CSA)	600 V	Rated voltage (Use group C / CSA)	600 V
Rated voltage (Use group D / CSA)	600 V	Rated current (Use group B / CSA)	37 A
Rated current (Use group C / CSA)	37 A	Rated current (Use group D / CSA)	5 A

Rated data acc. to UL 1059

Institute (cURus)		Certificate No. (cURus)	E60693
Rated voltage (Use group B / UL 1059)	600 V	Rated voltage (Use group C / UL 1059)	600 V
Rated voltage (Use group D / UL 1059)	600 V	Rated current (Use group B / UL 1059)	37 A
Rated current (Use group C / UL 1059)	37 A	Rated current (Use group D / UL 1059)	5 A
Wire cross-section, AWG, min.	AWG 24	Wire cross-section, AWG, max.	AWG 8
Reference to approval values	Specifications are maximum values, details - see approval certificate.		

Packing

Packaging	Box	VPE length	0 m
VPE width	0 m	VPE height	0 m

Classifications

ETIM 3.0	EC001284	ETIM 4.0	EC002643
ETIM 5.0	EC002643	ETIM 6.0	EC002643
eClass 6.2	27-26-11-01	eClass 9.0	27-44-04-01
eClass 9.1	27-44-04-01		

Data sheet

**OMNIMATE Power - series LL
LLFS 7.50/04/180V 5.0SN BK BX**

Weidmüller Interface GmbH & Co. KG
Klingenbergstraße 16
D-32758 Detmold
Germany
Fon: +49 5231 14-0
Fax: +49 5231 14-292083
www.weidmueller.com

Technical data

Notes

- | | |
|-------|--|
| Notes | <ul style="list-style-type: none"> • Additional colours on request
 • Rated current related to rated cross-section & min. No. of poles.
 • Wire end ferrule without plastic collar to DIN 46228/1
 • Wire end ferrule with plastic collar to DIN 46228/4
 • P on drawing = pitch
 • Rated data refer only to the component itself. Clearance and creepage distances to other components are to be designed in accordance with the relevant application standards.
 • The test point can only be used as potential-pickup point. |
|-------|--|

IPC conformity	Conformity: The products are developed, manufactured and delivered according international recognized standards and norms and comply with the assured properties in the data sheet resp. fulfill decorative properties in accordance with IPC-A-610 "Class 2". Further claims on the products can be evaluated on request.
----------------	--

Approvals

Approvals



Downloads

Approval/Certificate/Document of Conformity	Declaration of the Manufacturer
Engineering Data	STEP
Motion controllers white paper	Download Whitepaper
White Paper UL 600 V	Download Whitepaper

OMNIMATE Power - series LL
LLFS 7.50/04/180V 5.0SN BK BX

Weidmüller Interface GmbH & Co. KG
 Klingenbergstraße 16
 D-32758 Detmold
 Germany
 Fon: +49 5231 14-0
 Fax: +49 5231 14-292083
 www.weidmueller.com

Drawings

Dimensional drawing

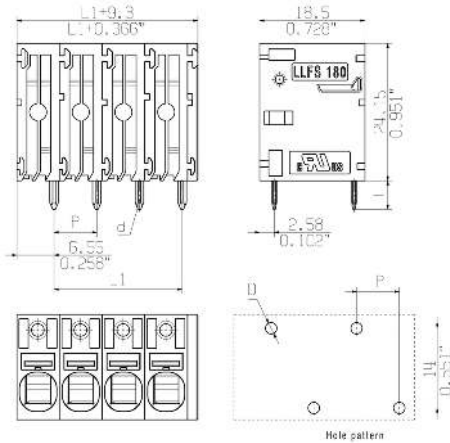

Derating curve

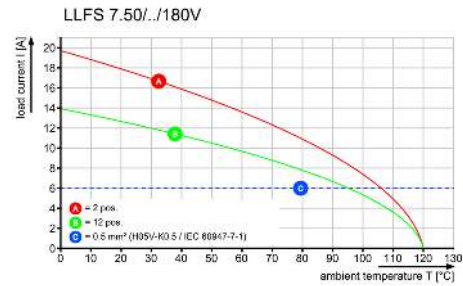

Derating curve

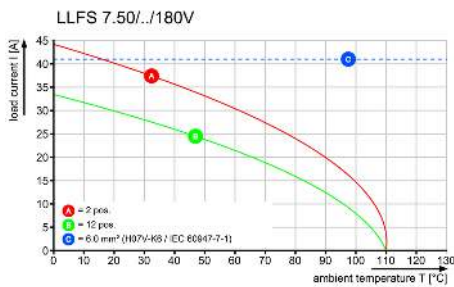

Product benefits

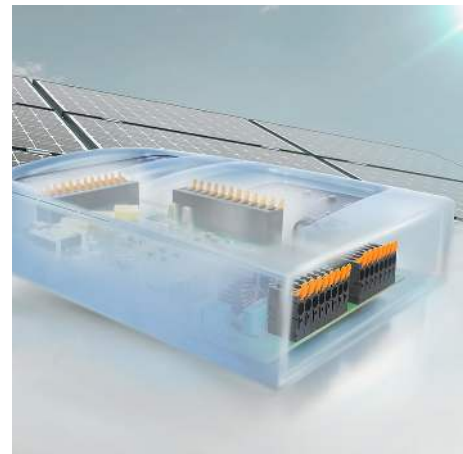

Power up to UL 600 V
 Offset solder pins

Product benefits



Tool-free wiring
 Top contact security

04

General customer drawing, topical version only if required

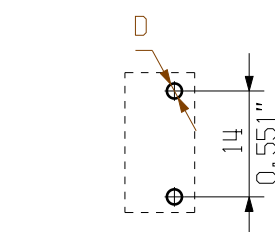
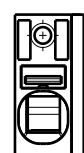
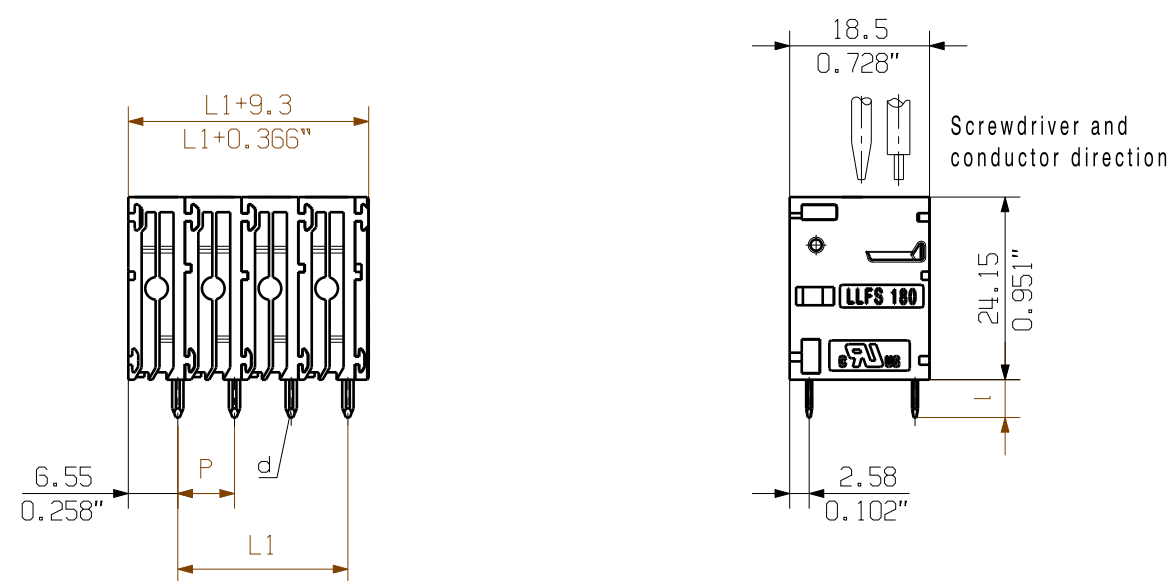
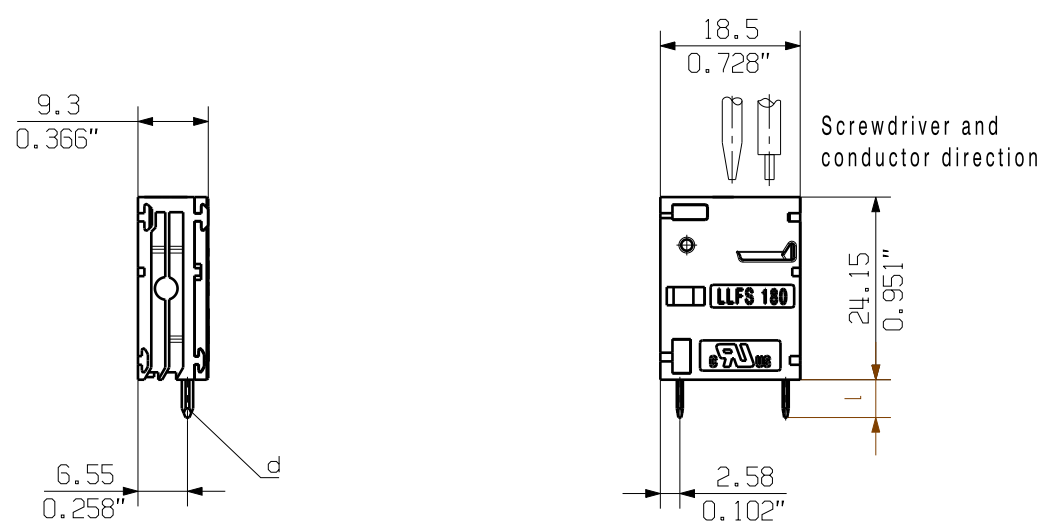

Hole pattern

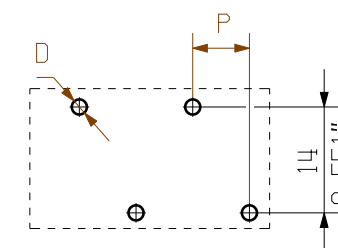
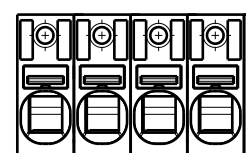

Hole pattern

12	82.50	3.248
11	75.00	2.953
10	67.50	2.657
9	60.00	2.362
8	52.50	2.067
7	45.00	1.772
6	37.50	1.476
5	30.00	1.181
4	22.50	0.886
3	15.00	0.591
2	7.50	0.295
n Poles	L1 [mm]	L1 [inch]

P = 7.50
0.295" (Pitch)
D = Ø2 +0.1
0.079"
d = 1.5x0.8
0.059"x0.031"
l = 5.0 +0.2 -0.6
0.197"

For the mounting of PCBs, it should be noted that the rated data relates only to the PCB components alone.
The necessary creepage and clearance paths must be observed in connection with the respective applicant in accordance to IEC 664 / VDE 0110.
The current-carrying capacity and pitch tolerance is to be determined according to DIN IEC 326 part 3 very fine.

Weidmüller PCB components are tested to the DIN EN 61984 standard, and are valid for its field of application. Provided that the components are used to the intended purpose, all requirements with respect to the occurring of electrical, mechanical, thermic and corrosive stress will be satisfied.

General tolerance: DIN ISO 2768-mK		95864/4 14.07.17 XIANG_K		01	Cat.no.: .	
		Modification				3 64139 04 Drawing no. Issue no.
		Drawn	Date	Name	Sheet 01 of 01 sheets	
Scale: 1/1	Responsible	22.09.2016	HILDEBRANDT_R	LLFS 7.50/.../180 ... LEITERPLATTENKLEMME PCB TERMINAL		Product file: LLF 7.50 7416
Supersedes: .	Checked	14.07.2017	ZHOU_N			
		Approved	NOLTE_S			

The reproduction, distribution and utilization of this document as well as the communication of its contents to others without explicit authorization is prohibited. Offenders will be held liable for the payment of damages. Weidmüller exclusively reserves the right to file for patents, utility models or designs.

© Weidmüller Interface GmbH & Co. KG

Recommended wave soldering profiles

Weidmüller Interface GmbH & Co. KG
 Klängenbergstraße 16
 D-32758 Detmold
 Germany
 Fon: +49 5231 14-0
 Fax: +49 5231 14-292083
 www.weidmueller.com

Single Wave:

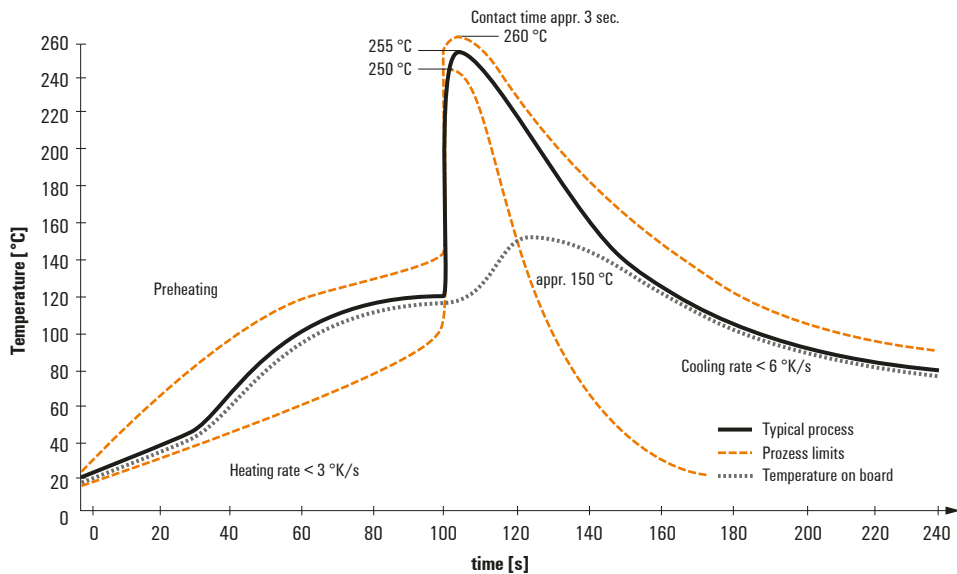

Double Wave:

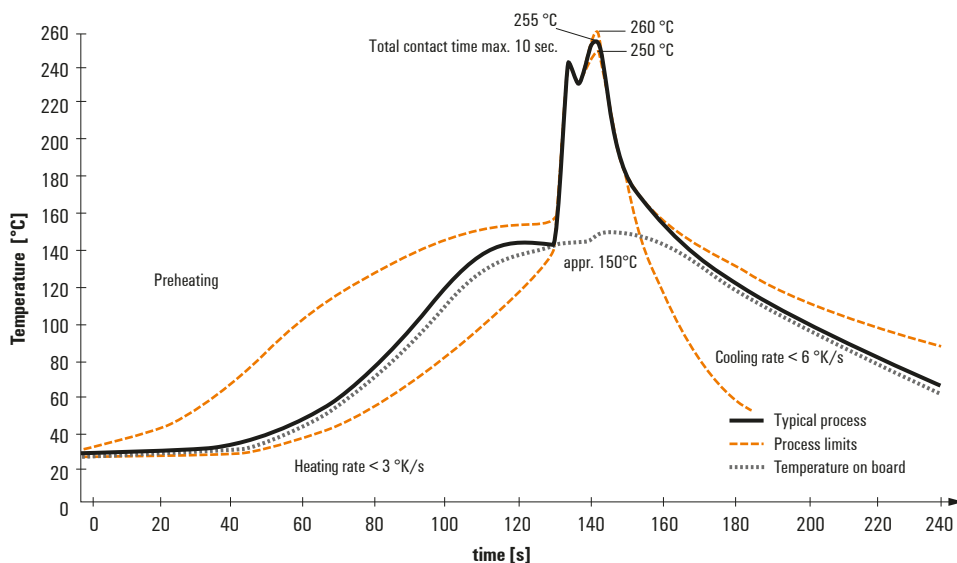

Wave soldering profiles

Wired connection elements should be processed in accordance with the DIN EN 61760-1 standard. We have included two recommendations for practical wave soldering profiles, with which Weidmüller PCB terminals and connectors are qualified.

When choosing a suitable profile for your application, the following factors also need to be considered:

- PCB thickness
- Proportion of Cu in the layers
- Single/double-sided assembly
- Product range
- Heating and cooling rates

The single and double wave profiles each indicate the recommended operating range, including the maximum soldering temperature of 260°C. In practice, the maximum soldering temperature is quite often well below the above maximum profile.