

# NSI45060DDT4G

## Adjustable Constant Current Regulator & LED Driver

45 V, 60 – 100 mA ± 15%, 2.7 W Package

The adjustable constant current regulator (CCR) is a simple, economical and robust device designed to provide a cost effective solution for regulating current in LEDs. The CCR is based on patent-pending Self-Biased Transistor (SBT) technology and regulates current over a wide voltage range. It is designed with a negative temperature coefficient to protect LEDs from thermal runaway at extreme voltages and currents.

The CCR turns on immediately and is at 20% of regulation with only 0.5 V  $V_{ak}$ . The  $R_{adj}$  pin allows  $I_{reg(SS)}$  to be adjusted to higher currents by attaching a resistor between  $R_{adj}$  (Pin 3) and the Cathode (Pin 4). The  $R_{adj}$  pin can also be left open (No Connect) if no adjustment is required. It requires no external components allowing it to be designed as a high or low-side regulator. The high anode-cathode voltage rating withstands surges common in Automotive, Industrial and Commercial Signage applications. This device is available in a thermally robust package, which is lead-free RoHS compliant and uses halogen-free molding compound. For the AEC-Q101 part please see the NSI45060JD datasheet.

### Features

- Robust Power Package: 2.7 Watts
- Adjustable up to 100 mA
- Wide Operating Voltage Range
- Immediate Turn-On
- Voltage Surge Suppressing – Protecting LEDs
- SBT (Self-Biased Transistor) Technology
- Negative Temperature Coefficient
- Eliminates Additional Regulation
- These Devices are Pb-Free, Halogen Free/BFR Free and are RoHS Compliant

### Applications

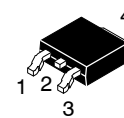
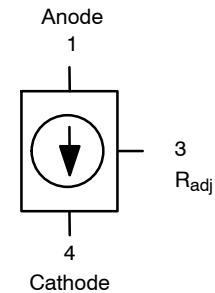
- Automobile: Chevron Side Mirror Markers, Cluster, Display & Instrument Backlighting, CHMSL, Map Light
- AC Lighting Panels, Display Signage, Decorative Lighting, Channel Lettering
- Switch Contact Wetting
- Application Note AND8391/D – Power Dissipation Considerations
- Application Note AND8349/D – Automotive CHMSL



ON Semiconductor®

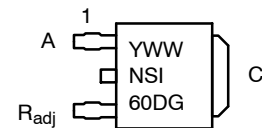
<http://onsemi.com>

$I_{reg(SS)} = 60 - 100 \text{ mA}$   
@  $V_{ak} = 7.5 \text{ V}$



DPAK  
CASE 369C

### MARKING DIAGRAM



Y = Year  
WW = Work Week  
NSI60D = Specific Device Code  
G = Pb-Free Package

### ORDERING INFORMATION

| Device        | Package           | Shipping†        |
|---------------|-------------------|------------------|
| NSI45060DDT4G | DPAK<br>(Pb-Free) | 2500/Tape & Reel |

†For information on tape and reel specifications, including part orientation and tape sizes, please refer to our Tape and Reel Packaging Specifications Brochure, BRD8011/D.

# NSI45060DDT4G

## MAXIMUM RATINGS (T<sub>A</sub> = 25°C unless otherwise noted)

| Rating   | Symbol                            | Value       | Unit               |
|--|-----------------------------------|-------------|--------------------|
| Anode-Cathode Voltage                            | V <sub>AK</sub> Max               | 45          | V                  |
| Reverse Voltage                                  | V <sub>R</sub>                    | 500         | mV                 |
| Operating and Storage Junction Temperature Range | T <sub>J</sub> , T <sub>stg</sub> | -55 to +150 | °C                 |
| ESD Rating:                                      | Human Body Model<br>Machine Model | ESD         | Class 2<br>Class B |

Stresses exceeding Maximum Ratings may damage the device. Maximum Ratings are stress ratings only. Functional operation above the Recommended Operating Conditions is not implied. Extended exposure to stresses above the Recommended Operating Conditions may affect device reliability.

## ELECTRICAL CHARACTERISTICS (T<sub>A</sub> = 25°C unless otherwise noted)

| Characteristic  | Symbol                | Min  | Typ | Max   | Unit |
|---|-----------------------|------|-----|-------|------|
| Steady State Current @ V <sub>AK</sub> = 7.5 V (Note 1) | I <sub>reg(SS)</sub>  | 51   | 60  | 69    | mA   |
| Voltage Overhead (Note 2)                               | V <sub>overhead</sub> |      | 1.8 |       | V    |
| Pulse Current @ V <sub>AK</sub> = 7.5 V (Note 3)        | I <sub>reg(P)</sub>   | 54.7 | 66  | 76.95 | mA   |
| Capacitance @ V <sub>AK</sub> = 7.5 V (Note 4)          | C                     |      | 17  |       | pF   |
| Capacitance @ V <sub>AK</sub> = 0 V (Note 4)            | C                     |      | 70  |       | pF   |

- I<sub>reg(SS)</sub> steady state is the voltage (V<sub>AK</sub>) applied for a time duration ≥ 80 sec, using FR-4 @ 300 mm<sup>2</sup> 2 oz. Copper traces, in still air.
- V<sub>overhead</sub> = V<sub>in</sub> - V<sub>LEDs</sub>. V<sub>overhead</sub> is typical value for 65% I<sub>reg(SS)</sub>.
- I<sub>reg(P)</sub> non-repetitive pulse test. Pulse width t ≤ 300 μsec.
- f = 1 MHz, 0.02 V RMS.

## THERMAL CHARACTERISTICS

| Characteristic  | Symbol                            | Max           | Unit        |
|---|-----------------------------------|---------------|-------------|
| Total Device Dissipation (Note 5) T <sub>A</sub> = 25°C<br>Derate above 25°C  | P <sub>D</sub>                    | 1771<br>14.16 | mW<br>mW/°C |
| Thermal Resistance, Junction-to-Ambient (Note 5)                              | R <sub>θJA</sub>                  | 70.6          | °C/W        |
| Thermal Reference, Junction-to-Lead 4 (Note 5)                                | R <sub>ψJL4</sub>                 | 6.8           | °C/W        |
| Total Device Dissipation (Note 6) T <sub>A</sub> = 25°C<br>Derate above 25°C  | P <sub>D</sub>                    | 2083<br>16.67 | mW<br>mW/°C |
| Thermal Resistance, Junction-to-Ambient (Note 6)                              | R <sub>θJA</sub>                  | 60            | °C/W        |
| Thermal Reference, Junction-to-Lead 4 (Note 6)                                | R <sub>ψJL4</sub>                 | 6.3           | °C/W        |
| Total Device Dissipation (Note 7) T <sub>A</sub> = 25°C<br>Derate above 25°C  | P <sub>D</sub>                    | 2080<br>16.64 | mW<br>mW/°C |
| Thermal Resistance, Junction-to-Ambient (Note 7)                              | R <sub>θJA</sub>                  | 60.1          | °C/W        |
| Thermal Reference, Junction-to-Lead 4 (Note 7)                                | R <sub>ψJL4</sub>                 | 6.5           | °C/W        |
| Total Device Dissipation (Note 8) T <sub>A</sub> = 25°C<br>Derate above 25°C  | P <sub>D</sub>                    | 2441<br>19.53 | mW<br>mW/°C |
| Thermal Resistance, Junction-to-Ambient (Note 8)                              | R <sub>θJA</sub>                  | 51.2          | °C/W        |
| Thermal Reference, Junction-to-Lead 4 (Note 8)                                | R <sub>ψJL4</sub>                 | 5.9           | °C/W        |
| Total Device Dissipation (Note 9) T <sub>A</sub> = 25°C<br>Derate above 25°C  | P <sub>D</sub>                    | 2309<br>18.47 | mW<br>mW/°C |
| Thermal Resistance, Junction-to-Ambient (Note 9)                              | R <sub>θJA</sub>                  | 54.1          | °C/W        |
| Thermal Reference, Junction-to-Lead 4 (Note 9)                                | R <sub>ψJL4</sub>                 | 6.2           | °C/W        |
| Total Device Dissipation (Note 10) T <sub>A</sub> = 25°C<br>Derate above 25°C | P <sub>D</sub>                    | 2713<br>21.71 | mW<br>mW/°C |
| Thermal Resistance, Junction-to-Ambient (Note 10)                             | R <sub>θJA</sub>                  | 46.1          | °C/W        |
| Thermal Reference, Junction-to-Lead 4 (Note 10)                               | R <sub>ψJL4</sub>                 | 5.7           | °C/W        |
| Junction and Storage Temperature Range  | T <sub>J</sub> , T <sub>stg</sub> | -55 to +150   | °C          |

NOTE: Lead measurements are made by non-contact methods such as IR with treated surface to increase emissivity to 0.9.

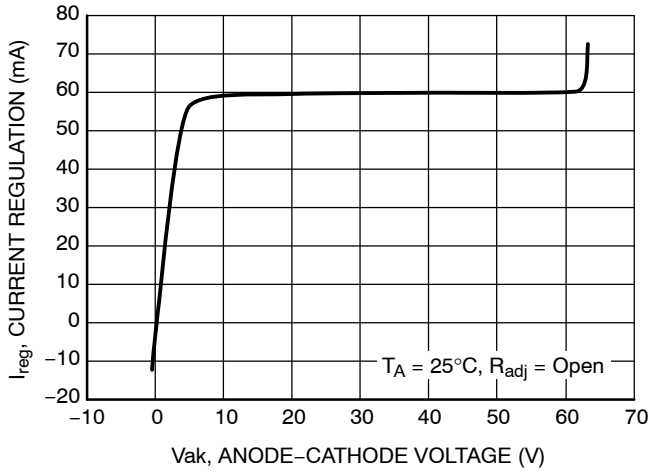
Lead temperature measurement by attaching a T/C may yield values as high as 30% higher °C/W values based upon empirical measurements and method of attachment.

- FR-4 @ 300 mm<sup>2</sup>, 1 oz. copper traces, still air.
- FR-4 @ 300 mm<sup>2</sup>, 2 oz. copper traces, still air.
- FR-4 @ 500 mm<sup>2</sup>, 1 oz. copper traces, still air.
- FR-4 @ 500 mm<sup>2</sup>, 2 oz. copper traces, still air.
- FR-4 @ 700 mm<sup>2</sup>, 1 oz. copper traces, still air.
- FR-4 @ 700 mm<sup>2</sup>, 2 oz. copper traces, still air.

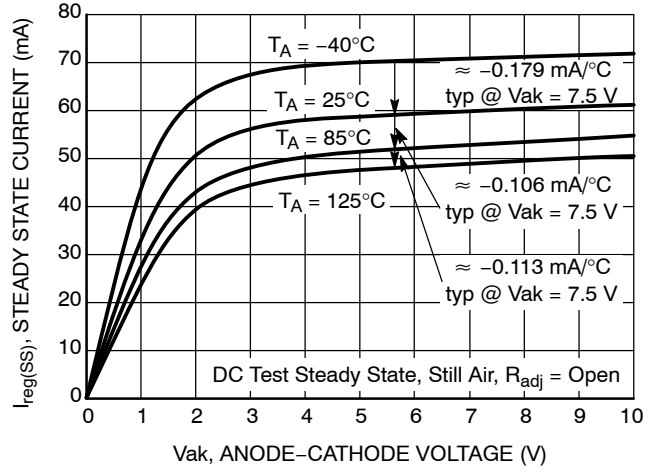
# NSI45060DDT4G

## TYPICAL PERFORMANCE CURVES

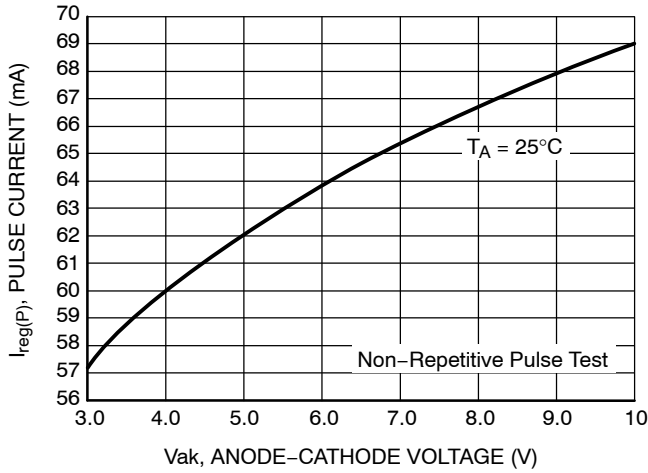
Minimum FR-4 @ 300 mm<sup>2</sup>, 2 oz Copper Trace, Still Air



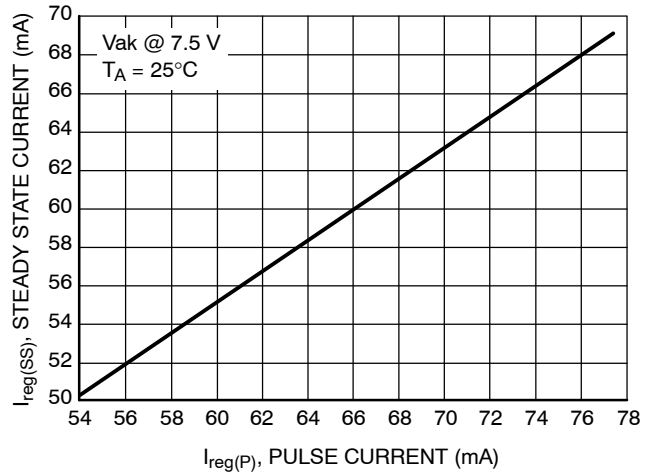
**Figure 1. General Performance Curve for CCR**



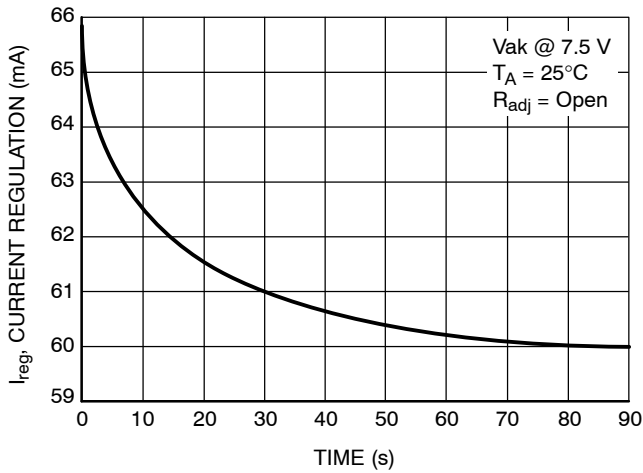
**Figure 2. Steady State Current ( $I_{reg(SS)}$ ) vs. Anode-Cathode Voltage ( $V_{ak}$ )**



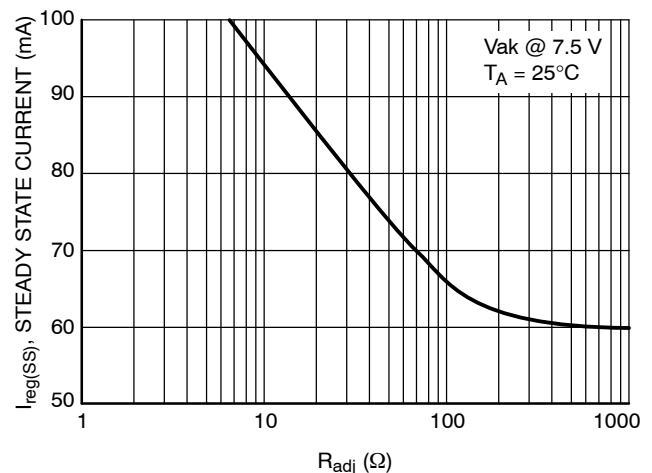
**Figure 3. Pulse Current ( $I_{reg(P)}$ ) vs. Anode-Cathode Voltage ( $V_{ak}$ )**



**Figure 4. Steady State Current vs. Pulse Current Testing**

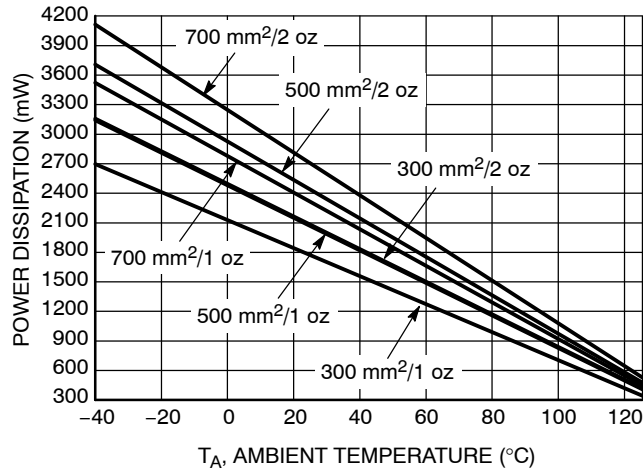


**Figure 5. Current Regulation vs. Time**



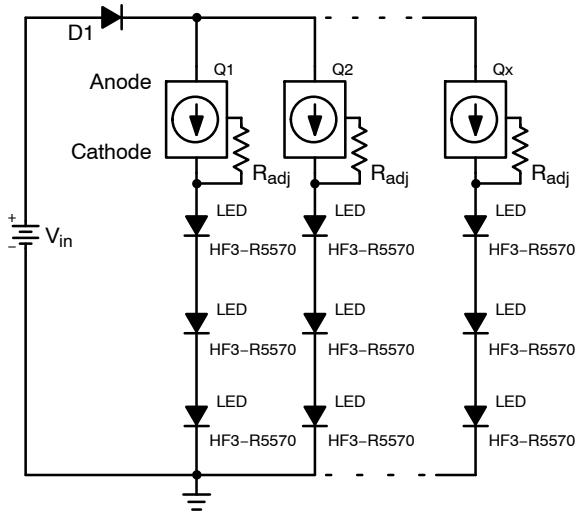
**Figure 6.  $I_{reg(SS)}$  vs.  $R_{adj}$**

# NSI45060DDT4G



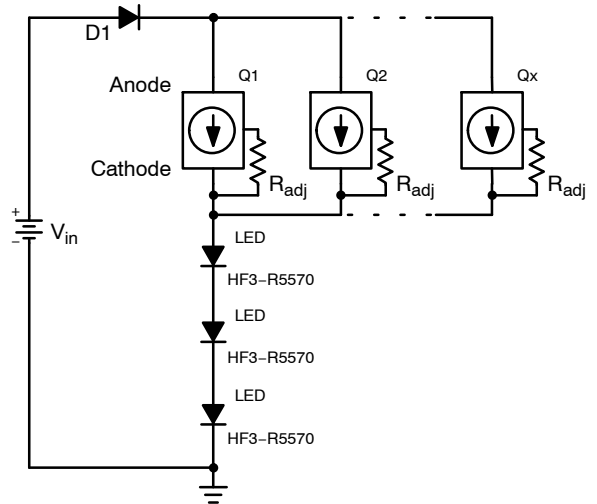
**Figure 7. Power Dissipation vs. Ambient Temperature @  $T_J = 150^\circ\text{C}$**

## APPLICATIONS



**Figure 8. Typical Application Circuit (30 mA each LED String)**

Number of LED's that can be connected is determined by:  
**D1 is a reverse battery protection diode**  
 $\text{LED's} = (V_{in} - Q_X V_F - D1 V_F) / \text{LED } V_F$   
**Example:**  $V_{in} = 12 \text{ Vdc}$ ,  $Q_X V_F = 3.5 \text{ Vdc}$ ,  $D1 V_F = 0.7 \text{ V}$   
 $\text{LED } V_F = 2.2 \text{ Vdc @ } 30 \text{ mA}$   
 $(12 \text{ Vdc} - 4.2 \text{ Vdc}) / 2.2 \text{ Vdc} = 3 \text{ LEDs in series.}$



**Figure 9. Typical Application Circuit (90 mA each LED String)**

Number of LED's that can be connected is determined by:  
**D1 is a reverse battery protection diode**  
**Example:**  $V_{in} = 12 \text{ Vdc}$ ,  $Q_X V_F = 3.5 \text{ Vdc}$ ,  $D1 V_F = 0.7 \text{ V}$   
 $\text{LED } V_F = 2.6 \text{ Vdc @ } 90 \text{ mA}$   
 $(12 \text{ Vdc} - (3.5 + 0.7 \text{ Vdc})) / 2.6 \text{ Vdc} = 3 \text{ LEDs in series.}$   
**Number of Drivers = LED current / 30 mA**  
 $90 \text{ mA} / 30 \text{ mA} = 3 \text{ Drivers (Q1, Q2, Q3)}$

Comparison of LED Circuit using CCR vs. Resistor Biasing

| ON Semiconductor CCR Design   | Resistor Biased Design  |
|---|---|
| Constant brightness over full Supply Voltage (more efficient), see Figure 10                    | Large variations in brightness over full Automotive Supply Voltage                  |
| Little variation of power in LEDs, see Figure 11  | Large variations of current (power) in LEDs   |
| Constant current extends LED strings lifetime, see Figure 10                                    | High Supply Voltage/ Higher Current in LED strings limits lifetime                  |
| Current decreases as voltage increases, see Figure 10   | Current increases as voltage increases  |
| Current supplied to LED string decreases as temperature increases (self-limiting), see Figure 2 | LED current decreases as temperature increases                                      |
| Single resistor is used for current select  | Requires costly inventory (need for several resistor values to match LED intensity) |
| Fewer components, less board space required   | More components, more board space required  |
| Surface mount component   | Through-hole components   |

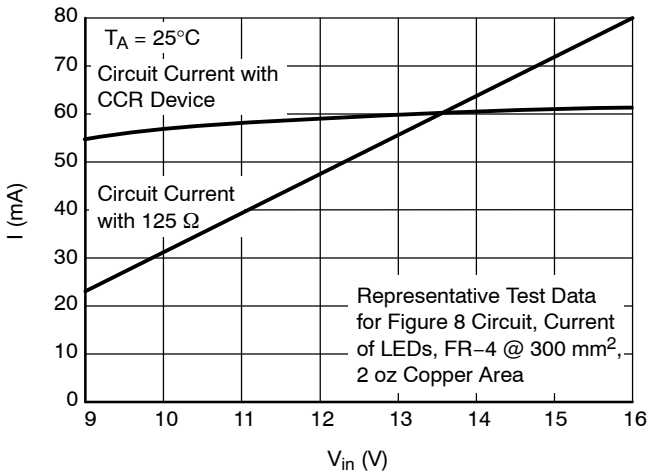


Figure 10. Series Circuit Current

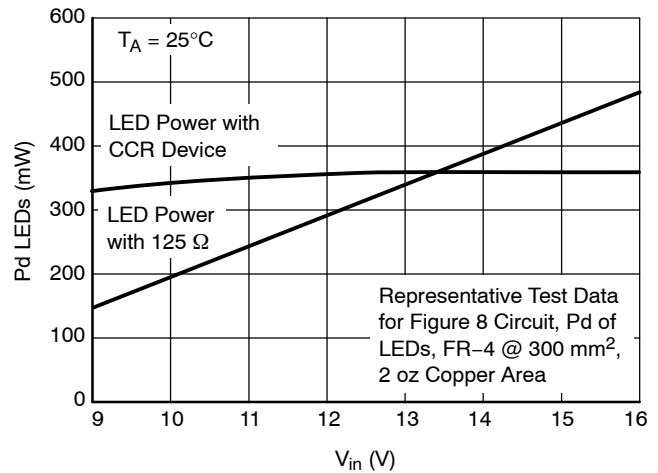


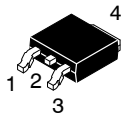
Figure 11. LED Power

Current Regulation: Pulse Mode ( $I_{reg(P)}$ ) vs DC Steady-State ( $I_{reg(SS)}$ )

There are two methods to measure current regulation: Pulse mode ( $I_{reg(P)}$ ) testing is applicable for factory and incoming inspection of a CCR where test times are a minimum. ( $t \leq 300 \mu s$ ). DC Steady-State ( $I_{reg(SS)}$ ) testing is applicable for application verification where the CCR will be operational for seconds, minutes, or even hours. ON Semiconductor has correlated the difference in  $I_{reg(P)}$  to

$I_{reg(SS)}$  for stated board material, size, copper area and copper thickness.  $I_{reg(P)}$  will always be greater than  $I_{reg(SS)}$  due to the die temperature rising during  $I_{reg(SS)}$ . This heating effect can be minimized during circuit design with the correct selection of board material, metal trace size and weight, for the operating current, voltage, board operating temperature ( $T_A$ ) and package. (Refer to Thermal Characteristics table).

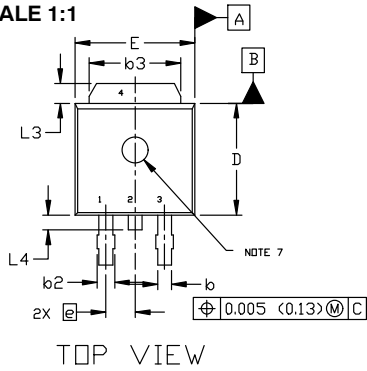
# MECHANICAL CASE OUTLINE PACKAGE DIMENSIONS



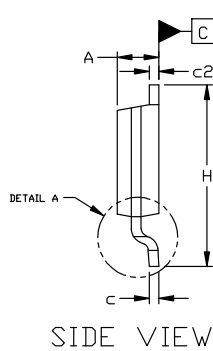
## DPAK (SINGLE GAUGE) CASE 369C ISSUE G

DATE 31 MAY 2023

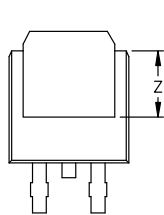
SCALE 1:1



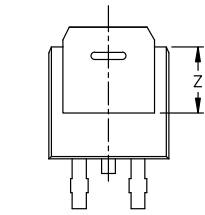
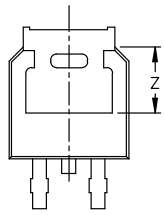
TOP VIEW



SIDE VIEW

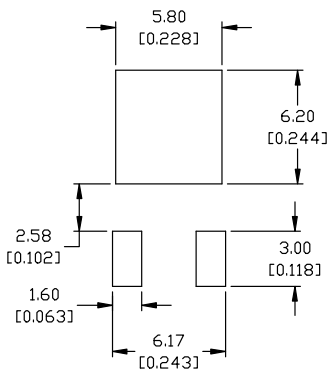


BOTTOM VIEW



BOTTOM VIEW

ALTERNATE CONSTRUCTIONS



### RECOMMENDED MOUNTING FOOTPRINT\*

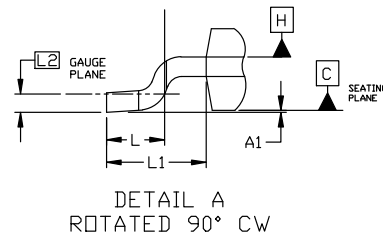
\*FOR ADDITIONAL INFORMATION ON OUR Pb-FREE STRATEGY AND SOLDERING DETAILS, PLEASE DOWNLOAD THE ON SEMICONDUCTOR SOLDERING AND MOUNTING TECHNIQUES REFERENCE MANUAL, SOLDERM/D.

- |  |  |   |   |  |
|--|--|---|---|--|
| <b>STYLE 1:</b><br>PIN 1. BASE<br>2. COLLECTOR<br>3. EMITTER<br>4. COLLECTOR | <b>STYLE 2:</b><br>PIN 1. GATE<br>2. DRAIN<br>3. SOURCE<br>4. DRAIN          | <b>STYLE 3:</b><br>PIN 1. ANODE<br>2. CATHODE<br>3. ANODE<br>4. CATHODE | <b>STYLE 4:</b><br>PIN 1. CATHODE<br>2. ANODE<br>3. GATE<br>4. ANODE              | <b>STYLE 5:</b><br>PIN 1. GATE<br>2. ANODE<br>3. CATHODE<br>4. ANODE     |
| <b>STYLE 6:</b><br>PIN 1. MT1<br>2. MT2<br>3. GATE<br>4. MT2                 | <b>STYLE 7:</b><br>PIN 1. GATE<br>2. COLLECTOR<br>3. EMITTER<br>4. COLLECTOR | <b>STYLE 8:</b><br>PIN 1. N/C<br>2. CATHODE<br>3. ANODE<br>4. CATHODE   | <b>STYLE 9:</b><br>PIN 1. ANODE<br>2. CATHODE<br>3. RESISTOR ADJUST<br>4. CATHODE | <b>STYLE 10:</b><br>PIN 1. CATHODE<br>2. ANODE<br>3. CATHODE<br>4. ANODE |

### NOTES:

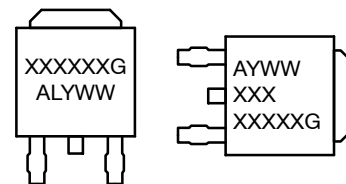
- DIMENSIONING AND TOLERANCING ASME Y14.5M, 1994.
- CONTROLLING DIMENSION: INCHES
- THERMAL PAD CONTOUR OPTIONAL WITHIN DIMENSIONS b3, L3, AND Z.
- DIMENSIONS D AND E DO NOT INCLUDE MOLD FLASH, PROTRUSIONS, OR BURRS. MOLD FLASH, PROTRUSIONS, OR GATE BURRS SHALL NOT EXCEED 0.006 INCHES PER SIDE.
- DIMENSIONS D AND E ARE DETERMINED AT THE OUTERMOST EXTREMES OF THE PLASTIC BODY.
- DATUMS A AND B ARE DETERMINED AT DATUM PLANE H.
- OPTIONAL MOLD FEATURE.

| DIM | INCHES |       | MILLIMETERS |       |
|-----|--------|-------|-------------|-------|
|     | MIN.   | MAX.  | MIN.        | MAX.  |
| A   | 0.086  | 0.094 | 2.18        | 2.38  |
| A1  | 0.000  | 0.005 | 0.00        | 0.13  |
| b   | 0.025  | 0.035 | 0.63        | 0.89  |
| b2  | 0.028  | 0.045 | 0.72        | 1.14  |
| b3  | 0.180  | 0.215 | 4.57        | 5.46  |
| c   | 0.018  | 0.024 | 0.46        | 0.61  |
| c2  | 0.018  | 0.024 | 0.46        | 0.61  |
| D   | 0.235  | 0.245 | 5.97        | 6.22  |
| E   | 0.250  | 0.265 | 6.35        | 6.73  |
| e   | 0.090  | BSC   | 2.29        | BSC   |
| H   | 0.370  | 0.410 | 9.40        | 10.41 |
| L   | 0.055  | 0.070 | 1.40        | 1.78  |
| L1  | 0.114  | REF   | 2.90        | REF   |
| L2  | 0.020  | BSC   | 0.51        | BSC   |
| L3  | 0.035  | 0.050 | 0.89        | 1.27  |
| L4  | ----   | 0.040 | ---         | 1.01  |
| Z   | 0.155  | ----  | 3.93        | ---   |



DETAIL A  
ROTATED 90° CW

### GENERIC MARKING DIAGRAM\*



- IC**  
 XXXXXX = Device Code  
 A = Assembly Location  
 L = Wafer Lot  
 Y = Year  
 WW = Work Week  
 G = Pb-Free Package
- Discrete**  
 AYWW  
 XXX  
 XXXXXG

\*This information is generic. Please refer to device data sheet for actual part marking. Pb-Free indicator, "G" or microdot "•", may or may not be present. Some products may not follow the Generic Marking.

|                         |                            |  |
|-------------------------|----------------------------|--|
| <b>DOCUMENT NUMBER:</b> | <b>98AON10527D</b>         | Electronic versions are uncontrolled except when accessed directly from the Document Repository. Printed versions are uncontrolled except when stamped "CONTROLLED COPY" in red. |
| <b>DESCRIPTION:</b>     | <b>DPAK (SINGLE GAUGE)</b> | <b>PAGE 1 OF 1</b>   |

onsemi and onsemi are trademarks of Semiconductor Components Industries, LLC dba onsemi or its subsidiaries in the United States and/or other countries. onsemi reserves the right to make changes without further notice to any products herein. onsemi makes no warranty, representation or guarantee regarding the suitability of its products for any particular purpose, nor does onsemi assume any liability arising out of the application or use of any product or circuit, and specifically disclaims any and all liability, including without limitation special, consequential or incidental damages. onsemi does not convey any license under its patent rights nor the rights of others.

**onsemi**, **Onsemi**, and other names, marks, and brands are registered and/or common law trademarks of Semiconductor Components Industries, LLC dba "**onsemi**" or its affiliates and/or subsidiaries in the United States and/or other countries. **onsemi** owns the rights to a number of patents, trademarks, copyrights, trade secrets, and other intellectual property. A listing of **onsemi**'s product/patent coverage may be accessed at [www.onsemi.com/site/pdf/Patent-Marking.pdf](http://www.onsemi.com/site/pdf/Patent-Marking.pdf). **onsemi** reserves the right to make changes at any time to any products or information herein, without notice. The information herein is provided "as-is" and **onsemi** makes no warranty, representation or guarantee regarding the accuracy of the information, product features, availability, functionality, or suitability of its products for any particular purpose, nor does **onsemi** assume any liability arising out of the application or use of any product or circuit, and specifically disclaims any and all liability, including without limitation special, consequential or incidental damages. Buyer is responsible for its products and applications using **onsemi** products, including compliance with all laws, regulations and safety requirements or standards, regardless of any support or applications information provided by **onsemi**. "Typical" parameters which may be provided in **onsemi** data sheets and/or specifications can and do vary in different applications and actual performance may vary over time. All operating parameters, including "Typicals" must be validated for each customer application by customer's technical experts. **onsemi** does not convey any license under any of its intellectual property rights nor the rights of others. **onsemi** products are not designed, intended, or authorized for use as a critical component in life support systems or any FDA Class 3 medical devices or medical devices with a same or similar classification in a foreign jurisdiction or any devices intended for implantation in the human body. Should Buyer purchase or use **onsemi** products for any such unintended or unauthorized application, Buyer shall indemnify and hold **onsemi** and its officers, employees, subsidiaries, affiliates, and distributors harmless against all claims, costs, damages, and expenses, and reasonable attorney fees arising out of, directly or indirectly, any claim of personal injury or death associated with such unintended or unauthorized use, even if such claim alleges that **onsemi** was negligent regarding the design or manufacture of the part. **onsemi** is an Equal Opportunity/Affirmative Action Employer. This literature is subject to all applicable copyright laws and is not for resale in any manner.

## ADDITIONAL INFORMATION

### TECHNICAL PUBLICATIONS:

Technical Library: [www.onsemi.com/design/resources/technical-documentation](http://www.onsemi.com/design/resources/technical-documentation)  
onsemi Website: [www.onsemi.com](http://www.onsemi.com)

### ONLINE SUPPORT: [www.onsemi.com/support](http://www.onsemi.com/support)

For additional information, please contact your local Sales Representative at [www.onsemi.com/support/sales](http://www.onsemi.com/support/sales)