

1

2

3

4

5

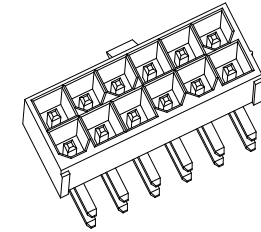
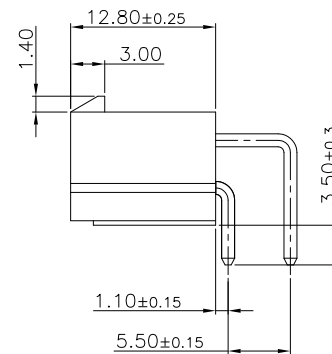
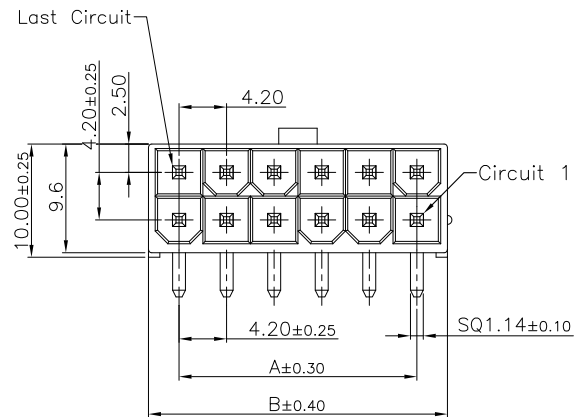
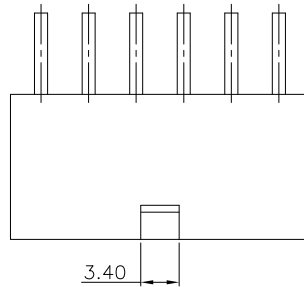

## Specifications:

Current Rating:9.0A AC/DC

Voltage Rating:600V AC/DC

Contact Resistance:10m ohm. Max.

Insulation Resistance:1000M ohm. Min.

Withstanding Voltage:1500V AC For One Minute

Operating Temperature Range:-40°C To +105°C

## Materials:

Insulator:Nylon66 (UL94V-0)

Insulator Color:White

Terminal:Brass

Plating:Tin Plated

## Dimension Information:

Circuits	Dim A	Dim B	Circuits	Dim A	Dim B
2	—	5.4	14	25.2	30.6
4	4.2	9.6	16	29.4	34.8
6	8.4	13.8	18	33.6	39.0
8	12.6	18.0	20	37.8	43.2
10	16.8	22.2	22	42.0	47.4
12	21.0	26.4	24	46.2	51.6

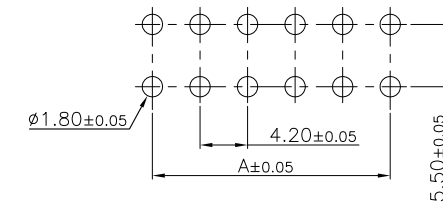

RECOMMENDED P.C.B. LAYOUT

RoHS Compliant

DRAWN:

GENERAL TOLERANCE:

.X=±0.40

.XX=±0.30

**CnC Tech**

Industrial Cable and Connector Technology

CHECKED:

UNIT: MM

DESCRIPTION:

CONN HEADER R/A DUAL 94V-0

SIZE

APPROVAL:

SCALE:1:1

PART NO:

4282-1-0200-XX-SP

A4

REV

DATE

FILE

BY

PROJECTION:

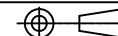

A

B

C

D

1

2

3

4

5

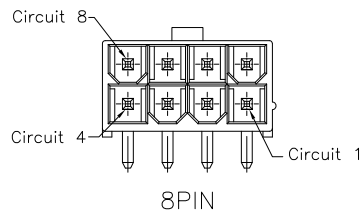

8PIN

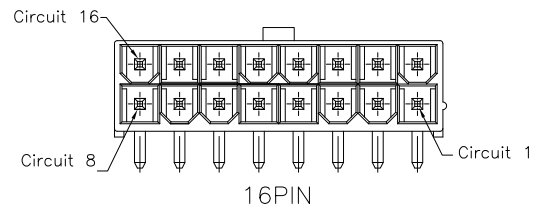

16PIN

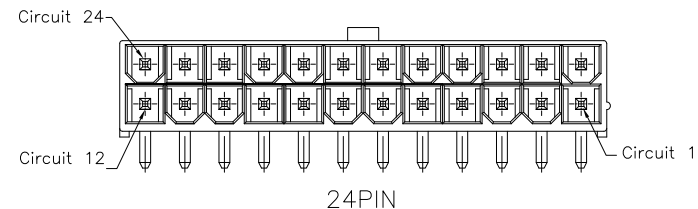

24PIN

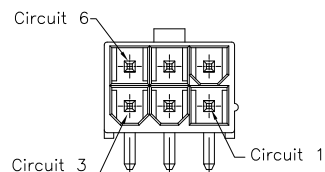

6PIN

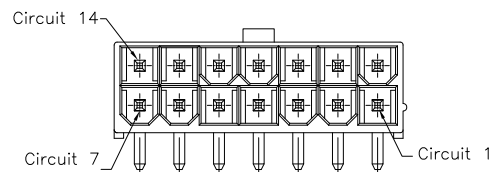

14PIN

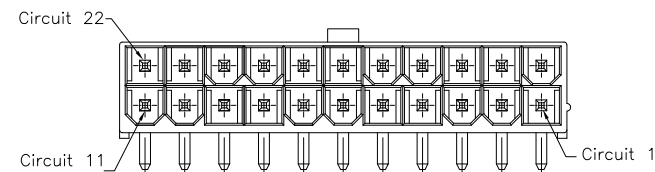

22PIN

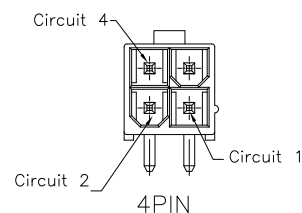

4PIN

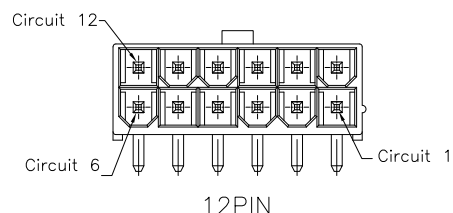

12PIN

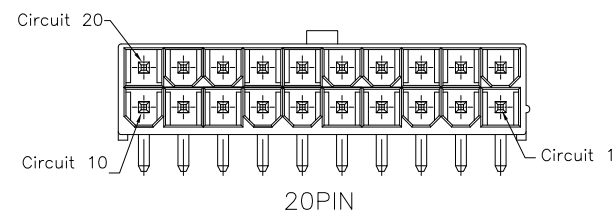

20PIN

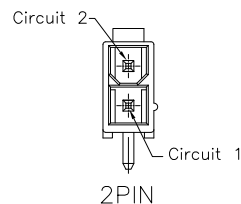

2PIN

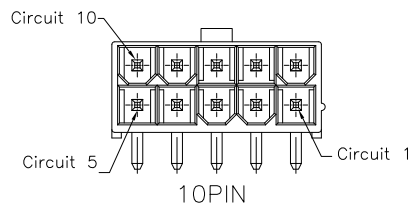

10PIN

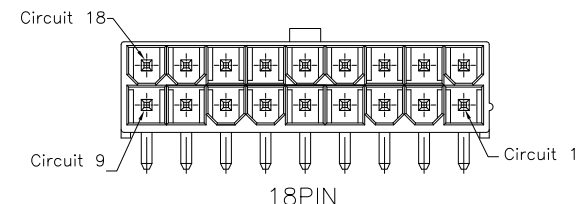

18PIN

2~24P Protection Key Drawing(Ref.)

RoHS Compliant

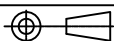
				DRAWN:	GENERAL TOLERANCE: .X=±0.40 .XX=±0.30	<h1 style="color: red; margin: 0;">CnC Tech</h1> <p style="margin: 0;">Industrial Cable and Connector Technology</p>	
				CHECKED:	UNIT: MM SCALE: 1:1		DESCRIPTION: CONN HEADER R/A DUAL 94V-0
				APPROVAL:	SHEET: 2 / 4	PART NO:	A4
REV	DATE	FILE	BY		PROJECTION: 	4282-1-0200-XX-SP	

A

B

C

D

1

2

3

4

5

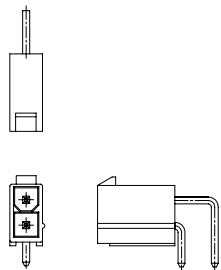

4282-1-0200-02-SP

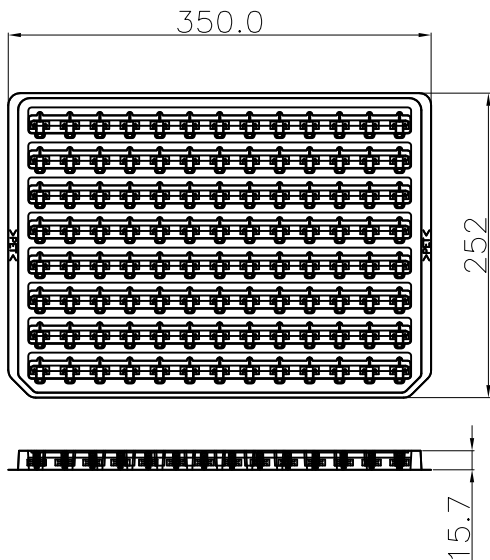

Note:  
 1.Dimension:  
 Tray Size:350(L)x252(W)x15.7(H) (mm)  
 Carton Size:360(L)x270(W)x300(H) (mm)  
 2.Quantity:  
 18 Tray/Carton

Pin	Pcs/Tray	Tray/Carton	Pcs/Carton
2	104	18	1872

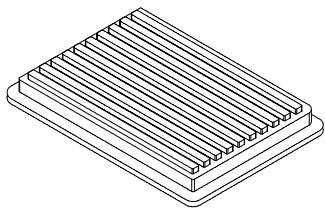

Tray

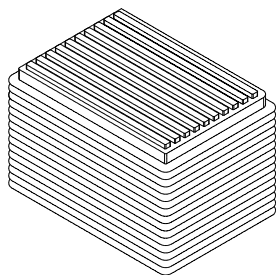

18Trays

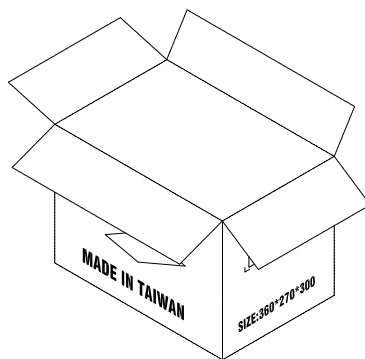

Carton

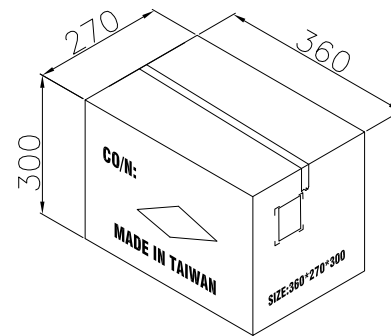

Carton

REV	DATE	FILE	BY

DRAWN:	GENERAL TOLERANCE: .X=±0.2 .XX=±0.15
CHECKED:	
APPROVAL:	UNIT: MM
	SCALE:
	SHEET: 3 / 4
	PROJECTION:

<b>CnC Tech</b> Industrial Cable and Connector Technology	
DESCRIPTION: CONN HEADER R/A DUAL 94V-0 PACKING	SIZE
PART NO: 4282-1-0200-XX-SP	A4

A

B

C

D

1

2

3

4

5



4282-1-0200-XX-SP

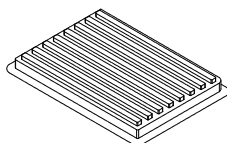

COVER TRAY

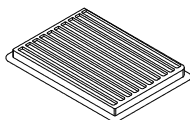

BOTTOM TRAY

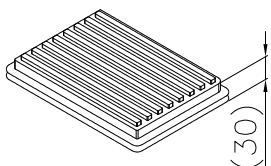

TRAY

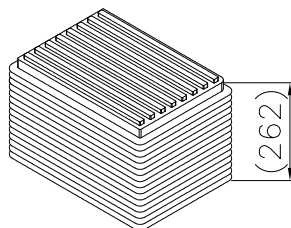

18TRAYS

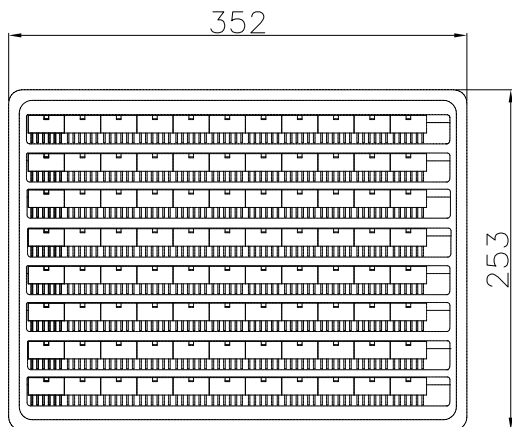

253

352

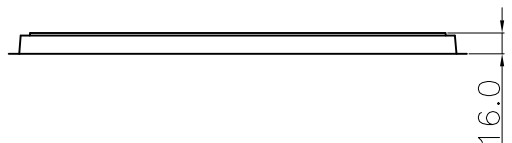

16.0

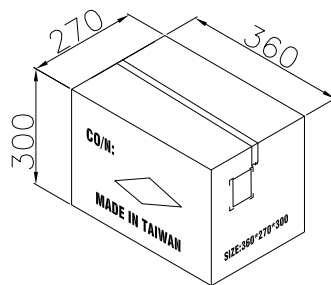

CARTON

Note:

1.Dimension:

Tray Size:352(L)x253(W)x16(H) (mm)

Carton Size:360(L)x270(W)x300(H) (mm)

2.Quantity:

18 Tray/Carton

Pin	PCS/Tray	Tray/Carton	PCS/Carton
4	248	18	4464
6	176	18	3168
8	136	18	2448
10	112	18	2016
12	88	18	1584
14	80	18	1440
16	72	18	1296
18	64	18	1152
20	56	18	1008
22	48	18	864
24	48	18	864

REV	DATE	FILE	BY

DRAWN:	GENERAL TOLERANCE: .X=±0.2 .XX=±0.15
CHECKED:	
APPROVAL:	

UNIT: MM	DESCRIPTION: <b>CONN HEADER R/A DUAL 94V-0 PACKING</b>
SCALE:	
SHEET: 4 / 4	
PROJECTION:	

<b>CnC Tech</b> Industrial Cable and Connector Technology	
PART NO:	<b>4282-1-0200-XX-SP</b>

SIZE	<b>A4</b>