

EVT014

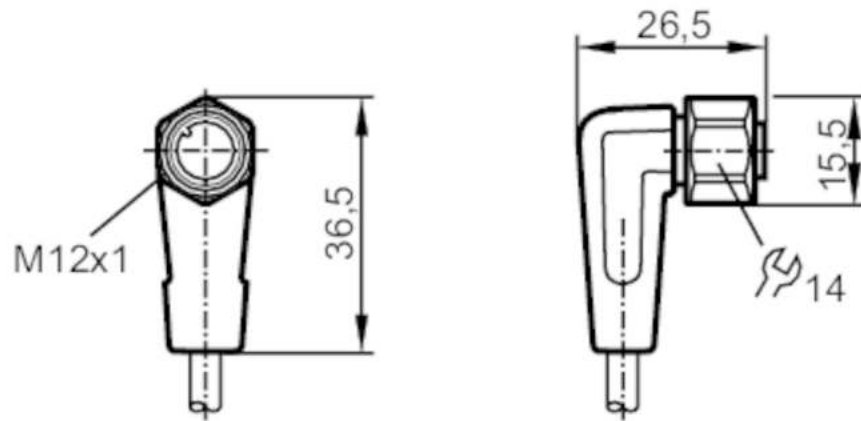

Connecting cable with socket

ADOAH050VAS0010E05



Application	
Special feature	Free from silicone; Gold-plated contacts; Drag chain suitability
Application	hygienic and wet areas in the food industry
Free from silicone	yes
Electrical data	
Operating voltage [V]	< 60 AC/DC
Protection class	II
Max. current load total [A]	4
Overall current rating (UL) [A]	3
Operating conditions	
Ambient temperature [°C]	-25...100
Note on ambient temperature	cULus: ...50
Ambient temperature (moving) [°C]	5...100
Note on ambient temperature (moving)	cULus: ...50
Storage temperature [°C]	-25...55
Storage humidity [%]	10...100
Other climatic conditions for storage according to stated class	1K22/ DIN 60721-3-1
Protection	IP 65; IP 67; IP 68; IP 69K
Mechanical data	
Weight [g]	454.5
Moulded-body material	PVC

EVT014



Connecting cable with socket

ADOAH050VAS0010E05

Material nut	stainless steel (1.4404 / 316L)	
Sealing material	EPDM	
Drag chain suitability	yes	
Drag chain suitability	bending radius for flexible use	min. 10 x cable diameter
	travel speed	max. 3.3 m/s for a horizontal travel length of 5 m and max. acceleration of 5 m/s ²
	bending cycles	> 1 Mio.
	torsional strain	± 180 °/m

Remarks

Pack quantity 1 pcs.

Electrical connection

Cable: 10 m, PVC, orange, Ø 5.1 mm; 5 x 0.34 mm² (42 x Ø 0.1 mm)

Electrical connection - socket

Connector: 1 x M12, angled; coding: A; Moulded body: PVC, orange; Locking: stainless steel (1.4404 / 316L); Sealing: EPDM;
Contacts: gold-plated; Tightening torque: 0.6...1.5 Nm

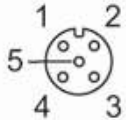

Connection

1	BN
2	WH
3	BU
4	BK
5	GY

Core colours :
BK = black
BN = brown
BU = blue
GY = grey
WH = white