

STB-3/8 TC

RECESSED CONTACTS

.37"(9.5mm) Recessed Type W/Terminal Quick-Connect



Contact Size: .37"×.92"(9.5mm×23.3mm)

Standard Magnet Size: .37"×.58"(9.5mm×14.8mm)



Standard Gap: .6"(15mm)

Colors: White, Brown



STB-3/8 TC: Terminal Connect, No Leads.

Specifications

Part Number	Gap Inch(mm)	Loop Open/Closed	Reed Form	Max. Contact Rating (W)	Max. Initial Contact Resistance (mΩ)	Max. Switching Voltage (V)	Max. Switching Current (A)
STB-3/8 TC	.6"(15)	CLOSED	Normally Open	10	100	AC110/DC100	0.5
STB-3/8 TC WG	1"(25)	CLOSED	Normally Open	10	100	AC110/DC100	0.5
STB-3/8 TC DM	.5"(12.5)	CLOSED	Normally Open	10	100	AC110/DC100	0.5
STB-3/8 TC FLAT	.5"(12.5)	CLOSED	Normally Open	10	100	AC110/DC100	0.5
STB-3/8B TC	.5"(12.5)	OPEN	Normally Closed	10	100	AC110/DC100	0.5

OPERATING TEMPERATURE:-40°C to +60°C

Outline Dimensions

Unit: inch(mm)

STB-3/8 TC

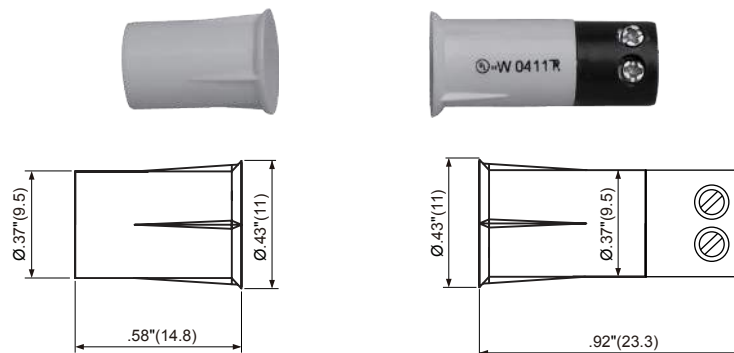

The Best Product Guarantee Since 1984
TANE ALARM PRODUCTS

906 JERICHO TURNPIKE, NEW HYDE PARK, NY 11040
 Tel: 800-852-5050 • 516-328-3351 • Fax: 516-326-9125
 www.tanealarm.com • E-MAIL: info@tanealarm.com

STB-3/8 TC

RECESSED CONTACTS

Outline Dimensions

Unit: inch(mm)

STB-3/8 TC WG



Bare Rare Earth
(BT 3/8"×3/4")

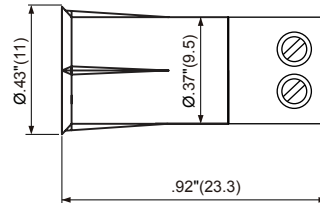
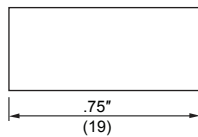

STB-3/8 TC DM



Bare Rare Earth
(BT 3/8"×1/8"DM)

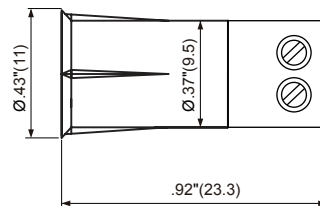
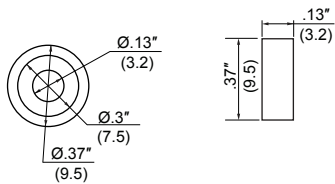

STB-3/8 TC FLAT



Bare Rare Earth
(BT 1/8"×1/4"×1"ADH)

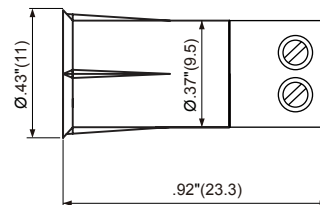
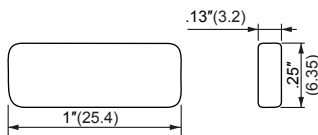

The Best Product Guarantee Since 1984 [®]
TANE ALARM PRODUCTS

906 JERICHO TURNPIKE, NEW HYDE PARK, NY 11040
 Tel: 800-852-5050 • 516-328-3351 • Fax: 516-326-9125
 www.tanealarm.com • E-MAIL: info@tanealarm.com