

## ISL9519TQFNEVAL2Z

### Evaluation Board Setup Procedure

AN1570  
Rev 1.00  
Mar 15, 2011

## Introduction

The ISL9519 is a highly integrated battery charger controller for Li-ion/Li-ion polymer batteries with SMBus interface controlling system voltage, charge current and input current limiting. The evaluation board includes a USB to SMBus interface to allow users to control the ISL9519 from a computer.

## ISL9519TQFNEVAL2Z vs ISL9519EVAL1Z

ISL9519TQFNEVAL2Z is designed for input voltage below 7V (i.e., 5V input) but has protection from input voltage up to 22V. It differs from the design for input voltage >7V (ISL9519EVAL1Z) in 3 ways:

1. ISL9519TQFNEVAL2Z drives both input PFETs with AGATE to turn both ON when adapter voltage is high. ISL9519EVAL1Z drives SGATE ON only when input current is >300mA.
2. ISL9519TQFNEVAL2Z has a circuit that connects input voltage to VDD when the input is less than 5.2V to bypass the internal LDO.
3. ISL9519TQFNEVAL2Z has a zener to protect ADET from voltages >7V absolute maximum if the input voltage is >9.5V.

## What's Inside

This Evaluation Board Kit contains the following materials:

- Qty (1) ISL9519TQFNEVAL2Z Evaluation Board
- Qty (1) USB cable

## What is Needed

The following materials are recommended to perform testing:

- One adjustable 25V/6A power supply
- Two adjustable electronic loads with constant current mode and constant voltage mode
- One Volt Meter
- One 500MHz four-channel oscilloscope with voltage and current probes
- A Personal Computer (PC) with ISL9519 control software and drivers (available at [www.intersil.com](http://www.intersil.com))

Note: The National Instruments Runtime Engine must be installed before connecting the evaluation board to your PC. The Runtime Engine contains driver files required by the New Hardware Wizard.

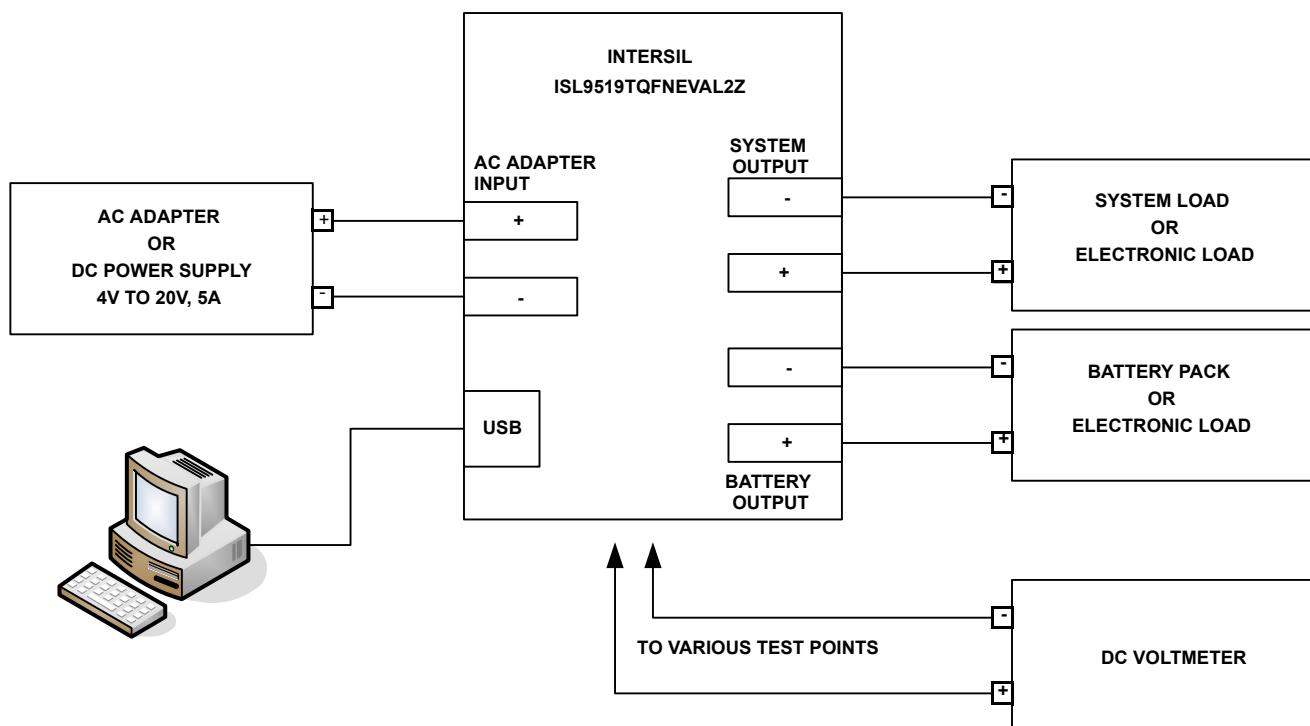

FIGURE 1. ISL9519TQFNEVAL2Z HARDWARE CONNECTION DIAGRAM

## Install the Software

1. Download the ISL9519 CONTROL Software Installer.zip file from [www.intersil.com](http://www.intersil.com). Extract it to a folder on your PC. Navigate to the folder and double click the "Autoexec.exe" file.
2. Click on the "Install or Uninstall ISL9519 CONTROL Software" to run the Installation Wizard.
3. You should now see a window as shown in Figure 3.

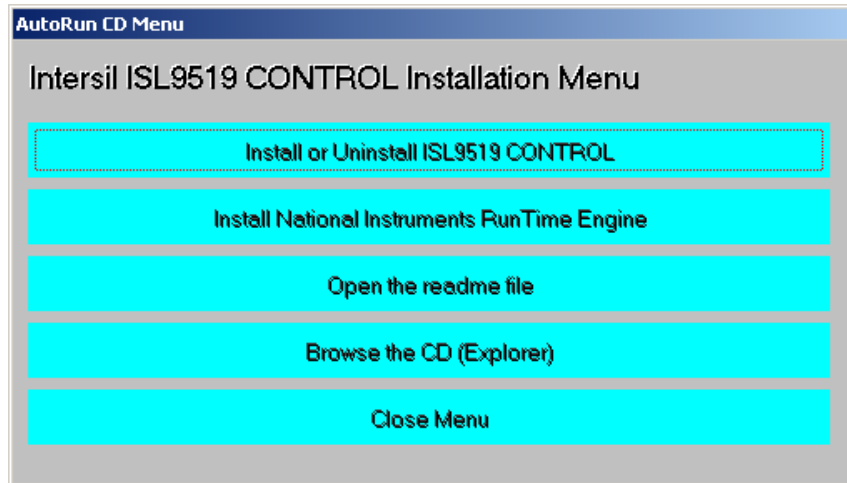

FIGURE 2. AUTORUN CD MENU



FIGURE 3. INSTALLATION WIZARD

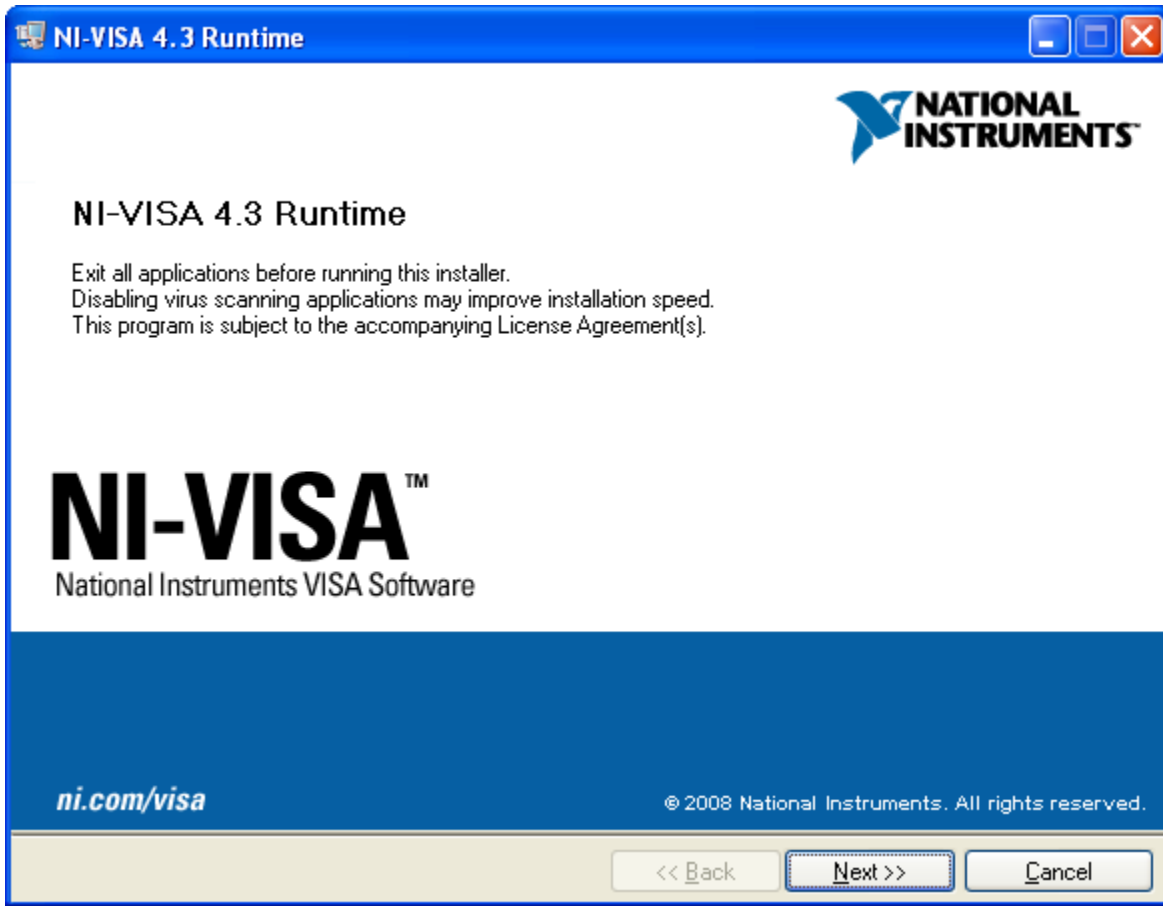

FIGURE 4. NATIONAL INSTRUMENTS RUNTIME ENGINE INSTALLATION WIZARD

In most PCs, the National Instruments Runtime Engine will be installed automatically after the ISL9519 software. You should see the window as shown in Figure 4.

Follow the instructions to install the Runtime Engine. If it does not run automatically, click “Install National Instruments Runtime Engine” on the ISL9519 Control Software Installation Menu (see Figure 2). After installation, click on the “Close Menu” button.

## Driver Installation

After installing the National Instruments Runtime Engine, connect the ISL9519TQFNEVAL2Z evaluation board to the USB port of your PC.

Note: The SMBus part of the ISL9519 and the USB-SMBus interface are powered by the 5V from the USB port on the PC. It is

not necessary to have other power supplies connected to the evaluation board to read or write to the ISL9519.

When WINDOWS detects new hardware, the new hardware wizard should appear. Direct it to look for the driver information file in the "ISL9519 CONTROL Software Installer" folder (extracted from the downloaded file). In some systems, it may be necessary to specify the driver information file (USB-I2C\_WDM.inf).

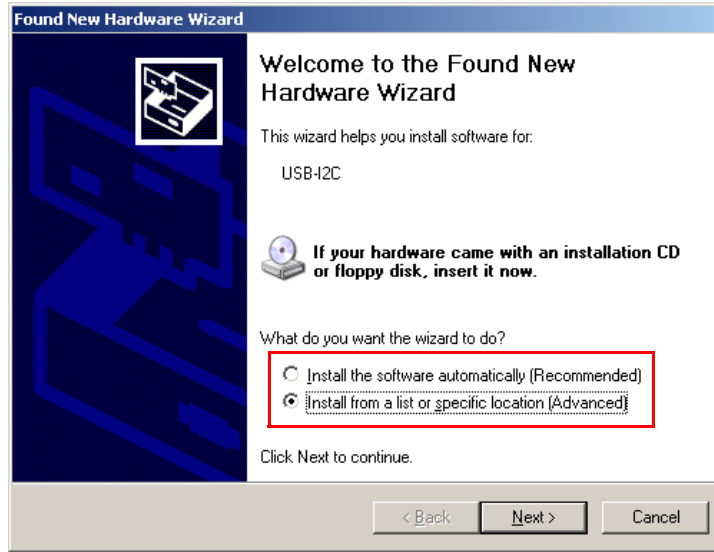

FIGURE 5. SELECT "INSTALL FROM A SPECIFIC LOCATION"

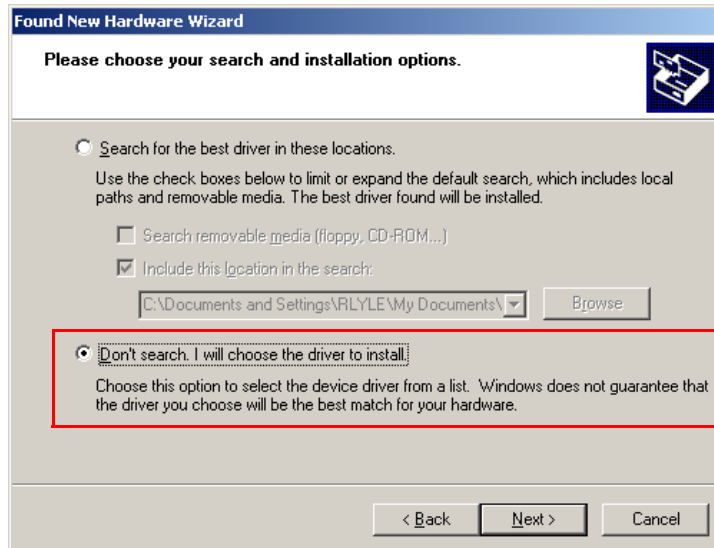
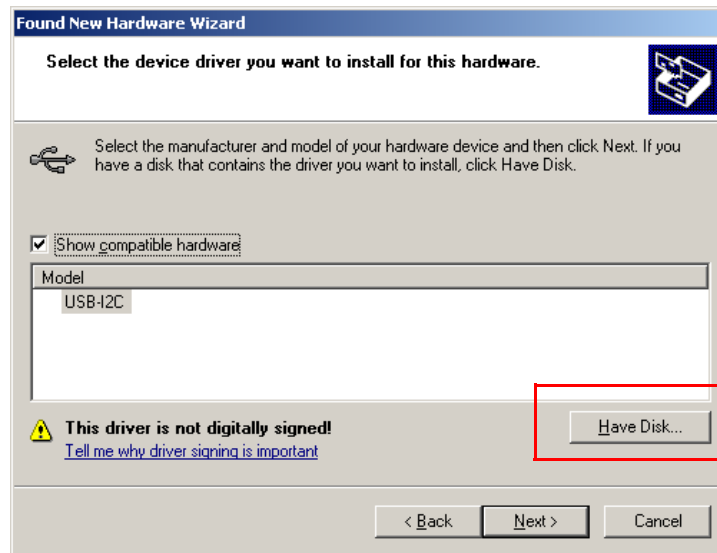
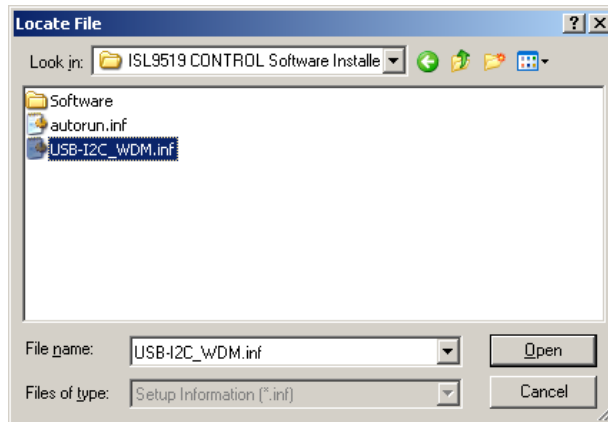

FIGURE 6. SELECT "DON'T SEARCH"



**FIGURE 7. CLICK ON THE “HAVE DISK” BUTTON**

Then hit “Open” and “Next” several times. The hardware wizard should indicate that files are being copied. After file transfer, the hardware wizard should indicate that the new hardware is ready to use.



**FIGURE 8. BROWSE TO THE FOLDER EXTRACTED FROM THE ZIP FILE AND SELECT “USB-I2C\_WDM.INF”**

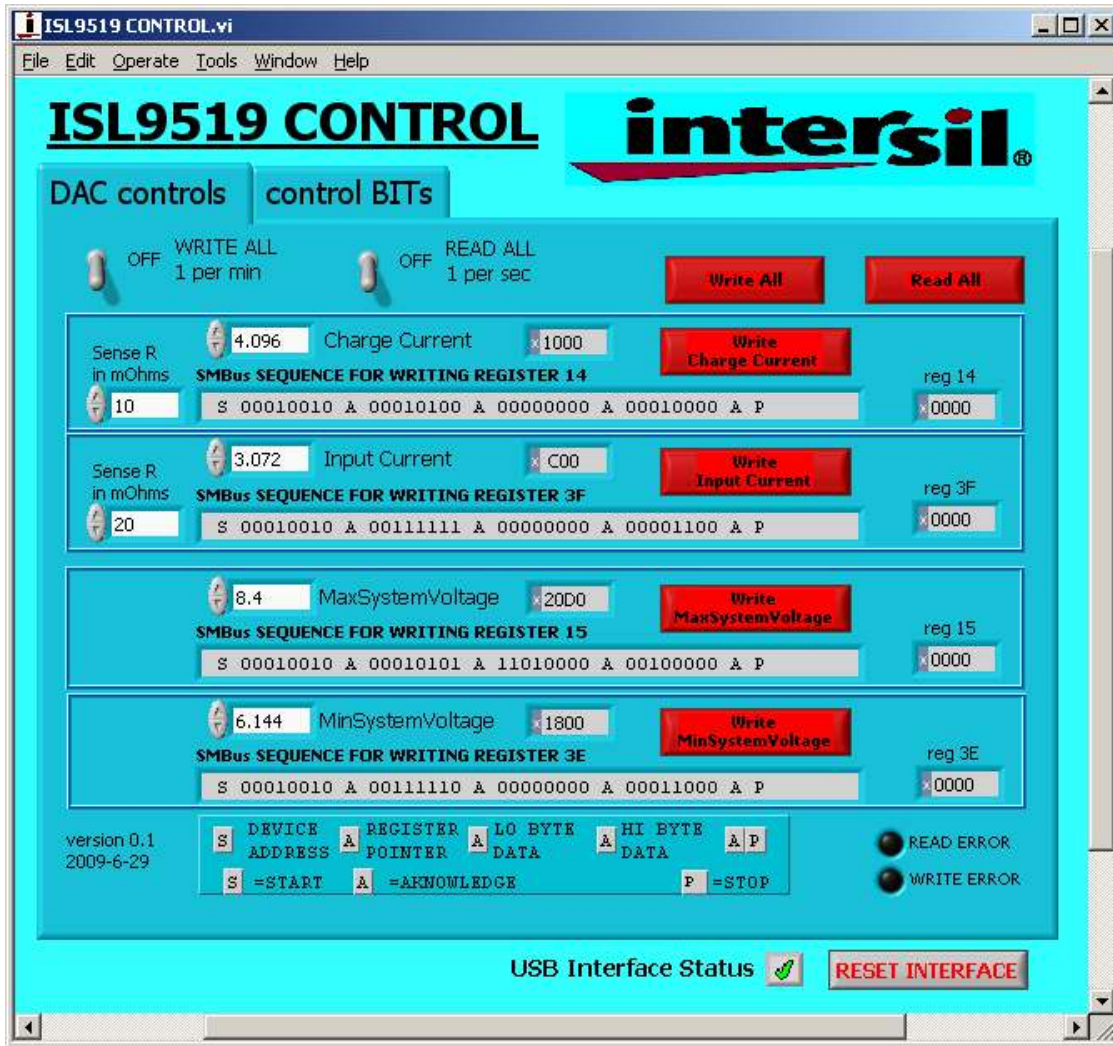

FIGURE 9. ISL9519 CONTROL SOFTWARE SCREEN SHOT

### Run the ISL9519 Application

ISL9519 should now appear in your START/ALL Programs list. Click on it to run the application.

Figure 9 shows a screen shot of the ISL9519 user interface.

### Enable the Output

When power is applied to the ISL9519, the Charge Current and Charge Voltage Registers are 0x0000 and the output is disabled. The output is enabled by writing valid, non-zero values to these 2 registers. See the ISL9519 data sheet for valid values ([FN6773](#)).

The ISL9519 is also disabled if the ACIN pin is below 3.2V. The minimum input voltage can be adjusted on the evaluation board by changing R<sub>6</sub> or R<sub>7</sub> (see Figure 15).

### Description of the User Interface Controls and Display Information

Clicking the “Write All” button will write the indicated SMBus sequences to Registers 14, 15, 3F and 44 in the ISL9519.



Note: The SMBus part of the ISL9519 and the USB interface are powered by the 5V from the USB port on the PC. It is not necessary to have other power supplies connected to the evaluation board to read or write to the ISL9519.

Clicking on the “Read All” button will read all 6 registers in the ISL9519 and display the results in the grey indicators below the Read All button.



If the device and the interface are operating normally, the VendorID (reg FE) and the DeviceID (reg FF) will display as follows:

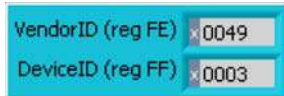

If the VendorID (reg FE) and DeviceID (reg FF) remain 0000 it indicates a communication problem.

If the Visa resource name is blank, it indicates a problem with the USB communication.

Clicking on the “RESET INTERFACE” button may correct the problem. If not, try closing the software, remove power and USB connections from the evaluation board, then reconnect and restart.

Note the register contents are updated ONLY when the Read All button is clicked.



The Write Charge Current Button sends only the charge current to the ISL9519. Other registers are unchanged.



The small white window next to “Charge Current” accepts inputs in Amps, and converts them to the hexadecimal (hex) value to be written to the ISL9519 in the grey window. The hex value depends on the value entered in Sense R. The value in the white window will be forced to the nearest valid number that can be produced by the DAC in the ISL9519. That is, after entering 4 and hitting the enter key, the display will change to 3.968. After entering 4.1 and hitting the enter key, the display will change to 4.096. The value can be incremented and decremented with the up/down arrows at the left of the window.



The Sense R inputs are used to calculate the hexadecimal (hex) values and the SMBus sequences for the Charge Current limit and Input Current limit entered in the white boxes. The evaluation board is built with 10mΩ sense resistors. If you change them to another value, enter the new value to get correct calculations.

After entering a number in the white box, hitting the enter key or clicking on another area will enter the value and the resulting hex value and the SMBus sequence will be calculated and displayed.



S = the Start condition, A = the Acknowledge, P = the Stop condition.

Note: The LO byte is sent first. The HI byte is sent second.

When writing 0x41A0, 0xA0 is written first and 0x41 is sent second.

**Important Note: The SMBus commands are NOT sent until one of the WRITE buttons is clicked (i.e., Write All or Write Charge Current).**

**Important Note: Max System Voltage Commands that a much higher than the voltage for the number of cells selected by the CELL pin are ignored (not acknowledged). Please refer to the Max System Voltage section of the data sheet for details.**

The Write MaxSystem Voltage button writes only the MaxSystem Voltage register. Other registers are unchanged.

The small white window accepts Max System Voltage (in Volts) and calculates the hexadecimal value and the SMBus sequence to write to the ISL9519. The SMBus command is sent when the Write MaxSystem Voltage or Write All button is clicked. See Figure 12.

The Write Input Current button writes only the Charge Current register. Other registers are unchanged. The small white window accepts Input Current Limit in Amps and calculates the hex value and the SMBus sequence to be written to the ISL9519. The Sense R input is used to calculate the hex value and the SMBus sequence. The SMBus command is sent when the Write Input Current or Write All button is clicked. See Figure 13.

The ISL9519 will shut down unless it receives MaxSystem Voltage or Charge Current commands every 175s. This is a safety feature that prevents overcharging batteries if bus master has stopped functioning. A toggle switch can be set to tell the software to write all commands every 60 seconds.

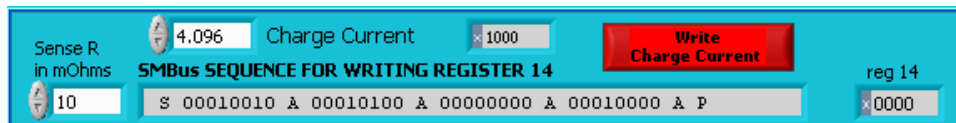
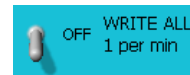

FIGURE 10. WRITE CHARGE CURRENT

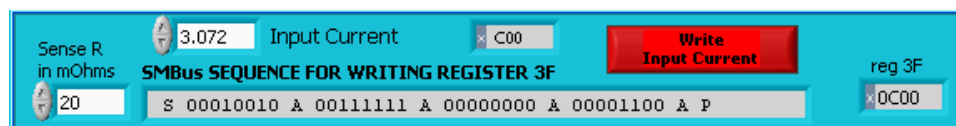

FIGURE 11. WRITE INPUT CURRENT



FIGURE 12. WRITE MAX SYSTEM VOLTAGE



FIGURE 13. WRITE MIN SYSTEM VOLTAGE

### Interface Troubleshooting

When the evaluation board is connected to the PC by a USB cable and communicates with the interface on the eval board, a green check mark will appear next to the USB Interface Status.

If there is a red X instead of the green check, it indicates a problem with communication between the PC and the micro controller on the evaluation board. Check and correct the connection of the USB cable to your PC and the evaluation board. Click on the “RESET INTERFACE” button.

If you still get a red X, close and restart the ISL9519 control software.

If you still get a red X, open the Device Manager (Control Panel/System/Device Manager) with the ISL9519TQFNEVAL2Z evaluation board connected to your USB port. You should see a device named “NI-VISA USB Device”. If it is not in the list of devices, the driver may not be correctly installed. Run the New Hardware wizard.

If you still get a red X, contact an Intersil Field Application Engineer for assistance.

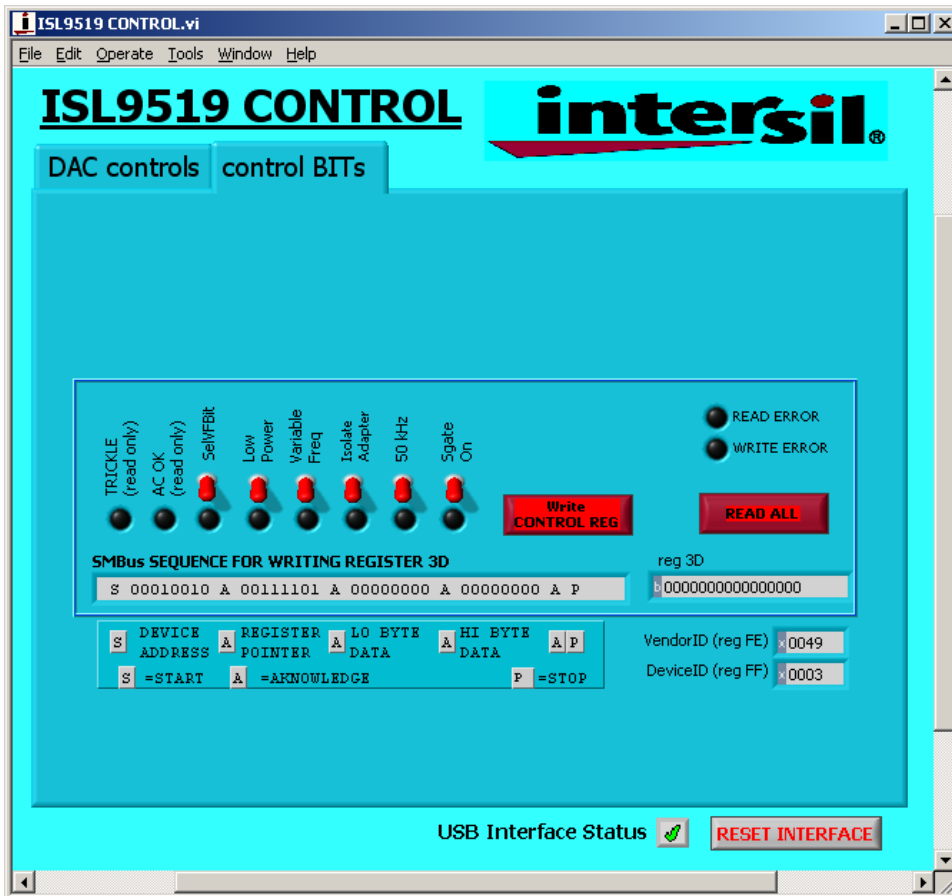

FIGURE 14. WRITE THE CONTROL REGISTER



# ISL9519TQFNEVAL2Z Schematics

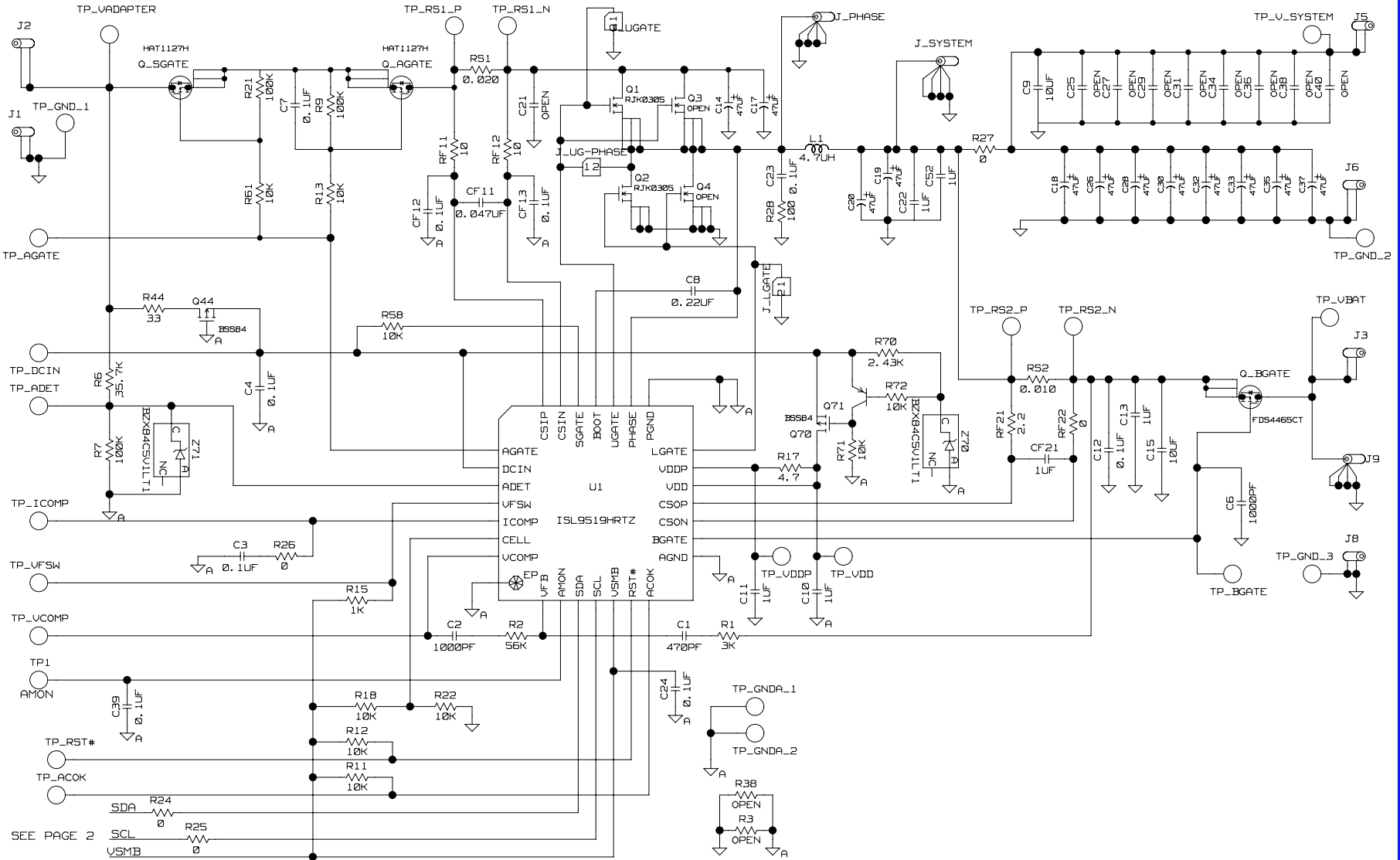
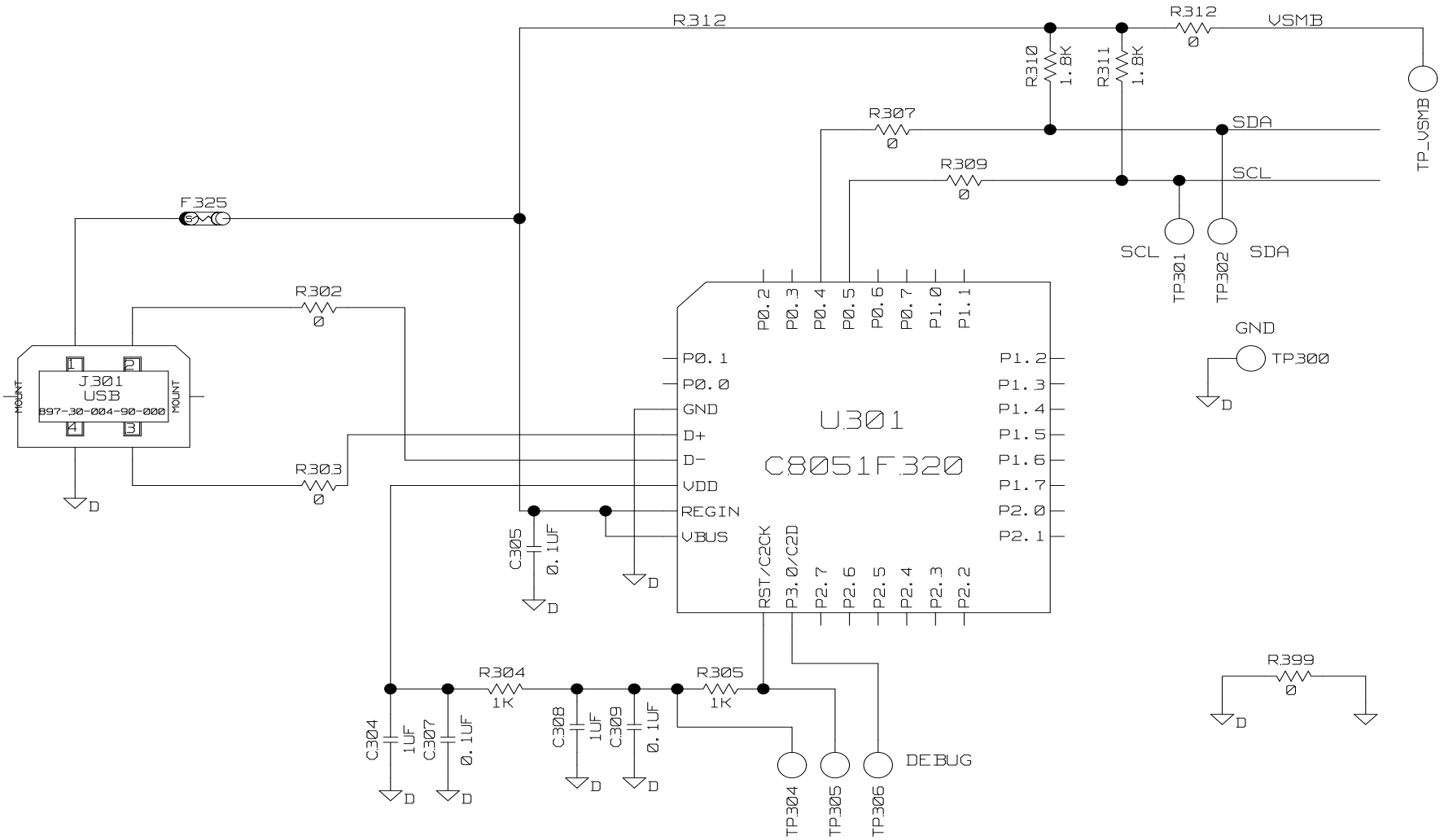

FIGURE 15. ISL9519TQFNEVAL2Z REV C SCHEMATIC

**ISL9519TQFNEVAL2Z Schematics** (Continued)



**FIGURE 16. ISL9519TQFNEVAL2Z REV C SCHEMATIC**

TABLE 1. ISL9519TQFNEVAL2Z REV C EVALUATION BOARD BILL OF MATERIALS

NO.	REF DES	QTY	DESCRIPTION	MANUFACTURER
1	C1	1	CAP, SMD, 0603, 470pF, 25V, 5%, X7R, ROHS	GENERIC
2	C10, C11, C304, C308, CF21	5	CAP, SMD, 0603, 1.0µF, 25V, 10%, X5R, ROHS	GENERIC
3	C13, C22, C52	3	CAP, SMD, 0805, 1.0µF, 25V, 10%, X5R, ROHS	GENERIC
4	C15	1	CAP, SMD, 1206, 10µF, 25V, 10%, X5R, ROHS	GENERIC
5	C9	1	C4532X7R1E106M (C Series Cap)	TDK
6	C2, C6	2	CAP, SMD, 0603, 1000pF, 25V, 5%, X7R, ROHS	GENERIC
7	C3, C4, C7, C12, C23, C24, C39, CF12, CF13, C305, C307, C309	12	CAP, SMD, 0603, 0.1µF, 25V, 10%, X7R	GENERIC
8	C8	1	CAP, SMD, 0603, 0.22µF, 25V, 10%, X7R, ROHS	GENERIC
9	CF11	1	CAP, SMD, 0603, 0.047µF, 25V, 5%, X7R, ROHS	GENERIC
10	Q_BGATE	1	FDS4465SCT	FAIRCHILD
11	Q_AGATE, Q_SGATE	2	HAT1127H	RENESAS
12	R1	1	RES, SMD, 0603, 3k, 1/10W, 1%, TF, ROHS	GENERIC
13	R11, R12, R13, R18, R22, R58, R61, R71, R72	9	RES, SMD, 0603, 10k, 1/10W, 1%, TF, ROHS	GENERIC
14	R15, R304, R305	3	RES, SMD, 0603, 1k, 1/10W, 1%, TF, ROHS	GENERIC
15	R17	1	RES, SMD, 0603, 4.7Ω, 1/10W, 1%, TF, ROHS	GENERIC
16	R2	1	RES, SMD, 0603, 56k, 1/10W, 1%, TF, ROHS	GENERIC
17	R28	1	RES, SMD, 0603, 100Ω, 1/10W, 1%, TF, ROHS	GENERIC
18	R24, R25, R26, RF22, R302, R303, R307, R309, R312, R399	10	RES, SMD, 0603, 0Ω, 1/10W, 1%, TF, ROHS	GENERIC
19	R27	1	RES, SMD, 2010, 0Ω, 1/2W, 5%, TF, ROHS	GENERIC
20	R310, R311	2	RES, SMD, 0603, 1.8k, 1/10W, 1%, TF, ROHS	GENERIC
21	R7, R9, R21	3	RES, SMD, 0603, 100k, 1/10W, 1%, TF, ROHS	GENERIC
22	R44	1	RES, SMD, 0603, 33Ω, 1/10W, 1%, TF, ROHS	GENERIC
23	R6	1	RES, SMD, 0603, 35.7k, 1/10W, 1%, TF, ROHS	GENERIC
24	R70	1	RES, SMD, 0805, 2.43k, 1/10W, 1%, TF, ROHS	GENERIC
25	RF11, RF12	2	RES, SMD, 0603, 10Ω, 1/10W, 1%, TF, ROHS	GENERIC
26	RF21	1	RES, SMD, 0603, 2.2Ω, 1/10W, 1%, TF, ROHS	GENERIC
27	RS1	1	0.02, LRC-LRF2010-01-R020-F	IRC
28	RS2	1	0.01, LRC-LRF2010LF-01-R010-F	IRC
29	U1	1	ISL9519HRTZ	INTERSIL
30	C14, C17, C18, C19, C20, C26, C28, C30, C32, C33, C35, C37	12	20TQC47M, 47µF, TQC Series Hi-Volt Low ESR Capacitor	SANYO
31	F325	1	MICROSMD050F, PolySwitch SM Resetable Fuse	RAYCHEM-TYCO
32	L1	1	IHLP-5050CE-01-4R7M, 4.7µH, 13mm SMD Inductor	VISHAY
33	Q1, Q2	2	RJK0305, N-Channel Power MOSFET	HITACHI
34	Q44, Q70	2	BSS84TA, P-Channel MOSFET	Fairchild
35	Q71	1	MMBT3906, PNP Transistor	Fairchild
36	U301	1	C8051F320-GQ/PROG-REV.02 General Purpose MicroControllers	SILICON LABORATORIES
37	Z70, Z71	2	BZX84C5V1LT1, Zener Diode	Fairchild
38	C21, C25, C27, C29, C31, C34, C36, C38, C40, R3, R38, Q3, Q4	13	OPEN	

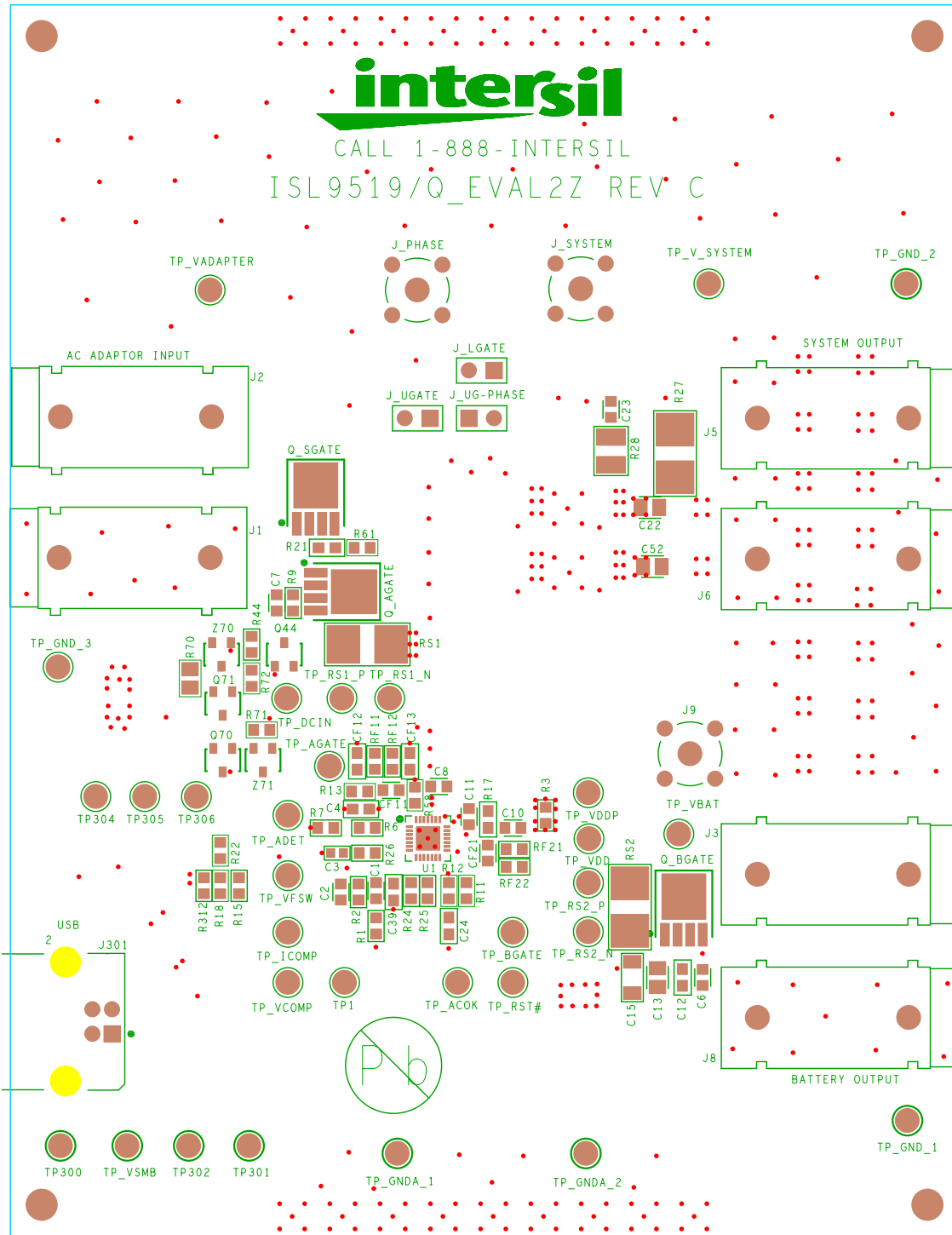

FIGURE 17. TOP SILKSCREEN

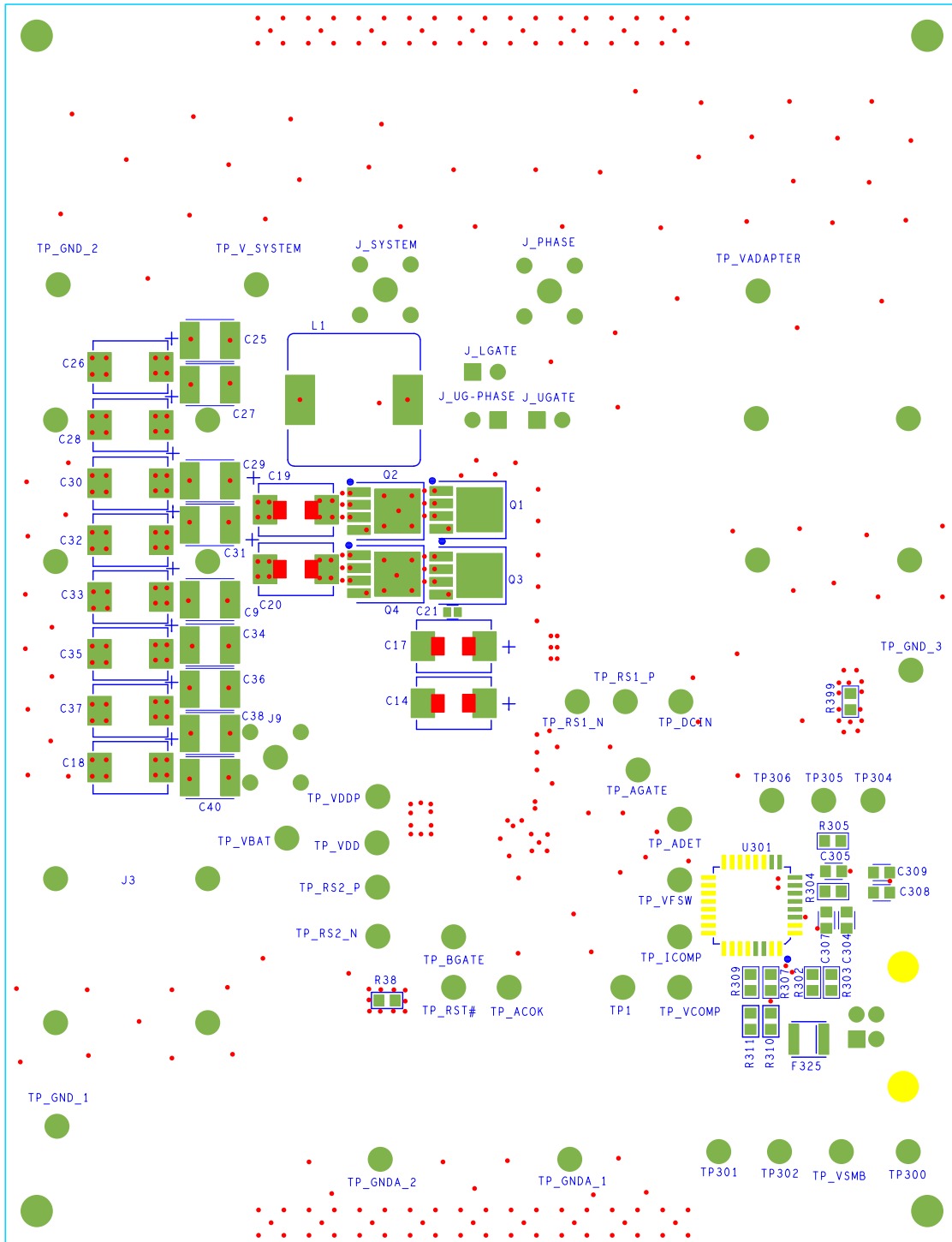

FIGURE 18. BOTTOM SILKSCREEN

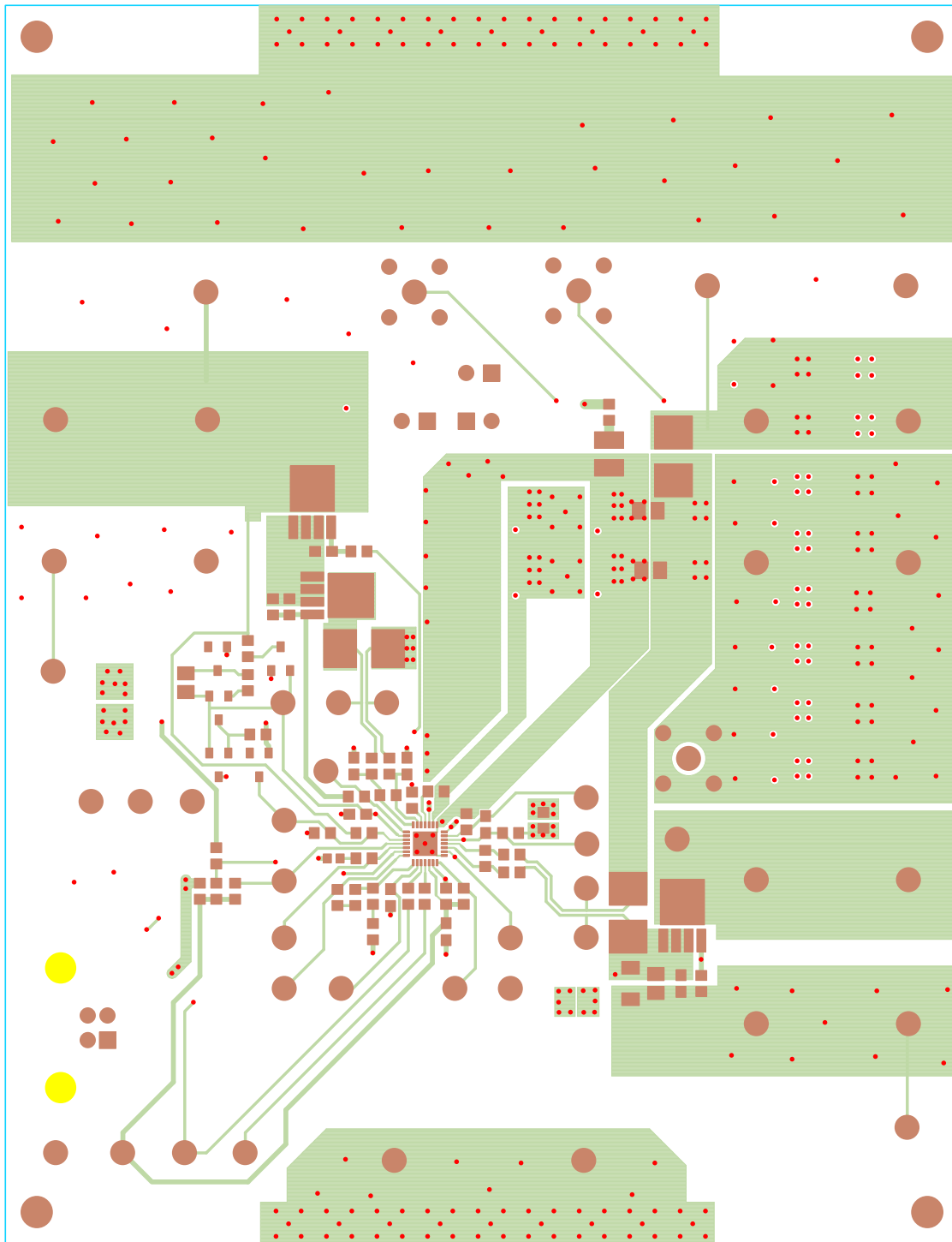

FIGURE 19. TOP LAYER COPPER

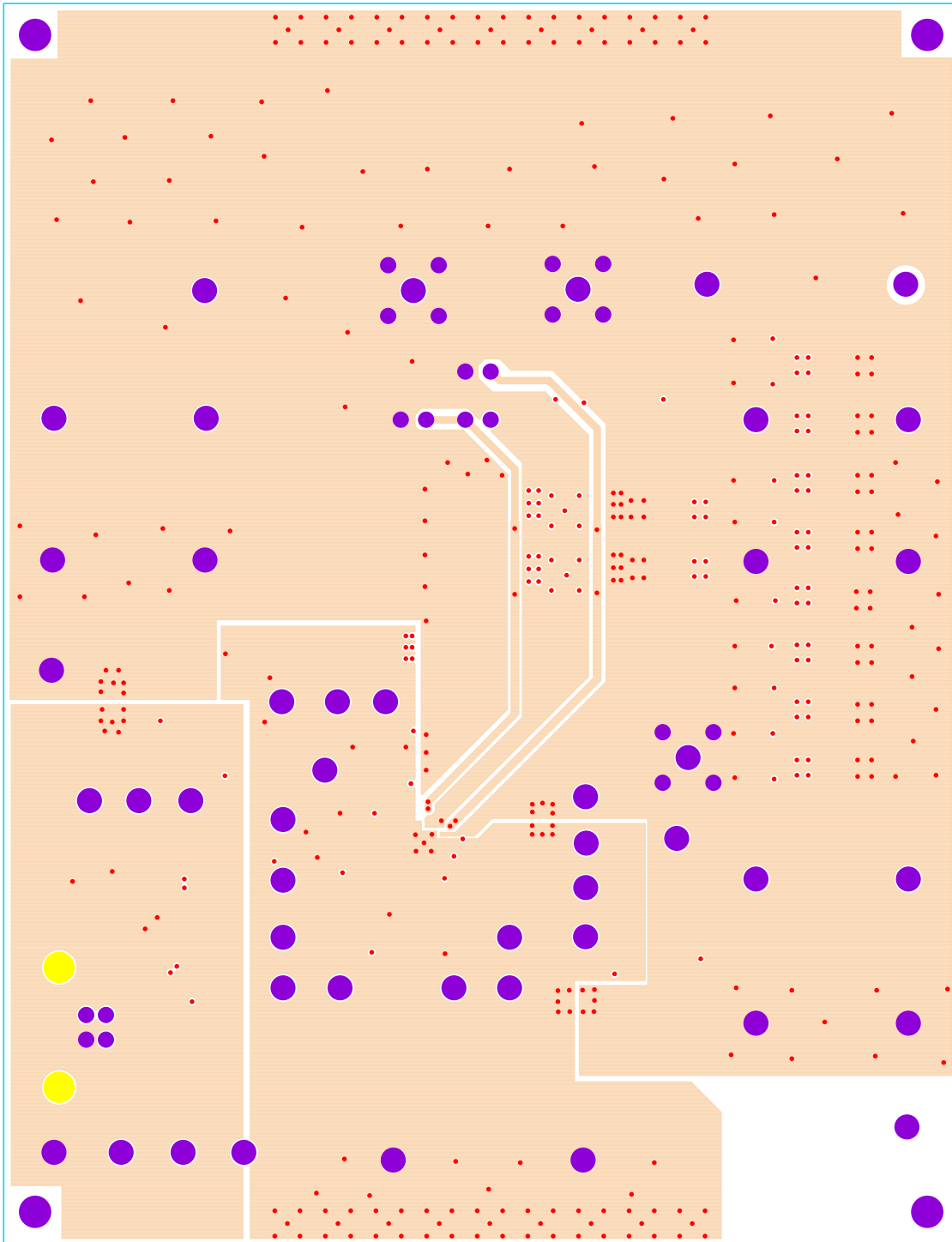

FIGURE 20. LAYER 2 COPPER

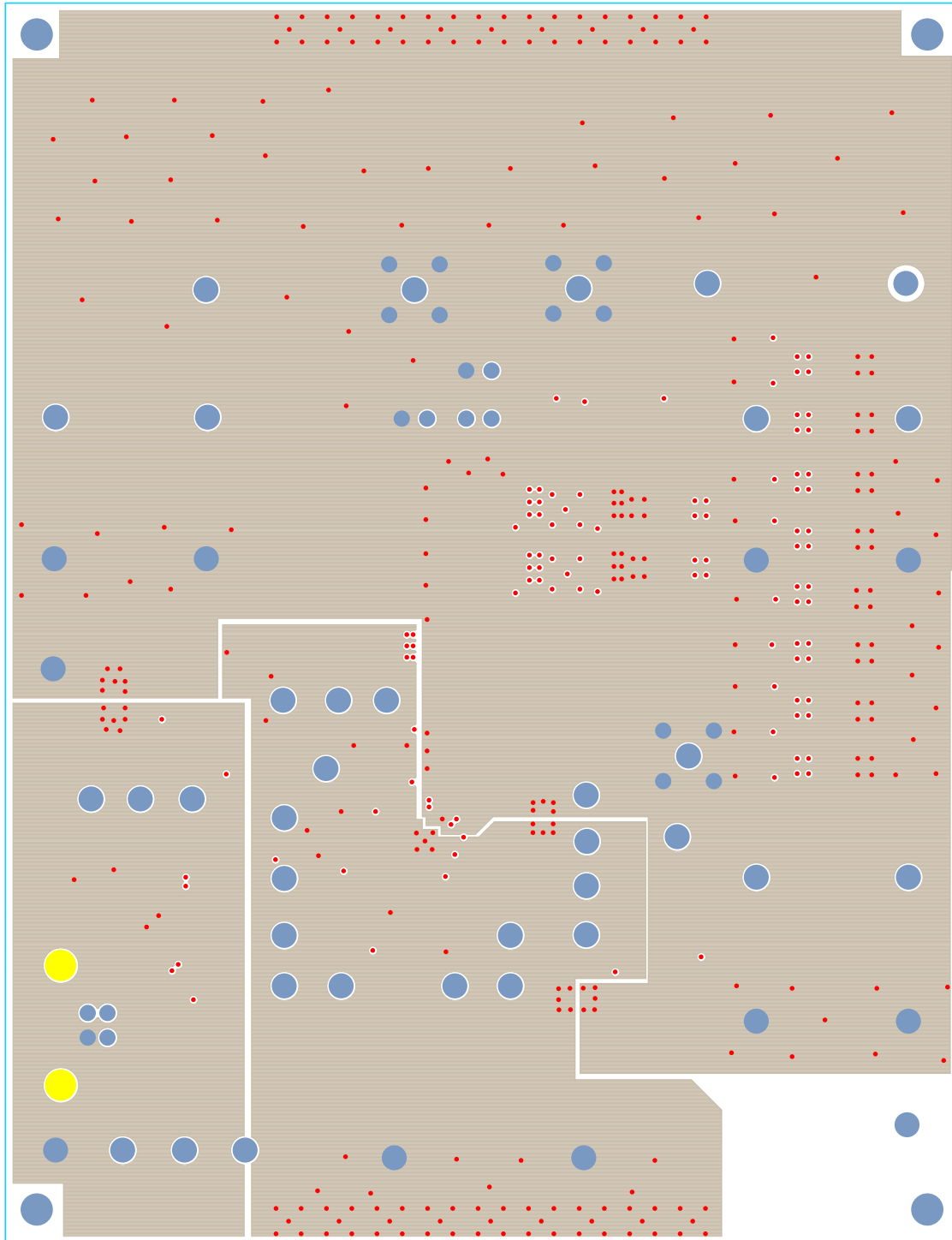

FIGURE 21. LAYER 3 COPPER



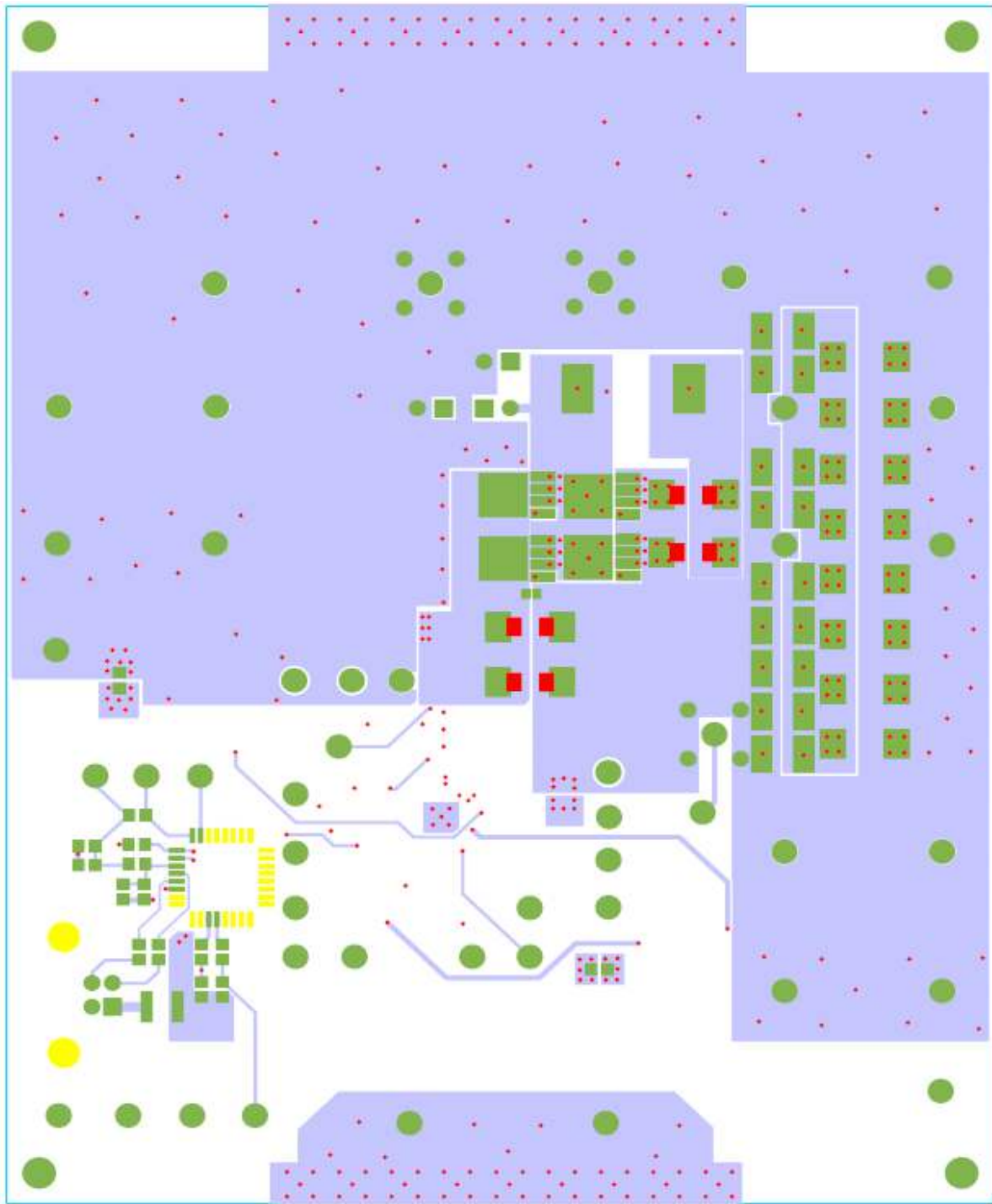

FIGURE 22. BOTTOM LAYER COPPER

## Notice

1. Descriptions of circuits, software and other related information in this document are provided only to illustrate the operation of semiconductor products and application examples. You are fully responsible for the incorporation or any other use of the circuits, software, and information in the design of your product or system. Renesas Electronics disclaims any and all liability for any losses and damages incurred by you or third parties arising from the use of these circuits, software, or information.
2. Renesas Electronics hereby expressly disclaims any warranties against and liability for infringement or any other claims involving patents, copyrights, or other intellectual property rights of third parties, by or arising from the use of Renesas Electronics products or technical information described in this document, including but not limited to, the product data, drawings, charts, programs, algorithms, and application examples.
3. No license, express, implied or otherwise, is granted hereby under any patents, copyrights or other intellectual property rights of Renesas Electronics or others.
4. You shall not alter, modify, copy, or reverse engineer any Renesas Electronics product, whether in whole or in part. Renesas Electronics disclaims any and all liability for any losses or damages incurred by you or third parties arising from such alteration, modification, copying or reverse engineering.
5. Renesas Electronics products are classified according to the following two quality grades: "Standard" and "High Quality". The intended applications for each Renesas Electronics product depends on the product's quality grade, as indicated below.  
"Standard": Computers; office equipment; communications equipment; test and measurement equipment; audio and visual equipment; home electronic appliances; machine tools; personal electronic equipment; industrial robots; etc.  
"High Quality": Transportation equipment (automobiles, trains, ships, etc.); traffic control (traffic lights); large-scale communication equipment; key financial terminal systems; safety control equipment; etc.  
Unless expressly designated as a high reliability product or a product for harsh environments in a Renesas Electronics data sheet or other Renesas Electronics document, Renesas Electronics products are not intended or authorized for use in products or systems that may pose a direct threat to human life or bodily injury (artificial life support devices or systems; surgical implantations; etc.), or may cause serious property damage (space system; undersea repeaters; nuclear power control systems; aircraft control systems; key plant systems; military equipment; etc.). Renesas Electronics disclaims any and all liability for any damages or losses incurred by you or any third parties arising from the use of any Renesas Electronics product that is inconsistent with any Renesas Electronics data sheet, user's manual or other Renesas Electronics document.
6. When using Renesas Electronics products, refer to the latest product information (data sheets, user's manuals, application notes, "General Notes for Handling and Using Semiconductor Devices" in the reliability handbook, etc.), and ensure that usage conditions are within the ranges specified by Renesas Electronics with respect to maximum ratings, operating power supply voltage range, heat dissipation characteristics, installation, etc. Renesas Electronics disclaims any and all liability for any malfunctions, failure or accident arising out of the use of Renesas Electronics products outside of such specified ranges.
7. Although Renesas Electronics endeavors to improve the quality and reliability of Renesas Electronics products, semiconductor products have specific characteristics, such as the occurrence of failure at a certain rate and malfunctions under certain use conditions. Unless designated as a high reliability product or a product for harsh environments in a Renesas Electronics data sheet or other Renesas Electronics document, Renesas Electronics products are not subject to radiation resistance design. You are responsible for implementing safety measures to guard against the possibility of bodily injury, injury or damage caused by fire, and/or danger to the public in the event of a failure or malfunction of Renesas Electronics products, such as safety design for hardware and software, including but not limited to redundancy, fire control and malfunction prevention, appropriate treatment for aging degradation or any other appropriate measures. Because the evaluation of microcomputer software alone is very difficult and impractical, you are responsible for evaluating the safety of the final products or systems manufactured by you.
8. Please contact a Renesas Electronics sales office for details as to environmental matters such as the environmental compatibility of each Renesas Electronics product. You are responsible for carefully and sufficiently investigating applicable laws and regulations that regulate the inclusion or use of controlled substances, including without limitation, the EU RoHS Directive, and using Renesas Electronics products in compliance with all these applicable laws and regulations. Renesas Electronics disclaims any and all liability for damages or losses occurring as a result of your noncompliance with applicable laws and regulations.
9. Renesas Electronics products and technologies shall not be used for or incorporated into any products or systems whose manufacture, use, or sale is prohibited under any applicable domestic or foreign laws or regulations. You shall comply with any applicable export control laws and regulations promulgated and administered by the governments of any countries asserting jurisdiction over the parties or transactions.
10. It is the responsibility of the buyer or distributor of Renesas Electronics products, or any other party who distributes, disposes of, or otherwise sells or transfers the product to a third party, to notify such third party in advance of the contents and conditions set forth in this document.
11. This document shall not be reprinted, reproduced or duplicated in any form, in whole or in part, without prior written consent of Renesas Electronics.
12. Please contact a Renesas Electronics sales office if you have any questions regarding the information contained in this document or Renesas Electronics products.  
(Note 1) "Renesas Electronics" as used in this document means Renesas Electronics Corporation and also includes its directly or indirectly controlled subsidiaries.  
(Note 2) "Renesas Electronics product(s)" means any product developed or manufactured by or for Renesas Electronics.

(Rev.4.0-1 November 2017)



### SALES OFFICES

Renesas Electronics Corporation

<http://www.renesas.com>

Refer to "<http://www.renesas.com/>" for the latest and detailed information.

**Renesas Electronics America Inc.**  
1001 Murphy Ranch Road, Milpitas, CA 95035, U.S.A.  
Tel: +1-408-432-8888, Fax: +1-408-434-5351

**Renesas Electronics Canada Limited**  
9251 Yonge Street, Suite 8309 Richmond Hill, Ontario Canada L4C 9T3  
Tel: +1-905-237-2004

**Renesas Electronics Europe Limited**  
Dukes Meadow, Millboard Road, Bourne End, Buckinghamshire, SL8 5FH, U.K  
Tel: +44-1628-651-700, Fax: +44-1628-651-804

**Renesas Electronics Europe GmbH**  
Arcadiastrasse 10, 40472 Düsseldorf, Germany  
Tel: +49-211-6503-0, Fax: +49-211-6503-1327

**Renesas Electronics (China) Co., Ltd.**  
Room 1709 Quantum Plaza, No.27 ZhichunLu, Haidian District, Beijing, 100191 P. R. China  
Tel: +86-10-8235-1155, Fax: +86-10-8235-7679

**Renesas Electronics (Shanghai) Co., Ltd.**  
Unit 301, Tower A, Central Towers, 555 Langao Road, Putuo District, Shanghai, 200333 P. R. China  
Tel: +86-21-2226-0888, Fax: +86-21-2226-0999

**Renesas Electronics Hong Kong Limited**  
Unit 1601-1611, 16/F., Tower 2, Grand Century Place, 193 Prince Edward Road West, Mongkok, Kowloon, Hong Kong  
Tel: +852-2265-6688, Fax: +852-2886-9022

**Renesas Electronics Taiwan Co., Ltd.**  
13F, No. 363, Fu Shing North Road, Taipei 10543, Taiwan  
Tel: +886-2-8175-9600, Fax: +886-2-8175-9670

**Renesas Electronics Singapore Pte. Ltd.**  
80 Bendemeer Road, Unit #06-02 Hyflux Innovation Centre, Singapore 339949  
Tel: +65-6213-0200, Fax: +65-6213-0300

**Renesas Electronics Malaysia Sdn.Bhd.**  
Unit 1207, Block B, Menara Amcorp, Amcorp Trade Centre, No. 18, Jln Persiaran Barat, 46050 Petaling Jaya, Selangor Darul Ehsan, Malaysia  
Tel: +60-3-7955-9390, Fax: +60-3-7955-9510

**Renesas Electronics India Pvt. Ltd.**  
No.777C, 100 Feet Road, HAL 2nd Stage, Indiranagar, Bangalore 560 038, India  
Tel: +91-80-67208700, Fax: +91-80-67208777

**Renesas Electronics Korea Co., Ltd.**  
17F, KAMCO Yangjae Tower, 262, Gangnam-daero, Gangnam-gu, Seoul, 06265 Korea  
Tel: +82-2-558-3737, Fax: +82-2-558-5338