

EJT1

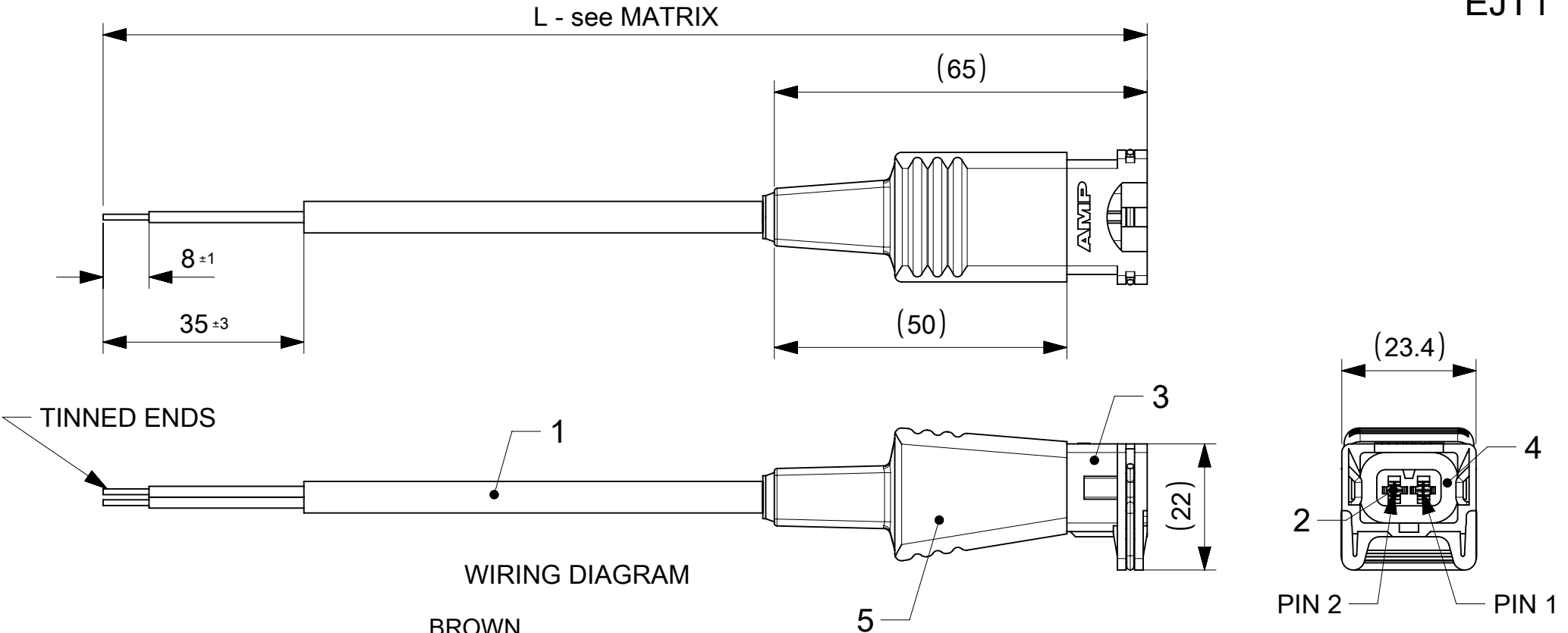

BILL OF MATERIALS

ITEM	QTY.	DESCRIPTION	MATERIAL	FINISH/COLOR
1	-	CABLE	SEE MATRIX	-
2	2	CONTACT FEMALE	PH. BRONZE	-
3	1	HOUSING 2P	PA6.6	BLACK
4	1	GASKET	SILICONE	WHITE
5	-	MOULDING MATERIAL	PP	BLACK

THIS DRAWING CONTAINS INFORMATION THAT IS PROPRIETARY TO MOLEX ELECTRONIC TECHNOLOGIES, LLC AND SHOULD NOT BE USED WITHOUT WRITTEN PERMISSION									
FUNCTIONAL SYMBOLS	DIMENSION UNITS	SCALE	CURRENT REV DESC:						
$\nabla_A = 0$	mm	1:1	EC NO: 681912 DRWN: APAWLAK01 2021/10/12 CHK'D: RSILLER 2021/10/19 APPR: RSILLER 2021/10/19 INITIAL REVISION: DRWN: APAWLAK01 2021/10/12 APPR: RSILLER 2021/10/19						
DIVISIONAL SYMBOLS	GENERAL TOLERANCES (UNLESS SPECIFIED)								
$\nabla_E = 0$	ANGULAR TOL ± °								
$\nabla_P = 0$	4 PLACES ±								
	3 PLACES ±		DOCUMENT NUMBER: 1210460005 DOC TYPE: PSD DOC PART: 000 REVISION: A						
	2 PLACES ±		DRAFT WHERE APPLICABLE MUST REMAIN WITHIN DIMENSIONS THIRD ANGLE PROJECTION DRAWING: A4-SIZE SERIES: 121046 MATERIAL NUMBER: SEE SHEET 2 CUSTOMER: GENERAL MARKET SHEET NUMBER: 1 OF 2						
	1 PLACE ±								
	0 PLACES ±								

molex

JUNIOR TIMER 2P FE STR EJT1XXXXXX

PRODUCT CUSTOMER DRAWING

PART No MATRIX

E J T 1 X X X X X X

JUNIOR CONNECTORS

CONNECTOR TYPE:
1 - 2 WIRES, STRAIGHT

CABLE TYPE:
B3 - PUR BLACK 2x18AWG
N2 - PVC BLACK 2x0.5mm²
N3 - PVC BLACK 2x0.75mm²
P2 - PUR BLACK 2x0.5mm²
P3 - PUR BLACK 2x0.75mm²

HEAD COLOR:
N - BLACK
A - UL BLACK

CABLE LENGTH [cm]
050 = 50cm
300 = 300cm
10K = 1000cm

PART LIST

MOLEX PN	ENGINEERING NO	L±TOL. [mm]
1210460005	EJT1P3N200	2000±30
1210460006	EJT1P3N500	5000±40
1210460008	EJT1P3N300	3000±30
1210460009	EJT1P2N100	1000±20
1210460011	EJT1P3N100	1000±20
1210460012	EJT1P3N800	8000±50
1210460013	EJT1N3N150	1500±30
1210460014	EJT1P2N300	3000±30
1210460015	EJT1P3N150	1500±30
1210460024	EJT1P2N400	4000±40
1210460025	EJT1N3N100	1000±20
1210460026	EJT1P2N600	6000±50
1210460027	EJT1P3N10K	10000±50
1210460028	EJT1N3N200	2000±30
1210460034	EJT1P2N10K	10000±50
1210560056	EJT1N2N300	3000±30
1210560201	EJT1N2N100	1000±20
1210560249	EJT1B3A500	5000±40

TABLE OF LENGHT TOLERANCES

OVER	UP TO AND INCLUDING	TOLERANCE
0	1000	±20
1000	3000	±30
3000	5000	±40
5000	10000	±50
10000	15000	±100
15000	20000	±150
20000		±L/100

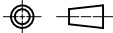
FUNCTIONAL SYMBOLS $\frac{F}{A} = 0$ $\frac{F}{E} = 0$ $\frac{F}{P} = 0$	THIS DRAWING CONTAINS INFORMATION THAT IS PROPRIETARY TO MOLEX ELECTRONIC TECHNOLOGIES, LLC AND SHOULD NOT BE USED WITHOUT WRITTEN PERMISSION		DIMENSION UNITS: mm SCALE: 1:1		CURRENT REV DESC: EC NO: 681912 DRWN: APAWLAK01 2021/10/12 CHK'D: RSILLER 2021/10/19 APPR: RSILLER 2021/10/19	 JUNIOR TIMER 2P FE STR EJT1XXXXXX		
	GENERAL TOLERANCES (UNLESS SPECIFIED) ANGULAR TOL ± °		INITIAL REVISION: DRWN: APAWLAK01 2021/10/12 APPR: RSILLER 2021/10/19					
DIVISIONAL SYMBOLS 4 PLACES ± 3 PLACES ± 2 PLACES ± 1 PLACE ± 0 PLACES ±	DRAFT WHERE APPLICABLE MUST REMAIN WITHIN DIMENSIONS		THIRD ANGLE PROJECTION		DRAWING: A4-SIZE SERIES: 121046		DOCUMENT NUMBER: 1210460005 DOC TYPE: PSD DOC PART: 000 REVISION: A	
					MATERIAL NUMBER: SEE PART LIST CUSTOMER: GENERAL MARKET		SHEET NUMBER: 2 OF 2	

DOCUMENT STATUS | P1 | RELEASE DATE | 2021/10/19 12:55:13

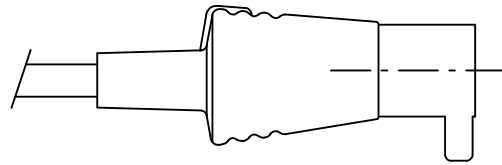

SCHEMAT ELEKTRYCZNY
ELECTRICAL DIAGRAM

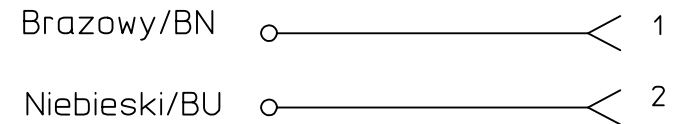
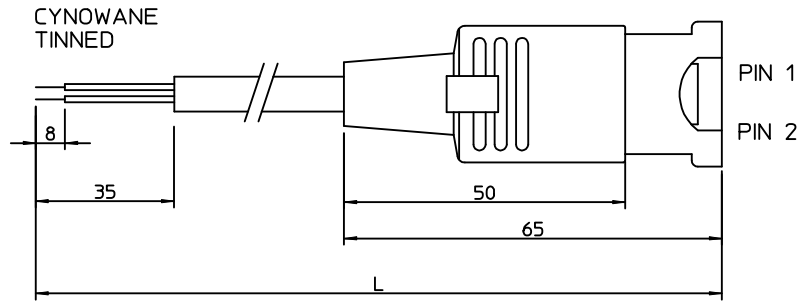
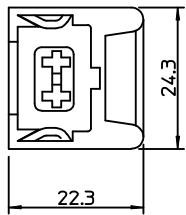

PATRZ UWAGA 1
SEE NOTE 1

UWAGI:

1. DŁUGOSC PATRZ ARKUSZ 2.

NOTES:

1. LENGHT SEE SHEET 2.

ORIGINAL RELEASE	EC NO:	DRWN: MWOLSZCZAK 2009/05/28	QUALITY SYMBOLS	GENERAL TOLERANCES (UNLESS SPECIFIED)		DIMENSION STYLE INCH ONLY		SCALE 1:1	DESIGN UNITS METRIC	FIRST ANGLE PROJECTION	
	REV	CHYKD: MDABROWSKA 2009/06/08	▽=0	mm	INCH	DRAWN BY	DATE	TITLE			
	A	APPR: GOGRODNIK 2009/06/16	∇=0	4 PLACES	± ---	± ---	MLEVYTSKY	2009/04/20	MPM EJ1XXXXXX		
				3 PLACES	± ---	± ---	CHECKED BY	DATE	MATERIAL NO.		
				2 PLACES	± ---	± ---	MDABROWSKA	2009/04/20	DOCUMENT NO.		
				1 PLACE	± ---	± ---	APPROVED BY	DATE	SHEET NO.		
				ANGULAR ± ---°		MWOLSZCZAK 2009/04/20		MOLEX INCORPORATED			
				DRAFT WHERE APPLICABLE MUST REMAIN WITHIN DIMENSIONS		SEE DRAWING		EJ1XXXXXX			
						SIZE A3		THIS DRAWING CONTAINS INFORMATION THAT IS PROPRIETARY TO MOLEX INCORPORATED AND SHOULD NOT BE USED WITHOUT WRITTEN PERMISSION			

PN KEY

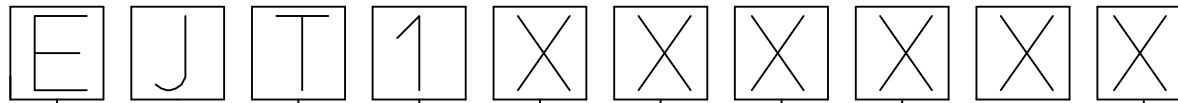

JUNIOR CONNECTORS

CONNECTOR TYPE: _____

1 - 2 WIRES, STRAIGHT

CABLE TYPE, SEE SHEET 2, CHART 1 AND CHART 2 _____

HEAD COLOR: _____

G=GRAY; N=BLACK; T=TRANSPARENT; A=CSA-UL BLACK; B=CSA-UL GRAY

CABLE LENGTH IN CENTIMETRES: _____

EXAMPLE: 050=50 CM, 300=300 CM.

Over	Up to and including	Tolerance
0	1000	±20
1000	3000	±30
3000	5000	±40
5000	10000	±50
10000	15000	±100
15000	20000	±150
20000		±L/100

TABLE 1

MOLEX PN	Engineering No.	L [mm]
1210460005	EJT1P3N200	2000
1210460006	EJT1P3N500	5000
1210460008	EJT1P3N300	3000
1210460009	EJT1P2N100	1000
1210460011	EJT1P3N100	1000
1210460012	EJT1P3N800	8000
1210460013	EJT1N3N150	1500
1210460014	EJT1P2N300	3000
1210460015	EJT1P3N150	1500
1210460024	EJT1P2N400	4000
1210460025	EJT1N3N100	1000
1210460026	EJT1P2N600	6000
1210460027	EJT1P3N10K	10000
1210460028	EJT1N3N200	2000
1210460034	EJT1P2N10K	10000
1210560056	EJT1N2N300	3000
1210560201	EJT1N2N100	1000

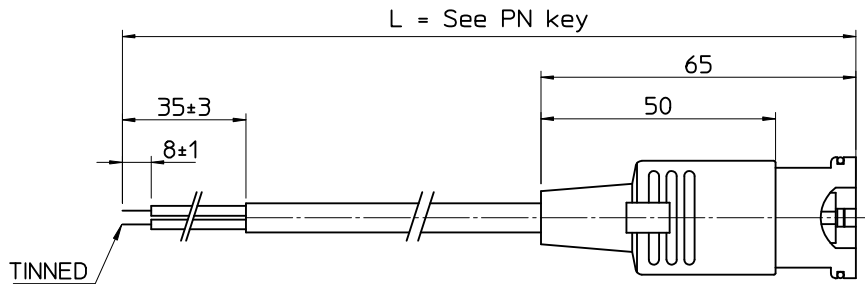

ELECTRICAL DIAGRAM

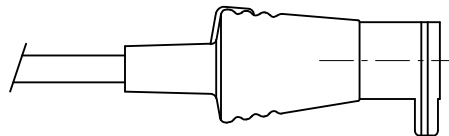
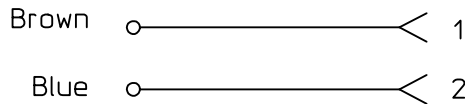

Face View

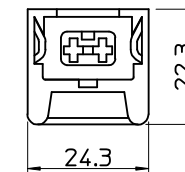

2
1
2
1

NOTES:
1. Dimensions without tolerances are referential

ORIGINAL RELEASE EC NO: IPG2016-0461 DRWN: JMARSZALEK 2014/05/31 CHKD: APPR: MIWASIECZKO 2015/09/28	QUALITY SYMBOLS	GENERAL TOLERANCES (UNLESS SPECIFIED)	DIMENSION STYLE	SCALE	DESIGN UNITS	THIRD ANGLE PROJECTION
	▼=0 ◻=0	mm INCH 4 PLACES ± --- ± --- 3 PLACES ± --- ± --- 2 PLACES ± --- ± --- 1 PLACE ± --- ± --- 0 PLACE ± --- ± ---	MM ONLY	-	METRIC	
	DESCRIPTION	ANGULAR ± --- °	DRAWN BY	DATE	TITLE	
	REV	DRAFT WHERE APPLICABLE MUST REMAIN WITHIN DIMENSIONS	JMARSZALEK	2014/05/31	EJT1XXXXXX JUNIOR TIMER 2P FE STR	
			CHECKED BY	DATE		
			APPROVED BY	DATE		
			MIWASIECZKO	2015/09/28		
			MATERIAL NO.		DOCUMENT NO.	SHEET NO.
			SEE PN KEY		SD-121046-002	1 OF 2
			SIZE	THIS DRAWING CONTAINS INFORMATION THAT IS PROPRIETARY TO MOLEX INCORPORATED AND SHOULD NOT BE USED WITHOUT WRITTEN PERMISSION		
			A3			

TABLE 2 - CABLES

TABLE 2 - CABLES

Molex PN Raw cable	Cable type	Cable code	Wires no.	Cross Section	Jacket material	Jacket color	Diameter Ø [mm]	Wire colors
1210180384	R	3	3	0.75 mm ²	TPR HAL. FREE	Black	6.5±0.2	BN, BU, GN/YE
1210180094	T	3	3	0.75 mm ²	PUR CSA/UL 20668	Yellow	6.5±0.2	BN, BU, GN/YE
1210180309	Y	3	3	0.75 mm ²	SILICONE RUBBER	Red	6.5±0.2	BN, BU, GN/YE
1210180081	F	4	3	1 mm ²	PVC CNOMO	Grey	7.1+0.2/-0	BK1, BK2, GN/YE
1210180042	I	4	2	1 mm ²	PVC CEI 2022 II O.R.	Grey	7.1+0.2/-0	BN, BU
1210180079	I	4	3	1 mm ²	PVC CEI 2022 II O.R.	Grey	7.1+0.2/-0	BN, BU, GN/YE
1210180036	N	4	2	1 mm ²	PVC H05VV-F	Black	6.5±0.2	BN, BU
1210180082	N	4	3	1 mm ²	PVC H05VV-F	Black	6.9±0.2	BN, BU, GN/YE
1210180117	R	4	3	1 mm ²	TPR HAL. FREE	Black	7.1±0.2	BN, BU, GN/YE
1210180085	N	5	3	1.5 mm ²	PVC H05VV-F	Black	7.9±0.2	BN, BU, GN/YE
1210180313	I	6	2	0.35 mm ²	PVC CEI 2011	Grey	4.8±0.2	BN, WH
1210180149	I	9	4	0.75 mm ²	PVC CEI 2022 II	Grey	7.3±0.2	BN, BU, BK, GN/YE

TABLE 1 - TYPES OF CABLES

Code	Cable types	Features	Cross Section
N	PVC	Application general purpose cable which has good resistance to water, but usually poor oil resistance.	0.5 mm ² 0.75 mm ² 1 mm ²
I	CEI	Approved to IEC 332-2A, flame retardant and self extinguishing. Limited resistant to mineral oils.	0.5 mm ² 0.75 mm ² 1 mm ²
P	PUR	Offer good resistance to oil and chemicals. Can swell when constantly immersed in water.	0.5 mm ² 0.75 mm ² 1 mm ²
A	PVC CSA-UL	Approved to CSA-UL 2661, application general purpose cable which has good resistance to water, but usually poor oil resistance.	20 AWG 18 AWG
B	PUR CSA-UL	Approved to CSA-UL 20668, very good resistance to oil and chemicals.	20 AWG 18 AWG

ORIGINAL RELEASE EC NO: IPG2016-0461 DRWN: JMARSZALEK 2014/05/31 CHKD: APPR: MIWASIECZKO 2015/09/28	QUALITY SYMBOLS ▽=0 ◻=0	GENERAL TOLERANCES (UNLESS SPECIFIED)		DIMENSION STYLE MM ONLY		SCALE -	DESIGN UNITS METRIC	THIRD ANGLE PROJECTION				
				mm	INCH	DRAWN BY JMARSZALEK	DATE 2014/05/31	TITLE EJT1XXXXXX JUNIOR TIMER 2P FE STR				
				4 PLACES	± ---	± ---	CHECKED BY	DATE	 SD-121046-002 SHEET NO. 2 OF 2			
				3 PLACES	± ---	± ---	APPROVED BY MIWASIECZKO 2015/09/28					
				2 PLACES	± ---	± ---	MATERIAL NO. SEE PN KEY					
		1 PLACE	± ---	± ---	DRAFT WHERE APPLICABLE MUST REMAIN WITHIN DIMENSIONS							
		0 PLACE	± ---	± ---	SIZE A3 THIS DRAWING CONTAINS INFORMATION THAT IS PROPRIETARY TO MOLEX INCORPORATED AND SHOULD NOT BE USED WITHOUT WRITTEN PERMISSION							