

CD74FCT16652T, CD74FCT162652T

December 1996

Fast CMOS 16-Bit Registered Transceivers

Features

- These Devices are High-speed, Low Power Devices with High Current Drive
- $V_{CC} = 5V \pm 10\%$
- Hysteresis on All Inputs
- CD74FCT16652T
 - High Output Drive: $I_{OH} = -32mA$; $I_{OL} = 64mA$
 - Power Off Disable Outputs Permit "Live Insertion"
 - Typical V_{OLP} (Output Ground Bounce) $< 1.0V$ at $V_{CC} = 5V$, $T_A = 25^\circ C$
- CD74FCT162652T
 - Balanced Output Drivers: $\pm 24mA$
 - Reduced System Switching Noise
 - Typical V_{OLP} (Output Ground Bounce) $< 0.6V$ at $V_{CC} = 5V$, $T_A = 25^\circ C$

Description

Harris' CD74FCT16652T and CD74FCT162652T are produced in an advanced 0.6 micron CMOS technology, achieving industry leading speed grades.

These devices are 16-bit registered transceivers organized as two independent 8-bit bus transceivers designed with three-state D-type flip-flops and control circuitry arranged for multiplexed transmission of data directly from the data bus or from the internal storage registers. Each 8-bit transceiver utilizes the enable controls (χ_{OEAB} and χ_{OEBA}) to control the transceiver functions. The Select (χ_{SAB} and χ_{SBA}) control pins are used to select either real-time or stored data transfer. The circuitry used for select control will eliminate the typical decoding glitch that occurs in a multiplexer during the transition between real-time and stored data. A low input level selects real-time data and a high selects stored data.

The CD74FCT16652T output buffers are designed with a Power-Off disable allowing "live insertion" of boards when used as backplane drivers.

The CD74FCT162652T has $\pm 24mA$ balanced output drivers. It is designed with current limiting resistors at its outputs to control the output edge rate resulting in lower ground bounce and undershoot. This eliminates the need for external terminating resistors for most interface applications.

Pinout

CD74FCT16652T, CD74FCT162652T
(SSOP, TSSOP)
TOP VIEW

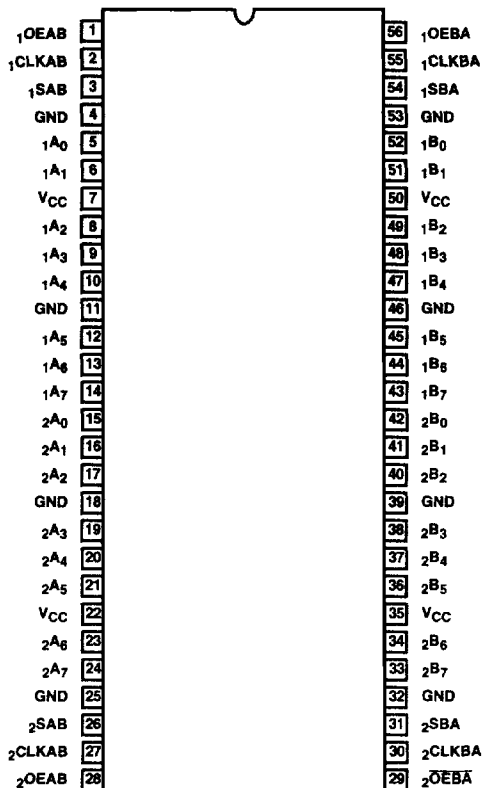

Ordering Information

PART NUMBER	TEMP. RANGE (°C)	PACKAGE	PKG. NO.
CD74FCT16652ATMT	-40 to 85	56 Ld TSSOP	M56.240-P
CD74FCT16652ATSM	-40 to 85	56 Ld SSOP	M56.300-P
CD74FCT16652CTMT	-40 to 85	56 Ld TSSOP	M56.240-P
CD74FCT16652CTSM	-40 to 85	56 Ld SSOP	M56.300-P
CD74FCT16652TMT	-40 to 85	56 Ld TSSOP	M56.240-P
CD74FCT16652TSM	-40 to 85	56 Ld SSOP	M56.300-P
CD74FCT162652ATMT	-40 to 85	56 Ld TSSOP	M56.240-P
CD74FCT162652ATSM	-40 to 85	56 Ld SSOP	M56.300-P
CD74FCT162652CTMT	-40 to 85	56 Ld TSSOP	M56.240-P
CD74FCT162652CTSM	-40 to 85	56 Ld SSOP	M56.300-P
CD74FCT162652DTSM	-40 to 85	56 Ld SSOP	M56.300-P
CD74FCT162652ETSM	-40 to 85	56 Ld TSSOP	M56.240-P
CD74FCT162652TMT	-40 to 85	56 Ld TSSOP	M56.240-P
CD74FCT162652TSM	-40 to 85	56 Ld SSOP	M56.300-P

NOTE: When ordering, use the entire part number. Add the suffix 96 to obtain the variant in the tape and reel.

5
**D.D. 5V FCT BAL.
AND HIGH DRIVE**

Functional Block Diagram

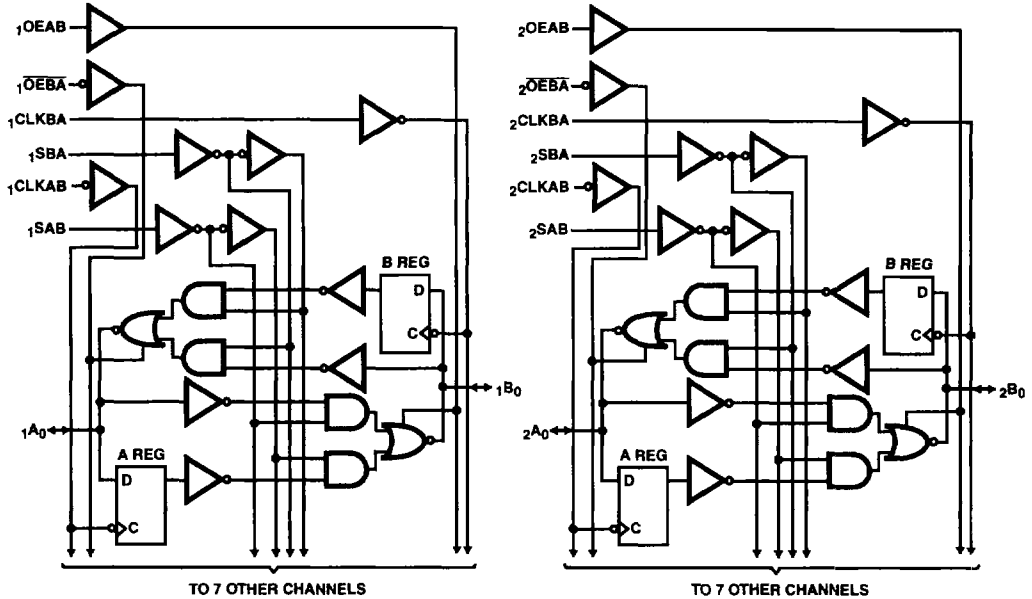

TRUTH TABLE

FUNCTION/OPERATION	INPUTS						DATA I/O	
	xOEAB	xOEBA	xCLKAB	xCLKBA	xSAB	xSBA	xAx	xBx
Isolation	L	H	H or L	H or L	X	X	Input	Input
Store A and B Data	L	H	↑	↑	X	X	Input	Input
Store A, Hold B	X	H	↑	H or L	X	X	Input	Unspecified (Note 1)
Store A in Both Registers	H	H	↑	↑	X (Note 2)	X	Input	Output
Hold A, Store B	L	X	H or L	↑	X	X	Unspecified (Note 1)	Input
Store B in Both Registers	L	L	↑	↑	X	X (Note 2)	Output	Input
Real Time B Data to A Bus	L	L	X	X	X	L	Output	Input
Stored B Data to A Bus	L	L	X	H or L	X	H	Output	Input
Real Time A Data to B Bus	H	H	X	X	L	X	Input	Output
Stored A Data to B Bus	H	H	H or L	X	H	X	Input	Output
Stored A Data to B Bus and Stored B Data to A Bus	H	L	H or L	H or L	H	H	Output	Output

NOTES:

- The data output functions may be enabled or disabled by various signals at the xOEAB or xOEBA inputs. Data input functions are always enabled, i.e., data at the bus pins will be stored on every low-to-high transition on the clock inputs.
- Select control = L: clocks can occur simultaneously.
Select control = H: clocks must be staggered in order to load both registers.
H = High Voltage Level
L = Low Voltage Level
X = Don't Care
↑ = LOW-to-HIGH transition

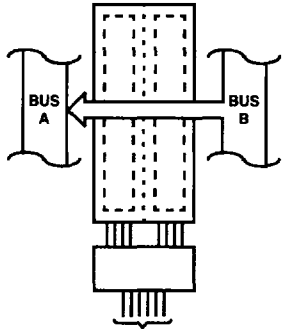

\overline{xOEAB} \overline{xOEBA} $xCLKAB$ $xCLKBA$ $xSAB$ $xSBA$
L L X X X L

FIGURE 1. REAL-TIME TRANSFER BUS B TO A

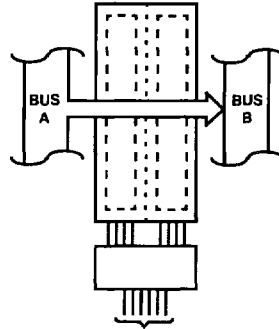

\overline{xOEAB} \overline{xOEBA} $xCLKAB$ $xCLKBA$ $xSAB$ $xSBA$
H H X X L X

FIGURE 2. REAL-TIME TRANSFER BUS A TO B

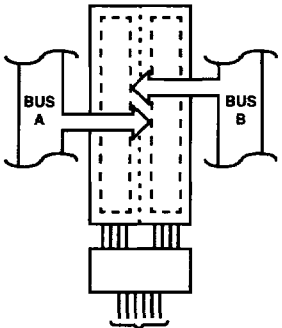

\overline{xOEAB} \overline{xOEBA} $xCLKAB$ $xCLKBA$ $xSAB$ $xSBA$
X H ↑ X X X
L X X ↑ X X
L H ↑ ↑ X X

FIGURE 3. STORAGE FROM A AND/OR B

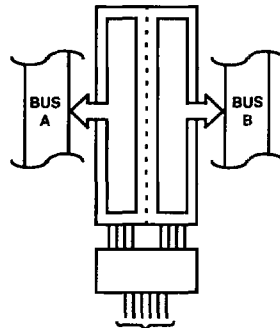

\overline{xOEAB} \overline{xOEBA} $xCLKAB$ $xCLKBA$ $xSAB$ $xSBA$
H L H or L H or L H H

FIGURE 4. TRANSFER STORES DATA TO A AND/OR B

5

D.D. 5V FCT BAL.
AND HIGH DRIVE

Pin Descriptions

PIN NAME	DESCRIPTION
x^A_x	Data Register A Inputs Data Register B Outputs
x^B_x	Data Register B Inputs Data Register A Outputs
$xCLKAB, xCLKBA$	Clock Pulse Inputs
SAB, SBA	Output Data Source Select Inputs
$\overline{xOEAB}, \overline{xOEBA}$	Output Enable Inputs
GND	Ground
V_{CC}	Power

CD74FCT16652T, CD74FCT162652T

Absolute Maximum Ratings

DC Input Voltage -0.5V to 7.0V
 DC Output Current 120mA

Operating Conditions

Operating Temperature Range -40°C to 85°C
 Supply Voltage to Ground Potential
 Inputs and V_{CC} Only -0.5V to 7.0V
 Supply Voltage to Ground Potential
 Outputs and D/O Only -0.5V to 7.0V

Thermal Information

Thermal Resistance (Typical, Note 3) θ_{JA} (°C/W)
 TSSOP Package 35
 SSOP Package 70
 Maximum Junction Temperature 150°C
 Maximum Storage Temperature Range -65°C to 150°C
 Maximum Lead Temperature (Soldering 10s) 300°C
 (Lead Tips Only)

CAUTION: Stresses above those listed in "Absolute Maximum Ratings" may cause permanent damage to the device. This is a stress only rating and operation of the device at these or any other conditions above those indicated in the operational sections of this specification is not implied.

NOTE:

3. θ_{JA} is measured with the component mounted on an evaluation PC board in free air.

Electrical Specifications

PARAMETER	SYMBOL	(NOTE 4) TEST CONDITIONS	MIN	(NOTE 5) TYP	MAX	UNITS	
DC ELECTRICAL SPECIFICATIONS Over the Operating Range, T _A = -40°C to 85°C, V _{CC} = 5.0V ±10%							
Input HIGH Voltage	V _{IH}	Guaranteed Logic HIGH Level	2.0	-	-	V	
Input LOW Voltage	V _{IL}	Guaranteed Logic LOW Level	-	-	0.8	V	
Input HIGH Current	I _{IH}	V _{CC} = Max V _{IN} = V _{CC}	-	-	1	μA	
Input LOW Current	I _{IL}	V _{CC} = Max V _{IN} = GND	-	-	-1	μA	
High Impedance Output Current	I _{OZH}	V _{CC} = Max V _{OUT} = 2.7V	-	-	1	μA	
	I _{OZL}	V _{CC} = Max V _{OUT} = 0.5V	-	-	-1	μA	
Clamp Diode Voltage	V _{IK}	V _{CC} = Min, I _{IN} = -18mA	-	-0.7	-1.2	V	
Short Circuit Current	I _{OS}	V _{CC} = Max (Note 6), V _{OUT} = GND	-80	-140	-200	mA	
Output Drive Current	I _O	V _{CC} = Max (Note 6), V _{OUT} = 2.5	-50	-	-180	mA	
Input Hysteresis	V _H		-	100	-	mV	
CD74FCT16652T OUTPUT DRIVE SPECIFICATIONS Over the Operating Range, T _A = -40°C to 85°C, V _{CC} = 5.0V ±10%							
Output HIGH Voltage	V _{OH}	V _{CC} = Min, V _{IN} = V _{IH} or V _{IL}	I _{OH} = -3.0mA	2.5	3.5	-	V
			I _{OH} = -15.0mA	2.4	3.5	-	V
			I _{OH} = -32.0mA	2.0	3.0	-	V
Output LOW Voltage	V _{OL}	V _{CC} = Min, V _{IN} = V _{IH} or V _{IL}	I _{OL} = 64mA	-	0.2	0.55	V
Power Down Disable	I _{OFF}	V _{CC} = 0V, V _{IN} or V _{OUT} ≤ 4.5V	-	-	±100	μA	
CD74FCT162652T OUTPUT DRIVE SPECIFICATIONS Over the Operating Range, T _A = -40°C to 85°C, V _{CC} = 5.0V ±10%							
Output HIGH Voltage	V _{OH}	V _{CC} = Min, V _{IN} = V _{IH} or V _{IL}	I _{OH} = -24.0mA	2.4	3.3	-	V
Output LOW Voltage	V _{OL}	V _{CC} = Min, V _{IN} = V _{IH} or V _{IL}	I _{OL} = 24mA	-	0.3	0.55	V
Output LOW Current	I _{ODL}	V _{CC} = 5V, V _{IN} = V _{IH} or V _{IL} , V _{OUT} = 1.5V (Note 6)	60	115	150	mA	
Output HIGH Current	I _{ODH}	V _{CC} = 5V, V _{IN} = V _{IH} or V _{IL} , V _{OUT} = 1.5V (Note 6)	-60	-115	-150	mA	

Electrical Specifications (Continued)

PARAMETER	SYMBOL	(NOTE 4) TEST CONDITIONS	MIN	(NOTE 5) TYP	MAX	UNITS	
CAPACITANCE $T_A = 25^\circ\text{C}$, $f = 1\text{MHz}$							
Input Capacitance (Note 7)	C_{IN}	$V_{IN} = 0V$	-	4.5	6	pF	
Output Capacitance (Note 7)	C_{OUT}	$V_{OUT} = 0V$	-	5.5	8	pF	
POWER SUPPLY SPECIFICATIONS							
Quiescent Power Supply Current	I_{CC}	$V_{CC} = \text{Max}$	$V_{IN} = \text{GND}$ or V_{CC}	-	0.1	500	μA
Supply Current per Input at TTL HIGH	ΔI_{CC}	$V_{CC} = \text{Max}$	$V_{IN} = 3.4V$ (Note 8)	-	0.5	1.5	mA
Supply Current per Input per MHz (Note 9)	I_{CCD}	$V_{CC} = \text{Max}$, Outputs Open $\overline{xOEAB} = \overline{xOEBA} = \text{GND}$ One Bit Toggling 50% Duty Cycle	$V_{IN} = V_{CC}$ $V_{IN} = \text{GND}$	-	75	120	$\mu\text{A}/\text{MHz}$
Total Power Supply Current (Note 11)	I_C	$V_{CC} = \text{Max}$, Outputs Open $f_{CP} = 10\text{MHz}$ (\overline{xCLKBA}) 50% Duty Cycle $\overline{xOEAB} = \overline{xOEBA} = \text{GND}$ One Bit Toggling $f_1 = 5\text{MHz}$, 50% Duty Cycle	$V_{IN} = V_{CC}$ $V_{IN} = \text{GND}$	-	0.8	1.7 (Note 10)	mA
			$V_{IN} = 3.4V$ $V_{IN} = \text{GND}$	-	1.3	3.2 (Note 10)	mA
		$V_{CC} = \text{Max}$, Outputs Open $f_{CP} = 10\text{MHz}$ (\overline{xCLKBA}) 50% Duty Cycle $\overline{xOEAB} = \overline{xOEBA} = \text{GND}$ 16 Bits Toggling $f_1 = 2.5\text{MHz}$, 50% Duty Cycle	$V_{IN} = V_{CC}$ $V_{IN} = \text{GND}$	-	3.8	6.5 (Note 10)	mA
			$V_{IN} = 3.4V$ $V_{IN} = \text{GND}$	-	8.3	22.0 (Note 10)	mA

5

D.D. 5V FCT BAL.
AND HIGH DRIVE

CD74FCT16652T, CD74FCT162652T

Switching Specifications Over Operating Range

PARAMETER	SYMBOL	(NOTE 12) TEST CONDITIONS	T		AT		CT		DT		UNITS
			(NOTE 13) MIN	MAX	(NOTE 13) MIN	MAX	(NOTE 13) MIN	MAX	(NOTE 13) MIN	MAX	
Propagation Delay Bus to Bus	t _{PLH} , t _{PHL}	C _L = 50pF R _L = 500Ω	2.0	9.0	2.0	6.3	1.5	5.4	1.5	4.4	ns
Output Enable Time xOEAB or xOEBA to Bus	tpZH, tpZL		2.0	14.0	2.0	9.8	1.5	7.8	1.5	5.0	ns
Output Disable Time (Note 14) xOEAB or xOEBA to Bus	tpHZ, tpLZ		2.0	9.0	2.0	6.3	1.5	6.3	1.5	4.3	ns
Propagation Delay Clock to Bus	t _{PLH} , t _{PHL}		2.0	9.0	2.0	6.3	1.5	5.7	1.5	4.4	ns
Propagation Delay xSBA or xSAB to Bus	t _{PLH} , t _{PHL}		2.0	11.0	2.0	7.7	1.5	6.2	1.5	5.0	ns
Setup Time HIGH or LOW, Bus to Clock	t _{SU}		4.0	-	2.0	-	2.0	-	2.0	-	ns
Hold Time HIGH or LOW, Bus to Clock	t _H		2.0	-	1.5	-	1.5	-	1.0	-	ns
Clock Pulse Width HIGH or LOW (Note 14)	t _W		6.0	-	5.0	-	5.0	-	3.0	-	ns
Output Skew (Note 15)	t _{SK(O)}		-	0.5	-	0.5	-	0.5	-	0.5	ns

NOTES:

4. For conditions shown as Max or Min, use appropriate value specified under Electrical Specifications for the applicable device type.
5. Typical values are at V_{CC} = 5.0V, 25°C ambient and maximum loading.
6. Not more than one output should be shorted at one time. Duration of the test should not exceed one second.
7. This parameter is determined by device characterization but is not production tested.
8. Per TTL driven input (V_{IN} = 3.4V); all other inputs at V_{CC} or GND.
9. This parameter is not directly testable, but is derived for use in Total Power Supply Calculations.
10. Values for these conditions are examples of the I_{CC} formula. These limits are guaranteed but not tested.
11. I_C = I_{QUIESCENT} + I_{INPUTS} + I_{DYNAMIC}
 $I_C = I_{CC} + \Delta I_{CC} D_H N_T + I_{CCD} (f_{CP}/2 + f_i N_i)$
 I_{CC} = Quiescent Current
 ΔI_{CC} = Power Supply Current for a TTL High Input (V_{IN} = 3.4V)
 D_H = Duty Cycle for TTL Inputs High
 N_T = Number of TTL Inputs at D_H
 I_{CCD} = Dynamic Current Caused by an Input Transition Pair (HLH or LHL)
 f_{CP} = Clock Frequency for Register Devices (Zero for Non-Register Devices)
 f_i = Input Frequency
 N_i = Number of Inputs at f_i
 All currents are in milliamps and all frequencies are in megahertz.
12. See test circuit and wave forms.
13. Minimum limits are guaranteed but not tested on Propagation Delays.
14. This parameter is guaranteed but not production tested.
15. Skew between any two outputs, of the same package, switching in the same direction. This parameter is guaranteed by design.

Test Circuits and Waveforms

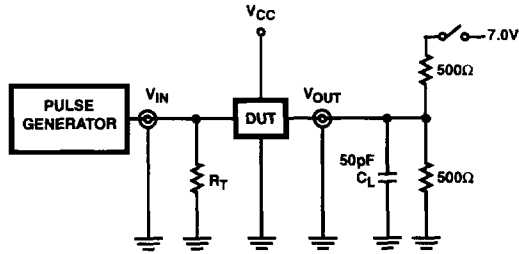

NOTE:

16. Pulse Generator for All Pulses: Rate $\leq 1.0\text{MHz}$; $Z_{OUT} \leq 50\Omega$;
 $t_r, t_f \leq 2.5\text{ns}$.

FIGURE 5. TEST CIRCUIT

SWITCH POSITION	
TEST	SWITCH
t_{PLZ}, t_{PZL}	Closed
$t_{PHZ}, t_{PZH}, t_{PLH}, t_{PHL}$	Open

DEFINITIONS:

C_L = Load capacitance, includes jig and probe capacitance.

R_T = Termination resistance, should be equal to Z_{OUT} of the Pulse Generator.

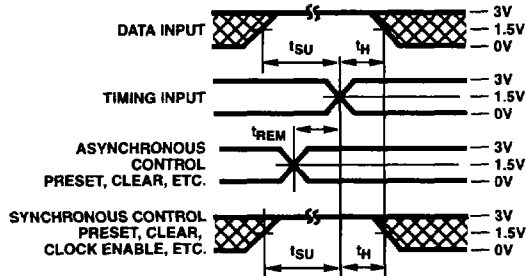

FIGURE 6. SETUP, HOLD, AND RELEASE TIMING

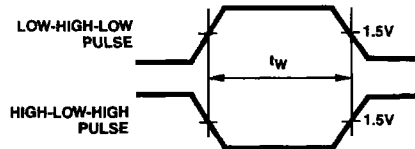

FIGURE 7. PULSE WIDTH

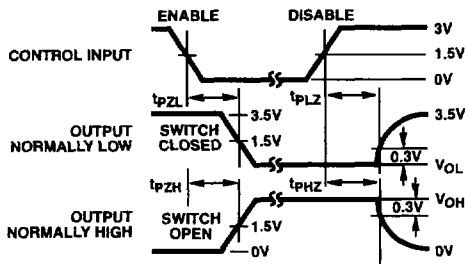

FIGURE 8. ENABLE AND DISABLE TIMING

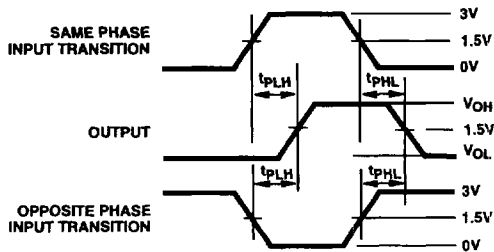

FIGURE 9. PROPAGATION DELAY

5
 D.D. 5V FCT BAL.
 AND HIGH DRIVE