

Using the TPS92210EVM-613

User's Guide



Literature Number: SLUU436A
August 2010—Revised November 2010

Natural PFC LED Lighting Driver Controller

1 Introduction

The TPS92210EVM-613 evaluation module is a constant current TRIAC dimmable LED driver. It can drive 9 to 10 LEDs at 350 mA and is rated for an AC input of 184 V_{RMS} to 265 V_{RMS}.

2 Description

The TPS92210EVM-613 uses the TPS92210 in a Discontinuous Conduction Mode (DCM) flyback topology. The controller uses cascode configuration which allows for faster start-up times as well as eliminates the need for an external sense resistor for primary-side current sense. Additionally, the controller employs a max on-time modulation scheme that allows it to be used in a Power Factor Correction (PFC) circuit. This results in a compact LED driver design that achieves greater than 0.95 power factor (PF) driven by a single controller.

The TPS92210EVM-613 is also compatible with a wide variety of TRIAC dimmers. Secondary-side feedback responds to the conduction time of the sinusoidal wave, as governed by the TRIAC, and appropriately lowers the LED current to dim the LEDs. The secondary side also includes an adaptive supplemental load that sinks current when LED current becomes too low, therefore ensuring conduction of the TRIAC during very low dimming.

2.1 Typical Applications

- Commercial/Household LED Lighting

2.2 Features

- Single Stage Power Factor Correction Achieves PF Greater than 0.95
- TRIAC Dimming to Zero LED Current
- Test Points for Output Voltage/Current
- Cascoded Configuration for Fully Integrated Current Control with No External Sense Resistor

3 Electrical Performance Specifications

Table 1. Electrical Performance Specifications

PARAMETER	TEST CONDITIONS	MIN	TYP	MAX	UNITS
Input Characteristics					
Voltage range		184		265	V_{AC}
Maximum input current			45		mA
Output Characteristics					
Output voltage, V _{OUT}		19		32	V
Output load current, I _{OUT}		330	350	370	mA
Output current ripple	At $V_{IN} = 230 V_{AC}$		127		mApp
Output over voltage			36		V
Systems Characteristics					
Switching frequency			~115		kHz
Peak efficiency			87.3%		
Full load efficiency	$V_{IN} = 230 V_{AC}$		87%		
Power Factor			> 0.95		

4 Schematic

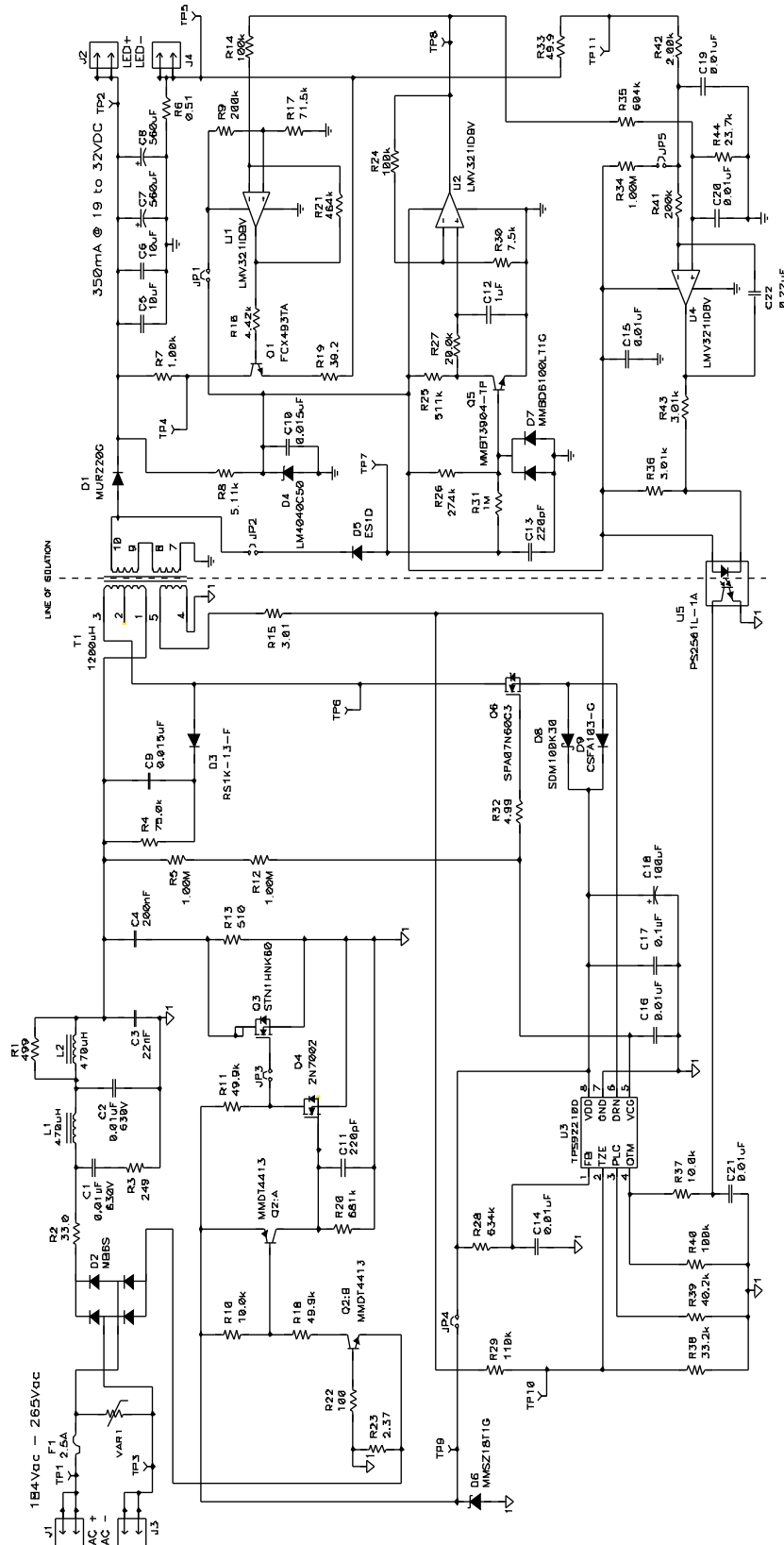

Figure 1. Schematic

5 Test Setup

5.1 Test Equipment

Voltage Source: 265- V_{RMS} AC source capable of at least 12 W

Multimeters: 4 Voltmeters

Network Analyzer: To measure loop response (phase/magnitude measurements)

Output Load: 9 LEDs in series ($V_F = 3.5\text{ V}$ at 350 mA per LED) or 80- Ω , 12-W resistor

Oscilloscope: 4 channel 100 MHz, high voltage probe rated for at least 600 V

Recommended Wire Gauge: 18 AWG

5.2 Recommended Test Setup

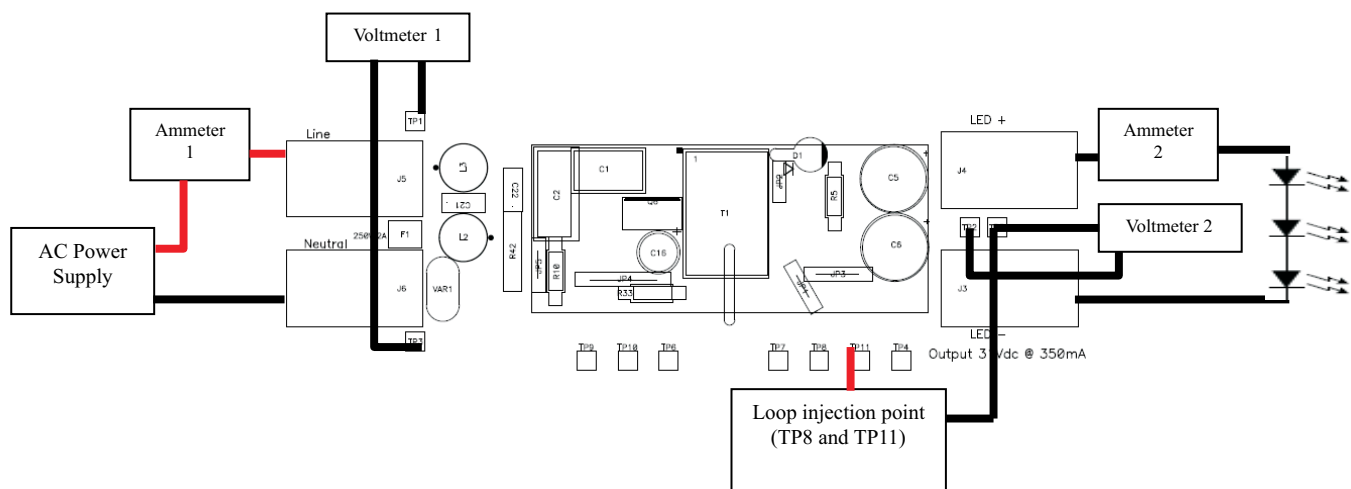

Figure 2. Recommended Test Setup

5.3 List of Test Points

Table 2. Test Points Functions

TEST POINTS	NAME	DESCRIPTION
TP1	Input AC +	AC line input
TP2	LED +	LED output
TP3	Input AC -	AC line input
TP4	Dummy load	Dummy load test point
TP5	LED -	LED return point
TP6	Switch node	Flyback switch node
TP7	N/A	Recreated primary side sinusoidal voltage
TP8	TRIAC conduction angle	Scaled TRIAC conduction angle
TP9	VDD	VDD of TPS92210
TP10	TZE	Transformer Zero Energy detection
TP11	Loop response	Loop injection point for phase/gain measurement

6 Test Procedure

CAUTION

CAUTION: High voltages exist on this EVM. Please handle with care. Do not touch EVM when powered.

An external load MUST be used to power up this EVM. No load on the output will trigger the over-voltage protection and shut down the EVM.

6.1 Line Regulation and Efficiency Measurement Procedure

1. Connect EVM per [Figure 2](#) above. An external LED load must be used to start up the EVM.

NOTE: Frequency analyzer not required for this procedure.

2. Set AC source to 184 V_{RMS} .
3. Turn on AC source.
4. Record output voltage reading from Voltmeter 2 and output current reading from Ammeter 2 and input voltage reading from Voltmeter 1 and Ammeter 1.
5. Increase output voltage by 5 V_{RMS} .
6. Repeat steps 4 and 5 until you reach 265 V_{RMS} .
7. Turn off the AC source.

6.2 TRIAC Dimmer Measurement Procedure

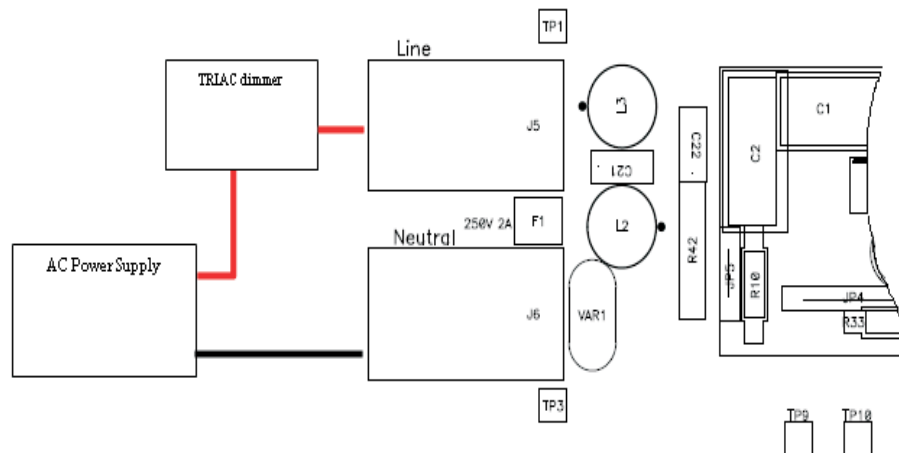

Figure 3. TRIAC Dimmer Test Setup

1. Set up the EVM per [Figure 2](#).
2. Add TRIAC dimmer to the input per [Figure 3](#).
3. Set AC source to 230 V_{RMS} (or 220 V_{RMS} depending on the TRIAC).
4. Set line frequency to 50 Hz.
5. Set TRIAC to maximum output.
6. Measure output current.
7. Slowly slide TRIAC dimmer to minimum output.
8. Observe output current reduces.

6.3 Equipment Shutdown

1. Turn off the AC source.

7 Performance Data and Typical Characteristic Curves

Figure 4 through Figure 15 present typical performance curves for TPS92210EVM-613.

7.1 Efficiency

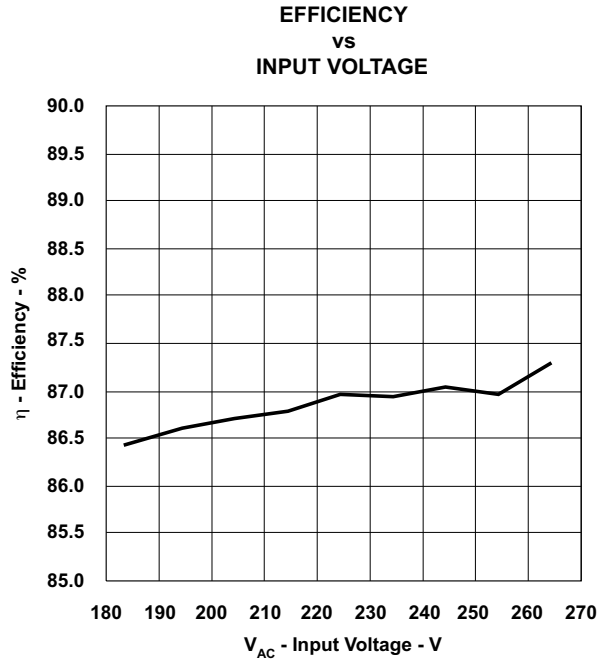

Figure 4. Efficiency

7.2 Line Regulation

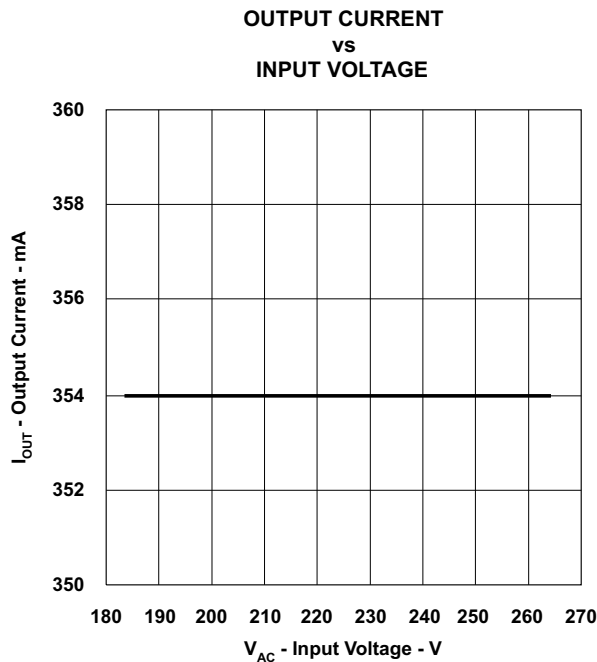

Figure 5. Line Regulation

7.3 Power Factor

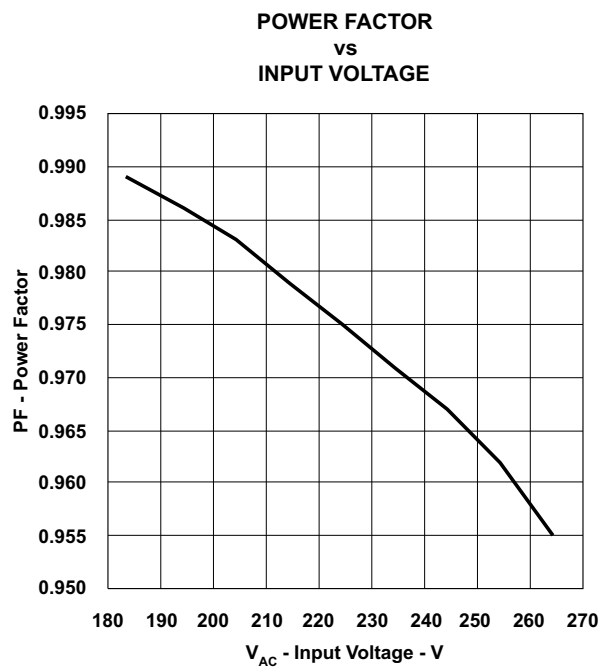

Figure 6. Power Factor Performance

7.4 Load Regulation

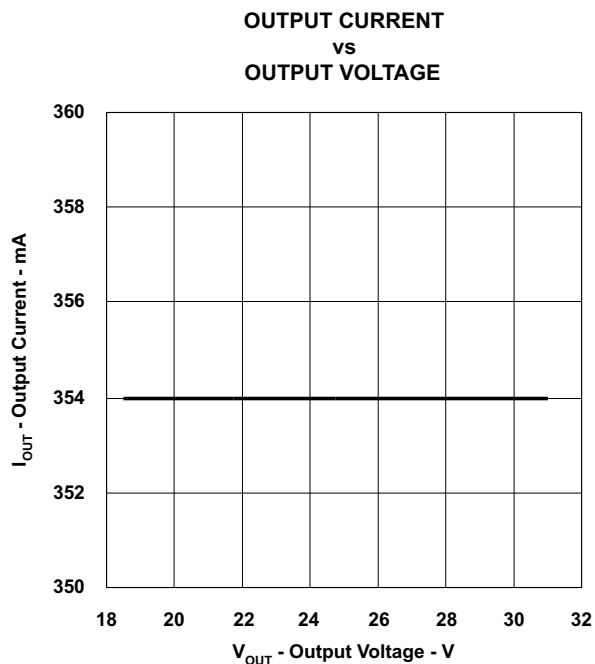

Figure 7. Load Regulation

7.5 Bode Plot

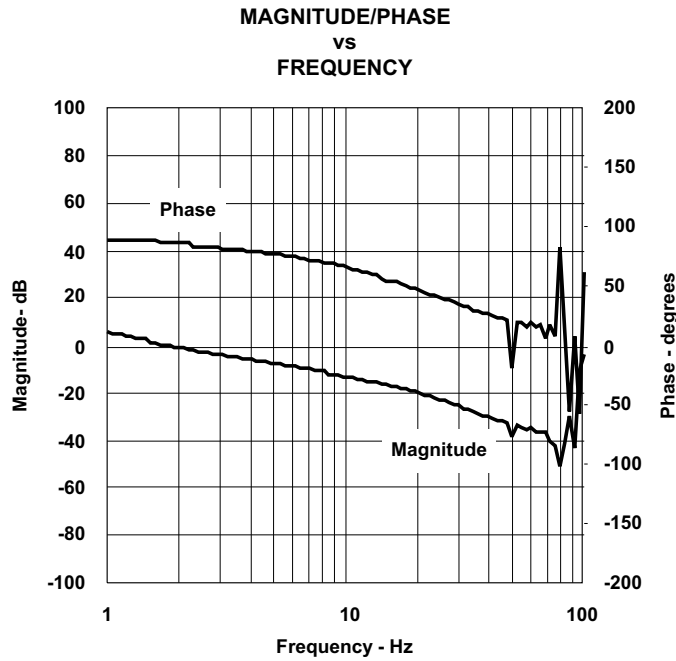

Figure 8. Loop Response Gain and Phase (crossover: 1.8 Hz, 86 degrees phase margin)

7.6 TRIAC Dimmer Performance

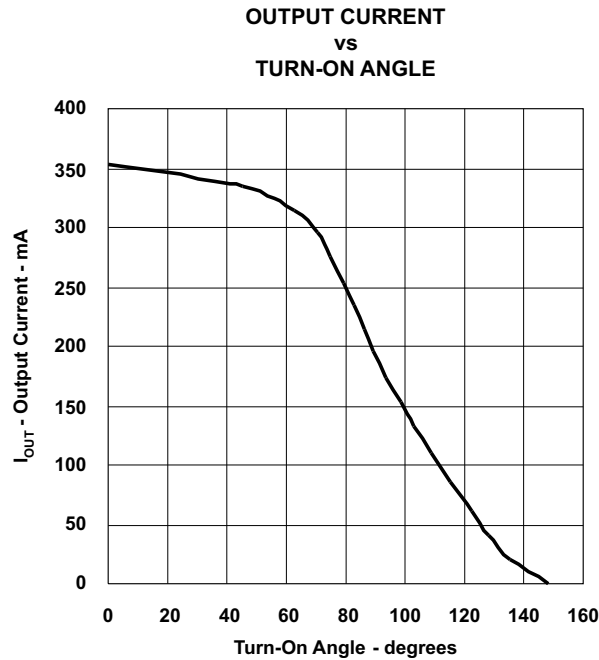

Figure 9. TRIAC Dimmer Performance

7.7 Output Ripple

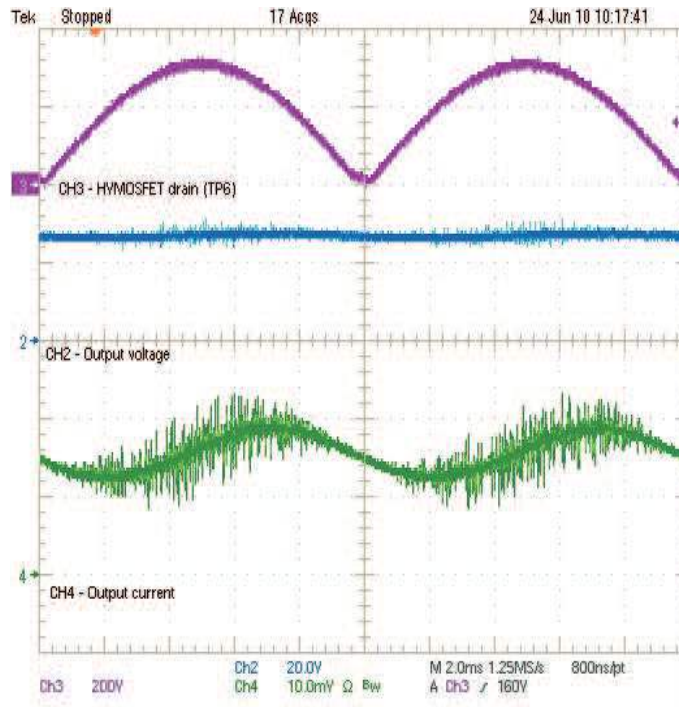

Figure 10. Output Ripple (CH4 – 200 mA/10 mV)

7.8 Switch-Node Voltage

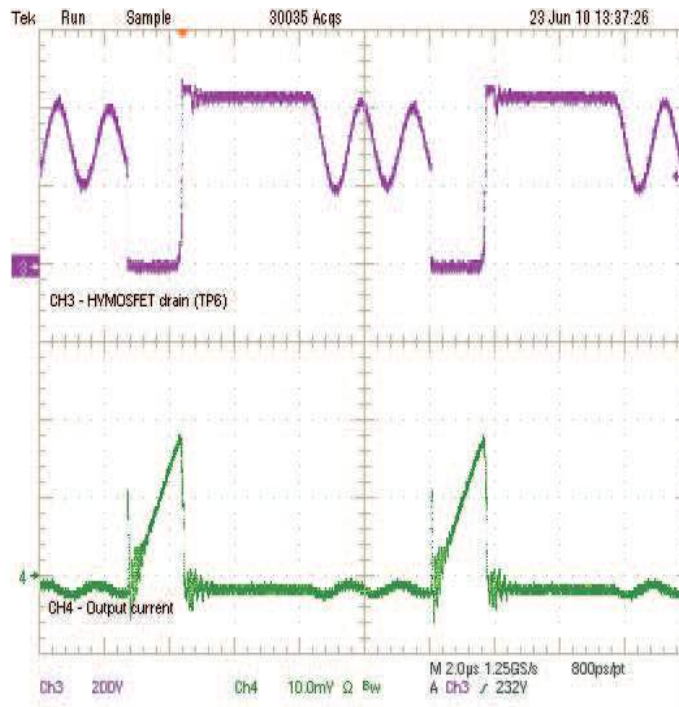

Figure 11. Switching-Node Waveform (CH4 – 200 mA/10 mV)

7.9 Turn On Waveform

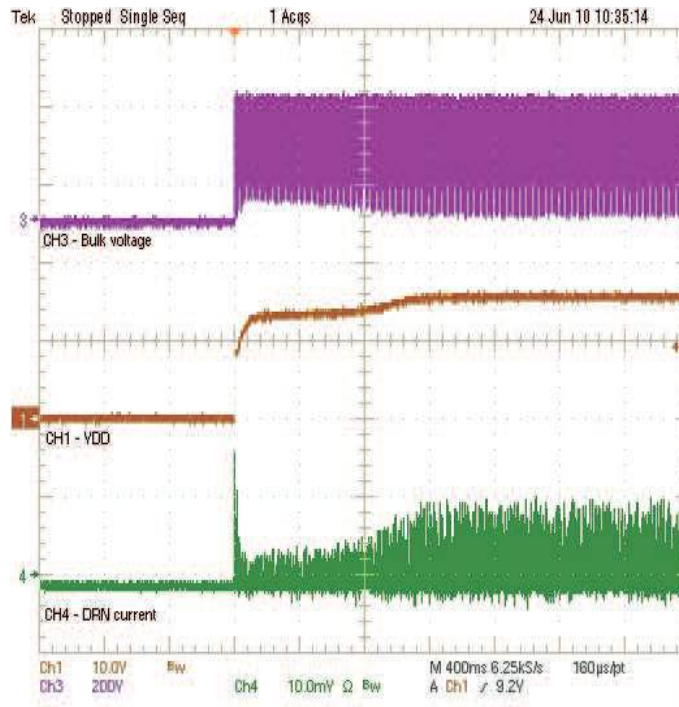

Figure 12. Turn-On Waveform (CH4 – 500 mA/10 mV)

7.10 Turn Off Waveform

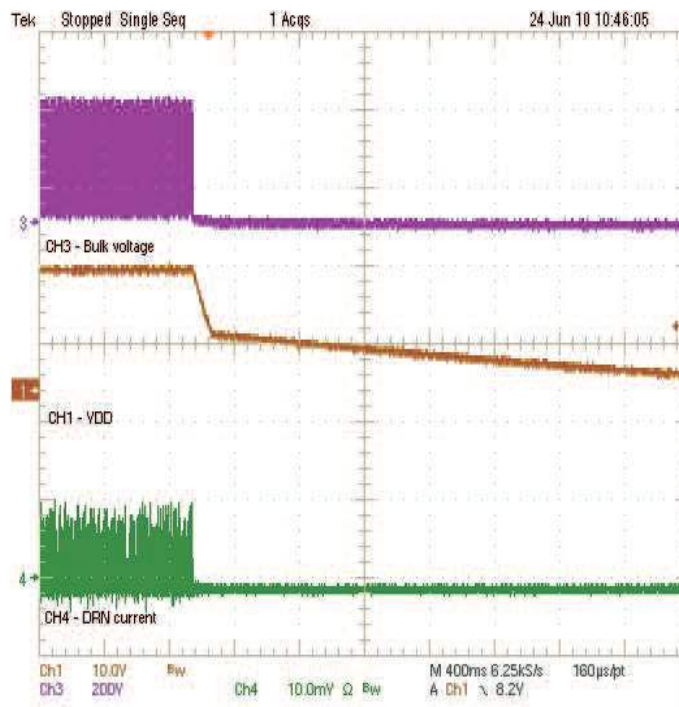

Figure 13. Turn-Off Waveform (CH4 – 500 mA/10 mV)

7.11 TRIAC Dimming Waveform

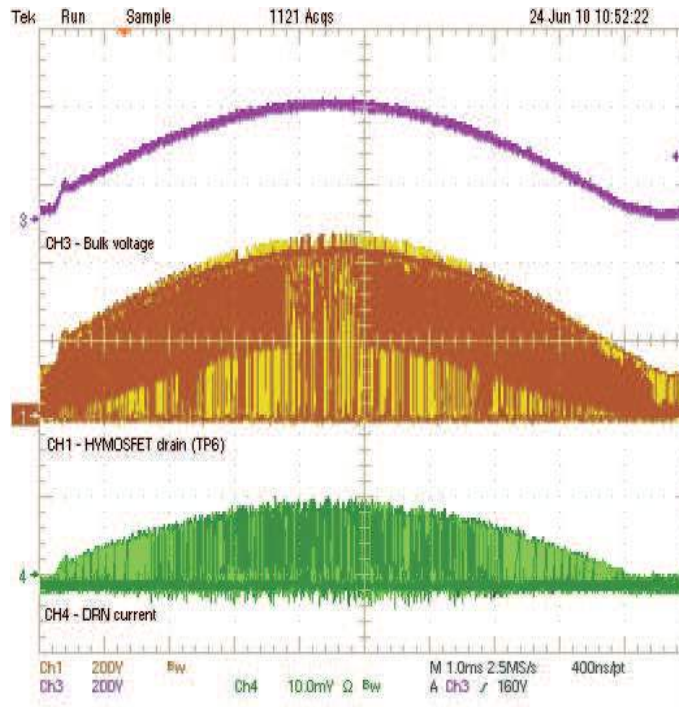

Figure 14. TRIAC Triggering at 100% (CH4 – 500 mA/10 mV)

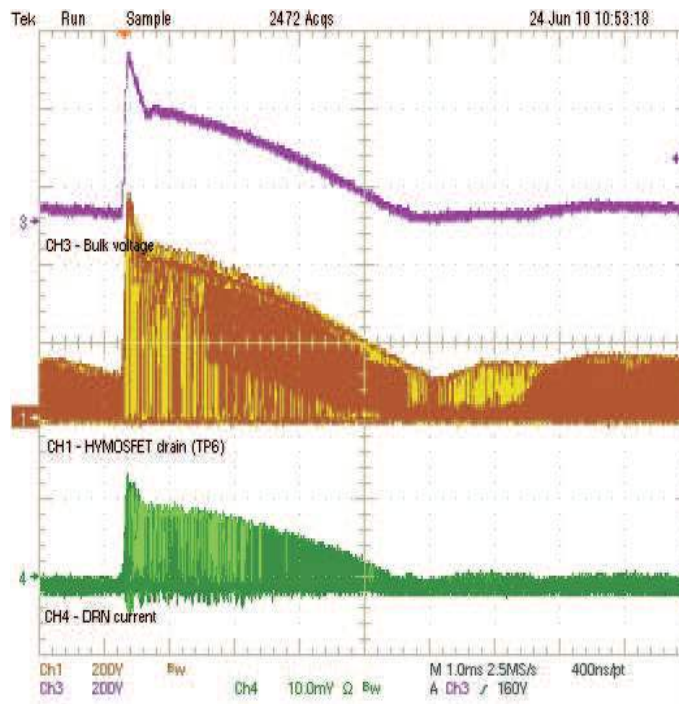

Figure 15. TRIAC Triggering at 50% (CH4 – 500 mA/10 mV)

8 EVM Assembly Drawing and PCB layout

The following figures (Figure 16 through Figure 19) show the design of the TPS92210EVM-613 printed circuit board.

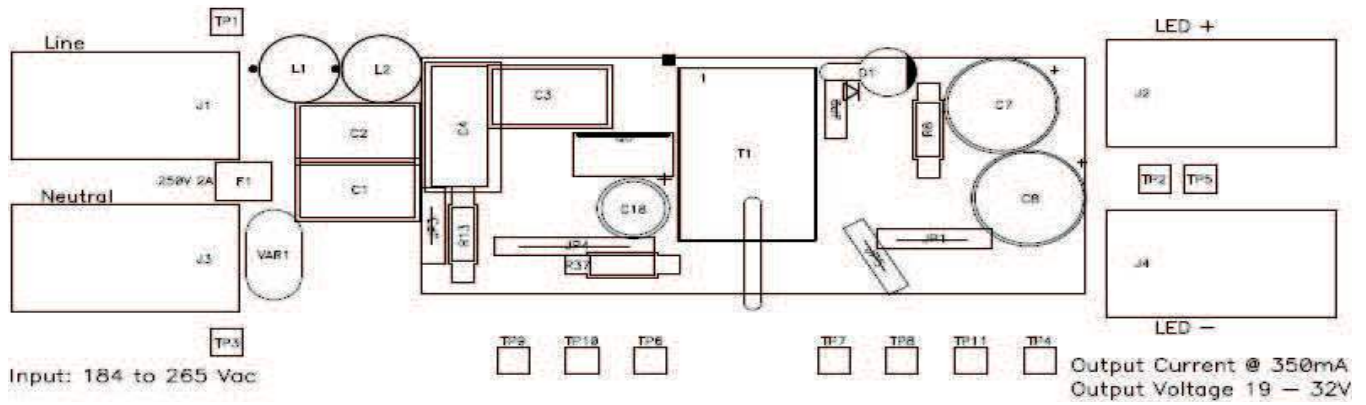

Figure 16. Top Layer Assembly Drawing (top view)

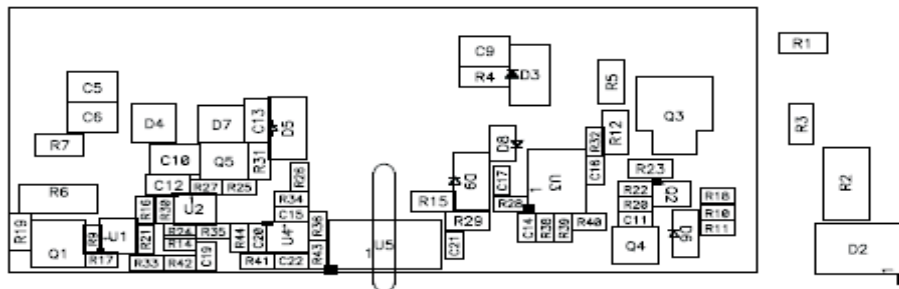

Figure 17. Bottom Assembly Drawing (bottom view)

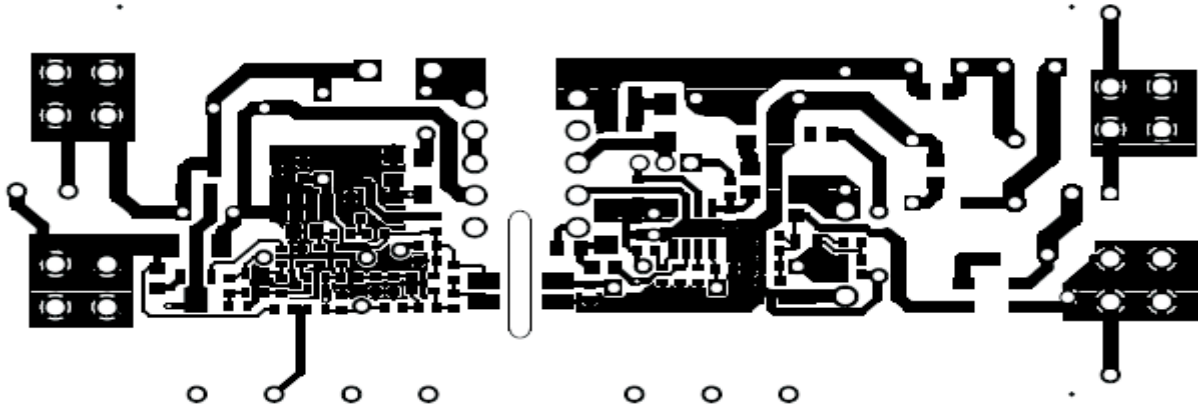

Figure 18. Bottom Copper (bottom view)

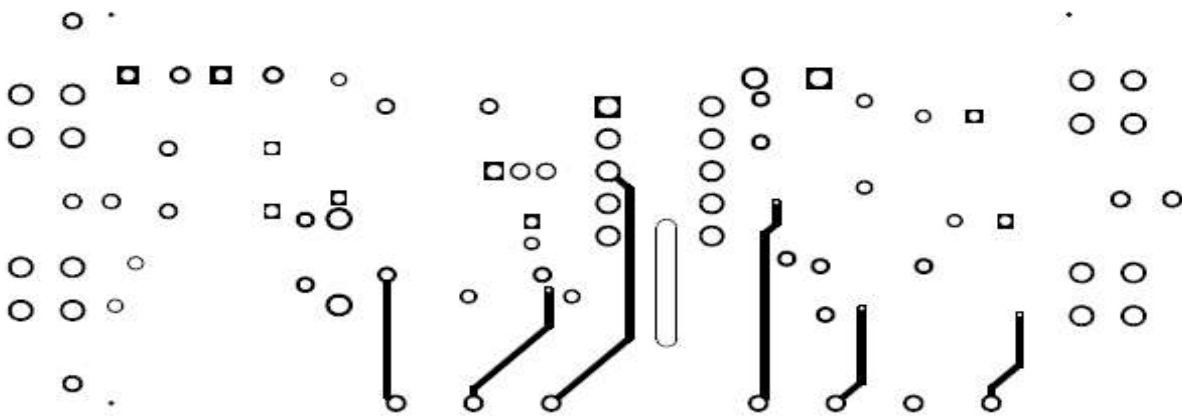

Figure 19. Internal Layer 1 (top view)

9 List of Materials

The EVM components list according to the schematic shown in [Figure 1](#)

Table 3. List of Materials

COUNT	REFDES	DESCRIPTION	PART NUMBER	MFR
2	C1, C2	Capacitor, metal polyester, 0.01 μ F, 630 V, 85°C, +/-10%, 12 mm x 4.5 mm	ECQ-E6103KF	Panasonic
1	C3	Capacitor, polyester film, 22 nF, 630 V, \pm 10%, 0.260 inch x 0.470 inch	ECQ-E6223KZ	Panasonic
1	C4	Capacitor, polypropylene film, 200 nF, 630 V, \pm 10%, 0.256 inch x 0.650 inch	ECW-F6204JL	Panasonic
2	C5, C6	Capacitor, ceramic, 10 μ F, 50 V, X7R, \pm 10%, 1210	Std	Std
2	C7, C8	Capacitor, aluminum electrolytic, 560 μ F, 50 V, \pm 20%, 12.5 mm x 25 mm	UPW1H561MHD	Rubycon/Nichicon
2	C9, C10	Capacitor, ceramic, 0.015 μ F, 100 V, \pm 5%, 1210	GRM3291X2A222JZ01	Murata
1	C11	Capacitor, ceramic, 220 pF, 50 V, X7R, \pm 10%, 0603	Std	Std
1	C12	Capacitor, ceramic, 1.0 μ F, 10 V, X7R, \pm 10%, 0805	Std	Std
1	C13	Capacitor, ceramic, 220 pF, 100 V, 125°C, \pm 5%, 1206	12061A221JAT2A	AVX
6	C14, C15, C16, C19, C20, C21	Capacitor, ceramic, 0.01 μ F, 50 V, X7R, \pm 10%, 0603	Std	Std
1	C17	Capacitor, ceramic, 0.1 μ F, 25 V, X7R, \pm 10%, 0603	Std	Std
1	C18	Capacitor, aluminum, 100 μ F, 25 V, \pm 20%, 0.200 inch	EEU-FC1E101S	Panasonic
1	C22	Capacitor, ceramic, 0.22 μ F, 25 V, X7R, \pm 10%, 0603	Std	Std
1	D1	Diode, ultrafast, power rectifier, 1 A, 100 V, DO-201AD	MUR220RLG	On Semiconductor
1	D2	Diode, bridge rectifier, 0.5 A, 600 V, SO-4	MB6S	Fairchild
1	D3	Diode, ultra fast rectifier, 1 A, 800 V, SMA	RS1K-13-F	Diodes, Inc.
1	D4	Diode, shunt voltage reference, SOT-23	LM4040C50	Texas Instruments
1	D5	Diode, super fast rectifier, 1A, 200V, 0.220 inch x 0.115 inch	ES1D	Diodes, Inc.
1	D6	Diode, Zener, 18 V, 500 mW, SOD-123	MMSZ18T1G	On Semiconductor
1	D7	Diode, switching, dual, 200 mA, 70 V, SOT-23	MMBD6100LT1G	On Semiconductor
1	D8	Diode, Schottky, 1 A, 30 V, SOD-323	SDM100K30	Diodes, Inc
1	D9	Diode, ultra fast, 1 A, 200 V, SMA	CSFA103-G	On Semiconductor
1	F1	Fuse, axial, fast acting, 2.5 A, 250V, 0.160 x 0.400 inch	026302.5WRT1-L	Littelfuse
2	L1, L2	Inductor, radial, 470 μ H, 310 mA, +/-10%, 70°C, 0.315 inch Diameter	22R474C	Murata
1	Q1	Bipolar, NPN, 100 V, 1 A, SOT-89	FCX493TA	Zetex
1	Q2	Bipolar, complementary, NPN/PNP 60/40 V, 600 mA, SOT-363	MMDT4413-7-F	Diodes, Inc.
1	Q3	MOSFET, N-channel, 600 V, 0.4 A, 8.5 W, SOT-223	STN1HNK60	STMicroelectronics
1	Q4	MOSFET, N-channel, 60 V, 115 mA, SOT-23	2N7002	Std
1	Q5	Bipolar, NPN, 40 V, 200 mA, 350 mW, SOT-23	MMBT3904-TP	Micro Commercial Co
1	Q6	MOSFET, N-channel, 650 V, 7.3 A, 0.6 W, TO-220	SPA07N60C3	Infineon
1	R1	Resistor, chip, 499 Ω , 1/4 W, \pm 1%, 1206	Std	Std
1	R2	Resistor, metal oxide, 33 Ω , 1 W, \pm 5%, 2512	ERG-1SJ330	Panasonic
1	R3	Resistor, chip, 249 Ω , 1/4 W, \pm 1%, 1206	Std	Std
1	R4	Resistor, chip, 75.0 k Ω , 1/4 W, \pm 1%, 1206	Std	Std
2	R5, R12	Resistor, chip, 1.00 M Ω , 1/4 W, \pm 1%, 1206	Std	Std
1	R6	Resistor, chip, 0.51 Ω , 1/2 W, \pm 1%, 2010	Std	Std
1	R7	Resistor, chip, 1.00 k Ω , 1/4 W, \pm 5%, 1206	Std	Std
1	R8	Resistor, metal film, 5.11 k Ω , 1/2 W, \pm 1%, RN55	Std	Std

Table 3. List of Materials (continued)

COUNT	REFDES	DESCRIPTION	PART NUMBER	MFR
2	R9, R41	Resistor, chip, 200 k Ω , 1/10 W, $\pm 1\%$, 0603	Std	Std
1	R10	Resistor, chip, 10.0 k Ω , 1/10 W, $\pm 1\%$, 0603	Std	Std
2	R11, R18	Resistor, chip, 49.9 k Ω , 1/10 W, $\pm 1\%$, 0603	Std	Std
1	R13	Resistor, carbon film, 510 Ω , 1/2 W, $\pm 5\%$, RN55	Std	Std
3	R14, R24, R40	Resistor, chip, 100 k Ω , 1/10 W, $\pm 1\%$, 0603	Std	Std
1	R15	Resistor, chip, 3.01 Ω , 1/8 W, $\pm 1\%$, 0805	Std	Std
1	R16	Resistor, chip, 4.42 k Ω , 1/10 W, $\pm 1\%$, 0603	Std	Std
1	R17	Resistor, chip, 71.5 k Ω , 1/10 W, $\pm 1\%$, 0603	Std	Std
1	R19	Resistor, chip, 39.2 Ω , 1/8 W, $\pm 1\%$, 0805	Std	Std
1	R20	Resistor, chip, 681 k Ω , 1/10 W, $\pm 1\%$, 0603	Std	Std
1	R21	Resistor, chip, 464 k Ω , 1/10 W, $\pm 1\%$, 0603	Std	Std
1	R22	Resistor, chip, 100 Ω , 1/10 W, $\pm 1\%$, 0603	Std	Std
1	R23	Resistor, chip, 2.37 Ω , 1/8 W, $\pm 1\%$, 0805	Std	Std
1	R25	Resistor, chip, 511 k Ω , 1/10 W, $\pm 1\%$, 0603	Std	Std
1	R26	Resistor, Chip, 274 k Ω , 1/10 W, $\pm 1\%$, 0603	Std	Std
1	R27	Resistor, chip, 20.0 k Ω , 1/10 W, $\pm 1\%$, 0603	Std	Std
1	R28	Resistor, chip, 634 k Ω , 1/10 W, $\pm 1\%$, 0603	Std	Std
1	R29	Resistor, chip, 110 k Ω , 1/8 W, $\pm 1\%$, 0805	Std	Std
1	R30	Resistor, chip, 7.5 k Ω , 1/10 W, $\pm 1\%$, 0603	Std	Std
1	R31	Resistor, chip, 1.0 M Ω , 1/8 W, $\pm 1\%$, 0805	Std	Std
1	R32	Resistor, chip, 4.99 Ω , 1/10 W, $\pm 1\%$, 0603	Std	Std
1	R33	Resistor, chip, 49.9 Ω 1/10 W, $\pm 1\%$, 0603	Std	Std
1	R34	Resistor, chip, 1.00 M Ω , 1/10 W, $\pm 1\%$, 0603	Std	Std
1	R35	Resistor, chip, 604 k Ω , 1/10 W, $\pm 1\%$, 0603	Std	Std
2	R36, R43	Resistor, chip, 3.01 k Ω , 1/10 W, $\pm 1\%$, 0603	Std	Std
1	R37	Resistor, carbon film, 10.0 k Ω , 1/2 W, $\pm 5\%$, RN55	Std	Std
1	R38	Resistor, chip, 33.2 k Ω , 1/10 W, $\pm 1\%$, 0603	Std	Std
1	R39	Resistor, chip, 40.2 k Ω , 1/10 W, $\pm 1\%$, 0603	Std	Std
1	R42	Resistor, chip, 2.00 k Ω , 1/10 W, $\pm 1\%$, 0603	Std	Std
1	R44	Resistor, chip, 23.7 k Ω , 1/10 W, $\pm 1\%$, 0603	Std	Std
1	T1	Transformer, 1200 μ H, $\pm 10\%$, 0.567 inch x 0.876 inch	750811145	Würth Midcom
3	U1, U2, U4	Op-Amp Low Voltage Rail-to-Rail Output, 130 μ A Typical, SOT-23-5	LMV321IDBVR	Texas Instruments
1	U3	PFC LED Lighting Driver Controller, SO-8	TPS92210D	Texas Instruments
1	U5	Optocoupler, High Isolation Voltage, SOP4 Gull-Wing	PS2561L-1-A	NEC
1	VAR1	Varistor, Disk, 220 V, 8.5 mm Dia.	ERZ-V07D221	Panasonic

Evaluation Board/Kit Important Notice

Texas Instruments (TI) provides the enclosed product(s) under the following conditions:

This evaluation board/kit is intended for use for **ENGINEERING DEVELOPMENT, DEMONSTRATION, OR EVALUATION PURPOSES ONLY** and is not considered by TI to be a finished end-product fit for general consumer use. Persons handling the product(s) must have electronics training and observe good engineering practice standards. As such, the goods being provided are not intended to be complete in terms of required design-, marketing-, and/or manufacturing-related protective considerations, including product safety and environmental measures typically found in end products that incorporate such semiconductor components or circuit boards. This evaluation board/kit does not fall within the scope of the European Union directives regarding electromagnetic compatibility, restricted substances (RoHS), recycling (WEEE), FCC, CE or UL, and therefore may not meet the technical requirements of these directives or other related directives.

Should this evaluation board/kit not meet the specifications indicated in the User's Guide, the board/kit may be returned within 30 days from the date of delivery for a full refund. **THE FOREGOING WARRANTY IS THE EXCLUSIVE WARRANTY MADE BY SELLER TO BUYER AND IS IN LIEU OF ALL OTHER WARRANTIES, EXPRESSED, IMPLIED, OR STATUTORY, INCLUDING ANY WARRANTY OF MERCHANTABILITY OR FITNESS FOR ANY PARTICULAR PURPOSE.**

The user assumes all responsibility and liability for proper and safe handling of the goods. Further, the user indemnifies TI from all claims arising from the handling or use of the goods. Due to the open construction of the product, it is the user's responsibility to take any and all appropriate precautions with regard to electrostatic discharge.

EXCEPT TO THE EXTENT OF THE INDEMNITY SET FORTH ABOVE, NEITHER PARTY SHALL BE LIABLE TO THE OTHER FOR ANY INDIRECT, SPECIAL, INCIDENTAL, OR CONSEQUENTIAL DAMAGES.

TI currently deals with a variety of customers for products, and therefore our arrangement with the user **is not exclusive.**

TI assumes **no liability for applications assistance, customer product design, software performance, or infringement of patents or services described herein.**

Please read the User's Guide and, specifically, the Warnings and Restrictions notice in the User's Guide prior to handling the product. This notice contains important safety information about temperatures and voltages. For additional information on TI's environmental and/or safety programs, please contact the TI application engineer or visit www.ti.com/esh.

No license is granted under any patent right or other intellectual property right of TI covering or relating to any machine, process, or combination in which such TI products or services might be or are used.

FCC Warning

This evaluation board/kit is intended for use for **ENGINEERING DEVELOPMENT, DEMONSTRATION, OR EVALUATION PURPOSES ONLY** and is not considered by TI to be a finished end-product fit for general consumer use. It generates, uses, and can radiate radio frequency energy and has not been tested for compliance with the limits of computing devices pursuant to part 15 of FCC rules, which are designed to provide reasonable protection against radio frequency interference. Operation of this equipment in other environments may cause interference with radio communications, in which case the user at his own expense will be required to take whatever measures may be required to correct this interference.

EVM Warnings and Restrictions

It is important to operate this EVM within the input voltage range of 184 VAC to 265 VAC and the output voltage range of 19 VDC to 32 VDC .

Exceeding the specified input range may cause unexpected operation and/or irreversible damage to the EVM. If there are questions concerning the input range, please contact a TI field representative prior to connecting the input power.

Applying loads outside of the specified output range may result in unintended operation and/or possible permanent damage to the EVM. Please consult the EVM User's Guide prior to connecting any load to the EVM output. If there is uncertainty as to the load specification, please contact a TI field representative.

During normal operation, some circuit components may have case temperatures greater than 50° C. The EVM is designed to operate properly with certain components above 50° C as long as the input and output ranges are maintained. These components include but are not limited to linear regulators, switching transistors, pass transistors, and current sense resistors. These types of devices can be identified using the EVM schematic located in the EVM User's Guide. When placing measurement probes near these devices during operation, please be aware that these devices may be very warm to the touch.

Mailing Address: Texas Instruments, Post Office Box 655303, Dallas, Texas 75265
Copyright © 2010, Texas Instruments Incorporated

IMPORTANT NOTICE

Texas Instruments Incorporated and its subsidiaries (TI) reserve the right to make corrections, modifications, enhancements, improvements, and other changes to its products and services at any time and to discontinue any product or service without notice. Customers should obtain the latest relevant information before placing orders and should verify that such information is current and complete. All products are sold subject to TI's terms and conditions of sale supplied at the time of order acknowledgment.

TI warrants performance of its hardware products to the specifications applicable at the time of sale in accordance with TI's standard warranty. Testing and other quality control techniques are used to the extent TI deems necessary to support this warranty. Except where mandated by government requirements, testing of all parameters of each product is not necessarily performed.

TI assumes no liability for applications assistance or customer product design. Customers are responsible for their products and applications using TI components. To minimize the risks associated with customer products and applications, customers should provide adequate design and operating safeguards.

TI does not warrant or represent that any license, either express or implied, is granted under any TI patent right, copyright, mask work right, or other TI intellectual property right relating to any combination, machine, or process in which TI products or services are used. Information published by TI regarding third-party products or services does not constitute a license from TI to use such products or services or a warranty or endorsement thereof. Use of such information may require a license from a third party under the patents or other intellectual property of the third party, or a license from TI under the patents or other intellectual property of TI.

Reproduction of TI information in TI data books or data sheets is permissible only if reproduction is without alteration and is accompanied by all associated warranties, conditions, limitations, and notices. Reproduction of this information with alteration is an unfair and deceptive business practice. TI is not responsible or liable for such altered documentation. Information of third parties may be subject to additional restrictions.

Resale of TI products or services with statements different from or beyond the parameters stated by TI for that product or service voids all express and any implied warranties for the associated TI product or service and is an unfair and deceptive business practice. TI is not responsible or liable for any such statements.

TI products are not authorized for use in safety-critical applications (such as life support) where a failure of the TI product would reasonably be expected to cause severe personal injury or death, unless officers of the parties have executed an agreement specifically governing such use. Buyers represent that they have all necessary expertise in the safety and regulatory ramifications of their applications, and acknowledge and agree that they are solely responsible for all legal, regulatory and safety-related requirements concerning their products and any use of TI products in such safety-critical applications, notwithstanding any applications-related information or support that may be provided by TI. Further, Buyers must fully indemnify TI and its representatives against any damages arising out of the use of TI products in such safety-critical applications.

TI products are neither designed nor intended for use in military/aerospace applications or environments unless the TI products are specifically designated by TI as military-grade or "enhanced plastic." Only products designated by TI as military-grade meet military specifications. Buyers acknowledge and agree that any such use of TI products which TI has not designated as military-grade is solely at the Buyer's risk, and that they are solely responsible for compliance with all legal and regulatory requirements in connection with such use.

TI products are neither designed nor intended for use in automotive applications or environments unless the specific TI products are designated by TI as compliant with ISO/TS 16949 requirements. Buyers acknowledge and agree that, if they use any non-designated products in automotive applications, TI will not be responsible for any failure to meet such requirements.

Following are URLs where you can obtain information on other Texas Instruments products and application solutions:

Products		Applications	
Amplifiers	amplifier.ti.com	Audio	www.ti.com/audio
Data Converters	dataconverter.ti.com	Automotive	www.ti.com/automotive
DLP® Products	www.dlp.com	Communications and Telecom	www.ti.com/communications
DSP	dsp.ti.com	Computers and Peripherals	www.ti.com/computers
Clocks and Timers	www.ti.com/clocks	Consumer Electronics	www.ti.com/consumer-apps
Interface	interface.ti.com	Energy	www.ti.com/energy
Logic	logic.ti.com	Industrial	www.ti.com/industrial
Power Mgmt	power.ti.com	Medical	www.ti.com/medical
Microcontrollers	microcontroller.ti.com	Security	www.ti.com/security
RFID	www.ti-rfid.com	Space, Avionics & Defense	www.ti.com/space-avionics-defense
RF/IF and ZigBee® Solutions	www.ti.com/lprf	Video and Imaging	www.ti.com/video
		Wireless	www.ti.com/wireless-apps