



Features

- Universal AC input / Full range
- Fanless design, 400W convection
- Modular design, optional configuration available
- Slim and 1U low profile
- No minimum load required
- Protections: Short circuit / Overload / Over voltage / Over temperature
- -30 ~ +70°C working temperature
- LED indicator for power on
- 3 years warranty

Applications

- Diagnostic or biological facilities
- Test or measurement systems
- Telecommunication equipment
- Industrial automation machinery
- Industrial control system
- Mechanical and electrical equipment

GTIN CODE

MW Search: <https://www.meanwell.com/serviceGTIN.aspx>

Description

The UMP-400 series is the break-through 1U height modular power supply from MEAN WELL, and it can deliver up to 400W maximum output power with convection cooling only. The front-end can function as an independent 400W 24V or 48V single output power supply, and it can be configured into a multi-channel modular power supply by incorporating the NID series non-isolated DC-DC converters, which are also standalone standard products that can be purchased and used separately. The NID output modules can deliver up to 100W with adjustable options for the major working voltages used in the industry, including 5V, 12V, 15V and 24V. In addition, the UMP-400 series is certified to ITE 62368-1 safety standards, and is designed to meet medical (2xMOPP) safety standard, thus offering the best flexibility for various types of applications.

Output Configuration Guide (Please contact MEAN WELL sales or distributors for multi-channel configurations)

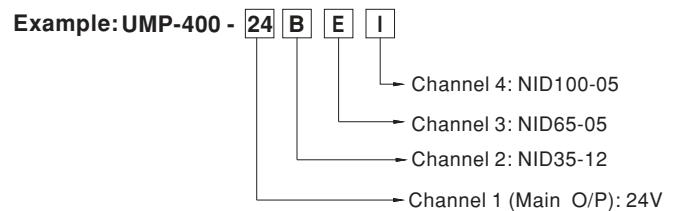
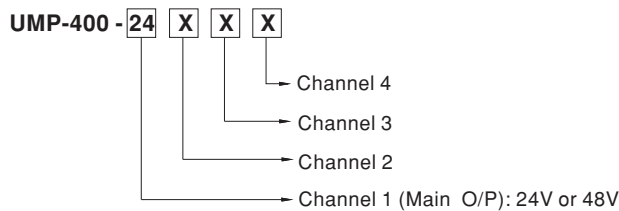

| DC-DC O/P Module | O/P Voltage | O/P Current |
|------------------|-------------|-------------|
| A | NID35-05 | 5V 3.5A |
| B | NID35-12 | 12V 2.9A |
| C | NID35-15 | 15V 2.4A |
| D | NID35-24 | 24V 1.5A |
| E | NID65-05 | 5V 6.5A |
| F | NID65-12 | 12V 4.9A |
| G | NID65-15 | 15V 4.3A |
| H | NID65-24 | 24V 2.7A |
| I | NID100-05 | 5V 8.0A |
| J | NID100-12 | 12V 6.0A |
| K | NID100-15 | 15V 5.2A |
| L | NID100-24 | 24V 3.4A |

| DC-DC O/P Module | O/P Voltage | O/P Current |
|------------------|-------------|-------------|
| M | NID35-05 | -5V -3.5A |
| N | NID35-12 | -12V -2.9A |
| O | NID35-15 | -15V -2.4A |
| P | NID65-05 | -5V -6.5A |
| Q | NID65-12 | -12V -4.9A |
| R | NID65-15 | -15V -4.3A |
| S | NID100-05 | -5V -8.0A |
| T | NID100-12 | -12V -6.0A |
| U | NID100-15 | -15V -5.2A |

Note:

- 1: NID35/65/100-24 modules are intended for UMP-400-48 only.
- 2: Only UMP-400-24 can be configured with negative output voltage modules.
- 3: Only output channel 4(V4) may be configured as negative voltage.

SPECIFICATION

| MODEL | | UMP-400-24 | UMP-400-48 | |
|----------------------------------|---|---|---|-------------------|
| SINGLE OUTPUT (Standard model) | DC VOLTAGE | 24V | 48V | |
| | RATED CURRENT | 16.7A | 8.3A | |
| | RATED OUTPUT POWER | 400W max. | | |
| | VOLTAGE ADJ. RANGE | 22.8 ~ 25.2V | 45.6 ~ 50.4V | |
| | RIPPLE & NOISE (max.) Note.2 | 240mVp-p | 360mVp-p | |
| | VOLTAGE TOLERANCE Note.3 | ± 1.0% | ± 1.0% | |
| | LINE REGULATION | ± 0.5% | ± 0.5% | |
| | LOAD REGULATION | ± 1.0% | ± 1.0% | |
| | SETUP, RISE TIME | 1000ms, 50ms/230Vac ; 2000ms, 50ms/115Vac | | |
| HOLD UP TIME (Typ.) | 12ms@230Vac ; 12ms@115Vac | | | |
| MULTIPLE OUTPUT (Optional Model) | DC VOLTAGE | CH1 output 24V or 48V + NID DC modules for CH2,3,4 | | |
| | TOTAL OUTPUT POWER | CH2,3,4 output power can be flexible depending on NID selection. Combined power on all channels must not exceed 400W | | |
| INPUT | VOLTAGE RANGE Note.4 | 90 ~ 264VAC | 127 ~ 370VDC | |
| | FREQUENCY RANGE | 47 ~ 63Hz | | |
| | POWER FACTOR | PF>0.95/230VAC PF>0.98/115VAC at full load | | |
| | EFFICIENCY(Typ.) Note.5 | 88.5%, full case load with each type of module at nominal voltage | | |
| | AC CURRENT | 2.5A/230VAC | 4.7A/115VAC | |
| | INRUSH CURRENT | 40A/230VAC | 25A/115VAC | |
| | LEAKAGE CURRENT | Earth leakage current <300uA / 264VAC, Touch current <100uA/264VAC | | |
| PROTECTION | OVERLOAD | 105 ~ 135% rated output power Protection type CH1: constant current limiting protection (If a long short circuit continues, the OTP action will be triggered), CH2,CH3,CH4: Hiccup mode protection | | |
| | OVER VOLTAGE | 26.4 ~ 31.2V | 52.8 ~ 62.4V | |
| | OVER TEMPERATURE | Shut down o/p voltage, re-power on to recover | | |
| ENVIRONMENT | WORKING TEMP. | -30 ~ +70°C (Refer to "Derating Curve") | | |
| | WORKING HUMIDITY | 20 ~ 90% RH non-condensing | | |
| | STORAGE TEMP. | -40 ~ +85°C | | |
| | TEMP. COEFFICIENT | ±0.03%/°C (0 ~ 50°C) | | |
| | VIBRATION | 10~500Hz, 2G 10min./1 cycle, 60 min. each along X, Y, Z axes | | |
| | OPERATING ALTITUDE Note.6 | 5000 meters /OVC II | | |
| SAFETY & EMC (Note 7) | OVER VOLTAGE GATEGORY | III ; According to IEC62368-1; altitude up to 2000 meters | | |
| | SAFETY STANDARDS | EAC TP TC 004; UL62368-1, Dekra BS EN/EN62368-1 approved; Design refer to ANSI/AAMI ES60601-1, TUV BS EN/EN60601-1, IEC 60601-1 (3 rd edition) | | |
| | ISOLATION LEVEL | Primary-Secondary: 2x MOPP, Primary-Earth: 1x MOPP | | |
| | WITHSTAND VOLTAGE | I/P-O/P: 4KVAC I/P-FG: 2KVAC O/P-FG: 1.5KVAC | | |
| | ISOLATION RESISTANCE | I/P-O/P, I/P-FG, O/P-FG: 100M Ohms / 500VDC / 25°C / 70% RH | | |
| | EMC EMISSION | Parameter | Standard | Test Level / Note |
| | | Conducted | BS EN/EN55032 (CISPR32) / Design refer to BS EN/EN55011 (CISPR11) Class B | |
| | | Radiated | BS EN/EN55032 (CISPR32) / Design refer to BS EN/EN55011 (CISPR11) Class B | |
| | | Harmonic Current | BS EN/EN61000-3-2 Class A | |
| | Voltage Flicker | BS EN/EN61000-3-3 ----- | | |
| EMC IMMUNITY | Parameter | Standard | Test Level / Note | |
| | ESD | BS EN/EN61000-4-2 Level 4, 8KV air; Level 4, 4KV contact | | |
| | RF field | BS EN/EN61000-4-3 Level 3, 3V/m | | |
| | EFT/ Burst | BS EN/EN61000-4-4 Level 3, 1KV | | |
| | Surge | BS EN/EN61000-4-5 Level 4, 2KV/Line-FG; 1KV/Line-Line | | |
| | Conducted | BS EN/EN61000-4-6 Level 2, 3V | | |
| | Magnetic Field | BS EN/EN61000-4-8 Level 1, 1A/m | | |
| | Voltage Dips and Interruptions | BS EN/EN61000-4-11 100% dip 1 periods, 30% dip 25 periods, 100% interruptions 250 periods | | |
| OTHERS | MTBF | 1428.4K hrs min. Telcordia SR-332 (Bellcore) ; 187.3K hrs min. MIL-HDBK-217F (25°C) | | |
| | DIMENSION | 250*89*37mm (L*W*H) | | |
| | PACKING | 0.88Kg; 14pcs/13Kg/0.89CUFT | | |
| NOTE | <p>1. All parameters NOT specifically mentioned are measured at 230VAC input, rated load and 25°C of ambient temperature.</p> <p>2. Ripple & noise are measured at 20MHz of bandwidth by using a 12" twisted pair-wire terminated with a 0.1 μf & 47 μf parallel capacitor.</p> <p>3. Tolerance: includes set up tolerance, line regulation and load regulation.</p> <p>4. De-rating may be needed under low input voltages. Please check the derating curve for more details.</p> <p>5. The efficiency changes by installing different output modules.</p> <p>6. The ambient temperature derating of 3.5°C/1000m with fanless models and of 5°C/1000m with fan models for operating altitude higher than 2000m (6500ft).</p> <p>7. The power supply is considered a component which will be installed into a final equipment. All the EMC tests are been executed by mounting the unit on a 450mm*450mm metal plate with 3mm of thickness. The final equipment must be re-confirmed that it still meets EMC directives. For guidance on how to perform these EMC tests, please refer to "EMI testing of component power supplies." (as available on http://www.meanwell.com)</p> <p>※ Product Liability Disclaimer : For detailed information, please refer to https://www.meanwell.com/serviceDisclaimer.aspx</p> | | | |

■ BLOCK DIAGRAM

PFC : 65KHz
PWM : 85KHz

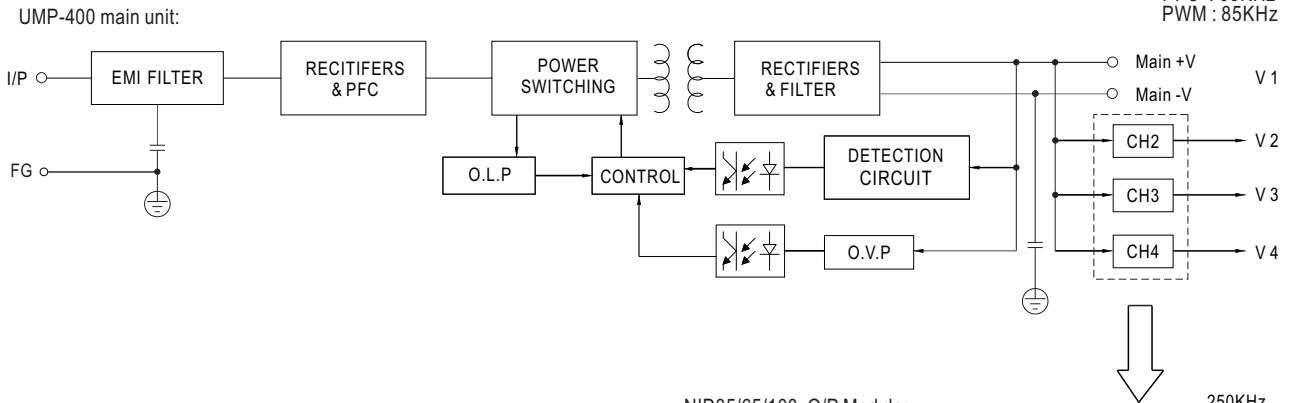

NID35/65/100 O/P Module:

250KHz

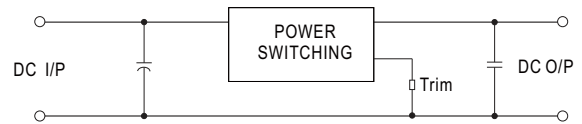

■ Derating Curve

⊙ Operate without cooling plate

UMP-400-24/48 (Single Output):

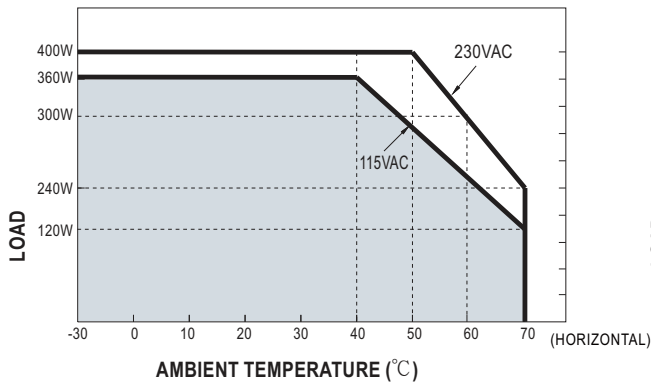

UMP-400-24/48XXX (Multi-channels):

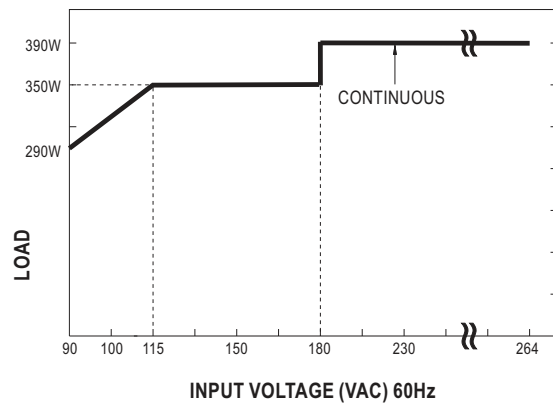
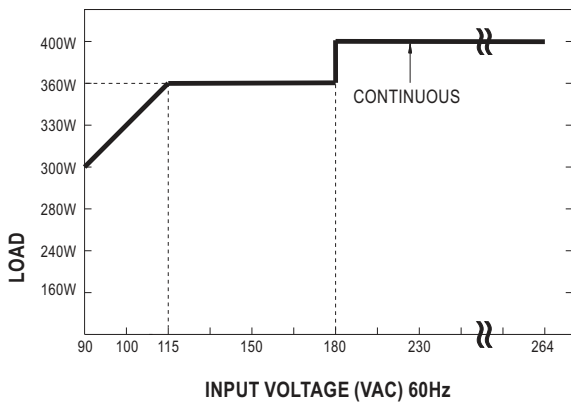
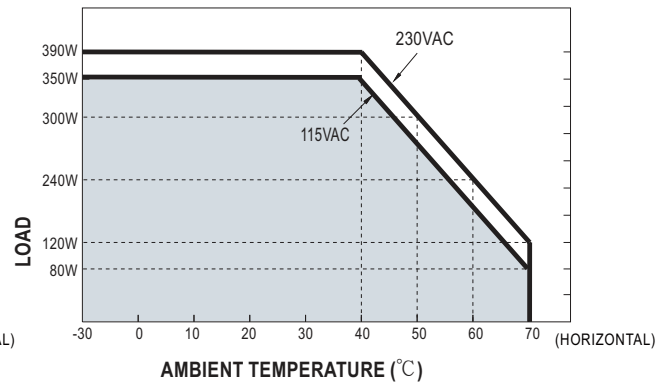

⊙ **Operate with cooling plate**

The UMP can operate under an extended temperature range with the addition of a 450x450x3mm aluminum plate.

Unit:mm

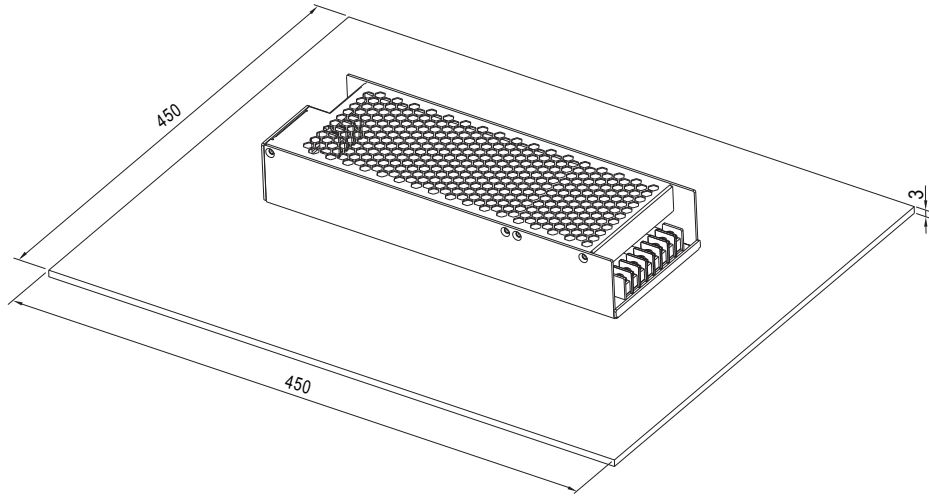

UMP-400-24/48 (Single Output):

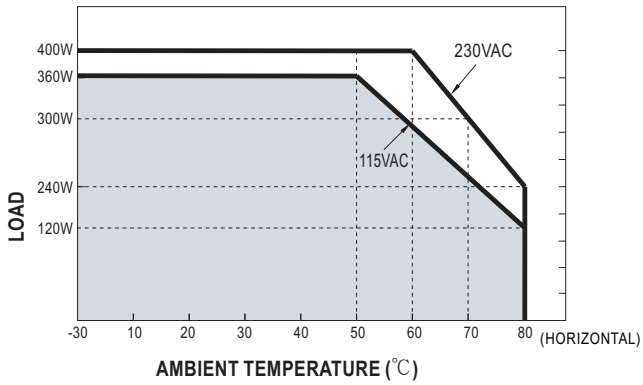

UMP-400-24/48XXX (Multi-channels):

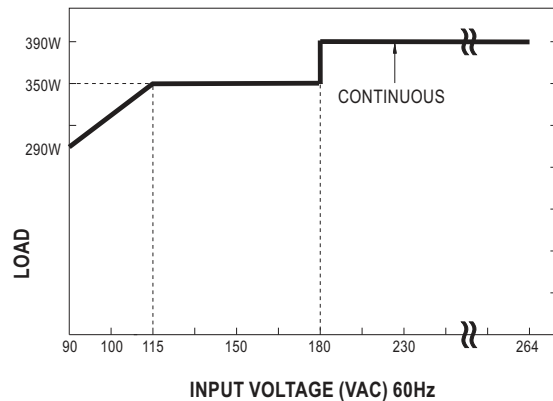
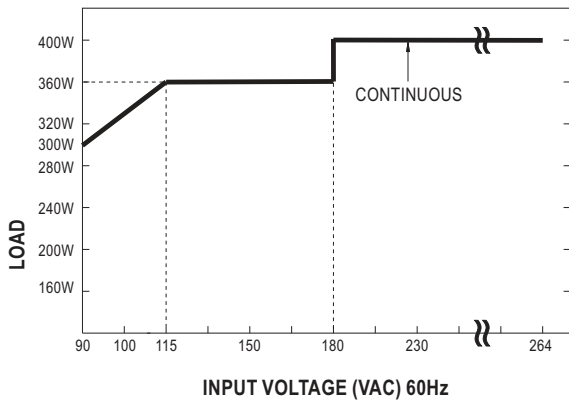
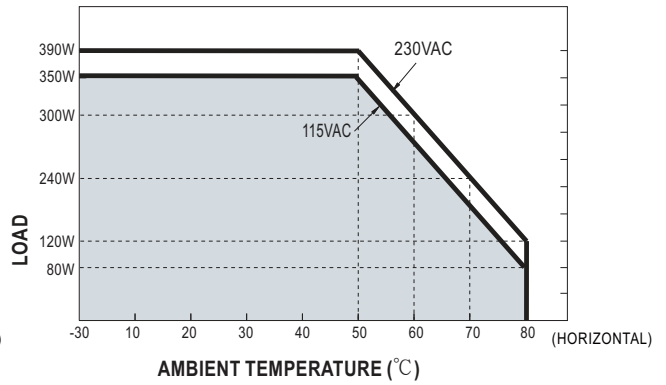

MECHANICAL SPECIFICATION

Case No.274 Unit:mm

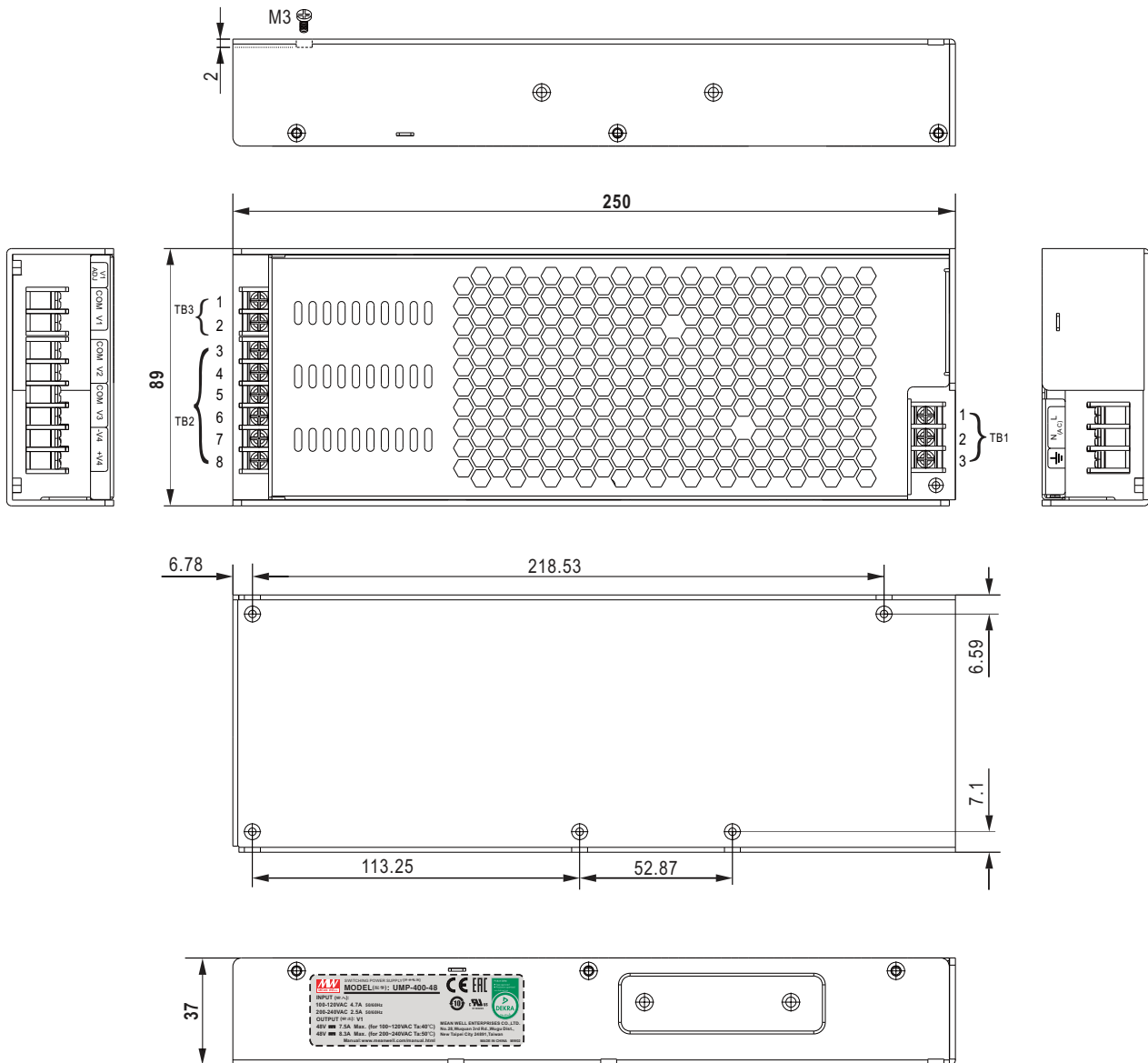

Terminal Pin No. Assignment

TB1

| Pin No. | Assignment | Screw Size | Maximum mounting torque |
|---------|------------|------------|-------------------------|
| 1 | AC/L | M3 | 14Kgf-cm |
| 2 | AC/N | | |
| 3 | FG \perp | | |

TB3 (Single output UMP-400-24/48)

| Pin No. | Assignment | Screw Size | Maximum mounting torque |
|---------|------------|------------|-------------------------|
| 1 | COM | M3 | 14Kgf-cm |
| 2 | +V1 | | |

TB2 (Multi-Channels UMP-400-24/48XXX)

| Pin No. | Assignment | Screw Size | Maximum mounting torque |
|---------|------------|------------|-------------------------|
| 3 | COM | M3 | 14Kgf-cm |
| 4 | +V2 | | |
| 5 | COM | | |
| 6 | +V3 | | |

| Pin No. | positive voltage | negative voltage | Screw Size | Maximum mounting torque |
|---------|------------------|------------------|------------|-------------------------|
| 7 | COM | -V4 | M3 | 14Kgf-cm |
| 8 | +V4 | COM | | |

NOTE:

1. Only output channel 4(V4) may be configured as negative voltage.
2. When V4 is configured as positive output, Pin7 of TB2 is the common ground reference(COM).
When V4 is configured as negative voltage, Pin8 of TB2 is the common ground reference(COM).
3. TB2 is installed only when multiple output sets are selected.

■ Installation Instruction

For heat dissipation, at least 5cm installation clearance keep-out area around the PSU should be kept and the top side must be face up, shown as below:

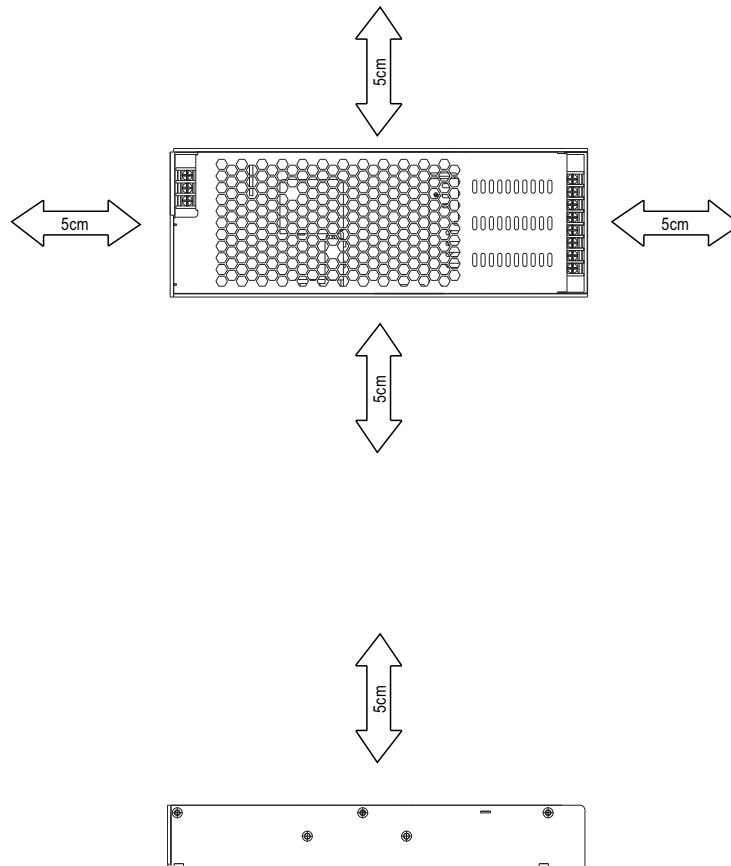
**■ Installation Manual**

Please refer to : <http://www.meanwell.com/manual.html>