

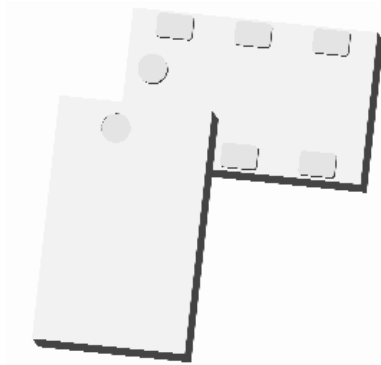

**Ultra Low Profile 0805 Power Divider Ultra Low
50Ω to 50Ω**



Description:

The PD0922J5050S2HF is a low profile, sub-miniature Wilkinson power divider in an easy to use surface mount package. The PD0922J5050S2HF is ideal for high volume manufacturing and delivers higher performances than traditional printed and lumped element solutions. The PD0922J5050S2HF is matched to 50 Ω and has a height profile of 0.5 mm which is ideal for high level integrations in the following markets: DVB-S, DVB-H (USA), GSM, DCS, PCS, CDMA, 3G and GPS. The PD0922J5050S2HF does not include the resistive element and therefore, requires an external resistor for operation. The PD0922J5050S2HF is available on tape and reel for high volume manufacturing pick and place

Detailed Electrical Specifications:

Specifications subject to change without notice.

Features:	Parameter	ROOM (25°C)			Unit
		Min.	Typ.	Max	
<ul style="list-style-type: none"> • 950-2150 MHz • 10dB Isolation (output ports) • High Return Loss • 0.5mm Height Profile • 50Ω Input / 50Ω Outputs • Low Insertion Loss • Surface Mountable • Tape & Reel • Non-conductive Surface • RoHS Compliant • External resistor required • Halogen Free 	Frequency	950		2150	MHz
	Input Port Impedance		50		Ω
	Output Port Impedance		50		Ω
	Return Loss	10.4	12		dB
	Insertion Loss*		0.5	0.8	dB
	Amplitude Balance		0.1	0.3	dB
	Phase Balance		1	3	Degrees
	Isolation (Output Ports)	9	10		dB
	Power Handling@85°C			2	Watts
	Power Handling@105°C			1.2	Watts
	Operating Temperature		-55		+140

* Insertion Loss stated at room temperature (Insertion Loss is approximately 0.1 dB higher at +85 °C) Outline Drawing

Outline Drawing:

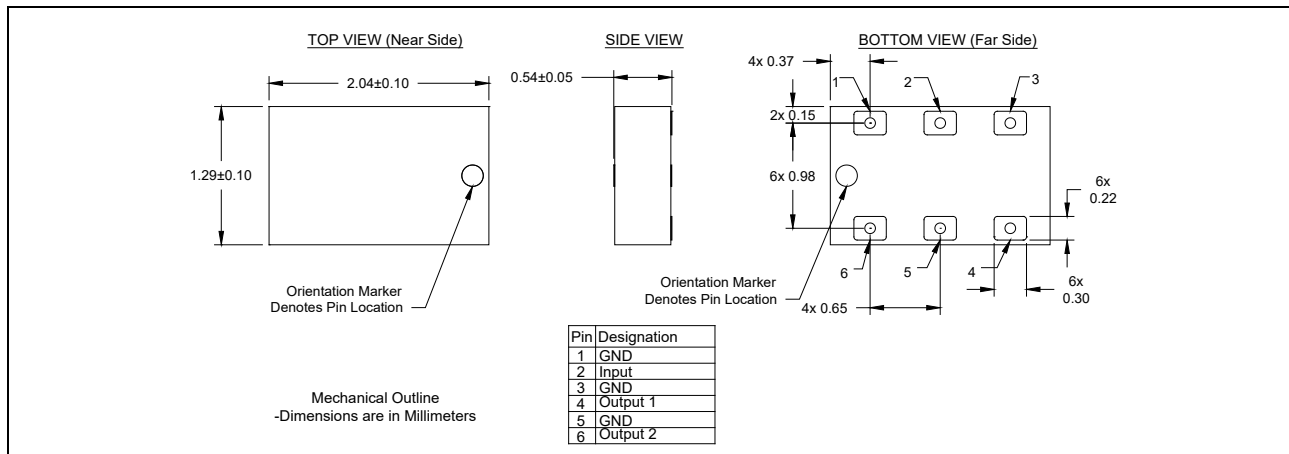

Typical Broadband Performance: 500 MHz. to 6.0 GHz.

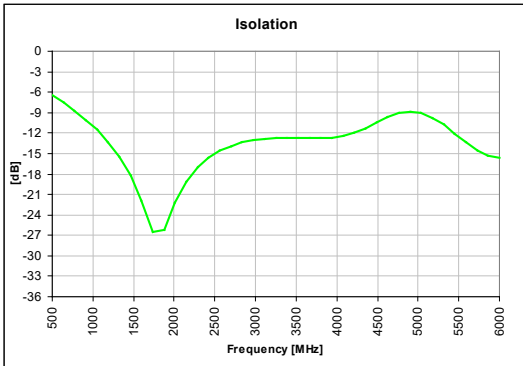
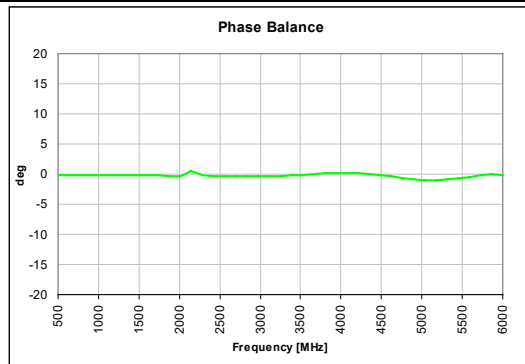
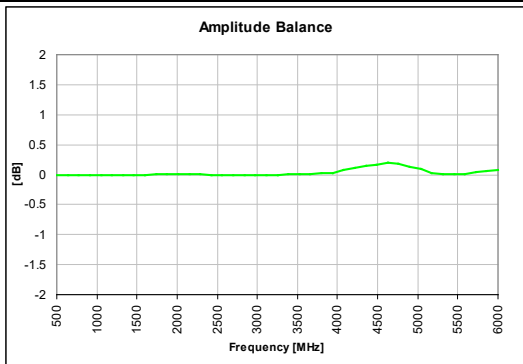
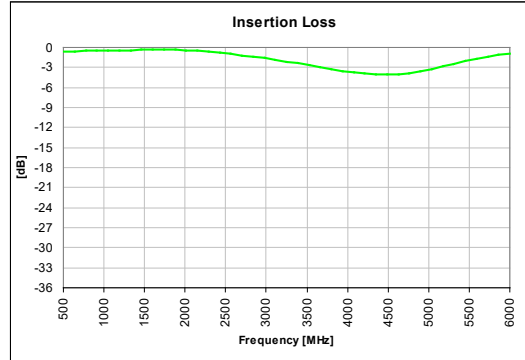
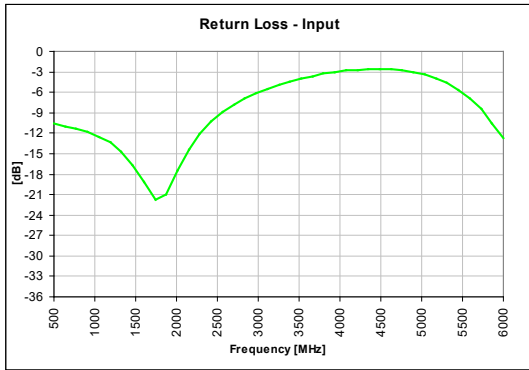

Typical Performance: 600 MHz. to 2600 MHz.

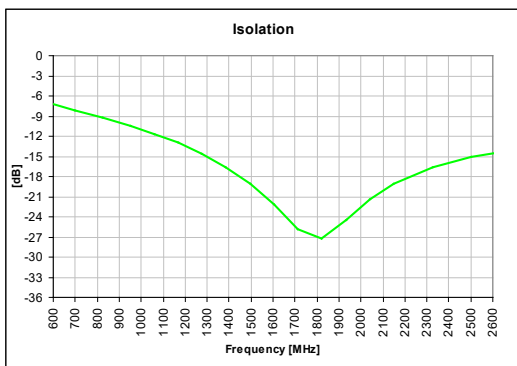
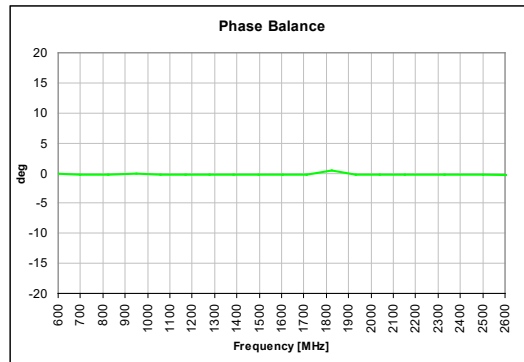
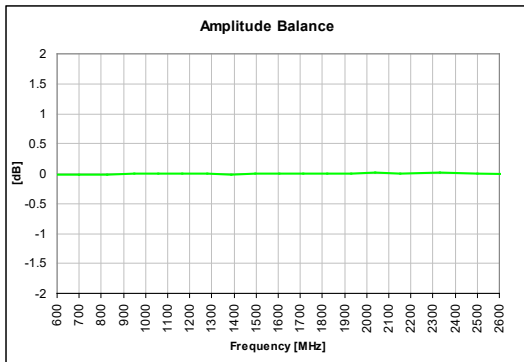
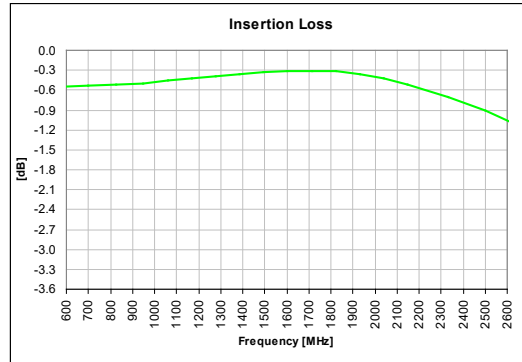
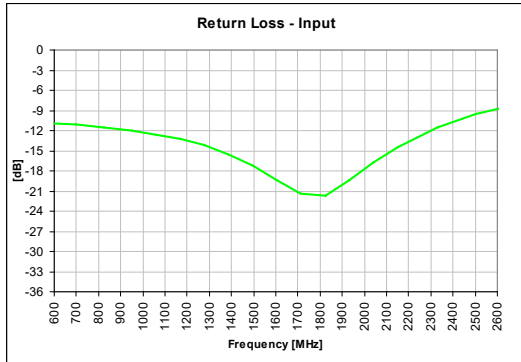

Mounting Configuration:

In order for Xinger surface mount components to work optimally, the proper impedance transmission lines must be used to connect to the RF ports. If this condition is not satisfied, insertion loss, Isolation and VSWR may not meet published specifications.

An example of the PCB footprint used in the testing of these parts is shown below. In specific designs, the transmission line widths need to be adjusted to the unique dielectric coefficients and thicknesses as well as varying pick and place equipment tolerances. In addition, since the PD0922J5050S2HF is a Wilkinson power divider, an external 0603 100Ω resistor must be mounted in locations R1 as shown in the Figure below.

All of the Xinger components are constructed from ceramic filled PTFE composites which possess excellent electrical and mechanical stability having X and Y thermal coefficient of expansion (CTE) of 17 ppm/oC.

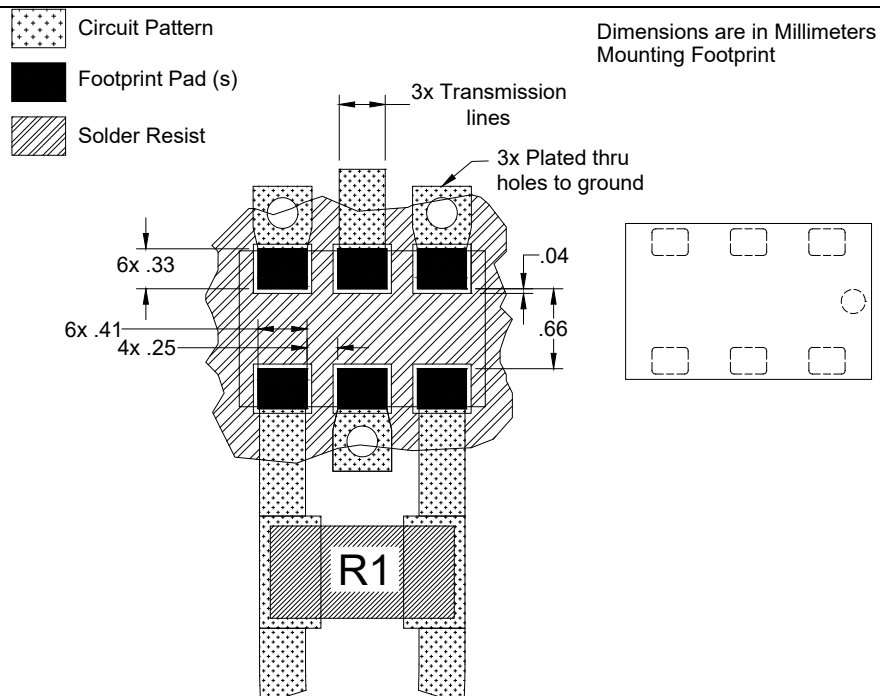

Packaging and Ordering Information:

Parts are available in reels and are packaged per EIA 481-2. Parts are oriented in tape and reel as shown below. Minimum order quantities are 4000 per reel. See Model Numbers below for further ordering information.

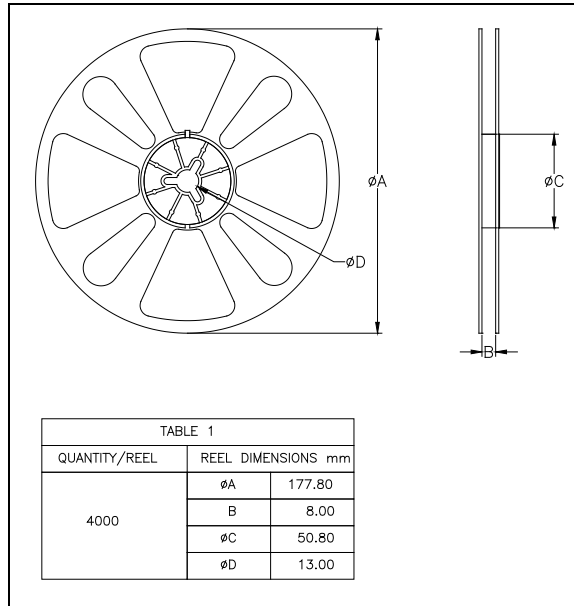
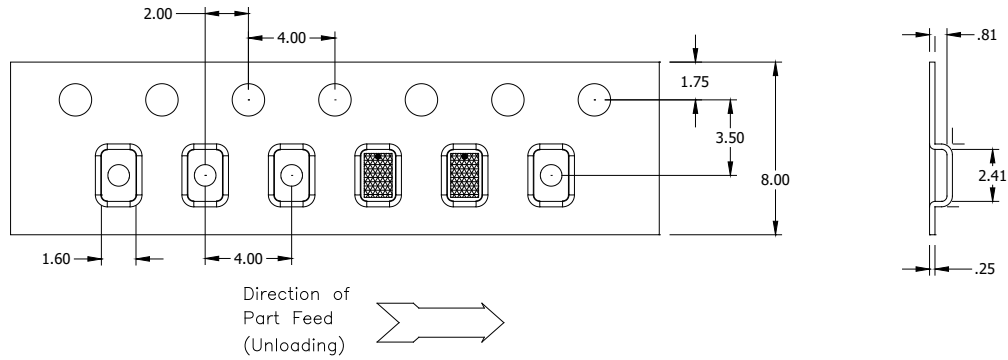

Contact us:
rf&s_support@ttm.com