

# Breakover Diode Gen<sup>1</sup> (BOD1)

 $V_{BO} = 600-1000 \text{ V}$   
 $I_{AVM} = 0.9 \text{ A}$ 

$V_{BO}$ [V]	Standard Types
600 ±50	IXBOD1-06
700 ±50	IXBOD1-07
800 ±50	IXBOD1-08
900 ±50	IXBOD1-09
1000 ±50	IXBOD1-10

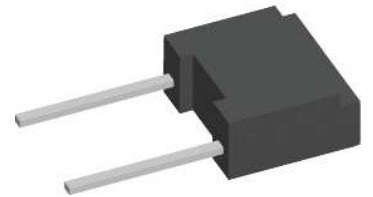

Backside: isolated



### Features / Advantages:

- Fast turn on
- Low temperature dependance
- Low leakage current

### Applications:

- High voltage circuit protection
- Transient voltage protection
- Trigger device
- Power pulse generators
- Lightning and arcing protection
- Energy discharge circuits
- Battery overvoltage protection
- Solar array protection

### Package: FP-Case

- Industry standard outline
- RoHS compliant
- Epoxy meets UL 94V-0
- Soldering pins for PCB mounting
- Base plate: Plastic overmolded tab
- Reduced weight

### Disclaimer Notice

Information furnished is believed to be accurate and reliable. However, users should independently evaluate the suitability of and test each product selected for their own applications. Littelfuse products are not designed for, and may not be used in, all applications. Read complete Disclaimer Notice at [www.littelfuse.com/disclaimer-electronics](http://www.littelfuse.com/disclaimer-electronics).



BOD1				Ratings			
Symbol	Definitions	Conditions	min.	typ.	max.		
$I_D$	drain current	$V_D = 0.8 \cdot V_{BO}$ <span style="float:right"><math>T_{VJ} = 125^\circ\text{C}</math></span>			20	$\mu\text{A}$	
$V_{BO}$	breakover voltage	$V_{BO}(T_{VJ}) = V_{BO,25^\circ\text{C}} [1 + K_T (T_{VJ} - 25^\circ\text{C})]$				V	
$I_{RMS}$	RMS current	$f = 50 \text{ Hz}$ <span style="float:right"><math>T_{amb} = 50^\circ\text{C}</math></span> pins soldered to printed circuit (conductor 0.035x2mm)			1.4	A	
$I_{FAVM}$	maximum average forward current				0.9	A	
$I_{SM}$	maximum pulsed source current	$t_p = 0.1 \text{ ms}$ ; non repetitive <span style="float:right"><math>T_{amb} = 50^\circ\text{C}</math></span>			200	A	
$I^2t$	$I^2t$ value for fusing	$t_p = 0.1 \text{ ms}$ <span style="float:right"><math>T_{amb} = 50^\circ\text{C}</math></span>			2	$\text{A}^2\text{s}$	
$K_T$	temperature coefficient of $V_{BO}$				$2 \cdot 10^{-3}$	$\text{K}^{-1}$	
$K_P$	coefficient for energy per pulse EP (material constant)				700	K/Ws	
$R_{thJA}$	thermal resistance junction to ambient	natural convection with air speed 2 m/s			60 45	K/W K/W	
$I_{BO}$	breakover current				15	mA	
$I_H$	holding current				30	mA	
$V_H$	holding voltage		4		8	V	
$(dv/dt)_{cr}$	critical rate of rise of voltage	$V_D = 0.67 \cdot (V_{BO} + 100 \text{ V})$ <span style="float:right"><math>T_{VJ} = 50^\circ\text{C}</math></span>			1000	$\text{V}/\mu\text{s}$	
$(di/dt)_{cr}$	critical rate of rise of current	$V_D = V_{BO}$ ; $I_T = 80 \text{ A}$ ; $f = 50 \text{ Hz}$ <span style="float:right"><math>T_{VJ} = 125^\circ\text{C}</math></span>			200	$\text{A}/\mu\text{s}$	
$t_q$	turn-off time	$V_D = 0.67 \cdot V_{BO}$ ; $V_R = 0 \text{ V}$ ; $I_T = 80 \text{ A}$ <span style="float:right"><math>T_{VJ} = 125^\circ\text{C}</math></span> $dv/dt_{(lin.)} = 200 \text{ V}/\mu\text{s}$ ; $di/dt = -10 \text{ A}/\mu\text{s}$		150		$\mu\text{s}$	
$V_T$	forward voltage drop	$I_T = 5 \text{ A}$ <span style="float:right"><math>T_{VJ} = 125^\circ\text{C}</math></span>			1.7	V	
$V_{T0}$	threshold voltage	for power-loss calculation only <span style="float:right"><math>T_{VJ} = 125^\circ\text{C}</math></span>			1.1	V	
$r_T$	slope resistance				0.12	$\Omega$	

Package FP-Case			Ratings			
Symbol	Definitions	Conditions	min.	typ.	max.	
T <sub>amb</sub>	ambient temperature (cooling medium)		-40		125	°C
T <sub>stg</sub>	storage temperature		-40		125	°C
T <sub>vJM</sub>	maximum virtual junction temperature		-40		125	°C
<b>Weight</b>				0.9		g

### Product Marking

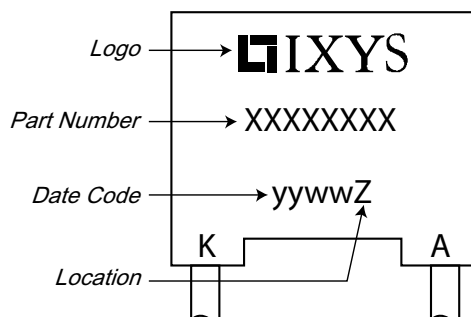

Ordering	Part Name	Marking on Product	Delivering Mode	Base Qty	Ordering Code
Standard	IXBOD1-06	IXBOD1-06	Box	100	467936
Standard	IXBOD1-07	IXBOD1-07	Box	100	478873
Standard	IXBOD1-08	IXBOD1-08	Box	100	467928
Standard	IXBOD1-09	IXBOD1-09	Box	100	474940
Standard	IXBOD1-10	IXBOD1-10	Box	100	467839

Outlines FP-case

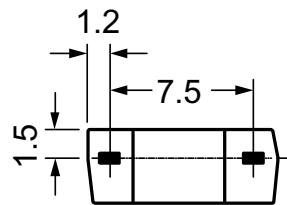
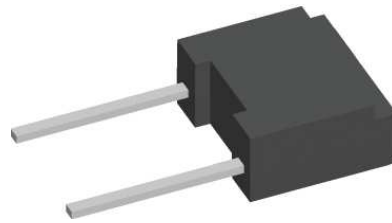

Dimensions in mm  
(1 mm = 0.0394")

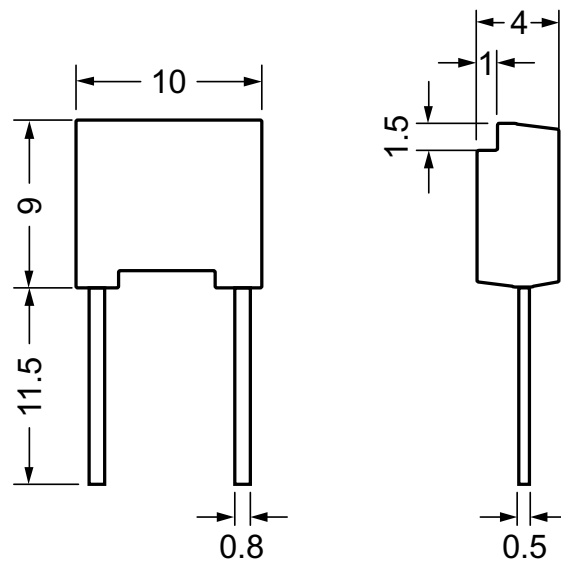

**Diode**

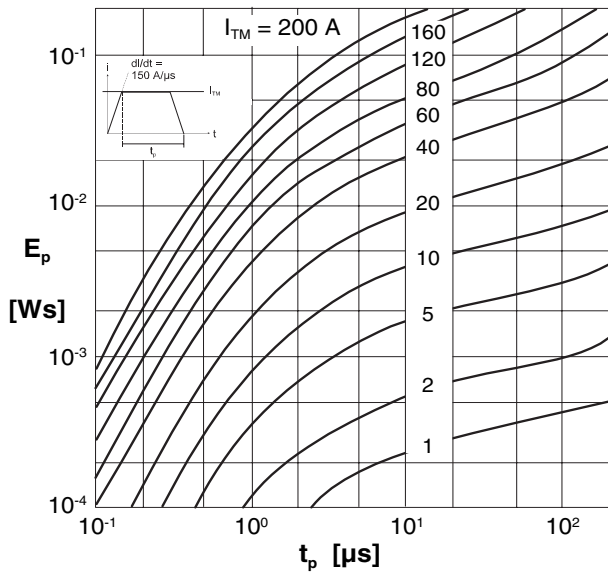

Fig. 1 Energy per pulse for trapezoidal current waveforms (see waveform definition)

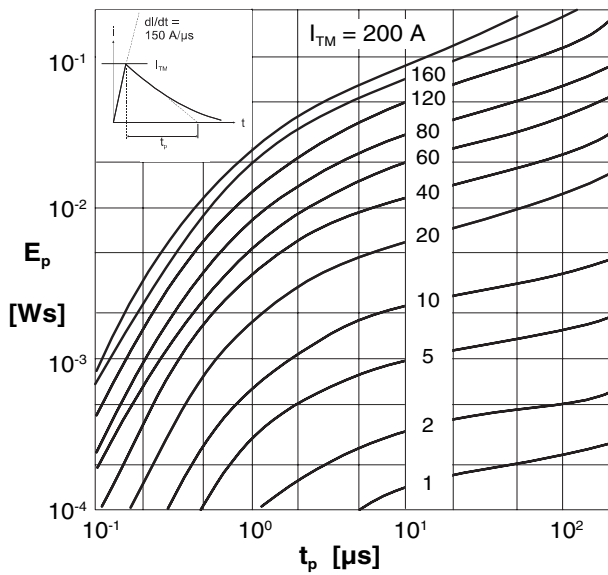

Fig. 2 Energy per pulse for exponentially decaying current pulse (see waveform definition)

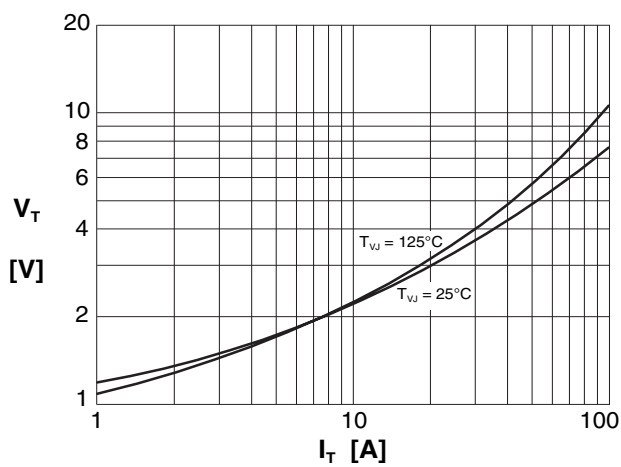

Fig. 3 On-state voltage

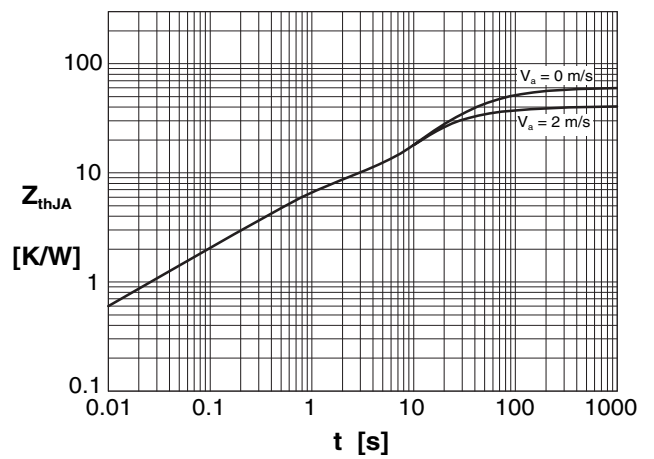

Fig. 4 Transient thermal resistance