

THESE DRAWINGS ARE THE PROPERTY OF QUALTEK ELECTRONICS AND NOT TO BE REPRODUCED FOR OR COMMUNICATED TO A THIRD PARTY WITHOUT THE EXPRESS WRITTEN PERMISSION OF AN OFFICER OF QUALTEK ELECTRONICS.

REVISION			
REV.	DESCRIPTION	DATE	APPROVED

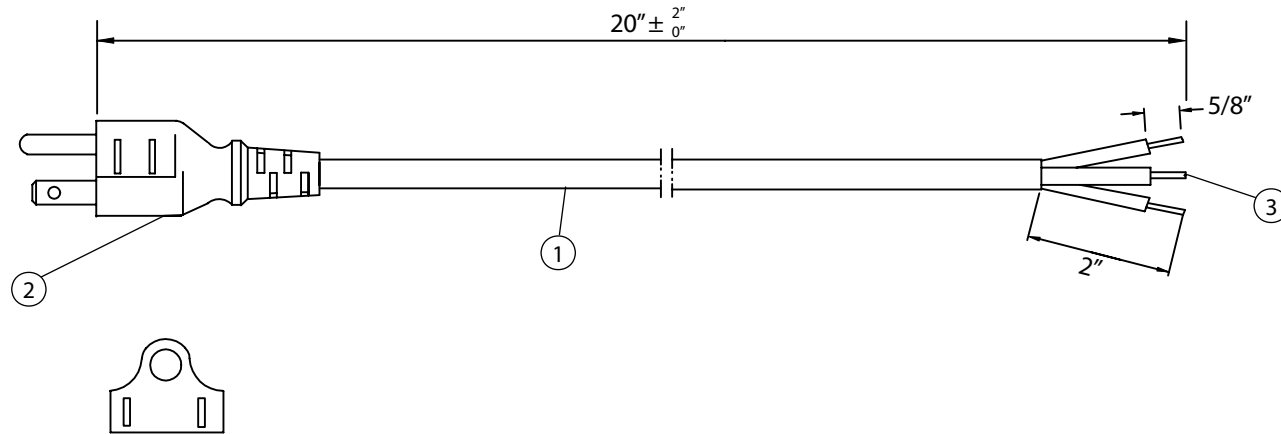

**CONTROLLED**

NOTES:

1. CORDAGE: SVT, 18AWG / 3C, UNSHIELDED, CEE COLOR CODE, TEMP. RATING: 60°C, RATING: 125V 10A, JACKET COLOR: BLACK
2. PLUG: NEMA 5-15P
3. OTHER END: ROJ 2", STRIP 5/8"
4. APPROVALS: UL, CSA
5. ROHS COMPLIANT

Dim range (mm)	Tolerance +/- (mm)	Qualtek Electronics Corp. PPC DIVISION		
0-1	0.15	Part Number:	311327-01	
1-6	0.20	Description:	POWER CORD	
6-18	0.30		UNIT: in	
18-50	0.50	Drawn / Date	Checked / Date	Approved / Date
50-120	0.70	R. Nuti 07-20-17	07-20-17	LY / 07-20-17
120-250	0.90			
250-500	1.20			