

Amplifier Transistors

MAXIMUM RATINGS

Rating	Symbol	MPS8098 MPS8598	MPS8099 MPS8599	Unit
Collector–Emitter Voltage	V_{CE0}	60	80	Vdc
Collector–Base Voltage	V_{CB0}	60	80	Vdc
Emitter–Base Voltage	V_{EB0}	6.0	5.0	Vdc
Collector Current – Continuous	I_C	500		mAdc
Total Device Dissipation @ $T_A = 25^\circ\text{C}$ Derate above 25°C	P_D	625	5.0	mW mW/°C
Total Device Dissipation @ $T_C = 25^\circ\text{C}$ Derate above 25°C	P_D	1.5	12	Watts mW/°C
Operating and Storage Junction Temperature Range	T_J, T_{stg}	–55 to +150		°C

THERMAL CHARACTERISTICS

Characteristic	Symbol	Max	Unit
Thermal Resistance, Junction to Ambient	$R_{\theta JA}$	200	°C/W
Thermal Resistance, Junction to Case	$R_{\theta JC}$	83.3	°C/W

NPN
MPS8098
MPS8099*
PNP
MPS8598
MPS8599*

Voltage and current are negative
for PNP transistors

*ON Semiconductor Preferred Device

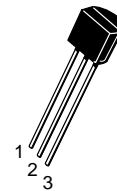

CASE 29–11, STYLE 1
TO–92 (TO–226AA)

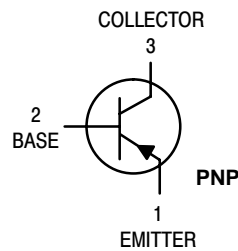
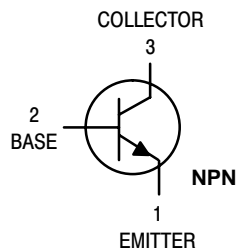

Preferred devices are ON Semiconductor recommended choices for future use and best overall value.

NPN MPS8098 MPS8099 PNP MPS8598 MPS8599

ELECTRICAL CHARACTERISTICS (T_A = 25°C unless otherwise noted)

Characteristic		Symbol	Min	Max	Unit
OFF CHARACTERISTICS					
Collector–Emitter Breakdown Voltage ⁽¹⁾ (I _C = 10 mA _{dc} , I _B = 0)	MPS8098, MPS8598 MPS8099, MPS8599	V _{(BR)CEO}	60 80	— —	V _{dc}
Collector–Base Breakdown Voltage (I _C = 100 μA _{dc} , I _E = 0)	MPS8098, MPS8598 MPS8099, MPS8599	V _{(BR)CBO}	60 80	— —	V _{dc}
Emitter–Base Breakdown Voltage (I _E = 10 μA _{dc} , I _C = 0)	MPS8098, MPS8099 MPS8598, MPS8599	V _{(BR)EBO}	6.0 5.0	— —	V _{dc}
Collector Cutoff Current (V _{CE} = 60 V _{dc} , I _B = 0)		I _{CES}	—	0.1	μA _{dc}
Collector Cutoff Current (V _{CB} = 60 V _{dc} , I _E = 0) (V _{CB} = 80 V _{dc} , I _E = 0)	MPS8098, MPS8598 MPS8099, MPS8599	I _{CBO}	— —	0.1 0.1	μA _{dc}
Emitter Cutoff Current (V _{EB} = 6.0 V _{dc} , I _C = 0) (V _{EB} = 4.0 V _{dc} , I _C = 0)	MPS8098, MPS8099 MPS8598, MPS8599	I _{EBO}	— —	0.1 0.1	μA _{dc}

1. Pulse Test: Pulse Width ≤ 300 μs, Duty Cycle = 2.0%.

ON CHARACTERISTICS⁽¹⁾

DC Current Gain (I _C = 1.0 mA _{dc} , V _{CE} = 5.0 V _{dc}) (I _C = 10 mA _{dc} , V _{CE} = 5.0 V _{dc}) (I _C = 100 mA _{dc} , V _{CE} = 5.0 V _{dc})		h _{FE}	100 100 75	300 — —	—
Collector–Emitter Saturation Voltage (I _C = 100 mA _{dc} , I _B = 5.0 mA _{dc}) (I _C = 100 mA _{dc} , I _B = 10 mA _{dc})		V _{CE(sat)}	— —	0.4 0.3	V _{dc}
Base–Emitter On Voltage (I _C = 1.0 mA _{dc} , V _{CE} = 5.0 V _{dc}) (I _C = 10 mA _{dc} , V _{CE} = 5.0 V _{dc})	MPS8098, MPS8598 MPS8099, MPS8599	V _{BE(on)}	0.5 0.6	0.7 0.8	V _{dc}

SMALL–SIGNAL CHARACTERISTICS

Current–Gain — Bandwidth Product (I _C = 10 mA _{dc} , V _{CE} = 5.0 V _{dc} , f = 100 MHz)		f _T	150	—	MHz
Output Capacitance (V _{CB} = 5.0 V _{dc} , I _E = 0, f = 1.0 MHz)	MPS8098, MPS8099 MPS8598, MPS8599	C _{obo}	— —	6.0 8.0	pF
Input Capacitance (V _{EB} = 0.5 V _{dc} , I _C = 0, f = 1.0 MHz)	MPS8098, MPS8099 MPS8598, MPS8599	C _{ibo}	— —	25 30	pF

1. Pulse Test: Pulse Width ≤ 300 μs, Duty Cycle = 2.0%.

NPN MPS8098 MPS8099 PNP MPS8598 MPS8599

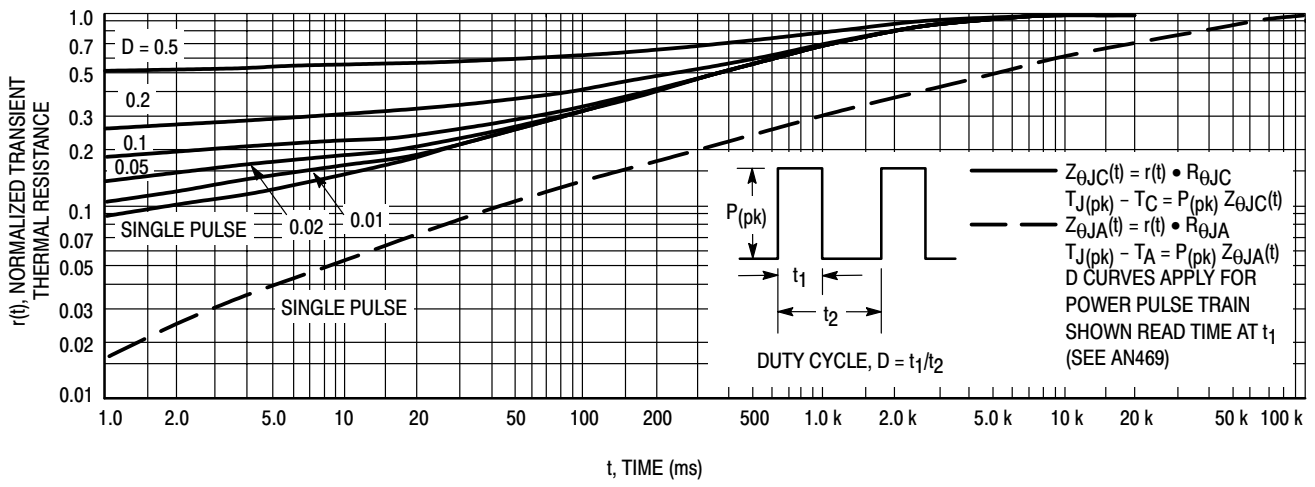
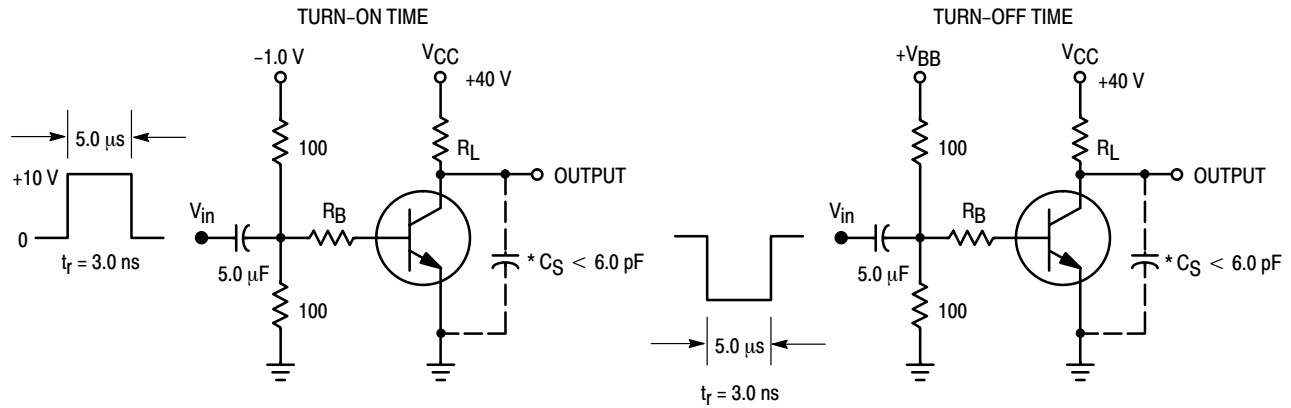

Figure 1. MPS8098, MPS8099, MPS8598 and MPS8599 Thermal Response



*Total Shunt Capacitance of Test Jig and Connectors
For PNP Test Circuits, Reverse All Voltage Polarities

Figure 2. Switching Time Test Circuits

NPN MPS8098 MPS8099 PNP MPS8598 MPS8599

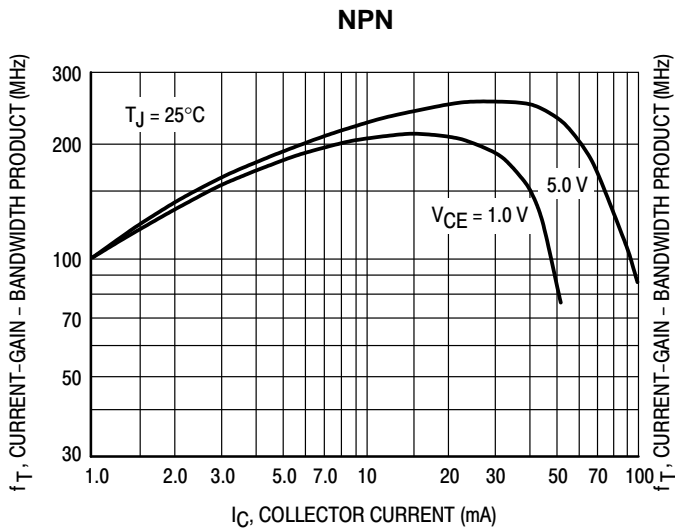

Figure 3. MPS8098/99 Current-Gain — Bandwidth Product

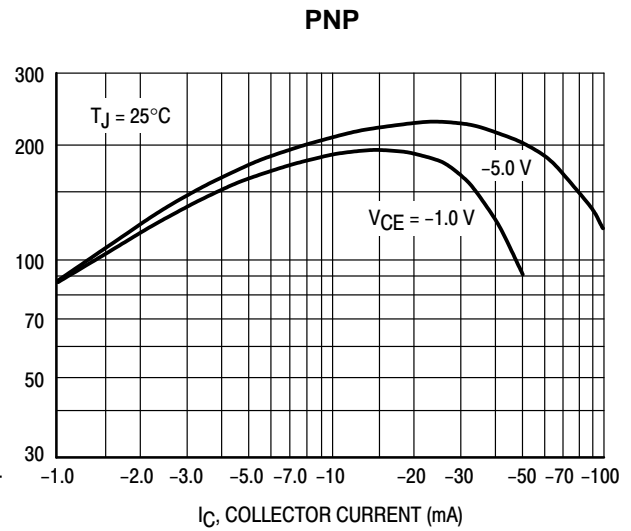

Figure 4. MPS8598/99 Current-Gain — Bandwidth Product

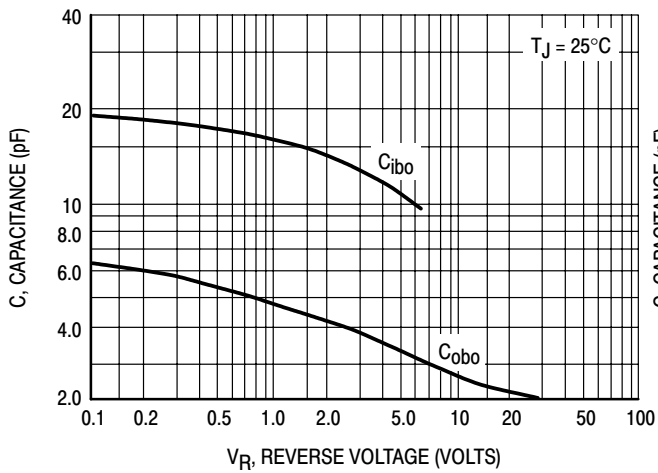

Figure 5. MPS8098/99 Capacitance

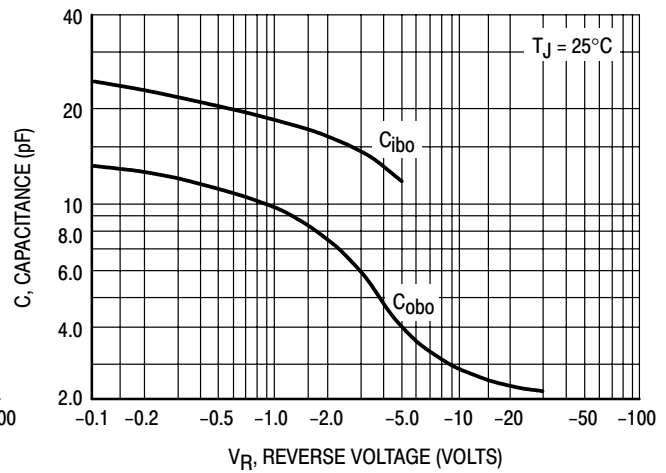

Figure 6. MPS8598/99 Capacitance

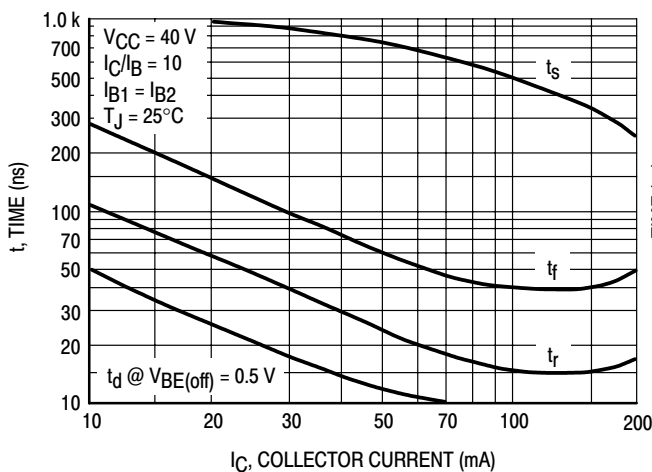

Figure 7. MPS8098/99 Switching Times

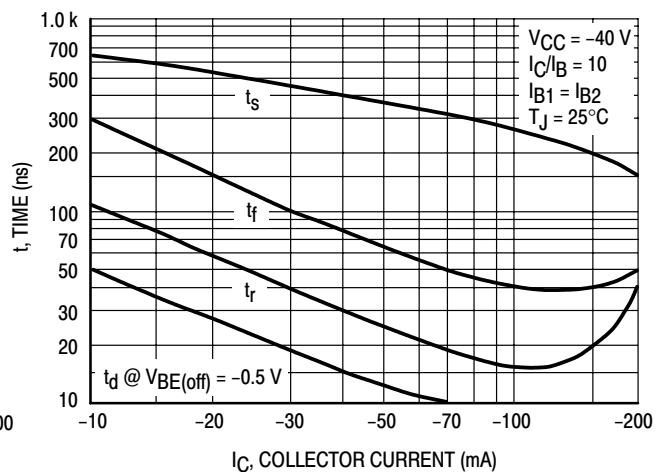

Figure 8. MPS8598/99 Switching Times

NPN MPS8098 MPS8099 PNP MPS8598 MPS8599

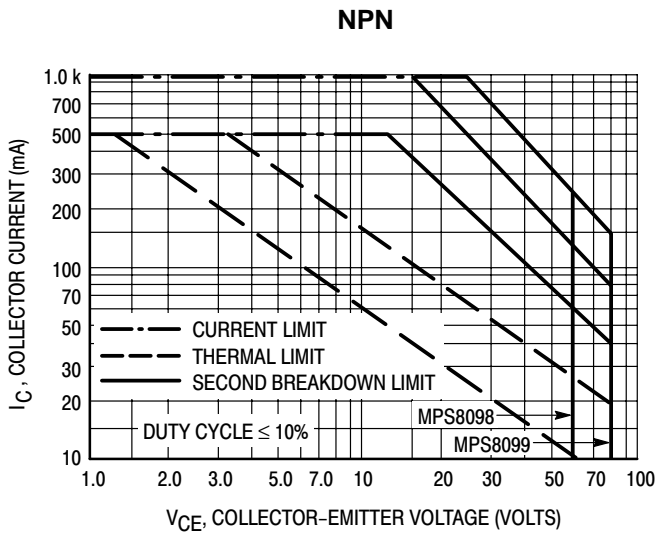

Figure 9. MPS8098/99 Active-Region Safe Operating Area

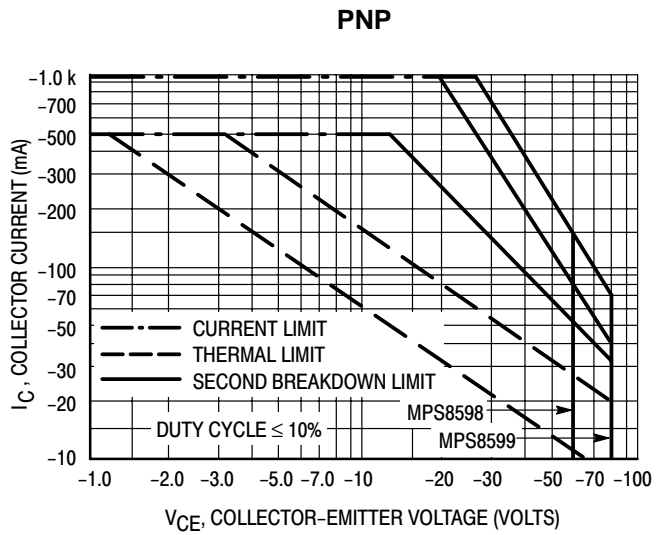

Figure 10. MPS8598/99 Active-Region Safe Operating Area

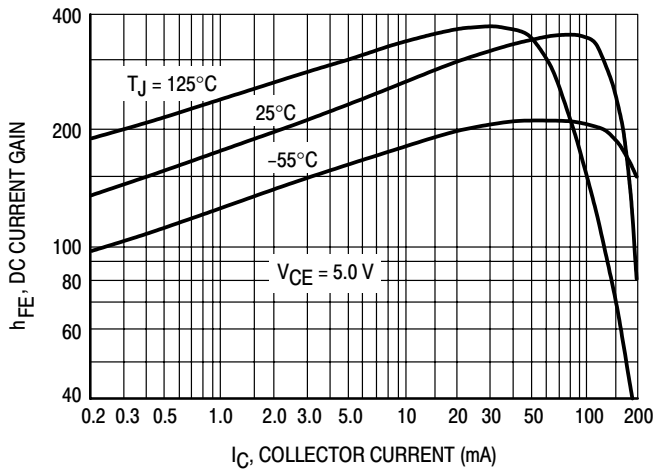

Figure 11. MPS8098/99 DC Current Gain

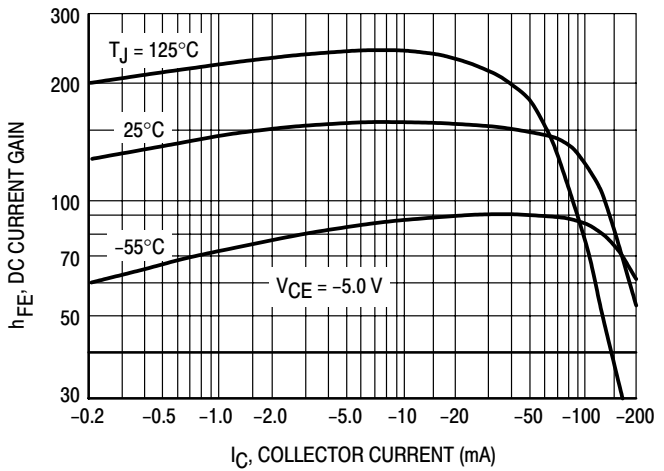

Figure 12. MPS8598/99 DC Current Gain

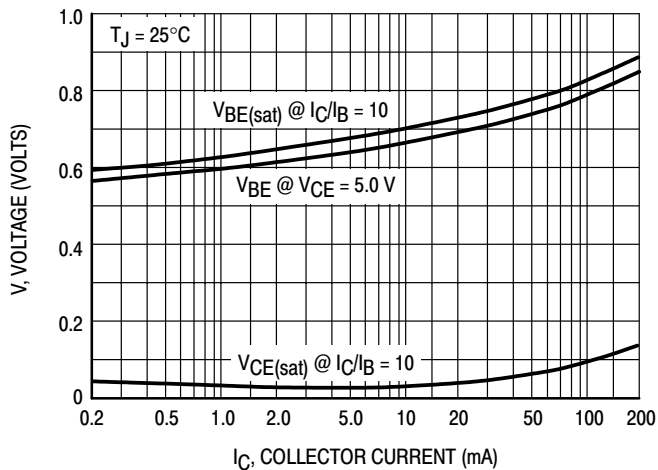

Figure 13. MPS8098/99 "ON" Voltages

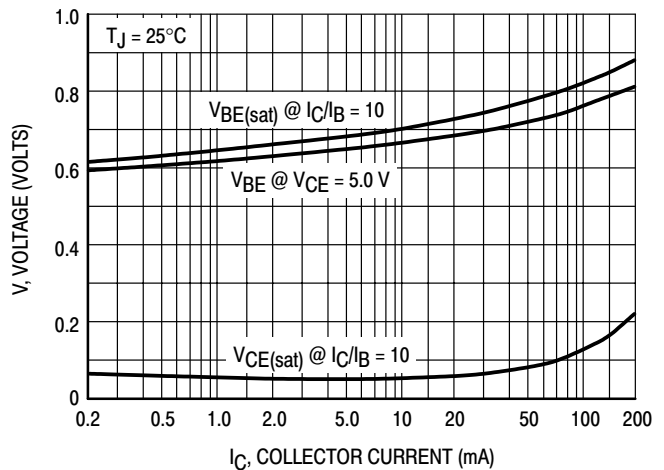

Figure 14. MPS8598/99 "ON" Voltages

NPN MPS8098 MPS8099 PNP MPS8598 MPS8599

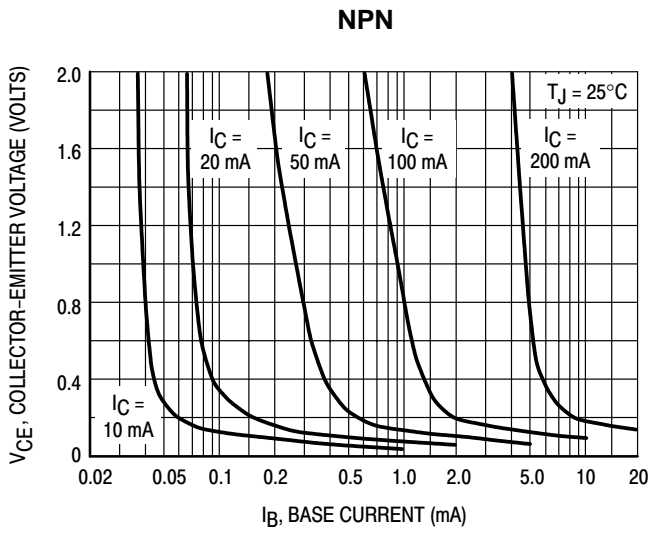

Figure 15. MPS8098/99 Collector Saturation Region

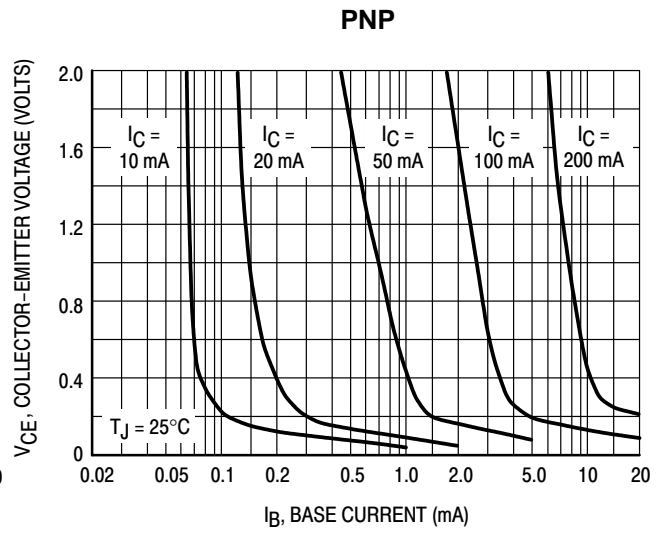

Figure 16. MPS8598/99 Collector Saturation Region

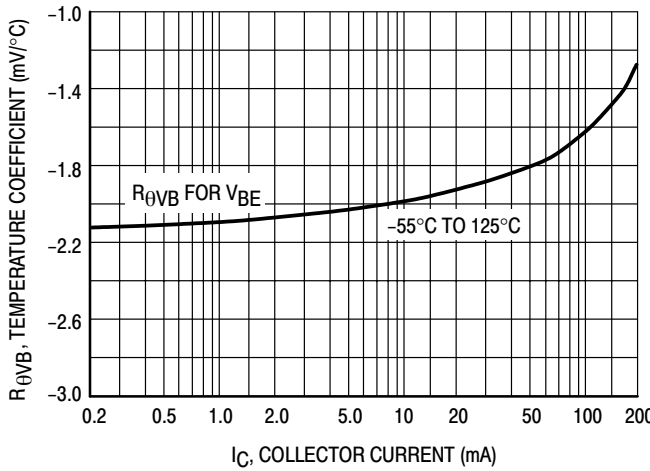

Figure 17. MPS8098/99 Base-Emitter Temperature Coefficient

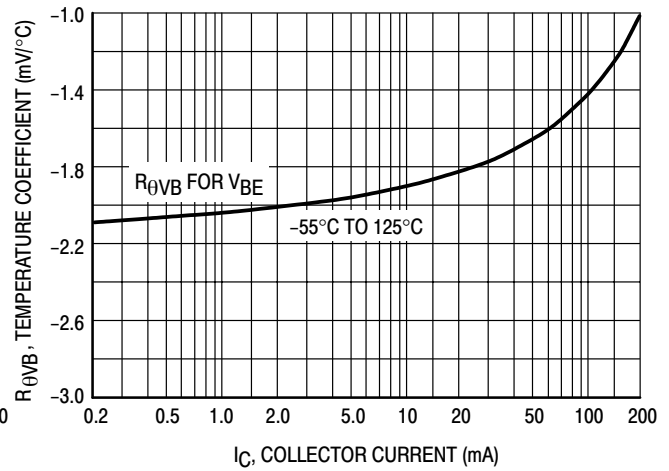
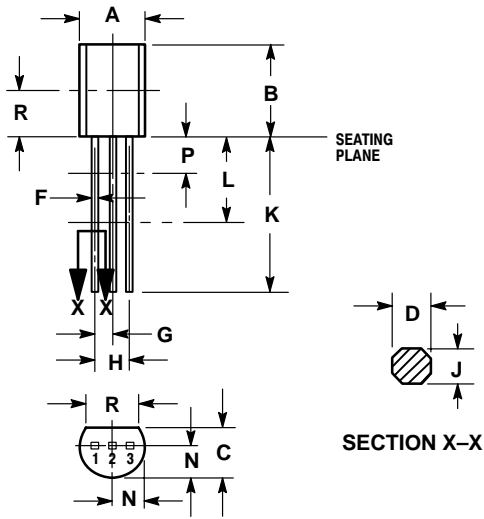

Figure 18. MPS8598/99 Base-Emitter Temperature Coefficient

NPN MPS8098 MPS8099 PNP MPS8598 MPS8599

PACKAGE DIMENSIONS

CASE 029-11
(TO-226AA)
ISSUE AD



NOTES:

1. DIMENSIONING AND TOLERANCING PER ANSI Y14.5M, 1982.
2. CONTROLLING DIMENSION: INCH.
3. CONTOUR OF PACKAGE BEYOND DIMENSION R IS UNCONTROLLED.
4. DIMENSION F APPLIES BETWEEN P AND L. DIMENSIONS D AND J APPLY BETWEEN L AND K MINIMUM. LEAD DIMENSION IS UNCONTROLLED IN P AND BEYOND DIMENSION K MINIMUM.

DIM	INCHES		MILLIMETERS	
	MIN	MAX	MIN	MAX
A	0.175	0.205	4.44	5.21
B	0.290	0.310	7.37	7.87
C	0.125	0.165	3.18	4.19
D	0.018	0.021	0.457	0.533
F	0.016	0.019	0.407	0.482
G	0.045	0.055	1.15	1.39
H	0.095	0.105	2.42	2.66
J	0.018	0.024	0.46	0.61
K	0.500	---	12.70	---
L	0.250	---	6.35	---
N	0.080	0.105	2.04	2.66
P	---	0.100	---	2.54
R	0.135	---	3.43	---

- YLE 1:
PIN 1. EMITTER
2. BASE
3. COLLECTOR

NPN MPS8098 MPS8099 PNP MPS8598 MPS8599

ON Semiconductor and  are trademarks of Semiconductor Components Industries, LLC (SCILLC). SCILLC reserves the right to make changes without further notice to any products herein. SCILLC makes no warranty, representation or guarantee regarding the suitability of its products for any particular purpose, nor does SCILLC assume any liability arising out of the application or use of any product or circuit, and specifically disclaims any and all liability, including without limitation special, consequential or incidental damages. "Typical" parameters which may be provided in SCILLC data sheets and/or specifications can and do vary in different applications and actual performance may vary over time. All operating parameters, including "Typicals" must be validated for each customer application by customer's technical experts. SCILLC does not convey any license under its patent rights nor the rights of others. SCILLC products are not designed, intended, or authorized for use as components in systems intended for surgical implant into the body, or other applications intended to support or sustain life, or for any other application in which the failure of the SCILLC product could create a situation where personal injury or death may occur. Should Buyer purchase or use SCILLC products for any such unintended or unauthorized application, Buyer shall indemnify and hold SCILLC and its officers, employees, subsidiaries, affiliates, and distributors harmless against all claims, costs, damages, and expenses, and reasonable attorney fees arising out of, directly or indirectly, any claim of personal injury or death associated with such unintended or unauthorized use, even if such claim alleges that SCILLC was negligent regarding the design or manufacture of the part. SCILLC is an Equal Opportunity/Affirmative Action Employer.

PUBLICATION ORDERING INFORMATION

Literature Fulfillment:

Literature Distribution Center for ON Semiconductor
P.O. Box 5163, Denver, Colorado 80217 USA
Phone: 303-675-2175 or 800-344-3860 Toll Free USA/Canada
Fax: 303-675-2176 or 800-344-3867 Toll Free USA/Canada
Email: ONlit@hibbertco.com

N. American Technical Support: 800-282-9855 Toll Free USA/Canada

JAPAN: ON Semiconductor, Japan Customer Focus Center
4-32-1 Nishi-Gotanda, Shinagawa-ku, Tokyo, Japan 141-0031
Phone: 81-3-5740-2700
Email: r14525@onsemi.com

ON Semiconductor Website: <http://onsemi.com>

For additional information, please contact your local Sales Representative.