



## Main

Range of Product	Zelio Logic
Product or Component Type	Discrete I/O extension module

## Complementary

Number of control scheme lines	120 ladder
Cycle time	6...90 ms
Backup time	10 years 77 °F (25 °C)
Clock drift	12 min/year 32...131 °F (0...55 °C)
Checks	Program memory on each power up
[Us] rated supply voltage	100...240 V AC
Supply voltage limits	85...264 V
Supply frequency	50/60 Hz
Reverse polarity protection	With
Discrete input number	8
Discrete input voltage	100...240 V AC
Discrete input current	0.6 mA
Discrete input frequency	57...63 Hz 47...53 Hz
Voltage state 1 guaranteed	>= 79 V discrete input
Voltage state 0 guaranteed	<= 40 V discrete input
Current state 1 guaranteed	>= 0.17 mA discrete input)
Current state 0 guaranteed	<= 0.5 mA discrete input)
Input impedance	350 kOhm discrete input
Number of Outputs	6 relay
Output voltage limits	5...30 V DC relay output) 24...250 V AC
Contacts type and composition	NO relay output
Output thermal current	5 A for 2 outputs relay output 8 A for 4 outputs relay output
Electrical durability	AC-15 500000 cycles 230 V, 0.9 A relay output EN/IEC 60947-5-1 AC-12 500000 cycles 230 V, 1.5 A relay output EN/IEC 60947-5-1 DC-13 500000 cycles 24 V, 0.6 A relay output EN/IEC 60947-5-1 DC-12 500000 cycles 24 V, 1.5 A relay output EN/IEC 60947-5-1
Switching capacity in mA	>= 10 mA 12 V relay output)
Operating rate in Hz	0.1 Hz at Ie)relay output 10 Hz no load)relay output
Mechanical durability	10000000 cycles relay output
[Uimp] rated impulse withstand voltage	4 kV EN/IEC 60947-1 and EN/IEC 60664-1

Response time	50 ms ladder from state 0 to state 1)discrete input 50 ms ladder from state 1 to state 0)discrete input 50...255 ms FBD from state 0 to state 1)discrete input 50...255 ms FBD from state 1 to state 0)discrete input 10 ms from state 0 to state 1)relay output 5 ms from state 1 to state 0)relay output
Connections - terminals	Screw terminals, 1 x 0.25...1 x 2.5 mm <sup>2</sup> AWG 24...AWG 14) flexible with cable end Screw terminals, 2 x 0.25...2 x 0.75 mm <sup>2</sup> AWG 24...AWG 18) flexible with cable end Screw terminals, 1 x 0.2...1 x 2.5 mm <sup>2</sup> AWG 25...AWG 14) semi-solid Screw terminals, 1 x 0.2...1 x 2.5 mm <sup>2</sup> AWG 25...AWG 14) solid Screw terminals, 2 x 0.2...2 x 1.5 mm <sup>2</sup> AWG 24...AWG 16) solid
Tightening torque	4.43 lbf.in (0.5 N.m)
Overvoltage category	III EN/IEC 60664-1
Net Weight	0.49 lb(US) (0.22 kg)

## Environment

Product Certifications	C-tick GOST CSA GL UL
Standards	EN/IEC 61000-4-6 level 3 EN/IEC 61000-4-2 level 3 EN/IEC 61000-4-4 level 3 EN/IEC 60068-2-27 Ea EN/IEC 61000-4-5 EN/IEC 61000-4-11 EN/IEC 60068-2-6 Fc EN/IEC 61000-4-12 EN/IEC 61000-4-3
IP degree of protection	IP20 IEC 60529 terminal block) IP40 IEC 60529 front panel)
Environmental characteristic	EMC directive EN/IEC 61000-6-2 EMC directive EN/IEC 61000-6-3 EMC directive EN/IEC 61000-6-4 EMC directive EN/IEC 61131-2 zone B Low voltage directive EN/IEC 61131-2
Disturbance radiated/conducted	Class B EN 55022-11 group 1
Pollution degree	2 EN/IEC 61131-2
Ambient air temperature for operation	-4...104 °F (-20...40 °C) in non-ventilated enclosure IEC 60068-2-1 and IEC 60068-2-2 -4...131 °F (-20...55 °C) IEC 60068-2-1 and IEC 60068-2-2
Ambient Air Temperature for Storage	-40...158 °F (-40...70 °C)
Operating altitude	6561.68 ft (2000 m)
Maximum altitude transport	10000.00 ft (3048 m)
Relative Humidity	95 % without condensation or dripping water

## Ordering and shipping details





Category	22378 - SR2,3 ZELIO 2 RELAYS
Discount Schedule	I
GTIN	3389110550160
Nbr. of units in pkg.	1
Package weight(Lbs)	7.09 oz (201 g)
Returnability	Yes
Country of origin	FR

## Packing Units

Unit Type of Package 1	PCE
Package 1 Height	2.68 in (6.8 cm)
Package 1 width	3.94 in (10 cm)
Package 1 Length	3.46 in (8.8 cm)
Unit Type of Package 2	S03

Number of Units in Package 2	30
Package 2 Weight	14.45 lb(US) (6.554 kg)
Package 2 Height	11.81 in (30 cm)
Package 2 width	11.81 in (30 cm)
Package 2 Length	15.75 in (40 cm)

### Offer Sustainability

Sustainable offer status	Green Premium product
California proposition 65	WARNING: This product can expose you to chemicals including: Lead and lead compounds, which is known to the State of California to cause cancer and birth defects or other reproductive harm. For more information go to <a href="http://www.P65Warnings.ca.gov">www.P65Warnings.ca.gov</a>
REACH Regulation	 <a href="#">REACH Declaration</a>
EU RoHS Directive	Pro-active compliance (Product out of EU RoHS legal scope)  <a href="#">EU RoHS Declaration</a>
Mercury free	Yes
RoHS exemption information	 <a href="#">Yes</a>
China RoHS Regulation	 <a href="#">China RoHS Declaration</a>
Environmental Disclosure	 <a href="#">Product Environmental Profile</a>
Circularity Profile	 <a href="#">End Of Life Information</a>
WEEE	The product must be disposed on European Union markets following specific waste collection and never end up in rubbish bins.
PVC free	Yes

### Contractual warranty

Warranty	18 months
----------	-----------

I/O Extension Modules

Mounting on 35 mm/1.38 in. DIN Rail

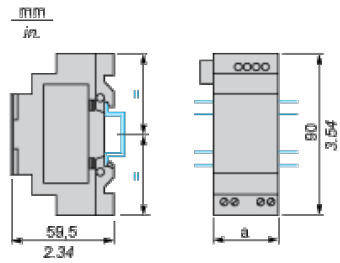

Screw Fixing (Retractable Lugs)

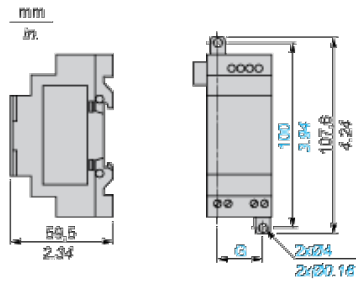

SR3	a (mm/in.)	G (mm/in.)
XT61**	35 / 1.38	25 / 0.98
XT101**	72 / 2.83	60 / 2.36
XT141**	72 / 2.83	60 / 2.36

Connection of Smart Relays on AC Supply

SR...1B, SR...1FU

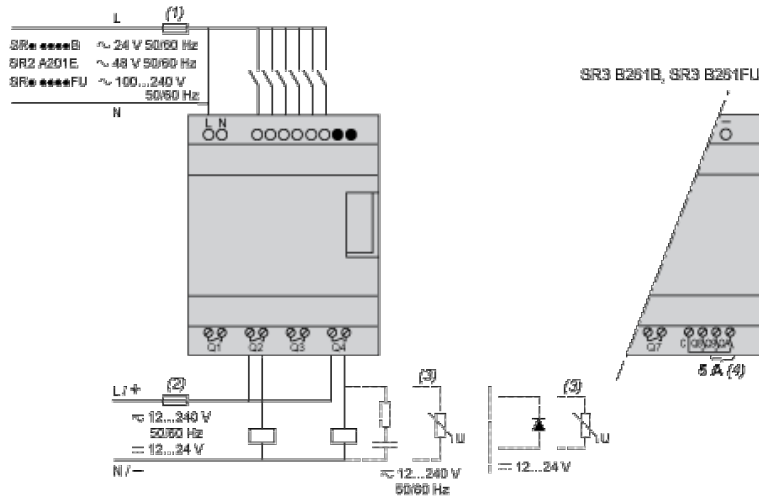

With Discrete I/O Extension Module

SR3B...B + SR3XT...B, SR3B...FU + SR3XT...FU

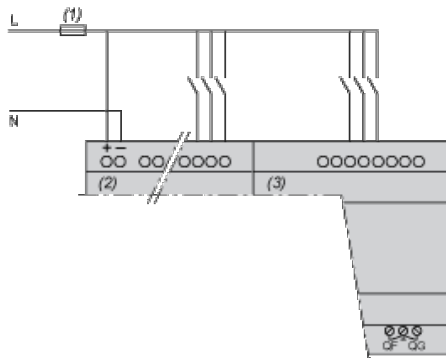

Compact and Modular Smart Relays

Electrical Durability of Relay Outputs

(in millions of operating cycles, conforming to IEC/EN 60947-5-1)

AC-12 (1)

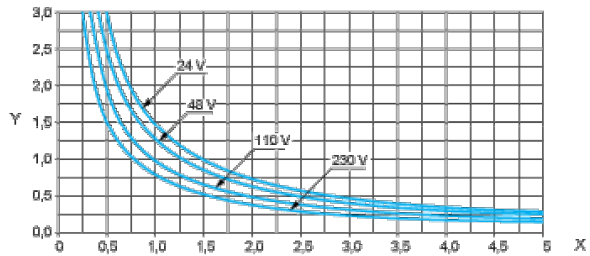

X: Current (A)

Y: Millions of operating cycles

(1) AC-12: switching resistive loads and opto-coupler isolated solid-state loads,  $\cos \geq 0.9$ .

AC-14 (1)

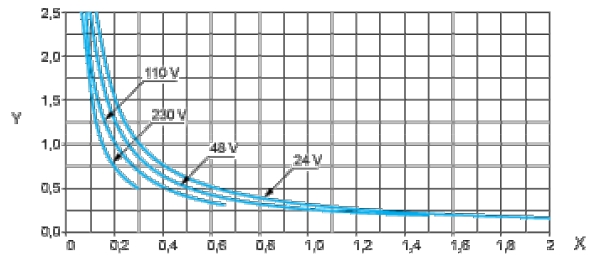

X: Current (A)

Y: Millions of operating cycles

(1) AC-14: switching small electromagnetic loads  $\leq 72$  VA, make:  $\cos = 0.3$ , break:  $\cos = 0.3$ .

AC-15 (1)

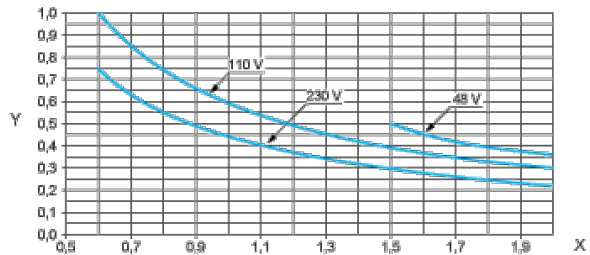

X: Current (A)

Y: Millions of operating cycles

(1) AC-15: switching electromagnetic loads  $\geq 72$  VA, make:  $\cos = 0.7$ , break:  $\cos = 0.4$ .