

PRODUCT NUMBER
SEE PART NO. TABLE

WIRE RECEPTACLE 10127716

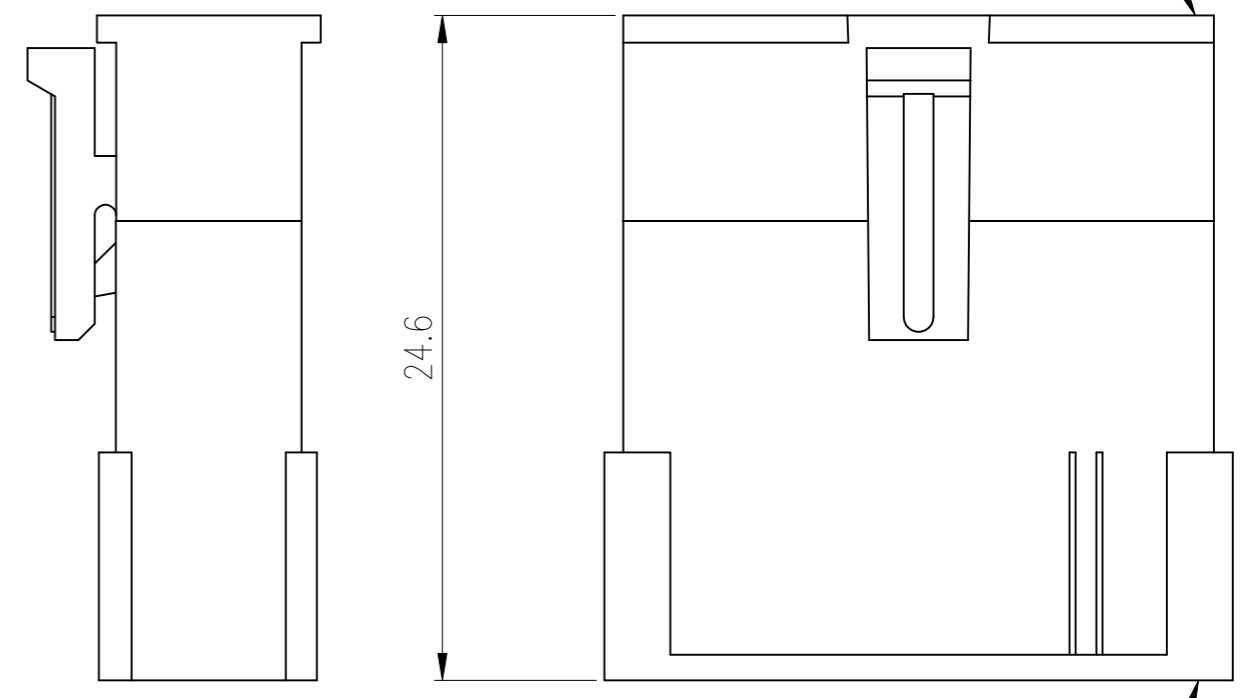
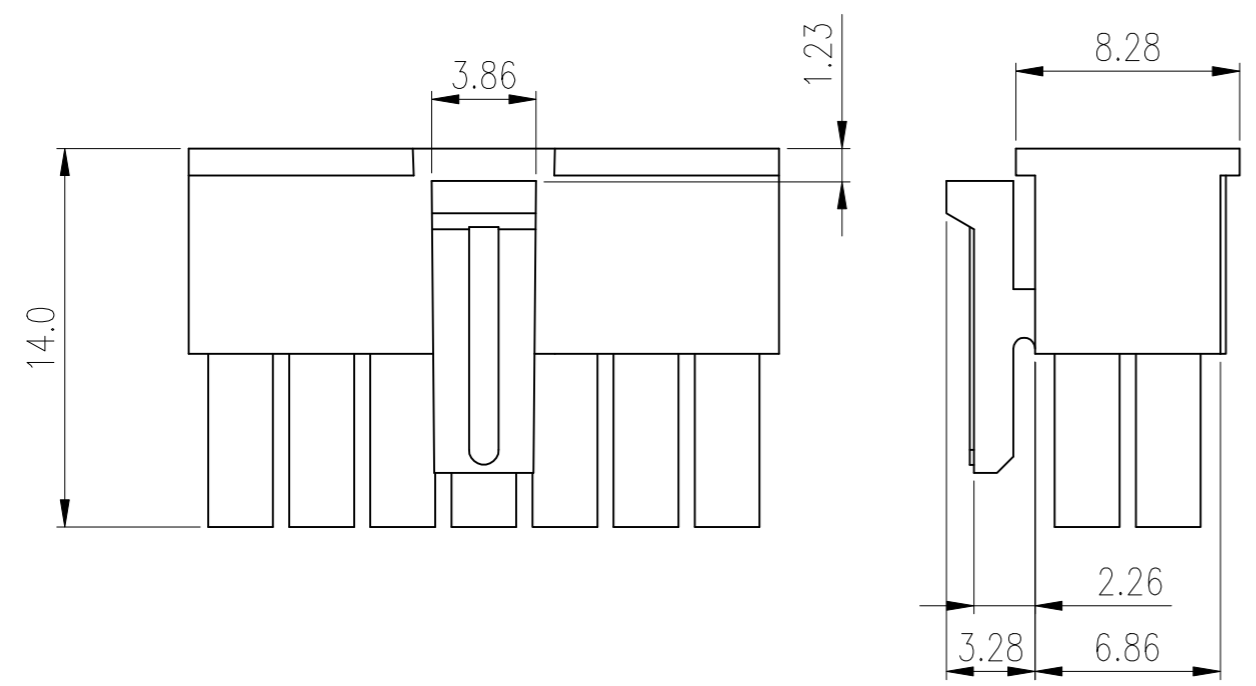
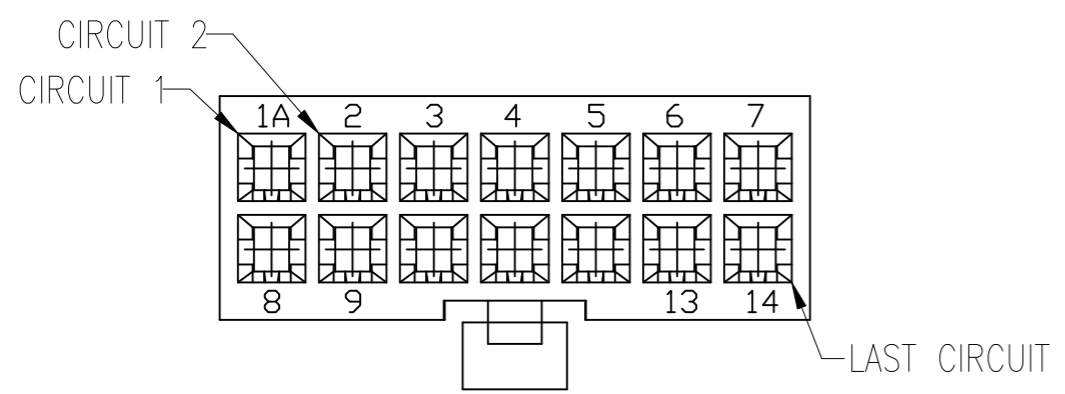

NOTE:
 1. MATERIAL:
 HOUSING: NYLON 66, HALOGEN FREE
 UL94V-0, COLOR: OPTION
 2. REFER GS-20-0399 APPLICATION SPECIFICATION FOR MATING CONNECTOR.
 3. PRODUCT SPECIFICATION: GS-12-1177.
 4. PACKAGE SPECIFICATION: GS-14-2359 (BULK PACKED)
 5. APPLICATION SPECIFICATION: GS-20-0399.
 6. LEAD FREE PRODUCTS MEET EUROPEAN UNION DIRECTIVES AND OTHER COUNTRY REGULATIONS AS DESCRIBED IN GS-47-0004
 7. PART NUMBER SCHEME:
 10127716- XX X LF
 POS. CODE: | | LEAD FREE
 02: 2 POS. | | MATERIAL
 04: 4 POS. | | BLANK: NON GLOW WIRE
 24: 24 POS. | | COMPATIBLE, BLACK.
 | | G: GLOW WIRE COMPATIBLE, BLACK.
 | | 1: NON GLOW WIRE COMPATIBLE, NATURAL
 | | 2: GLOW WIRE COMPATIBLE, NATURAL

DIMENSIONAL & PART NO. TABLE:

PART NO.	POS	A	B
10127716-02XLF	2	3.85	
10127716-04XLF	4	3.0	6.85
10127716-06XLF	6	6.0	9.85
10127716-08XLF	8	9.0	12.85
10127716-10XLF	10	12.0	15.85
10127716-12XLF	12	15.0	18.85
10127716-14XLF	14	18.0	21.85
10127716-16XLF	16	21.0	24.85
10127716-18XLF	18	24.0	27.85
10127716-20XLF	20	27.0	30.85
10127716-22XLF	22	30.0	33.85
10127716-24XLF	24	33.0	36.85

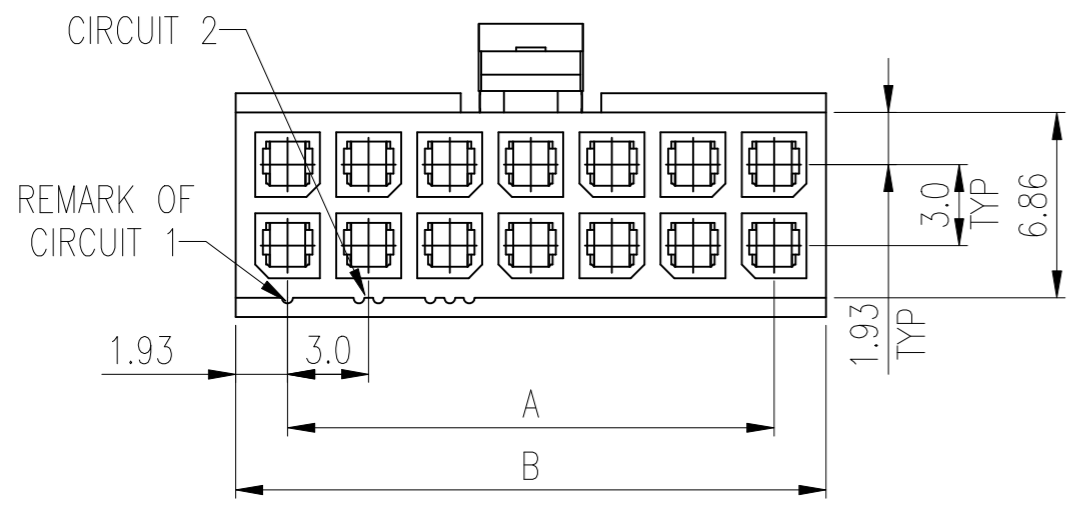

mat'l. code		surface		tolerance		projection		product family	
		ISO 1302		ISO 406 ISO 1101		mm		MINITEK PWR3.0	
ltr		ecn no		dr		date		title	
A		--		Tai		2013-10-21		MINITEK PWR3.0 WIRE CONNECTOR, RECEPTACLE HSG, DUAL ROW	
B		ELX-T-21897		Tai		2015-08-24		dwg no	
C		ELX-2-26735		MZ		2017-04-20		sheet 1 of 2	
D		ELX-N-28649		TONY		2017-11-30		size	
E		ELX-I-43460		ASLAM		2022-01-17		10127716	
								A3	
								type	
								Product Customer Drawing	
sheet index		revision sheet		E E					
				1 2					

Amphenol FCI

© 2016 AFCI

© 2016 AFCl
 Amphenol FCI

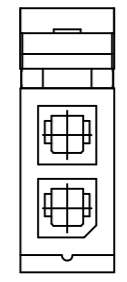

2 POS

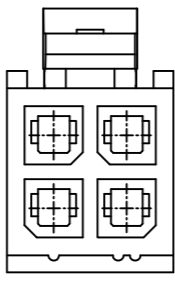

4 POS

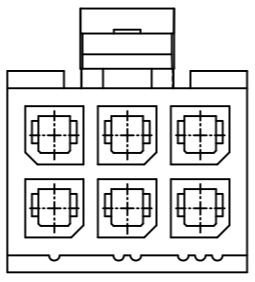

6 POS

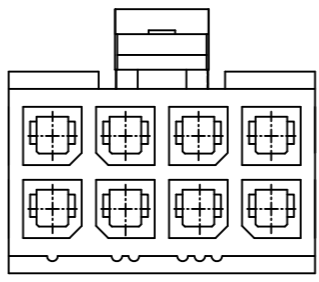

8 POS

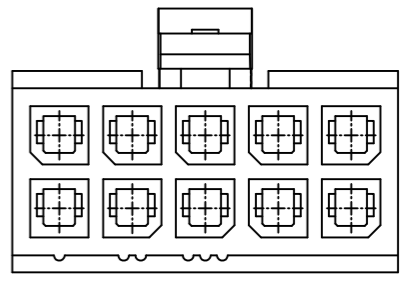

10 POS

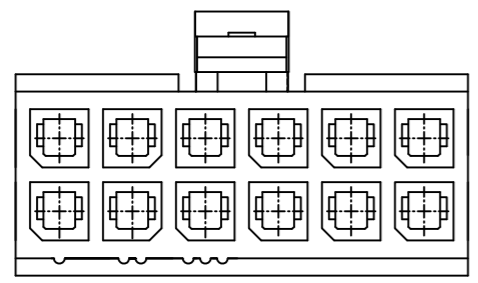

12 POS

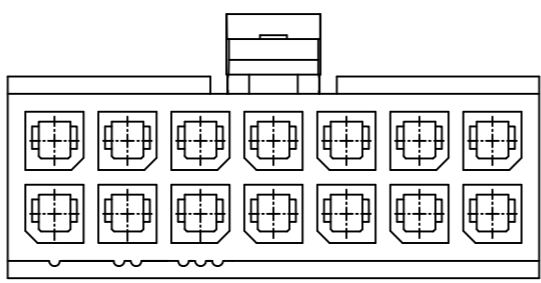

14 POS

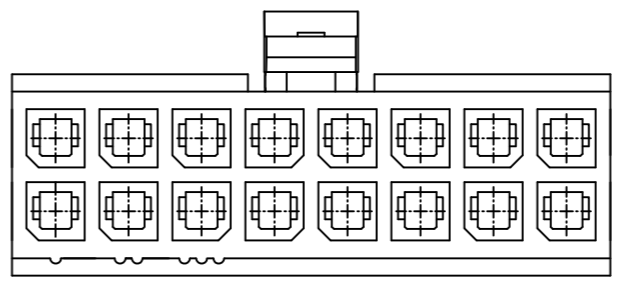

16 POS

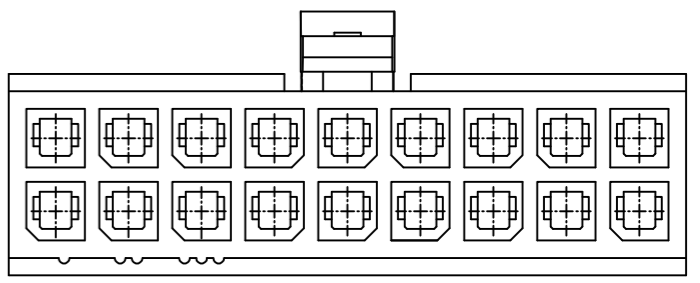

18 POS

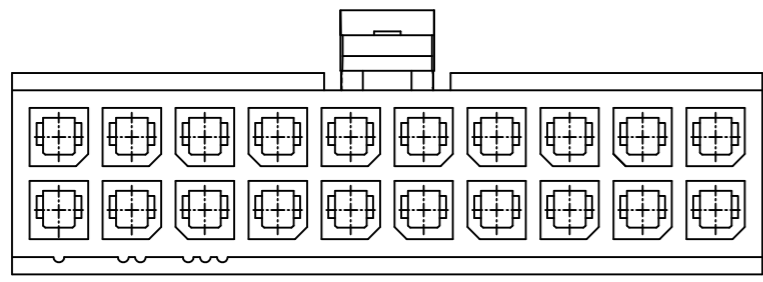

20 POS

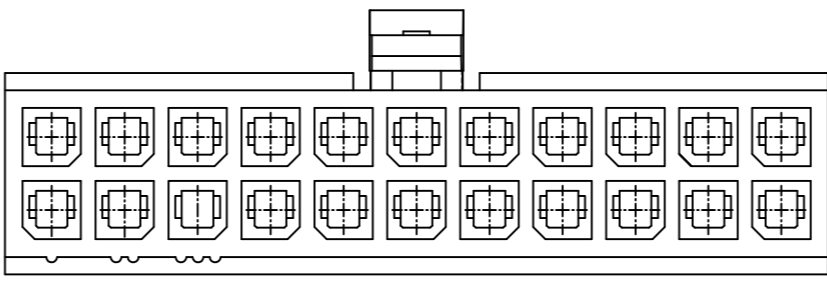

22 POS

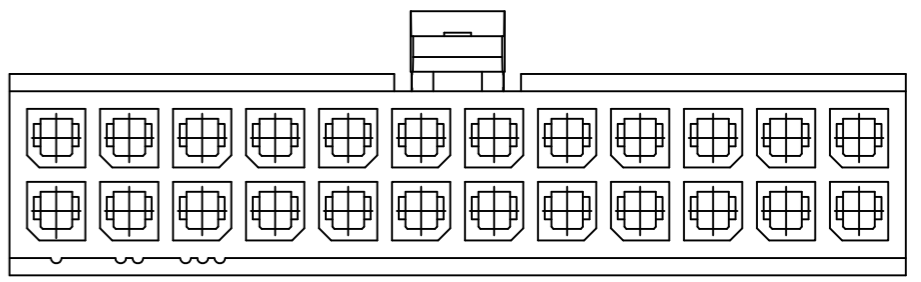

24 POS

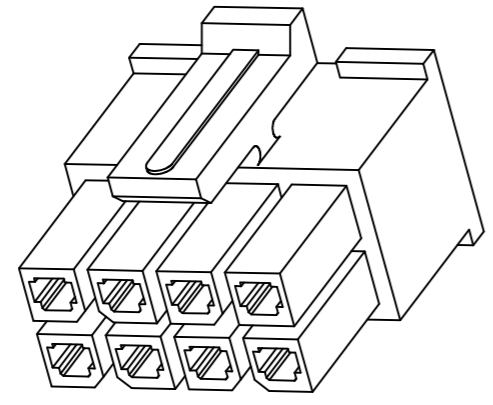

mat'l. code		surface		tolerance		projection		product family			
		ISO 1302		ISO 406 ISO 1101		mm		MINITEK PWR3.0			
ltr		ecn no		dr		date		tolerances unless otherwise specified		title	
								.X±.30		MINITEK PWR3.0 WIRE CONNECTOR,	
								.XX±.20		RECEPTACLE HSG, DUAL ROW	
								scale N.T.S		dwg no	
				dr		KENNY TAI 2013-10-21		Amphenol FCI		sheet 2 of 2 size	
				enfr		AKHIL RAJAN 2022-01-17				10127716 A3	
				chr		MITHUN PAUL 2022-01-17				type	
				appd		SPK 2022-01-17				Product Customer Drawing	
sheet index		revision sheet		E 1		E 2					