



A Product Line of
Diodes Incorporated



SPECIFICATION FOR APPROVAL

CUSTOMER _____

NOMINAL FREQUENCY 50.000000 MHz

HOLDER TYPE TYPE FK 3.2X2.5 SEAM SEALED CRYSTAL CLOCK OSCILLATOR

SPEC. NO. (P/N) FK5000033

CUSTOMER P/N _____

ISSUE DATE March 2, 2018

VERSION B

APPROVED	PREPARED	QA

Diodes Incorporated

No.2, Ziqiang 5th Rd., Zhongli Industrial Park,
Zhongli Dist., Taoyuan City 32063, Taiwan (R.O.C.)
TEL: 886-3-451-8888
FAX: 886-3-461-3865
<https://www.diodes.com>

- *Pb-free
- *RoHS Compliant
- *HF-Halogen Free
- *REACH Compliant

TYPE FK 3.2X2.5 SEAM SEALED CRYSTAL CLOCK OSCILLATOR

FK5000033

VER. B 2-Mar-18

ELECTRICAL SPECIFICATIONS

SRe Part Number : FK5000033

Item	Symbol	Specifications	Units	Notes
Nominal Frequency	Fo	50.000000	MHz	
Frequency Stability	FT	± 50	ppm	**See note
Operating Temperature Range	TR	-20 to +70	°C	
Supply Voltage	V _{DD}	+1.8 ± 5.0%	V	
Logic Type	LT	LVCMOS		
Supply Current, Output Enabled	I _{DD} /OE	7	mA	Max.
Supply Current, Output Disabled	I _{DD} /OD	100	µA	Max.
Duty Cycle (Symmetry)	DC/SY	45 / 55	%	Measured 50% of Waveform
Rise / Fall Time	T _R /T _F	2.5	ns	Max. measured 20/80% of Waveform
Output Voltage "0" Level	V _{OL}	10% V _{DD}	V	Max.
Output Voltage "1" Level	V _{OH}	90% V _{DD}	V	Min.
Output Load	CL	15	pF	Max
Jitter, Phase	RMS	1	ps	Max, 12KHz ~ 5MHz Frequency Band
Jitter, Accumulated	RMS(1-σ)	5	ps	Max, 20,000 Consecutive Periods
Jitter, Peak to Peak	Pk-Pk	30	ps	Max, 100,000 Random Periods
Start Up Time		10	ms	Max.
Storage Temperature Range		-55 to +125	°C	

※ This product doesn't include harmful substance that stipulated by SONY SS-00259 Level 1 and S-AT2-001 Level 1 standard. RoHS Compliant (Pb - Free).

**Stability includes all combinations of Operating Temperature, Load changes, rated Input (Supply) Voltage changes, Initial Calibration Tolerance (25°C), Aging (1 year at 25°C Average Effective Ambient Temperature), Shock and Vibration.

Output Enable / Disable Function

Parameter	Min.	Typ.	Max.	Units	Notes
Input Voltage (Pin1), Output Enable	0.7V _{DD}			V	Or Open
Input Voltage (Pin1), Output Disable (low power standby)			0.3V _{DD}	V	Output is Hi-Z
Internal Pullup Resistance	30			KΩ	
Output Disable Delay			50	ns	

TYPE FK 3.2X2.5 SEAM SEALED CRYSTAL CLOCK OSCILLATOR

FK5000033

VER. B 2-Mar-18

TEST CIRCUIT

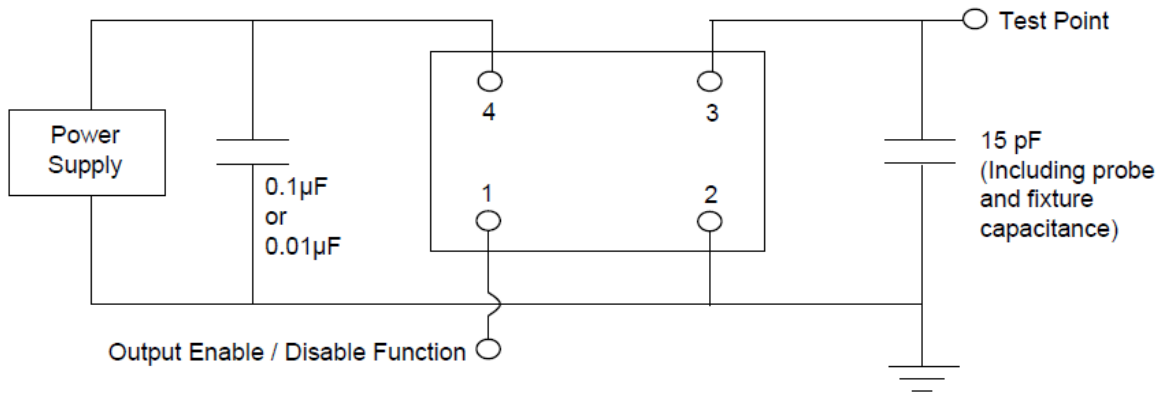

OUTPUT WAVEFORM

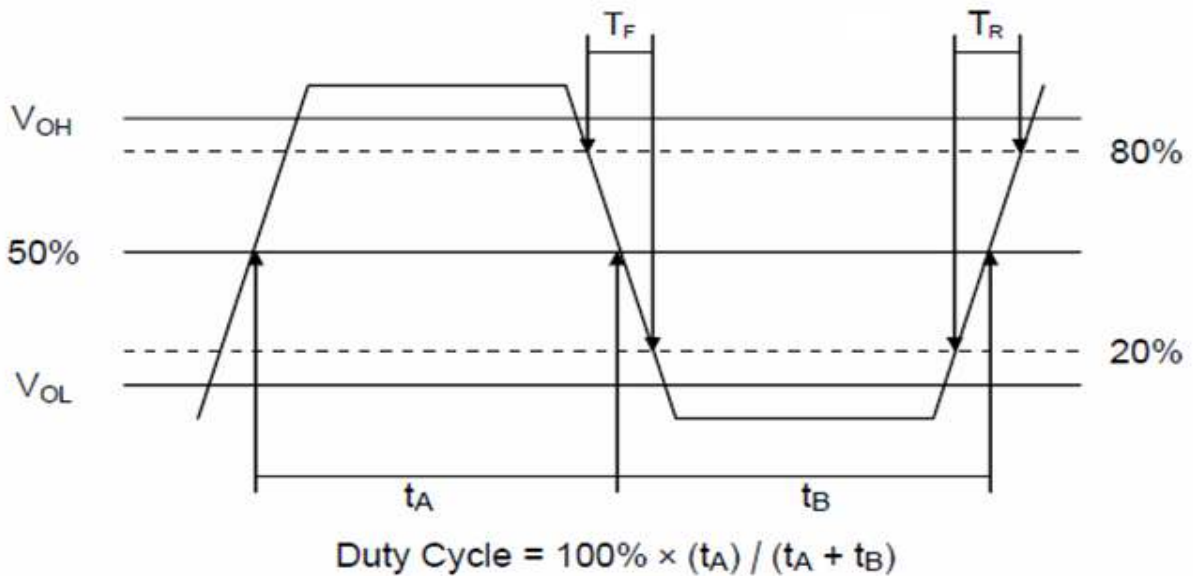

TYPE FK 3.2X2.5 SEAM SEALED CRYSTAL CLOCK OSCILLATOR

FK5000033

VER. B 2-Mar-18

RELIABILITY SPECIFICATIONS

ENVIRONMENTAL:

- a) THERMAL SHOCK: MIL-STD-883, Method 1011, Condition A
- b) MOISTURE RESISTANCE: MIL-STD-883, Method 1004
- c) VIBRATION: MIL-STD-883, Method 2007, Condition A
- d) RESISTANCE TO SOLDERING HEAT: J-STD-020D Table 5-2 Pb-free devices (except 2 cycles max)
- e) HAZARDOUS SUBSTANCE: Pb - free and RoHS Compliant.

MECHANICAL:

- a) SHOCK: MIL-STD-883, Method 2002, Condition B
- b) SOLDERABILITY: JESD22-B102-D Method 2 (Preconditioning E)
- c) TERMINAL STRENGTH: MIL-STD-883, Method 2004, Test Condition D
- d) GROSS LEAK: MIL-STD-883, Method 1014, Condition C
- e) FINE LEAK: MIL-STD-883, Method 1014, Condition A2, $R1=2 \times 10^{-8}$ atm cc/s
- f) SOLVENT RESISTANCE: MIL-STD-202, Method 215

SUGGESTED IR REFLOW PROFILE

*As per IPC-JEDEC J-STD-020D

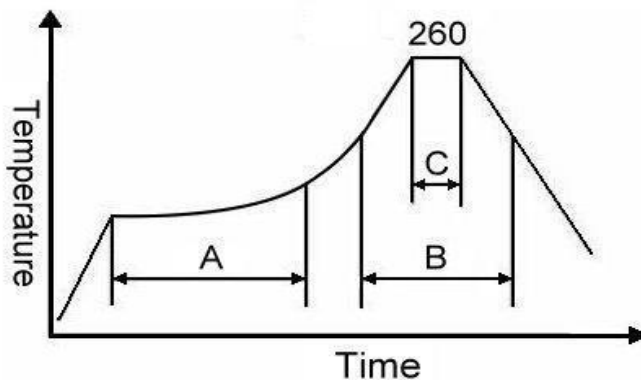

Note:

	Stage	Temperature	Time
A	Preheat	150~200°C	60~120 Sec
B	Primary Heat	217°C	60~150 Sec
C	Peak	260°C	10 Sec

TYPE FK 3.2X2.5 SEAM SEALED CRYSTAL CLOCK OSCILLATOR

FK5000033

VER. B 2-Mar-18

MARKING

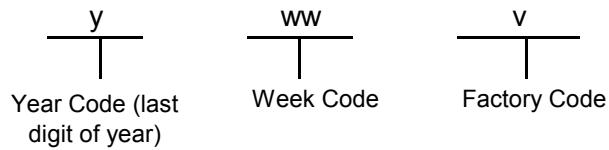
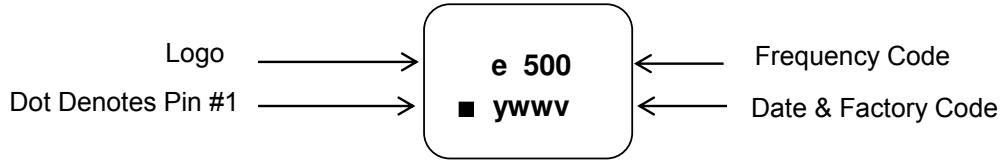

MECHANICAL DRAWINGS (Scale:None. Dimensions are in mm.)

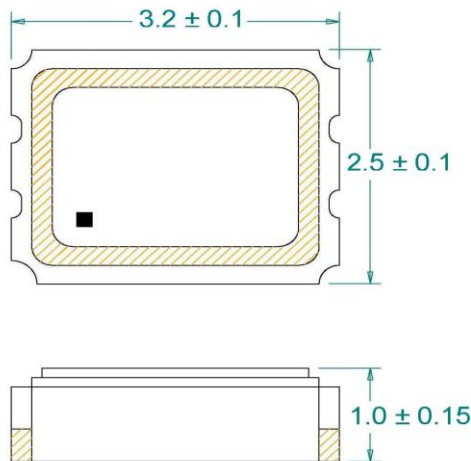

Recommended Land Pattern*

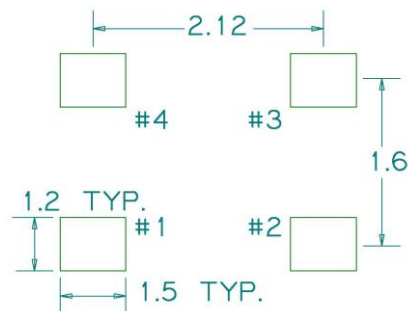

*External high-frequency power decoupling is recommended. (see test circuit for minimum recommendation). To ensure optimal performance, do not route traces beneath the package.

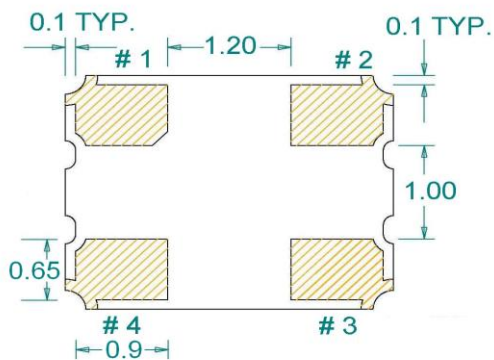

(Bottom View)

Pin	Function
1	OE
2	Ground
3	Clock Output
4	V_{DD}

TYPE FK 3.2X2.5 SEAM SEALED CRYSTAL CLOCK OSCILLATOR

FK5000033

VER. B 2-Mar-18

TAPE&REEL

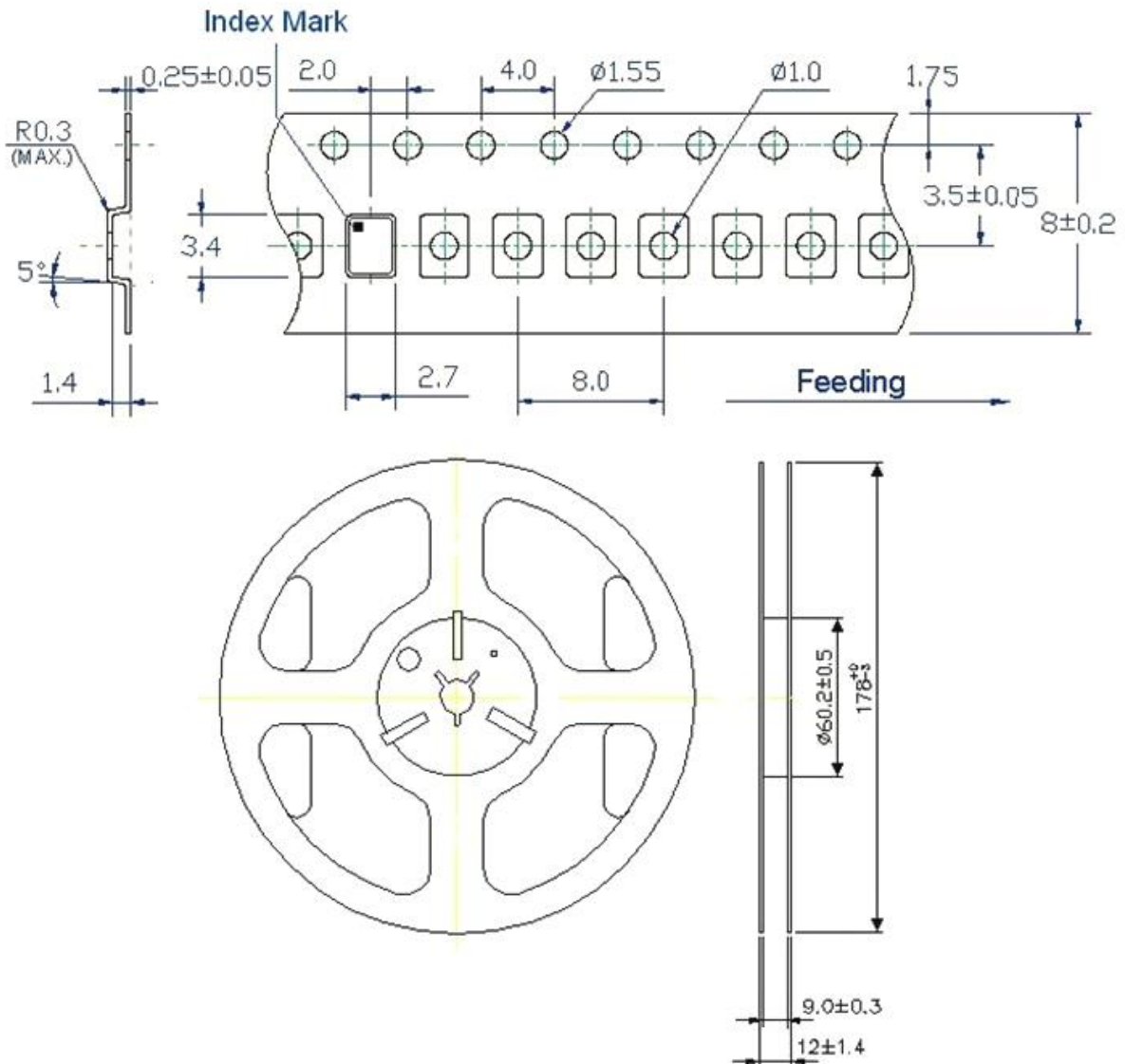

1. 230mm minimum leader which consist of carrier and/or tape followed by a minimum of 160mm of empty carrier tape sealed with cover tape.
2. 160mm minimum trailer of empty carrier tape sealed with cover tape.

TYPE FK 3.2X2.5 SEAM SEALED CRYSTAL CLOCK OSCILLATOR

FK5000033

VER. B 2-Mar-18

PACKING

