

Typical unit

## FEATURES

- Support IEEE802.3af class0
- 12W DC-DC converter (12Vout)
- 37-57V Input Voltage range
- 14.8 x 26 x 6.2mm Size
- 84% efficiency (typical, 12Vout).
- Surface mount module
- 2250Vdc Input-Output Isolation
- Operating Temperature range -40 to +85 °C

## PRODUCT OVERVIEW

The MYBSP01201ABF/MYBSP00502ABF is an isolated, regulated, DC-DC converter for PoE PD that has an input range of 37-57Vdc with a typical efficiency of 84%(12Vout), and full 2250 Volt DC isolation. The MYBSP01201ABF/MYBSP00502ABF is ideal for IEEE 802.3af Compliant Devices. Module has self-protection features. These include input undervoltage lockout and output current limit. And the module has detection and classification for compliant IEEE802.3af.

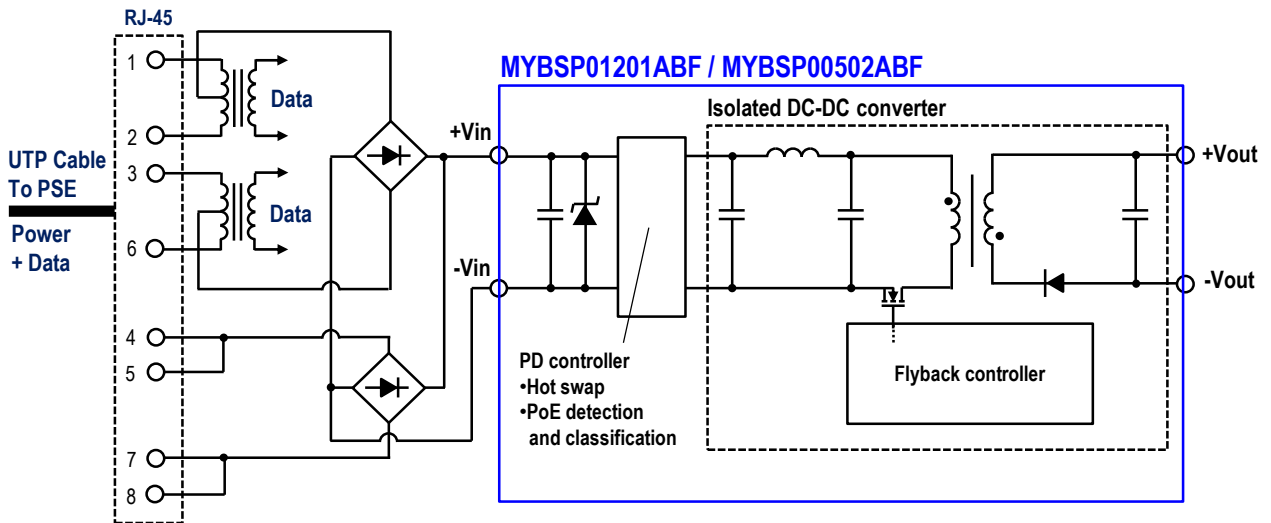

Figure 1. Simplified Block Diagram  
Typical topology is shown.

## PERFORMANCE SPECIFICATIONS SUMMARY AND ORDERING GUIDE

Model Number	Output						Input			Efficiency (%)		Package (mm)
	Vout (Vdc)	Iout (A,Max.)	Power (W)	R/N Typ. (mVp-p)	Regulation Typ.		Vin Nom. (Vdc)	Range (Vdc)	Iin, full load Typ.(A)	Min.	Typ.	
					Line (%)	Load (%)						
MYBSP01201ABF	12	1	12	150	±0.4	±0.4	48	37-57	0.3	81	84	14.8 x 26 x 6.2
MYBSP00502ABF	5	2	10	150	±0.6	±0.5	48	37-57	0.3	76	80	

1. Please refer to the Part Number Structure for additional ordering information and options.
2. All specifications are at nominal line voltage, full load, +25°C unless otherwise stated.

## PART NUMBER STRUCTURE

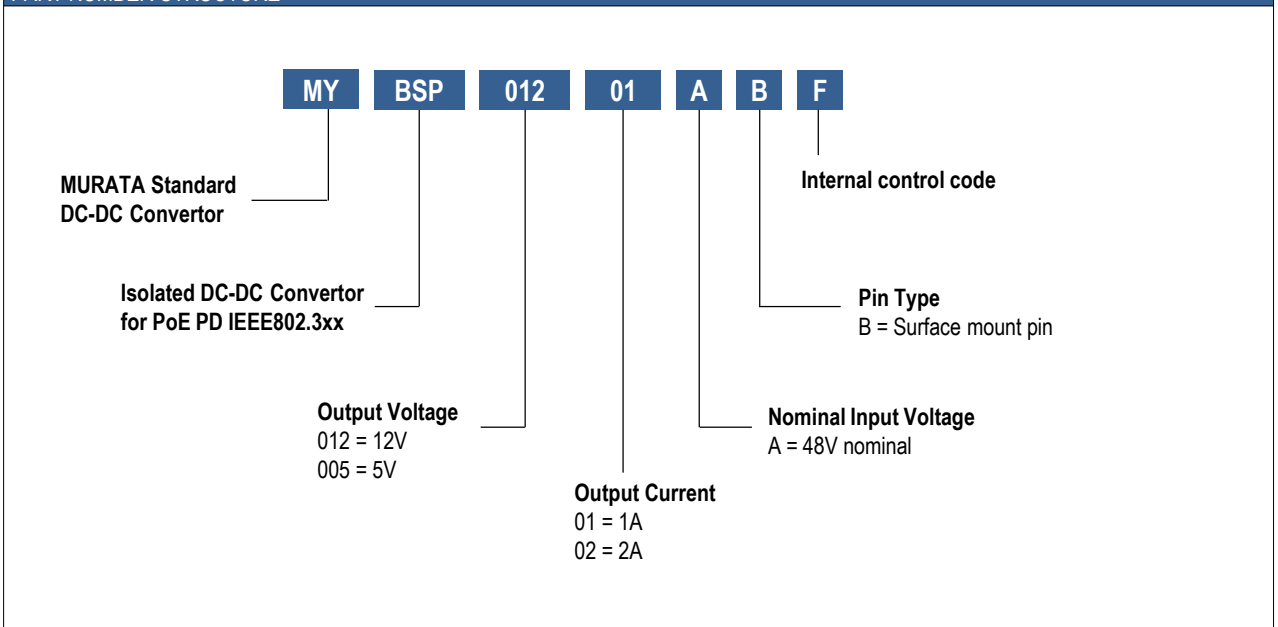

## Product Marking

Layout  
Top View

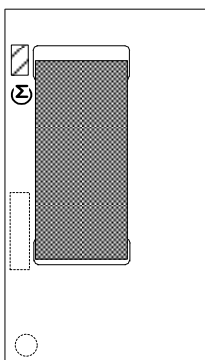

1Pin

Codes

- MFG ID
- Product Code
- Internal Manufacturing Code

Part Number	Product Code
MYBSP01201ABF	EE
MYBSP00502ABF	EM

### FUNCTIONAL SPECIFICATIONS, MYBSP01201ABF

ABSOLUTE MAXIMUM RATINGS	Conditions	Minimum	Typical / Nominal	Maximum	Units
Input Voltage, Continuous		0		57	Vdc
Input Voltage, Transient	100ms max. duration			60	Vdc
Isolation Voltage	Input to output, Leak current 1mA max for 1minute at +25°C/60%RH.			2250	Vdc
Output Power		0		12	W
Output Current	Current-limited, no damage, short-circuit protected	0		1	A
Storage Temperature Range	Vin = Zero (no power)	-40		90	°C
Absolute maximums are stress ratings. Exposure of devices to greater than any of these conditions may adversely affect long-term reliability. Proper operation under conditions other than those listed in the Performance/Functional Specifications Table is not implied or recommended.					
<b>INPUT</b>					
Operating Voltage Range	Slew rate less than 30V/μs	37	48	57	Vdc
Start-up threshold	Rising input voltage	34.9	37.5	40.1	Vdc
Undervoltage shutdown	Falling input voltage	28.9	31	33.1	Vdc
Internal Filter Type			Pi		
<b>Input current</b>					
Full Load Conditions	Vin = nom., Iout = max		0.3		A
Low Line Input current	Vin = min., Iout = max.		0.4		A
On Resistance of Internal Hotswap			0.48		Ω
Resistance for detection	Vin=2.7 to 10.1V		25		kΩ
Classification current	Vin=14.5 to 20.5V		2		mA
<b>GENERAL and SAFETY</b>					
Efficiency	Vin = 48V, full load	81	84		%
<b>Isolation</b>					
Isolation Voltage	Input to output, Leak current 1mA max for 1minute at +25°C/60%RH.	2250			Vdc
Insulation Safety Rating			Functional		
Isolation Capacitance			1500		pF
Calculated MTBF	Telcordia SR-332, issue 1, class 3, ground fixed, Ta = +25°C		4406		Hours x 10 <sup>3</sup>
<b>DYNAMIC CHARACTERISTIC</b>					
Fixed Switching Frequency *1	Vin = 48V, Iout = max		110		kHz
Vout Rise Time	From 10%-90% of Vout		4		ms
Dynamic Load Response	50-100-50% load step to 1% of Vout		500		μSec
Dynamic Load Peak Deviation	same as above		100		mVdc

## FUNCTIONAL SPECIFICATIONS, MYBSP01201ABF(CONT.)

OUTPUT	Conditions	Minimum	Typical / Nominal	Maximum	Units
Total Output Power		0		12	W
<b>Voltage</b>					
Nominal Output Voltage	I <sub>out</sub> = 0.1A to max *2	11.4	12	12.6	V <sub>dc</sub>
Overvoltage Protection			None		V <sub>dc</sub>
<b>Current</b>					
Output Current Range *3		0		1	A
Current Limit Inception		1.05			A
Short circuit protection method			Non-latching		
<b>Regulation</b>					
Line Regulation	V <sub>in</sub> =min to max., V <sub>out</sub> =nom., full load		0.4		% of V <sub>out</sub>
Load Regulation	I <sub>out</sub> = 0.1A to max.		0.4		% of V <sub>out</sub>
Ripple and Noise	150 MHz BW, C <sub>out</sub> =0.1μF MLCC paralleled with 10μF and 100μF		150	300	mV pk-pk
Maximum Capacitive Loading	Low ESR	100		400	μF
<b>MECHANICAL</b>					
Outline Dimensions	L x W x H		14.8 x 26 x 6.2		mm
Weight			4.5		Grams
Pin Diameter			1.6		mm
Pin Material			Copper alloy		
<b>ENVIRONMENTAL</b>					
Operating Ambient Temperature Range		-40		85	°C
Storage Temperature	V <sub>in</sub> = Zero (no power)	-40		90	°C
Electromagnetic Interference Conducted, EN55022/CISPR22	External filter is required		A		Class

### Specification Notes

Unless otherwise noted, all specifications are typical at nominal input voltage, nominal output voltage and full load. General conditions are +25° C ambient temperature, near sea level altitude, natural convection airflow. All models are tested and specified with external parallel 0.1μF and 10μF and 100μF output capacitors (See Technical Notes).

\*1 Variable Frequency Operation.

This module emits audible noise at light load.

\*2 Maximum output voltage is 14.4V if I<sub>out</sub> is less than 0.1A.

\*3 Input current must be greater than or equal to 10mA if your application applies Maintain Power Signature(MPS) by IEEE802.3af. Please check with your application.

PERFORMANCE DATA, MYBSP01201ABF

Efficiency vs. Line Voltage and Load Current  
( $T_a=+25^{\circ}\text{C}$ )

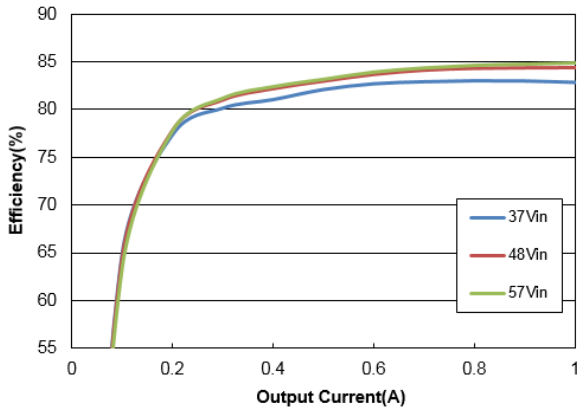

Load Regulation  
( $T_a=+25^{\circ}\text{C}$ )

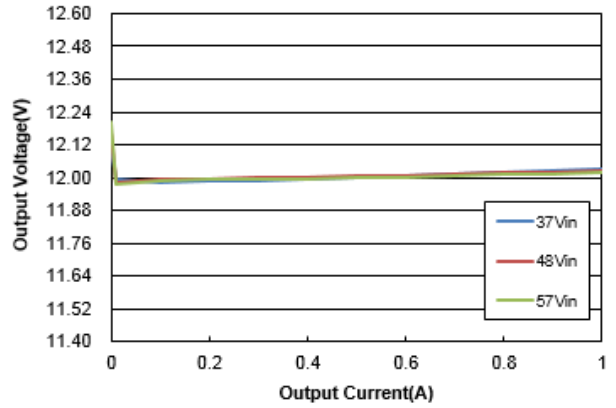

Vout Start-up  
( $V_{in}=48\text{V}$ ,  $I_{out}=1\text{A}$ ,  $T_a=+25^{\circ}\text{C}$ )

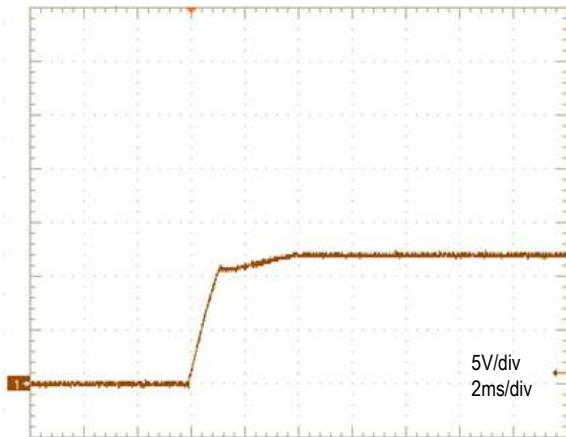

Output Ripple and Noise  
( $V_{in}=48\text{V}$ ,  $I_{out}=1\text{A}$ ,  $T_a=+25^{\circ}\text{C}$ )

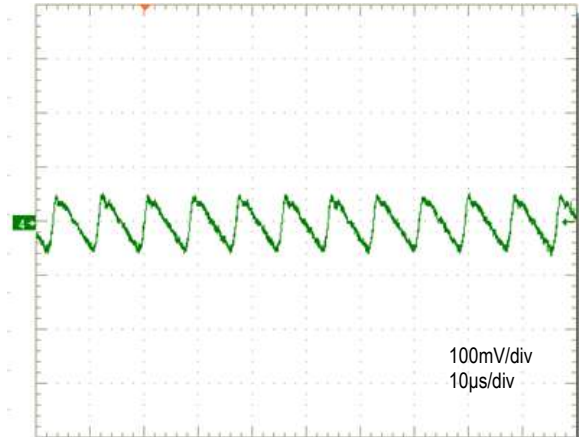

Transient Response ( $V_{in}=48\text{V}$ ,  $I_{out}=0.5\text{A}$  to  $1\text{A}$  to  $0.5\text{A}$ ,  $T_a=+25^{\circ}\text{C}$ )  
Ch1=Vout, 200mV/div, Ch2=Iout, 500mA/div

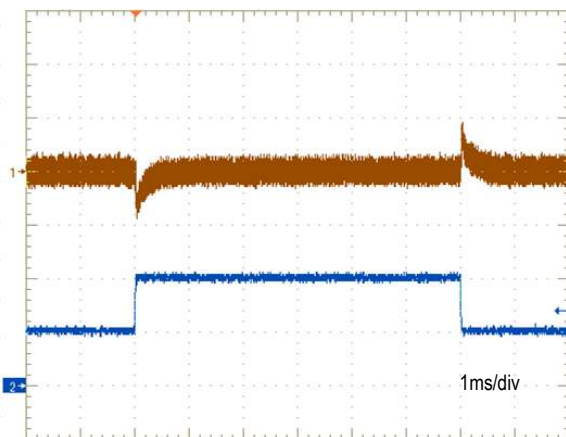

Thermal Derating  
Unit under test (UUT) is covered by acrylic box to avoid airflow.  
( $V_{in}=48\text{V}$ , See Technical Notes)

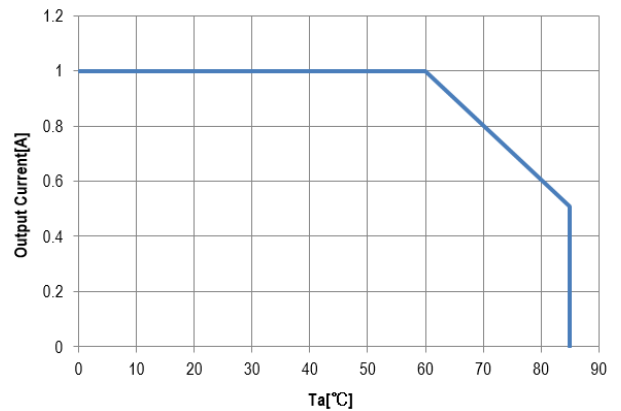

PERFORMANCE DATA, MYBSP01201ABF(CONT.)

Conduction Noise ( $V_{in}=48V$ ,  $I_{out}=1A$ ,  $T_a=+25^{\circ}C$ )  
with External Input Filter

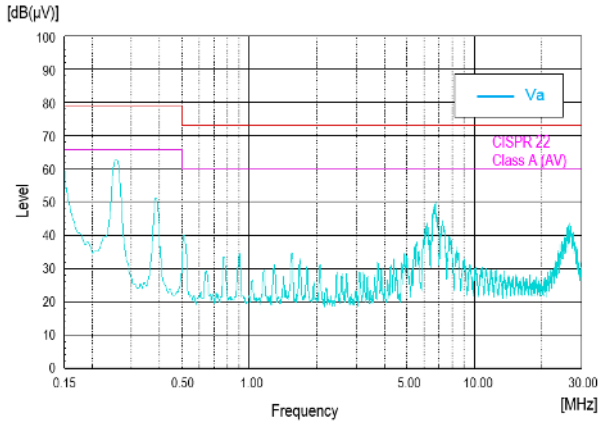

Conduction Noise ( $V_{in}=48V$ ,  $I_{out}=1A$ ,  $T_a=+25^{\circ}C$ )  
with External Input Filter

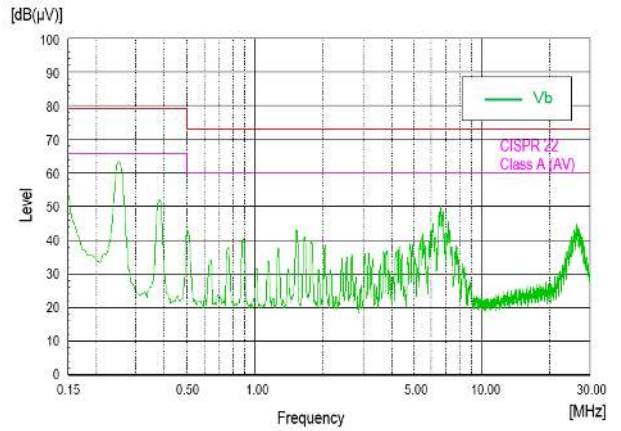

### FUNCTIONAL SPECIFICATIONS, MYBSP00502ABF

ABSOLUTE MAXIMUM RATINGS	Conditions	Minimum	Typical / Nominal	Maximum	Units
Input Voltage, Continuous		0		57	Vdc
Input Voltage, Transient	100ms max. duration			60	Vdc
Isolation Voltage	Input to output, Leak current 1mA max for 1minute at +25°C/60%RH.			2250	Vdc
Output Power		0		10	W
Output Current	Current-limited, no damage, short-circuit protected	0		2	A
Storage Temperature Range	Vin = Zero (no power)	-40		90	°C
Absolute maximums are stress ratings. Exposure of devices to greater than any of these conditions may adversely affect long-term reliability. Proper operation under conditions other than those listed in the Performance/Functional Specifications Table is not implied or recommended.					
<b>INPUT</b>					
Operating Voltage Range	Slew rate less than 30V/μs	37	48	57	Vdc
Start-up threshold	Rising input voltage	34.9	37.5	40.1	Vdc
Undervoltage shutdown	Falling input voltage	28.9	31	33.1	Vdc
Internal Filter Type			Pi		
<b>Input current</b>					
Full Load Conditions	Vin = nom., Iout = max		0.3		A
Low Line Input current	Vin = min., Iout = max.		0.4		A
On Resistance of Internal Hotswap			0.48		Ω
Resistance for detection	Vin=2.7 to 10.1V		25		kΩ
Classification current	Vin=14.5 to 20.5V		2		mA
<b>GENERAL and SAFETY</b>					
Efficiency	Vin = 48V, full load	76	80		%
<b>Isolation</b>					
Isolation Voltage	Input to output, Leak current 1mA max for 1minute at +25°C/60%RH.	2250			Vdc
Insulation Safety Rating			Functional		
Isolation Capacitance			1500		pF
Calculated MTBF	Telcordia SR-332, issue 1, class 3, ground fixed, Ta = +25°C		5605		Hours x 10 <sup>3</sup>
<b>DYNAMIC CHARACTERISTIC</b>					
Fixed Switching Frequency *1	Vin = 48V, Iout = max		100		kHz
Vout Rise Time	From 10%-90% of Vout		1		ms
Dynamic Load Response	50-100-50% load step to 1% of Vout		500		μSec
Dynamic Load Peak Deviation	same as above		100		mVdc

## FUNCTIONAL SPECIFICATIONS, MYBSP00502ABF(CONT.)

OUTPUT	Conditions	Minimum	Typical / Nominal	Maximum	Units
Total Output Power		0		10	W
<b>Voltage</b>					
Nominal Output Voltage	I <sub>out</sub> =0.2A to max *2	4.7	5	5.3	Vdc
Oversvoltage Protection			None		Vdc
<b>Current</b>					
Output Current Range *3		0		2	A
Current Limit Inception		2.1			A
Short circuit protection method			Non-latching		
<b>Regulation</b>					
Line Regulation	V <sub>in</sub> =min. to max., V <sub>out</sub> =nom., full load		0.6		% of V <sub>out</sub>
Load Regulation	I <sub>out</sub> = 0.2A to max.		0.5		% of V <sub>out</sub>
Ripple and Noise	150 MHz BW, C <sub>out</sub> =0.1μF MLCC paralleled with 10μF and 300μF		150	300	mV pk-pk
Maximum Capacitive Loading	Low ESR	300		600	μF
<b>MECHANICAL</b>					
Outline Dimensions	L x W x H		14.8 x 26 x 6.2		mm
Weight			4.7		Grams
Pin Diameter			1.6		mm
Pin Material			Copper alloy		
<b>ENVIRONMENTAL</b>					
Operating Ambient Temperature Range		-40		85	°C
Storage Temperature	V <sub>in</sub> = Zero (no power)	-40		90	°C
Electromagnetic Interference Conducted, EN55022/CISPR22	External filter is required		A		Class

### Specification Notes

Unless otherwise noted, all specifications are typical at nominal input voltage, nominal output voltage and full load. General conditions are +25° C ambient temperature, near sea level altitude, natural convection airflow. All models are tested and specified with external parallel 0.1μF and 10μF and 300μF output capacitors (See Technical Notes).

\*1 Variable Frequency Operation.

This module emits audible noise at light load.

\*2 Maximum output voltage is 6V if I<sub>out</sub> is less than 0.2A.

\*3 Input current must be greater than or equal to 10mA if your application applies Maintain Power Signature(MPS) by IEEE802.3af. Please check with your application.



PERFORMANCE DATA, MYBSP00502ABF

Efficiency vs. Line Voltage and Load Current  
( $T_a=+25^\circ\text{C}$ )

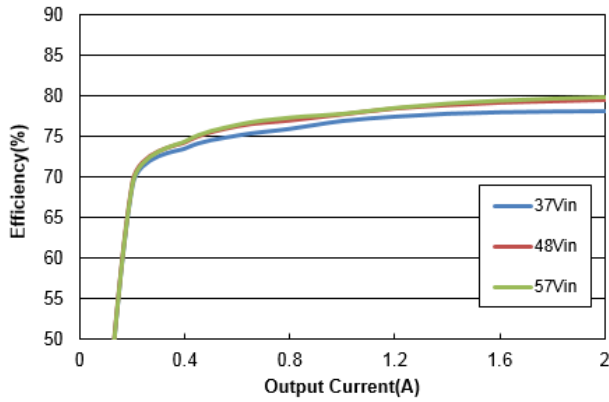

Load Regulation  
( $T_a=+25^\circ\text{C}$ )

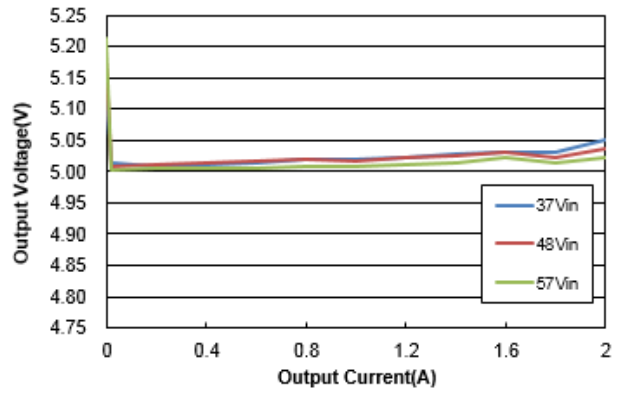

Vout Start-up  
( $V_{in}=48\text{V}$ ,  $I_{out}=2\text{A}$ ,  $T_a=+25^\circ\text{C}$ )

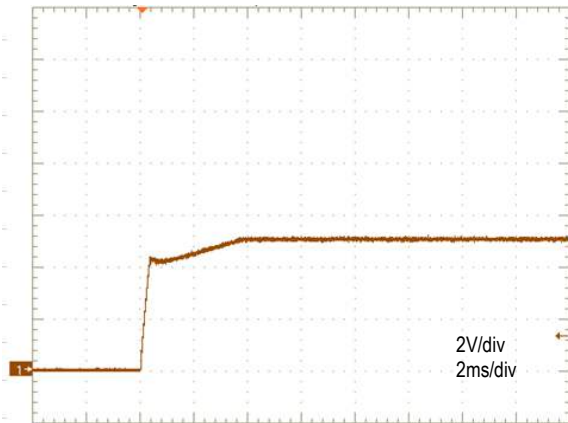

Output Ripple and Noise  
( $V_{in}=48\text{V}$ ,  $I_{out}=2\text{A}$ ,  $T_a=+25^\circ\text{C}$ )

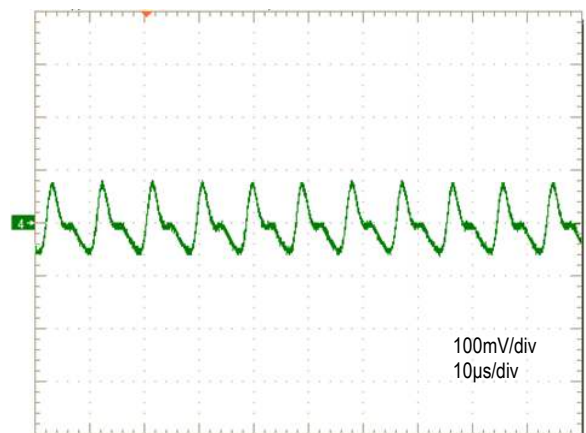

Transient Response ( $V_{in}=48\text{V}$ ,  $I_{out}=1\text{A}$  to  $2\text{A}$ ,  $T_a=+25^\circ\text{C}$ )  
Ch2=Vout, 200mV/div, Ch4=Iout, 1A/div

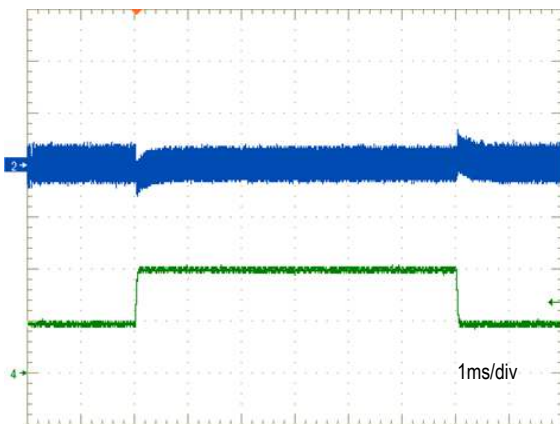

Thermal Derating  
Unit under test (UUT) is covered by acrylic box to avoid airflow.  
( $V_{in}=48\text{V}$ , See Technical Notes)

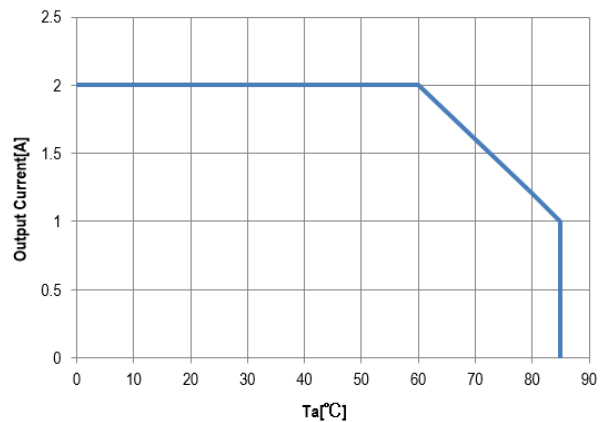

PERFORMANCE DATA, MYBSP00502ABF(CONT.)

Conduction Noise ( $V_{in}=48V$ ,  $I_{out}=2A$ ,  $T_a=+25^{\circ}C$ )  
with External Input Filter

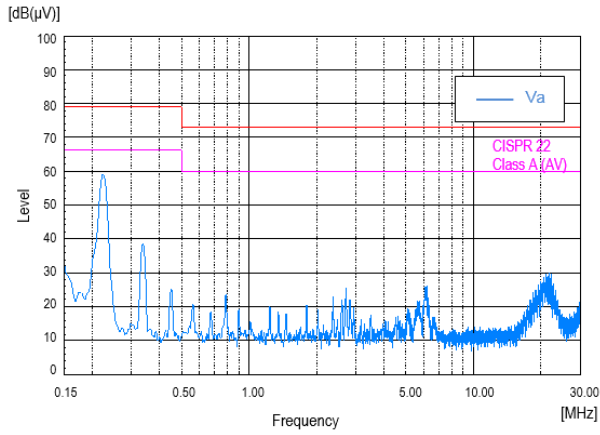

Conduction Noise ( $V_{in}=48V$ ,  $I_{out}=2A$ ,  $T_a=+25^{\circ}C$ )  
with External Input Filter

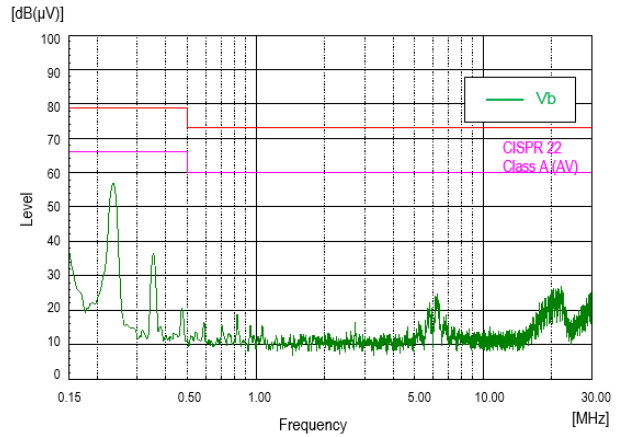

**MECHANICAL SPECIFICATIONS**

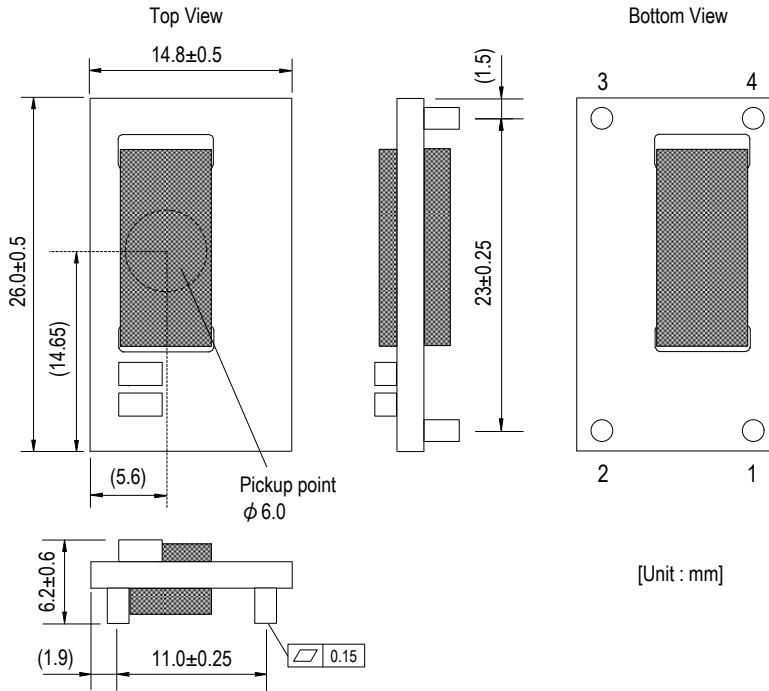

INPUT / OUTPUT CONNECTIONS			
Pin	Designation	Function	Pin size
1	+Vin	Positive Input Voltage	Φ1.6
2	-Vin	Negative Input Voltage	Φ1.6
3	-Vout	Negative Output Voltage	Φ1.6
4	+Vout	Positive Output Voltage	Φ1.6

**RECOMMENDED FOOTPRINT (Top View)**

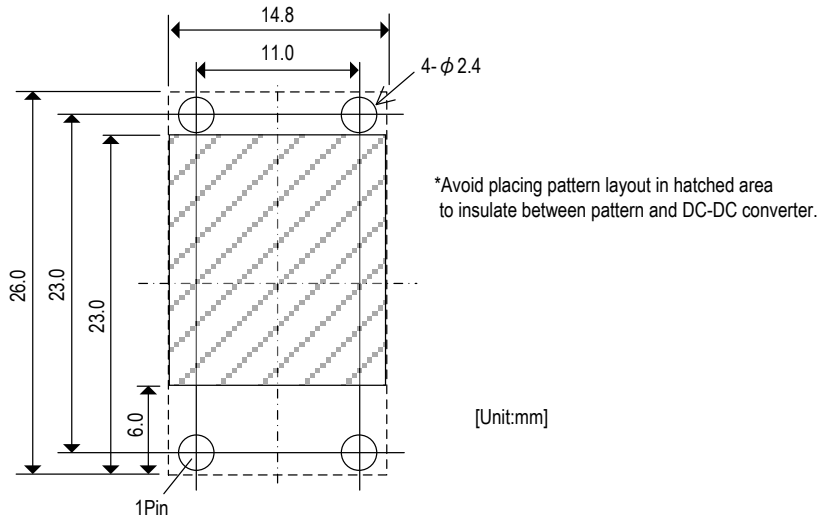

PACKAGING INFORMATION (SURFACE MOUNT)

Packaging form  
Tray Specification

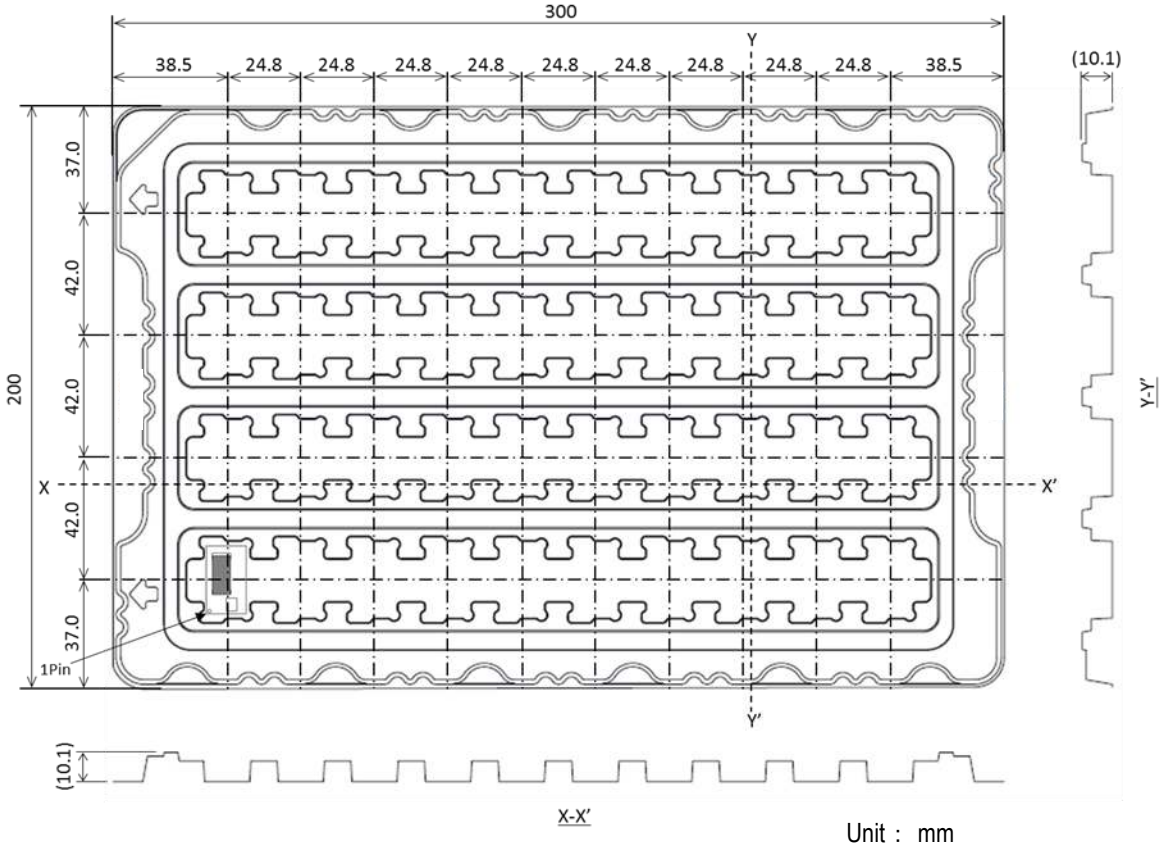

Pieces of contained products per corrugated box.  
Maximum contained products pieces 200 pcs/corrugated box.

Further plural sheets of corrugated cardboard are placed on the top of the tray cover according to number of contained trays in order to full up the space in a corrugated box.

PACKAGING INFORMATION (SURFACE MOUNT)

Packaging form  
Tray Specification

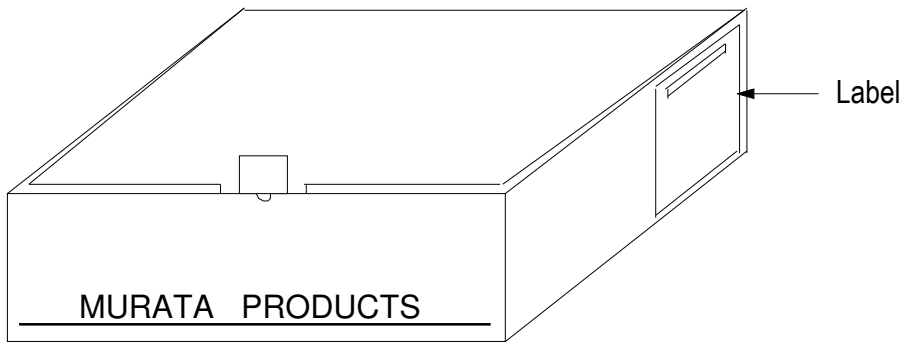
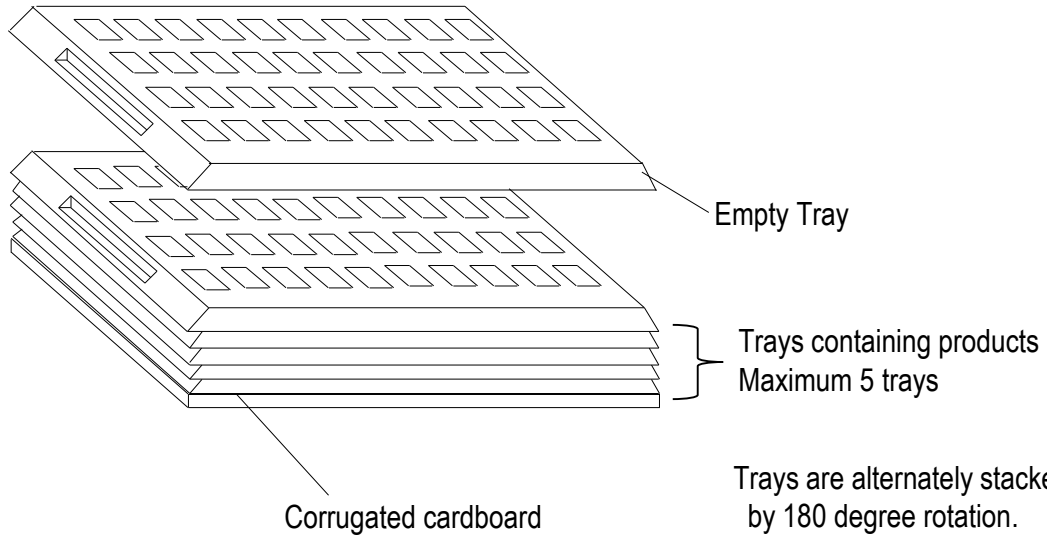

### TECHNICAL NOTES

#### Over Current Protection

Over Current Protection operates with a controller circuit failure or over-load condition. After rejected the abnormal mode, DC-DC converter will automatically restart.

However output short voltage affect long-term reliability.

#### External Input Capacitor

Do not connect any capacitor between positive input and negative input to avoid large inrush current. It is one of the requirements of IEEE802.3af standard.

#### Test Circuit

The initial values in Functional Specification are measured in the following test circuit.

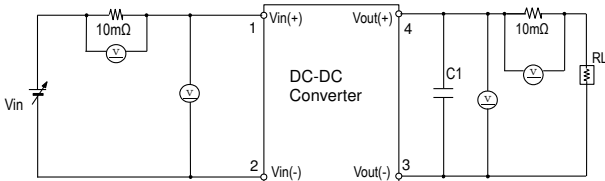

C1 : Ceramic Capacitor 100μF(MYBSP01201ABF)  
300μF(MYBSP00502ABF)

RL : Electronic Load Device : LN-1000A-G7 KEISOKU GIKEN equivalent

Vin : DC Power Supply :Model HP6675A KEYSIGHT equivalent

Ⓜ : Digital Multimeter :Model HP34401A KEYSIGHT equivalent

When deviating from the above, DC-DC converter may operate abnormally. It should be fully confirmed on your board before use.

#### Ripple Noise Test

Output ripple noise is measured using designated external output components, circuits and layout as shown below.

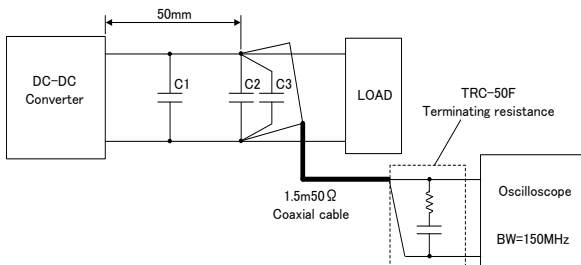

C1 : Ceramic Capacitor 100μF(MYBSP01201ABF)  
300μF(MYBSP00502ABF)

C2 : Ceramic Capacitor 0.1μF

C3 : Ceramic Capacitor 10μF

#### Conduction Noise

The external input filter is installed and the circuit diagram is shown below.

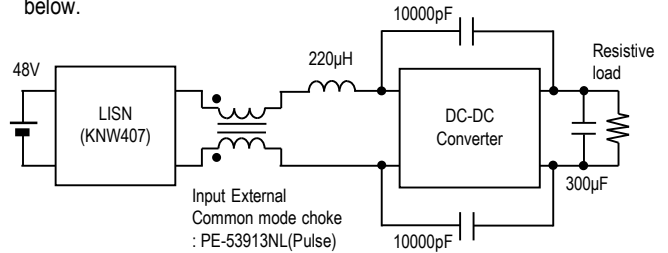

#### Thermal Derating Condition

The output current is limited by the derating curve. The derating curve in this datasheet illustrate typical operation under a variety of conditions.

DC-DC Converter is tested on a 101.6x188mm, 2 layers Copper evaluation board at Vin=48V.

The Unit Under Test (UUT) is set up as shown below.

UUT is covered by acrylic box to avoid airflow.

The temperature measurement points are shown below table. The temperature of measurement points should not exceed the maximum temperatures in the below table.

Position	Description	Max temperature
P1	IC	$T_{P1MAX} = 110^{\circ}C$
P2	Diode	$T_{P2MAX} = 124^{\circ}C$
P3	Transformer pattern	$T_{P3MAX} = 125^{\circ}C$

Top View

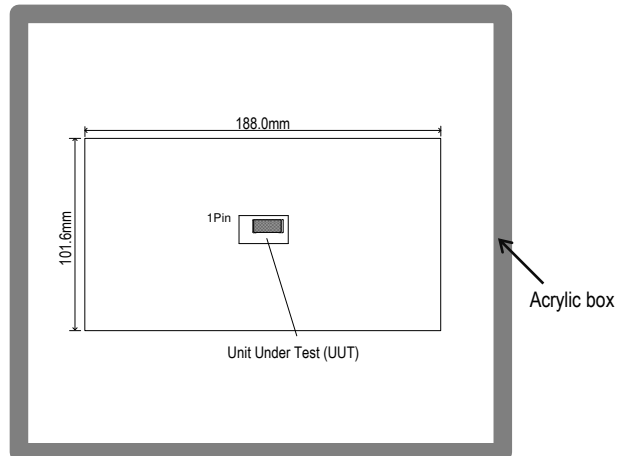
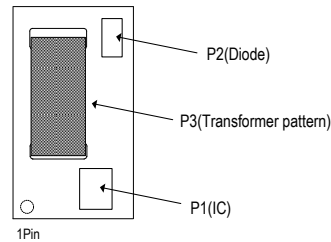

**Detection and Hardware Classification**

DC-DC converter implements IEEE 802.3af compliant detection and hardware classification.

When DC-DC converter(PD) is connected to PSE, the PSE applies two voltages in the range of 2.8 V to 10 V and measures the corresponding current. Connection to PD is detected by measured current.(Detection)

After Detection, the PSE applies voltage in the range of 15.5 V to 20.5 V and measures the corresponding current. PD is classified by measured current.(Hardware Classification)

Please check with your application.

**SMT Reflow Soldering Guidelines**

The surface-mount reflow solder profile is shown below.

This graph should be used only as a guideline.

Reflow Soldering Profiles : JEDEC IPC/JEDEC J-STD-020D

Soldering temperature	245°C +0/-5°C
Soldering time	30 seconds, 240°C-245°C
Heating time	60~150 seconds, 217°C min.
Preheat time	60~120 seconds, 150°C-200°C
Programming rate	3°C /sec.max., 217°C-245°C
Descending rate	6°C /sec.max.
Total soldering time	8 minutes max.,25°C-245°C
Time	1time

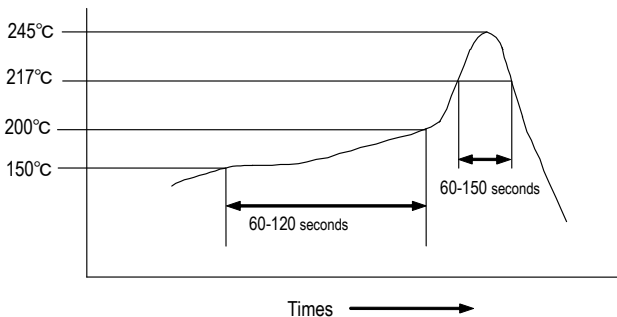

Do not vibrate for the products on reflow. Please need to take care temperature control because mounted parts may come off if the product is left under the high temperature. Do not mount on backside of the board.

Many other factors influence the success of SMT reflow soldering. Since your production environment may differ, please thoroughly review these guidelines with your process engineers.

**Functional Specifications**

Please contact Murata Sales before using this product for the applications listed below. These are applications that require very high reliability of prevention of defects which might directly cause damage to third party's life, body, or property.

1. Aircraft equipment
2. Aerospace equipment
3. Undersea equipment
4. Power plant control equipment
5. Medical equipment
6. Transportation equipment (cars, buses, trucks, trains, ships, etc.)
7. Traffic signal equipment
8. Disaster prevention /crime prevention equipment
9. Data-processing equipment
10. Application of similar complexity and /or reliability listed as above.

**Storage**

Please store this product in an environment where the temperature/humidity is stable in the range 0 to 40° C/10 to 75%RH and no direct sunlight. Use the product within 6 months after delivery.

Please avoid storage conditions where humidity and temperature change rapidly, as that may cause condensation on the product, which might degrade the quality of the product.

Please do not store the product environments that are dusty, in direct exposure to sea breeze, or in an atmosphere containing corrosive gas (Cl2, NH3, SO2, NOX and so on).

**Operational environment and operational conditions**

This product is not chemical-proof or rust-proof.

In order to prevent this product from leakage of electricity and/or abnormal temperature increase, do not use the product under the following circumstances:

- (1) in an atmosphere containing corrosive gas (Cl2, NH3, SO2, NOX and so on).
- (2) in a dusty place.
- (3) in a place exposed to direct sunlight.
- (4) in such a place where water splashes or in such a humid place where water condenses.
- (5) in a place exposed to sea breeze.
- (6) in any other places similar to the above (1)through (5).

**Operational Conditions**

Please use the product within specified values (power supply, temperature, input, output and load condition etc.). Input voltage drops for line impedance, so please make sure that input voltage is within in specified values.

If the product is used over the specified values, it may damage the product, reduce the quality, and even if the products can endure the condition for short time, it may cause degradation of the reliability.

**Note Prior to use**

If you apply high static electricity, voltage higher than rated voltage or reverse voltage to the product, it may cause defects in the products or degrade the reliability.

Please avoid the following items:

1. Over rating power supply, reverse power supply or not-enough connection of input voltage and 0V(DC)line
2. Electrostatic discharge by production line and/or operator
3. Electrified product by electrostatic induction

Do not subject product to excessive mechanical shock. If you drop the product on the floor it might cause a crack to the core of inductors and monolithic ceramic capacitors.

Also please pay attention to handling; the mounted parts can be dislodged if subjected to excessive force.

**Transportation**

If you transport the product, please pack it so that the package will not be damaged by mechanical vibration or mechanical shock, and please educate and guide the carrier to prevent rough handling.

**Note**

1. Please make sure that the product has been evaluated and confirmed against your specifications when it is mounted to your product.
2. All the items and parameters in this product specification have been prescribed on the premise that our product is used for the purpose, under the conditions and in the environment agreed upon between you and us. You are requested not to use our product deviating from such agreement.
3. We consider it not appropriate to include other terms and conditions for transaction warranty in product specifications, drawings or other technical documents. Therefore, if your technical documents as above include such terms and conditions as warranty clause, product liability clause, or intellectual property infringement liability clause, we will not be able to accept such terms and conditions unless they are based on the governmental regulation or they are stated in a separate contract agreement.



This product is subject to the following [operating requirements](#) and the [Life and Safety Critical Application Sales Policy](#):

Refer to: <https://power.murata.com/en/requirements>

Murata Manufacturing Co., Ltd makes no representation that the use of its products in the circuits described herein, or the use of other technical information contained herein, will not infringe upon existing or future patent rights. The descriptions contained herein do not imply the granting of licenses to make, use, or sell equipment constructed in accordance therewith. Spec and cautions are subject to change without notice.  
© 2018 Murata Manufacturing Co., Ltd