

ABAV99W-HF

Reverse Voltage: 75 Volts
 Forward Current: 215 mA
 RoHS Device
 Halogen Free

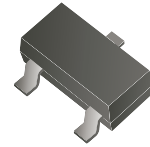

Features

- Fast switching speed.
- High conductance.
- Connected in series.
- Surface mount package ideally suited for automatic insertion.
- AEC-Q101 Qualified.

Mechanical data

- Case: SOT-323, molded plastic.

Circuit Diagram

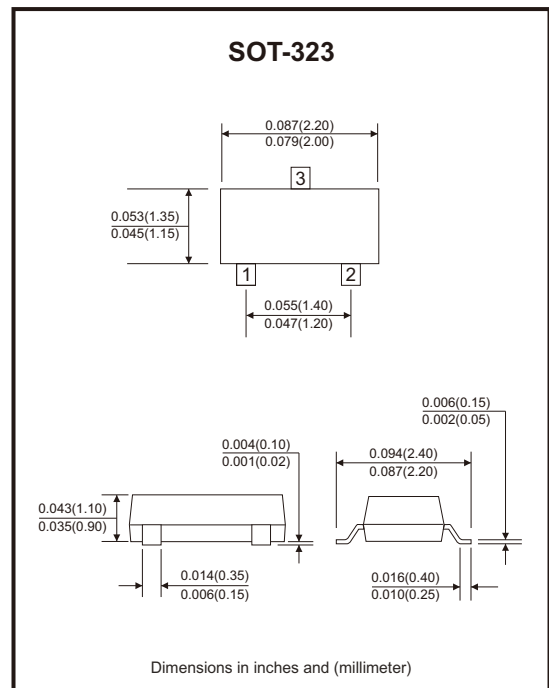
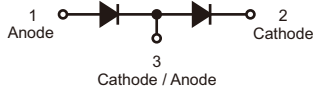

Maximum Rating (at Ta=25°C unless otherwise noted)

Parameter	Symbol	Value	Unit
Repetitive peak reverse voltage	V _{RRM}	75	V
DC reverse voltage	V _R	75	V
RMS reverse voltage	V _{R(RMS)}	53	V
Non-repetitive forward surge current	I _{FSM}	@ t=1.0s	0.5
		@ t=1.0ms	1.0
		@ t=1.0µs	2.0
Peak forward surge current (Note 1)	I _{FM(surge)}	300	mA
Repetitive peak forward surge current	I _{FRM}	450	mA
Forward continuous current	I _F	215	mA
Average rectified forward current (averaged over any 20ms period)	I _{F(AV)}	715	mA
Power dissipation	P _D	200	mW
Thermal resistance junction to ambient	R _{θJA}	625	°C/W
Operating and storage temperature range	T _J , T _{STG}	-65 to +150	°C

Notes: 1. Device mounted on FR-4 PC board with recommended pad layout.

Company reserves the right to improve product design, functions and reliability without notice.

REV:A

Electrical Characteristics (at Ta=25°C unless otherwise noted)

Parameter	Symbol	Conditions	Min	Max	Unit
Reverse breakdown voltage	$V_{(BR)}$	$I_{(BR)} = 100\mu A$	75		V
Reverse voltage leakage current	I_R	$V_R = 75V$		2.5	μA
Forward voltage	V_F	$I_F = 1mA$ $I_F = 10mA$ $I_F = 50mA$ $I_F = 150mA$		715 855 1000 1250	mV
Diode capacitance	C_D	$V_R = 0V, f = 1MHz$		1.5	pF
Reverse recovery time	t_{rr}	$I_F = I_R = 10mA, R_L = 100\Omega$		6.0	nS
Forward recovery voltage	V_{FR}	$I_F = 10mA, t_r = 20ns$		1.75	V

Rating and Characteristic Curves (ABAV99W-HF)

Fig.1 - Forward Voltage

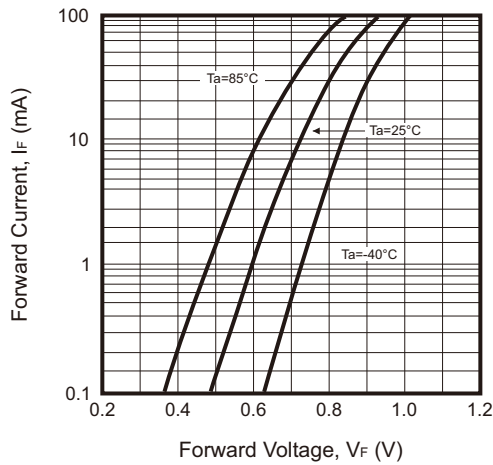

Fig.2 - Leakage Current

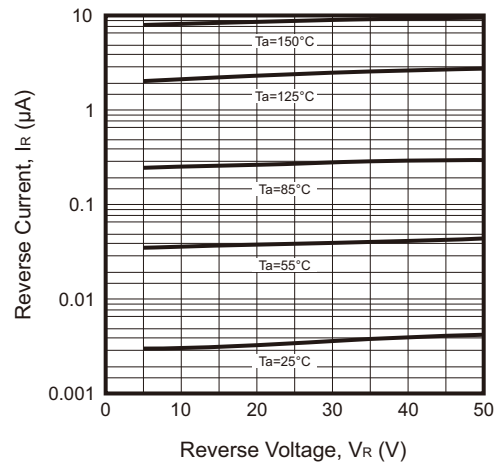
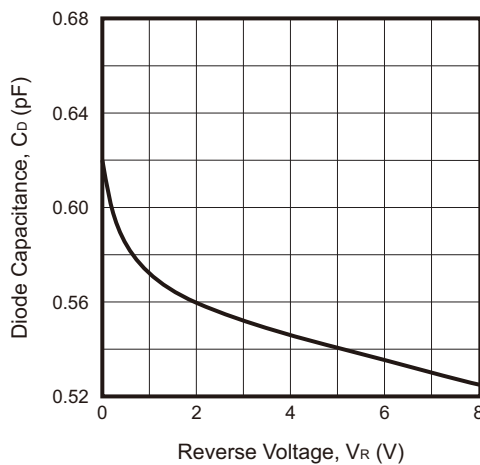

Fig.3 - Capacitance



Company reserves the right to improve product design, functions and reliability without notice.

REV:A

Reel Taping Specification

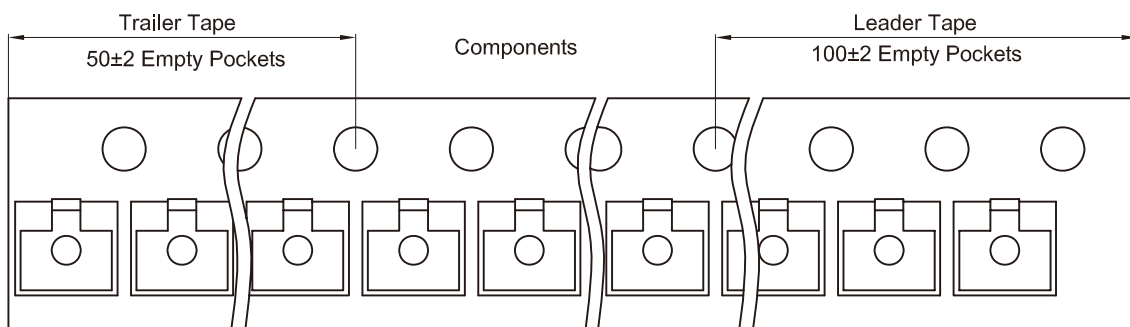
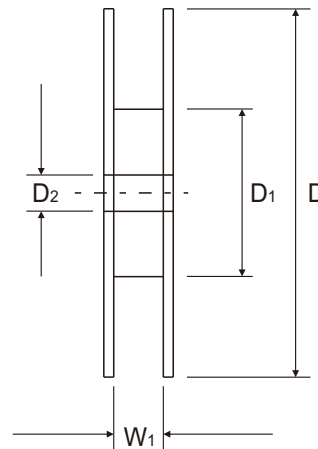
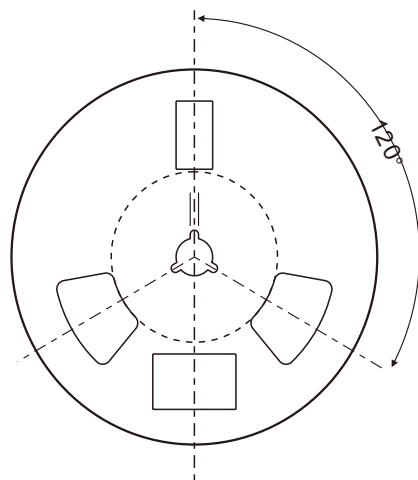
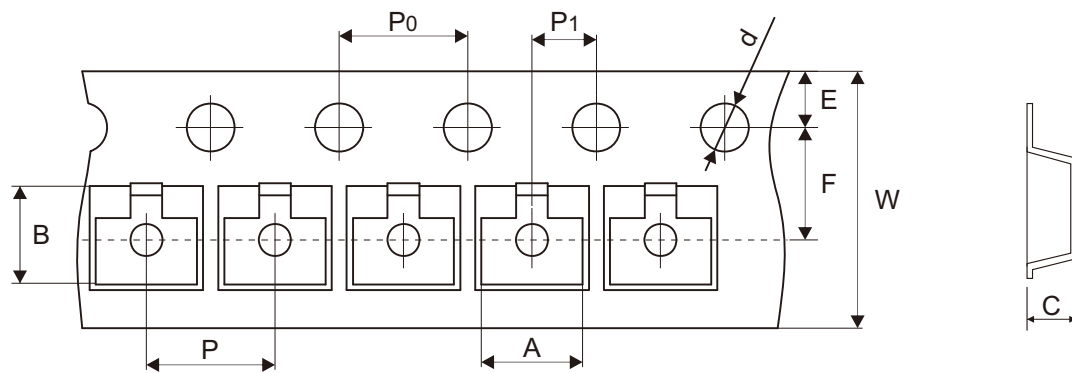

SOT-323	SYMBOL	A	B	C	d	D	D1	D2
	(mm)	2.25 ± 0.10	2.55 ± 0.10	1.20 ± 0.10	1.50 ± 0.10	178.00 ± 1.00	54.00 ± 0.50	13.00 ± 0.50
	(inch)	0.089 ± 0.004	0.100 ± 0.004	0.047 ± 0.004	0.059 ± 0.004	7.008 ± 0.039	2.126 ± 0.020	0.512 ± 0.020

SOT-323	SYMBOL	E	F	P	P0	P1	W	W1
	(mm)	1.75 ± 0.10	3.50 ± 0.05	4.00 ± 0.10	4.00 ± 0.10	2.00 ± 0.05	8.00 + 0.30 - 0.10	9.50 ± 1.00
	(inch)	0.069 ± 0.004	0.138 ± 0.002	0.157 ± 0.004	0.157 ± 0.004	0.079 ± 0.002	0.315 + 0.012 - 0.004	0.374 ± 0.039

Company reserves the right to improve product design, functions and reliability without notice.

REV:A

Marking Code

Part Number	Marking Code
ABAV99W-HF	KJG



Suggested PAD Layout

SIZE	SOT-323	
	(mm)	(inch)
A	0.90	0.035
B	0.70	0.028
C	1.30	0.051
D	1.90	0.075

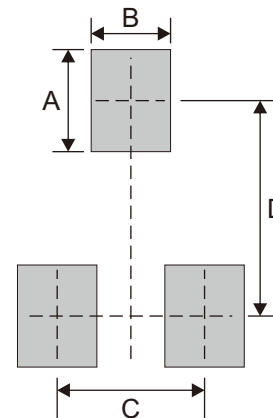

Note: 1. The pad layout is for reference purposes only.

Standard Packaging

Case Type	REEL PACK	
	REEL (pcs)	Reel Size (inch)
SOT-323	3,000	7