

**General information**

Part number	S11MA7-P05MJG0-3920
Termination	solder
Size	1
Locking principle	push
Coding	a_key_medi
Cable Diameter	cable_medi_39
Cable outlet	standard

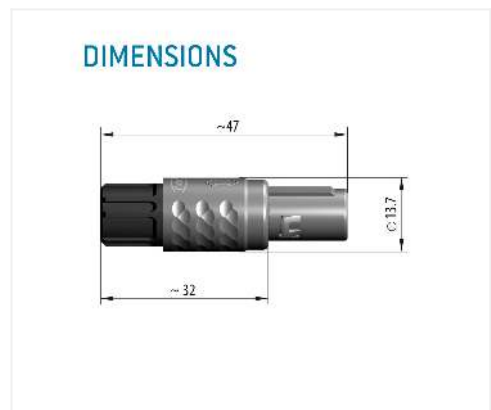

**Contact insert description**

Number of contacts	5
Contact type	pins
Contact diameter	09mm
Insulator material	peek
Wire cross section	22_awg
Termination	solder
Termination diameter	085mm

reverse\_gender\_on\_request

**Technical information**

Max. creepage and air clearance distance	08_mm	iec_60601_2mopp_2moop
Nominal current single contact	075_a	iec_60512_5_2
Nominal current insert	5,625 A	vde_0298_4
Test voltage	16_kv_dc	sae_13441

safety\_text  
 iec\_60601\_plug

## Mechanical and environmental data

Degree of protection*	ip50
Operating temperature	50_120_c
Mating cycles	2000

mated\_unmated

## Insulator materials MEDI-SNAP®

psu\_peek

## Material and surface treatments

Housing	psu_gray
Color option	red
Contact	cu_alloy_gold

safety\_text\_2  
ul\_text  
illustrative\_text