

DS18 Series Sensors



Datasheet

Miniature self-contained photoelectric sensors in a universal housing



- Multiple mounting options accommodate almost any mounting requirements
- Exceptional optical performance, comparable to larger “MINI-style” or barrel sensors
- Patented wide-beam retroreflective models for enhanced ease of alignment
- 10 to 30V dc operation, with solid-state complementary NPN or PNP outputs, light operate or dark operate, depending on model
- Bright output LED indicates object is within the sensor’s field of view
- Rugged sealed housing with protected circuitry, rated IP67/NEMA 6
- All models feature 18 mm threaded barrel and base for easy, versatile mounting
- Choose 2 m (6.5 ft) or 9 m (30 ft) cable, or 4-pin Euro-style or Pico-style integral QD fitting or 150 mm (6 in) QD

Patent(s) issued or pending



WARNING: Not To Be Used for Personnel Protection

Never use this device as a sensing device for personnel protection. Doing so could lead to serious injury or death. This device does not include the self-checking redundant circuitry necessary to allow its use in personnel safety applications. A sensor failure or malfunction can cause either an energized or de-energized sensor output condition.

Models

Model ¹	Sensing Mode	Sensing Beam	Range	Output
DS186E	Opposed	Infrared, 940 nm Effective Beam: 13 mm (0.5 in)	20 m (65.6 ft)	N/A
DS18VN6R				NPN
DS18VP6R				PNP
DS18VN6LP	Polarized Retroreflective	Visible red, 660 nm	3.5 m (11.4 ft)	NPN
DS18VP6LP				PNP
DS18VN6LPW	Wide-Angle Polarized Retroreflective	Visible red, 660 nm	3.0 m (9.8 ft)	NPN
DS18VP6LPW				PNP
DS18VN6FF50	Fixed-Field	Visible red, 660 nm	50 mm (2 in)	NPN
DS18VP6FF50				PNP
DS18VN6FF100			100 mm (4 in)	NPN
DS18VP6FF100				PNP

¹

- Only standard 2 m (6.5 ft) cable models are listed. For 9 m (30 ft) cable, add suffix “W/ 30” to the model number (for example, DS186E W/30)
- For 4-pin integral Euro-style QD, add suffix “Q8” (for example, DS186EQ8)
- For 4-pin integral Pico-style QD, add suffix “Q7” (for example, DS186EQ7)
- For 4-pin Euro-style 150 mm (6 in) pigtail QD, add suffix “Q5” (for example, DS186EQ5)
- For 4-pin Pico-style 150 mm (6 in) pigtail QD, add suffix “Q” (for example, DS186EQ)



Wiring Diagrams

NPN (Sinking) Outputs

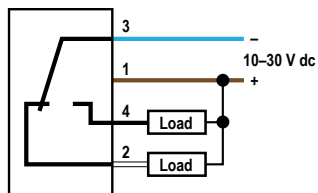

PNP (Sourcing) Outputs

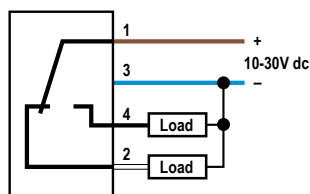

Emitters

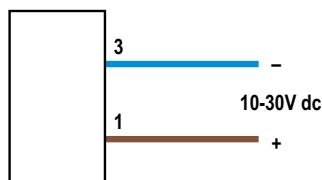

Key

- 1 = Brown
- 2 = White
- 3 = Blue
- 4 = Black

Specifications

Supply Voltage

10 to 30 V dc (10% maximum ripple) at less than 20 mA, exclusive of load
Protected against reverse polarity and transient voltages

Output Response Time

Opposed Mode: 800 microseconds ON; 400 microseconds OFF
All others: 2 milliseconds ON/OFF



NOTE: 100 millisecond delay on power-up; outputs do not conduct during this time

Repeatability

Opposed Mode: 100 microseconds
All others: 350 microseconds

Indicators

2 LED indicators
Green solid: Power ON
Yellow (back cover) ON: Black wire (pin 4) is conducting; an object is within sensor's field of view

Connections

2 m (6.5 ft) 4-wire PVC cable, 9 m (30 ft) 4-wire PVC cable, 4-pin Pico-style integral QD, 4-pin Euro-style integral QD, 4-pin Pico-style Pigtail QD, or 4-pin Euro-style Pigtail QD, depending on model

Application Notes

NPN off-state leakage current is < 200 μ A for load resistances > 3 k Ω or optically isolated loads. For load current of 100 mA, leakage is < 1% of load current.

Operating Conditions

Temperature: -20 °C to +70 °C (-4 °F to +158 °F)
90% at +50 °C maximum relative humidity (non-condensing)

Environmental Rating

IEC IP67; NEMA 6; UL Type 1

Certifications



Output Configuration

Solid-state complementary; NPN or PNP (current sinking or sourcing), depending on model
Rating:

100 mA combined load from -20 °C to +60 °C (-4 °F to +140 °F)
Linearly derate combined load from 100 to 50 mA at temperatures from +60 °C to 70 °C (140 °F to 158 °F)

Off-state leakage current:

NPN: less than 200 μ A @ 30 V dc (See the Application Note)
PNP: less than 10 μ A @ 30 V dc

ON-state saturation voltage:

NPN: < 1.6 V @ 100 mA
PNP: < 3 V @ 100 mA

Protected against false pulse on power-up and continuous overload or short circuit of outputs

Construction

ABS housing, 3 mm mounting hardware included

Required Overcurrent Protection



WARNING: Electrical connections must be made by qualified personnel in accordance with local and national electrical codes and regulations.

Overcurrent protection is required to be provided by end product application per the supplied table.
Overcurrent protection may be provided with external fusing or via Current Limiting, Class 2 Power Supply.
Supply wiring leads < 24 AWG shall not be spliced.
For additional product support, go to www.bannerengineering.com.

Supply Wiring (AWG)	Required Overcurrent Protection (Amps)
20	5.0
22	3.0
24	2.0
26	1.0
28	0.8
30	0.5

Dimensions

All measurements are listed in millimeters [inches], unless noted otherwise.

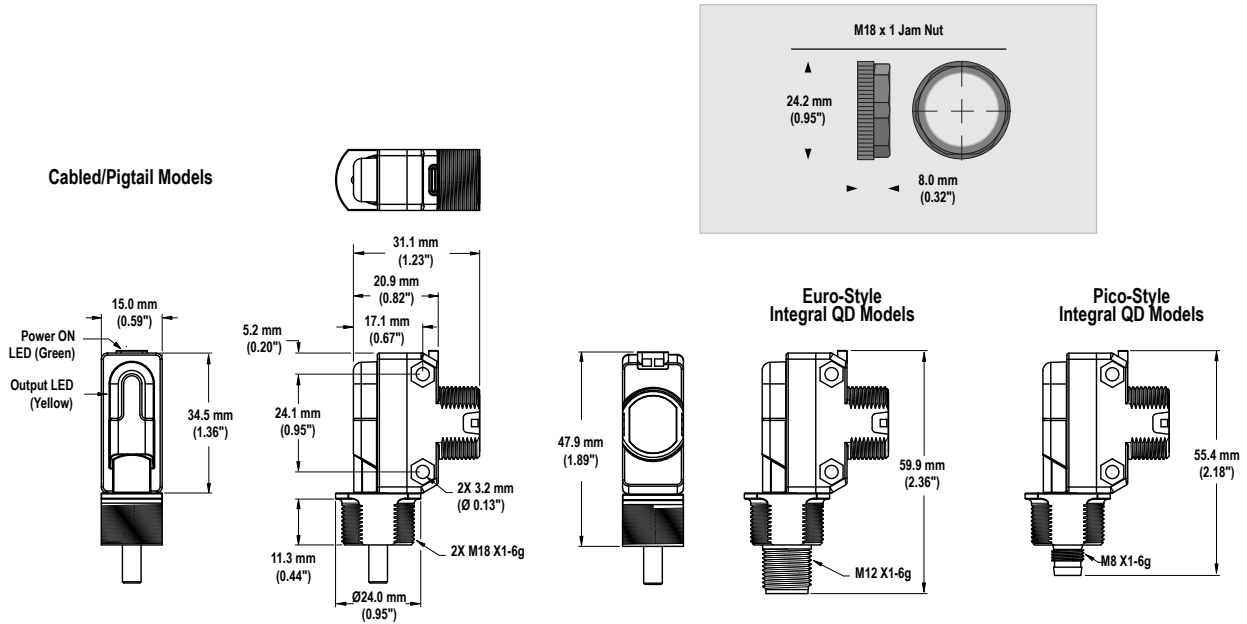

Performance Curves

Performance based on a 90% reflectance white test card

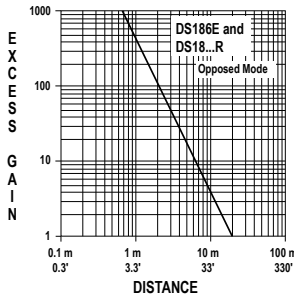

Figure 1. Opposed Mode—Excess Gain

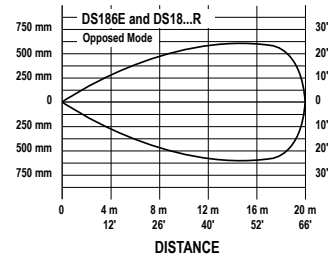

Figure 2. Opposed Mode—Beam Pattern

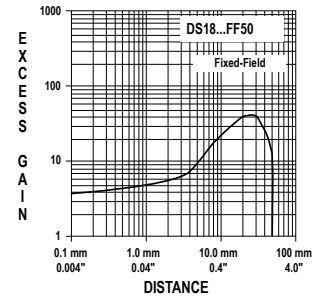

Figure 3. Fixed-Field 50 mm—Excess Gain

Performance based on a 90% reflectance white test card

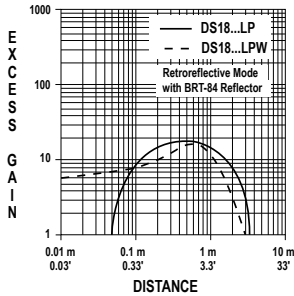

Figure 4. Polarized Retroreflective—Excess Gain

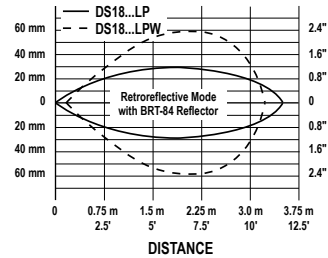

Figure 5. Polarized Retroreflective—Beam Pattern

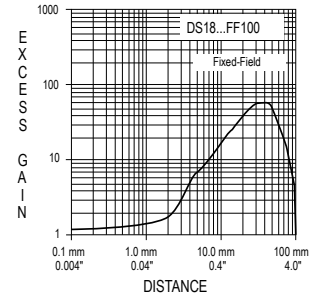
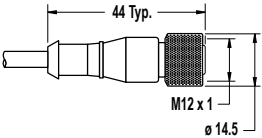
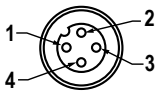
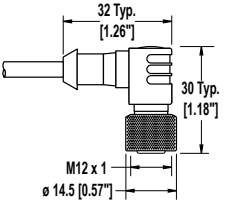
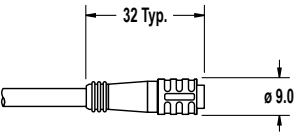
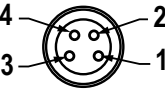
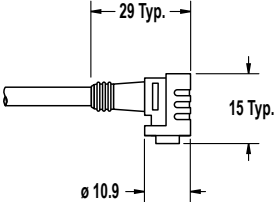

Figure 6. Fixed-Field 100 mm—Excess Gain

Accessories

4-Pin Threaded M12/ Euro-Style Cordsets				
Model	Length	Style	Dimensions	Pinout (Female)
MQDC-406	1.83 m (6 ft)	Straight		 <p>1 = Brown 2 = White 3 = Blue 4 = Black</p>
MQDC-415	4.57 m (15 ft)			
MQDC-430	9.14 m (30 ft)			
MQDC-450	15.2 m (50 ft)			
MQDC-406RA	1.83 m (6 ft)	Right-Angle		
MQDC-415RA	4.57 m (15 ft)			
MQDC-430RA	9.14 m (30 ft)			
MQDC-450RA	15.2 m (50 ft)			

4-Pin Snap-on M8/ Pico-Style Cordsets				
Model	Length	Style	Dimensions	Pinout (Female)
PKG4-2	2 m (6.56 ft)	Straight		 <p>1 = Brown 2 = White 3 = Blue 4 = Black</p>
PKW4Z-2	2 m (6.56 ft)	Right-Angle		

Mounting Brackets

SMB18A

- Right-angle mounting bracket with a curved slot for versatile orientation
- 12-ga. stainless steel
- 18 mm sensor mounting hole
- Clearance for M4 (#8) hardware

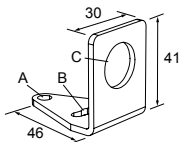

Hole center spacing: A to B = 24.2
Hole size: A = ø 4.6, B = 17.0 × 4.6, C = ø 18.5

See <http://www.bannerengineering.com> for additional 18 mm barrel mounting bracket options.

Retroreflectors

See <http://www.bannerengineering.com> for complete information on retroreflectors.



NOTE: Polarized sensors require corner cube-type retroreflectors.

Banner Engineering Corp. Limited Warranty

Banner Engineering Corp. warrants its products to be free from defects in material and workmanship for one year following the date of shipment. Banner Engineering Corp. will repair or replace, free of charge, any product of its manufacture which, at the time it is returned to the factory, is found to have been defective during the warranty period. This warranty does not cover damage or liability for misuse, abuse, or the improper application or installation of the Banner product.

THIS LIMITED WARRANTY IS EXCLUSIVE AND IN LIEU OF ALL OTHER WARRANTIES WHETHER EXPRESS OR IMPLIED (INCLUDING, WITHOUT LIMITATION, ANY WARRANTY OF MERCHANTABILITY OR FITNESS FOR A PARTICULAR PURPOSE), AND WHETHER ARISING UNDER COURSE OF PERFORMANCE, COURSE OF DEALING OR TRADE USAGE.

This Warranty is exclusive and limited to repair or, at the discretion of Banner Engineering Corp., replacement. IN NO EVENT SHALL BANNER ENGINEERING CORP. BE LIABLE TO BUYER OR ANY OTHER PERSON OR ENTITY FOR ANY EXTRA COSTS, EXPENSES, LOSSES, LOSS OF PROFITS, OR ANY INCIDENTAL, CONSEQUENTIAL OR SPECIAL DAMAGES RESULTING FROM ANY PRODUCT DEFECT OR FROM THE USE OR INABILITY TO USE THE PRODUCT, WHETHER ARISING IN CONTRACT OR WARRANTY, STATUTE, TORT, STRICT LIABILITY, NEGLIGENCE, OR OTHERWISE.

Banner Engineering Corp. reserves the right to change, modify or improve the design of the product without assuming any obligations or liabilities relating to any product previously manufactured by Banner Engineering Corp. Any misuse, abuse, or improper application or installation of this product or use of the product for personal protection applications when the product is identified as not intended for such purposes will void the product warranty. Any modifications to this product without prior express approval by Banner Engineering Corp will void the product warranties. All specifications published in this document are subject to change; Banner reserves the right to modify product specifications or update documentation at any time. Specifications and product information in English supersede that which is provided in any other language. For the most recent version of any documentation, refer to: www.bannerengineering.com.