

Features
<ul style="list-style-type: none"> GPS, GSM & WIFI Outdoor Antenna 50 Ohm Impedance Stable And Reliable Performance 1575.42MHz, 700~960/1710~2700MHz

Applications
<ul style="list-style-type: none"> Vehicle Tracking Asset Tracking GPS Navigation Machine To Machine Communication

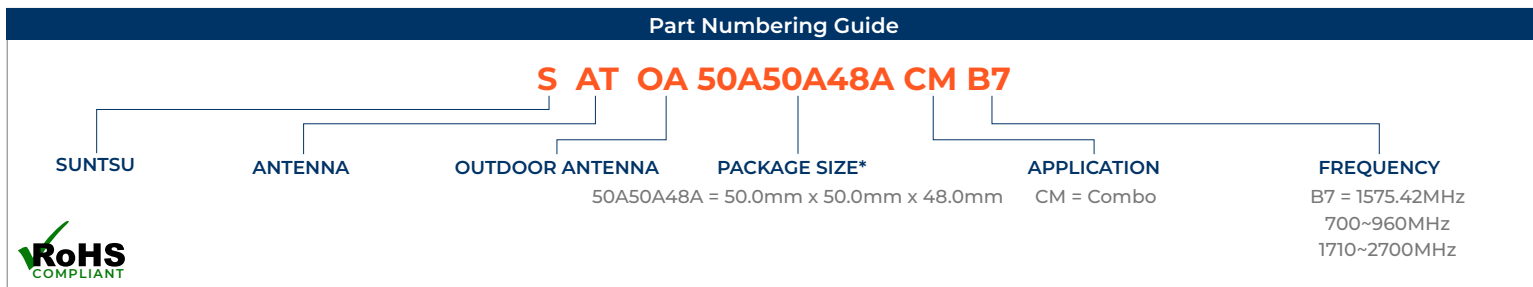

Electrical Parameters (GPS)	Units	Minimum	Typical	Maximum	Remarks
Frequency Band	MHz	1570.42	1575.42	1580.42	±1MHz
Impedance	Ω		50		
Polarization			RHCP		
Axial Ratio	dB			3	
Peak Gain	dBi		2		For Dielectric Antenna
VSWR				1.5	For Dielectric Antenna
Peak Gain	dBi	26	28	30	For LNA Antenna
VSWR				2	For LNA Antenna
Noise Figure				1.5	For LNA Antenna
Ex-band Attenuation @1525.42MHz	dB		16		For LNA Antenna
Ex-band Attenuation @1625.42MHz	dB		12		For LNA Antenna
Supply Voltage	V DC	2.2		5	For LNA Antenna
Current Consumption	mA	5		15	For LNA Antenna

Electrical Parameters (GSM)	Units	Minimum	Typical	Maximum	Remarks
Frequency Band	MHz	700		960	
Frequency Band	MHz	1710		2700	
Impedance	Ω		50		
Polarization			Linear		
Peak Gain	dBi		2		At Center Frequency
VSWR				2	At Center Frequency

Environmental Specifications		Mechanical Specifications	
Operating Temperature	-40°C ~ 85°C	Cable	RG174
Relative Humidity	Up to 95%	Connector	SMA/MCX/FAKRA or Others
Ingress Protection	IP67 (exclude cable outlet)	Material	ABS
Vibration	10 to 55Hz with 1.5mm amplitude 2 hours	Mounting Method	Screw

Outline Drawing

All dimensions are in millimeters (mm) unless otherwise noted. Drawings are not to scale.

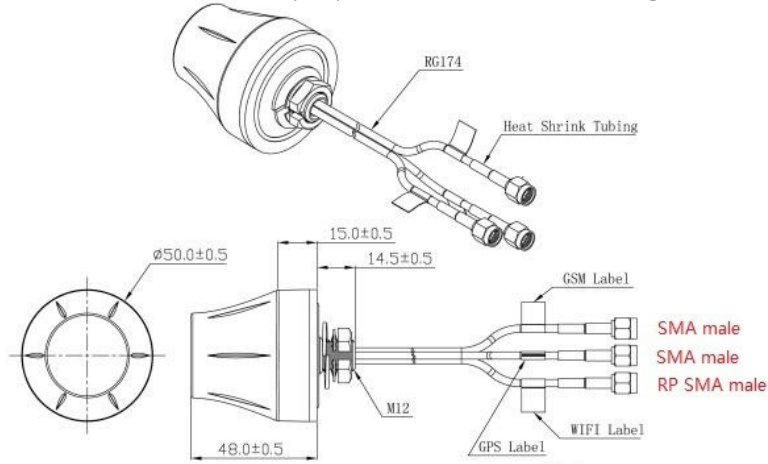

Radiation Pattern (GPS XY)

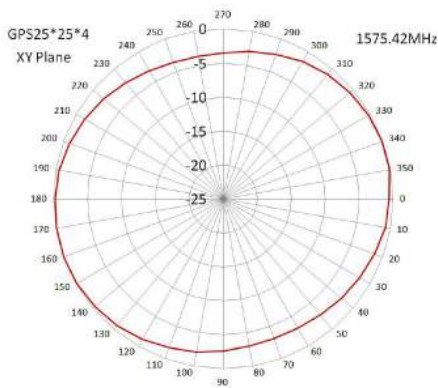

Radiation Pattern (GPS XZ)

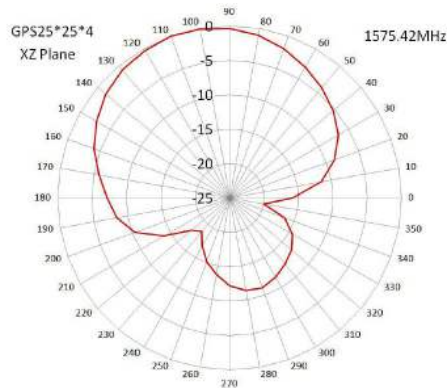

Radiation Pattern (GPS YZ)

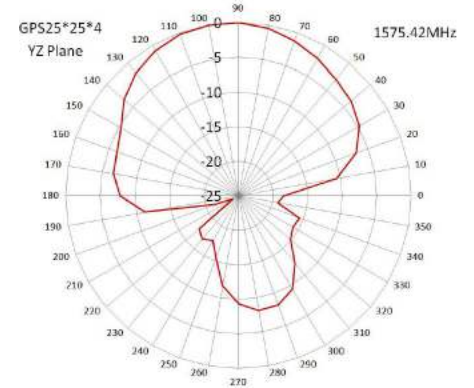

Radiation Pattern (GSM XY)

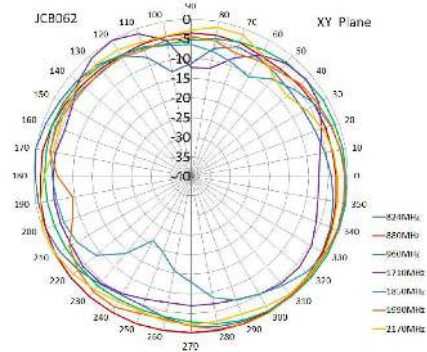

Radiation Pattern (GSM XZ)

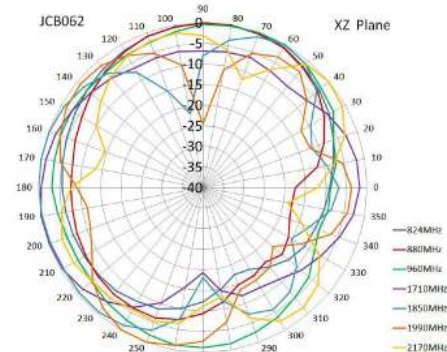

Radiation Pattern (GSM YZ)

