



**SERIES: 15 W MULTI-BLADE**

**DESCRIPTION: SWITCHING POWER SUPPLY**

**FEATURES**

- universal AC input
- regulated output voltage
- interchangeable input blades
- short circuit, over load protection
- meets EISA / efficiency level IV regulations
- custom designs available



**MODEL**

MODEL	output voltage	output current		output wattage	ripple*	efficiency level	cord length (mm)
	nominal (V dc)	min (A)	max (A)	max (W)	max. (mVp-p)		
EMS050260	5	0	2.6	13	150	IV	1830 +150/-0
EMS060250	6	0	2.5	15	150	IV	1830 +150/-0
EMS070214	7	0	2.14	15	150	IV	1830 +150/-0
EMS090170	9	0	1.7	15.3	150	IV	1830 +150/-0
EMS120125	12	0	1.25	15	150	IV	1830 +150/-0
EMS150100	15	0	1	15	150	IV	1830 +150/-0
EMS180084	18	0	0.84	15.3	150	IV	1830 +150/-0
EMS200075	20	0	0.75	15	150	IV	1830 +150/-0
EMS240063	24	0	0.63	15.1	150	IV	1830 +150/-0

\*at full load, 100 ~ 240 V ac input, measured at 20MHz bandwidth with a 10 uF electrolytic cap and a 0.1 uF ceramic cap on the output

**PART NUMBER KEY**

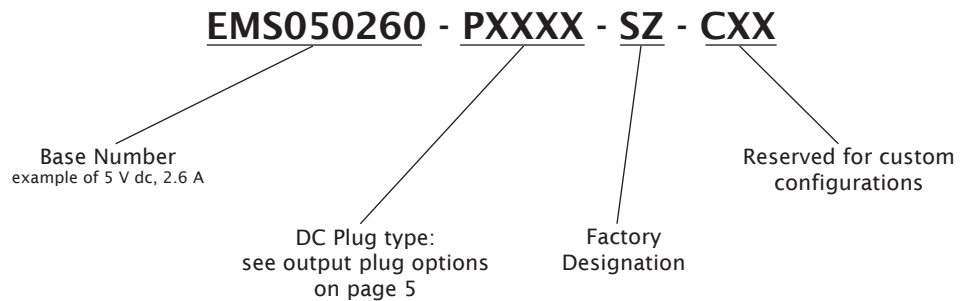



**SERIES: 15 W MULTI-BLADE**

**DESCRIPTION: SWITCHING POWER SUPPLY**

## INPUT

parameter	conditions/description	min	nom	max	units
rated input voltage		100		240	V ac
input voltage range		90		255	V ac
rated frequency		50		60	Hz
frequency range		47		63	Hz
rated input current				0.6	A
inrush current	115 V ac, full load, cold start, 25°C 230 V ac, full load, cold start, 25°C			30 60	A A
no load power consumption	100 ~ 240 V ac input			0.3	W

## OUTPUT

parameter	conditions/description	min	nom	max	units
line regulation			±1		%
load regulation			±5		%
over voltage protection	output shut down	110%		140%	V dc
short circuit protection	output shut down and auto-restart				

## SAFETY & EMI

parameter	conditions/description	min	nom	max	units
HI-POT	input to output at 10 mA for 1 second			3000 4242	V ac V ac
insulation resistance	input to output at 500 V dc	100			MΩ
safety approvals	UL/cUL, CB (IEC60950-1), CE (GS/TUV EN60950-1)				
EMI standard	FCC part 15 class B, CE (EN55022, EN55024)				
leakage current				0.25	mA
RoHS compliant	yes				

## ENVIRONMENTAL

parameter	conditions/description	min	nom	max	units
operating temperature		0		40	°C
operating humidity		20		80	%
storage temperature		-10		70	°C
storage humidity		10		90	%



SERIES: 15 W MULTI-BLADE

DESCRIPTION: SWITCHING POWER SUPPLY

**MECHANICAL DRAWING**

input plug	interchangeable input blade (UL, UK, VDE, SAA)
case size	74 L x 43.5 W x 34 H mm tolerance: $\pm 1$ mm

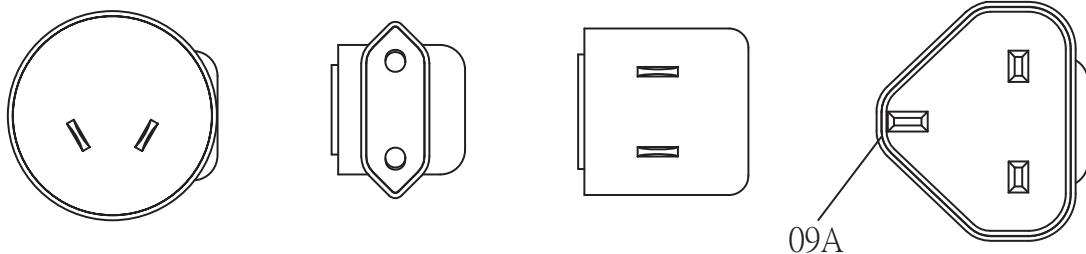
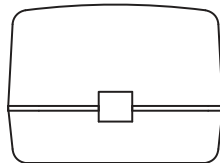
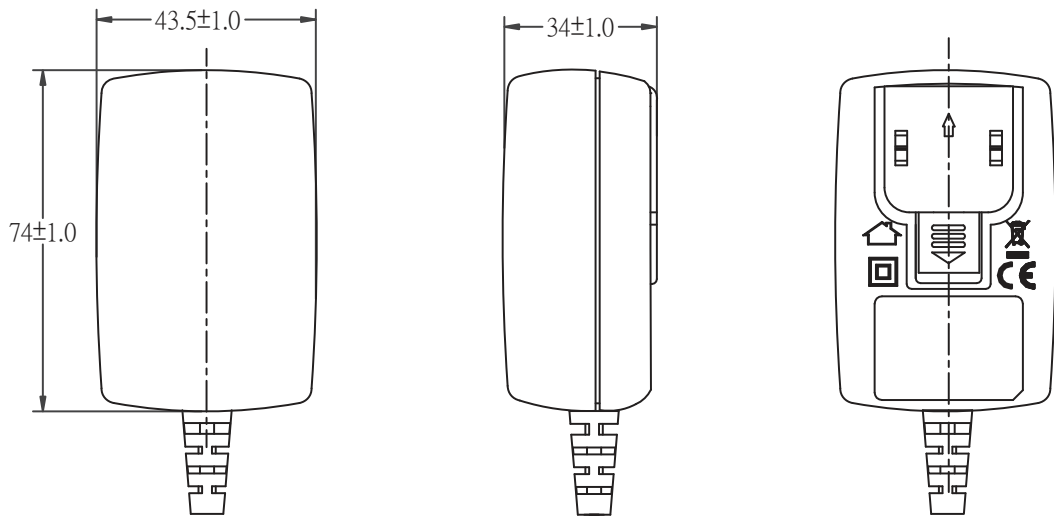



SERIES: 15 W MULTI-BLADE

DESCRIPTION: SWITCHING POWER SUPPLY

DC CORD

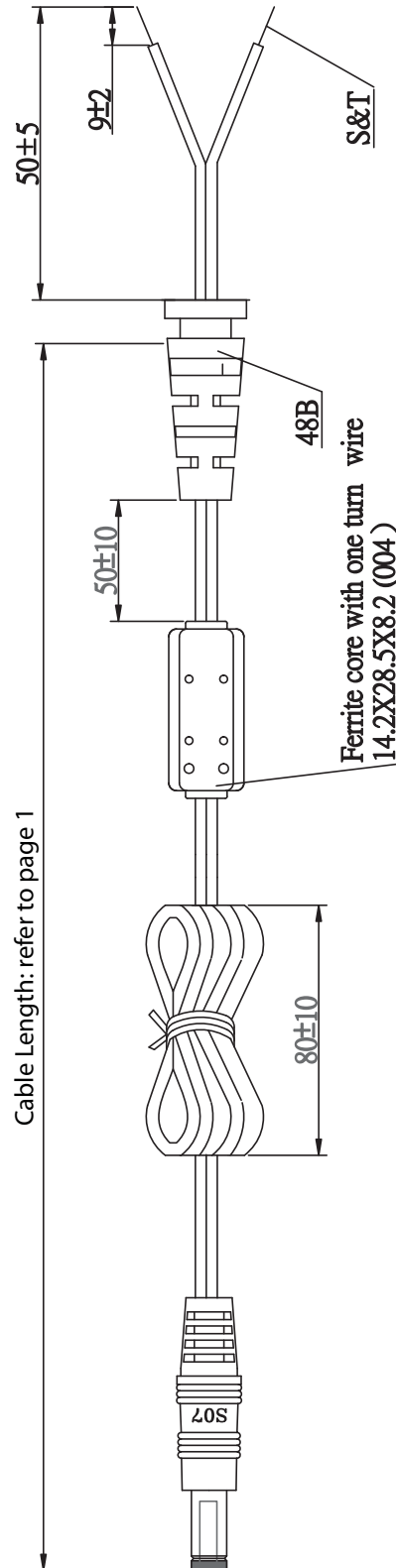

Cable Gauge	
EMS050260	18 AWG
EMS060250	18 AWG
EMS070214	18 AWG
EMS090170	20 AWG
EMS120125	20 AWG
EMS150100	20 AWG
EMS180084	20 AWG
EMS200075	20 AWG
EMS240063	20 AWG



SERIES: 15 W MULTI-BLADE

DESCRIPTION: SWITCHING POWER SUPPLY

## OUTPUT PLUG OPTIONS

### 3.5 mm Phono Plug

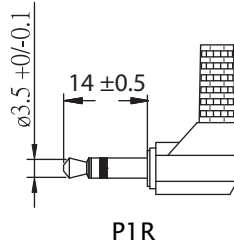
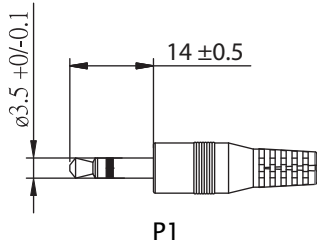

\*Tip positive

### Standard DC Plug

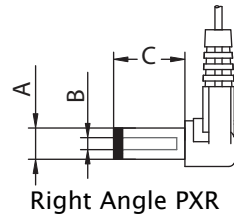
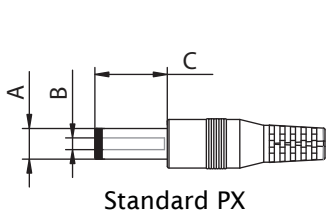

	A	B	C	Unit
P5/P5R	5.5	2.1	12	mm
P6/P6R	5.5	2.5	12	mm
P7/P7R	3.5	1.3	9.5	mm
P8/P8R	3.8	1.35	9.5	mm
P9/P9R	3.8	1.05	9.5	mm

### Locking DC Plug

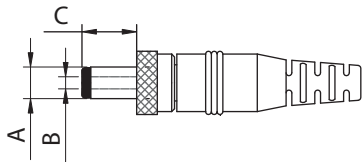

	A	B	C	Unit
P10	5.5	2.1	9.5	mm
P11	5.5	2.5	9.5	mm

### EIAJ Plugs

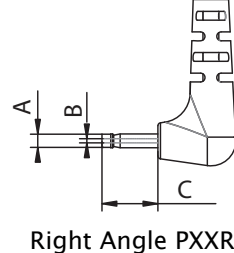
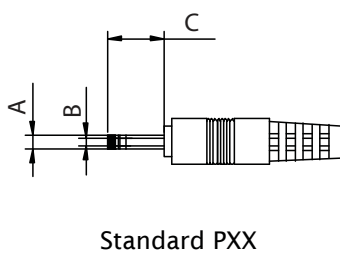

	EIAJ	A	B	C	D	Unit
P12/P12R	EIAJ-1	2.35	0.7	9.5	NA	mm
P13/P13R	EIAJ-2	4.0	1.7	9.5	5.0	mm
P14/P14R	EIAJ-3	4.75	1.7	9.5	5.0	mm

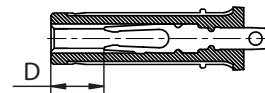

### PART NUMBER GUIDE

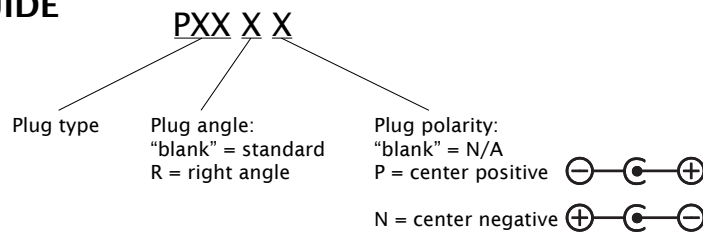

\*Contact CUI for additional output plug options.



SERIES: 15 W MULTI-BLADE

DESCRIPTION: SWITCHING POWER SUPPLY

INDIVIDUAL PACKAGING

tolerance  $\pm 1$  mm

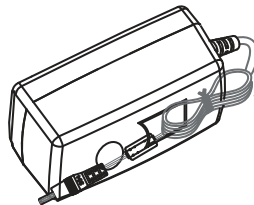
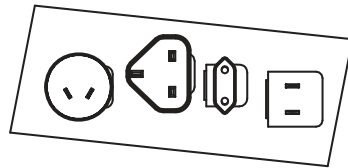
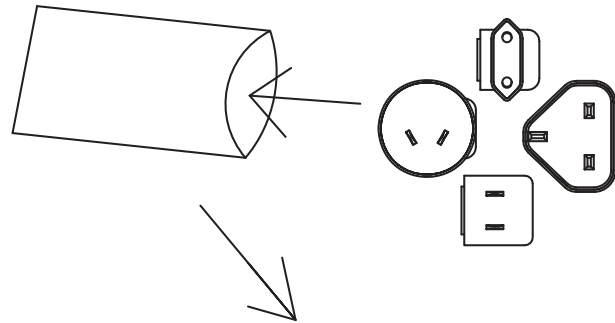

RoHS Compliant  
 $50 \pm 1$   
 $10 \pm 1$

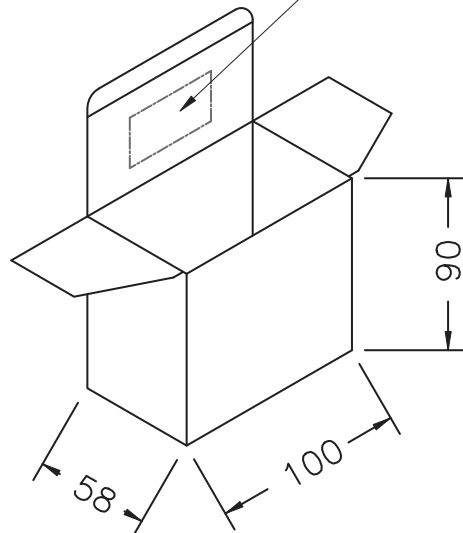



SERIES: 15 W MULTI-BLADE

DESCRIPTION: SWITCHING POWER SUPPLY

**PACKAGING**

tolerance +7 / -0 mm

CARTON SIZE: 485X428X210mm

Q'TY: 60pcs(20x3x1)

**RoHS Compliant**

