

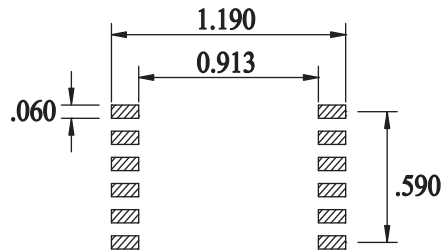

# EFD20 Transformer AEFD20-4073

Dimension Unit: Inch

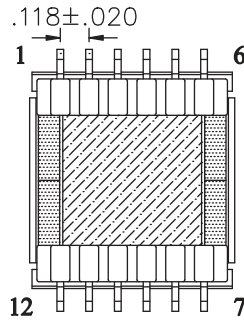
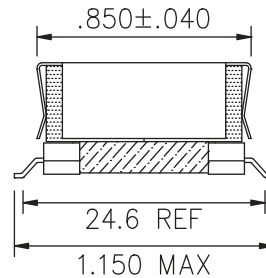
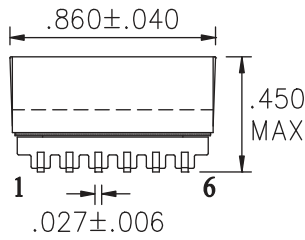
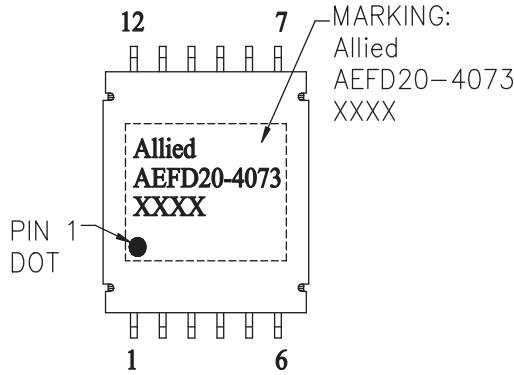

NOTE:  
 1.Pin 1 Dot.  
 2.Pin 6 add teflon tube.  
 3.CORE add clip.

## Construction

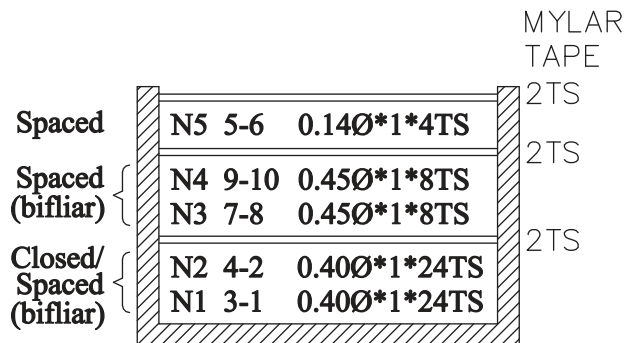

## Schematic

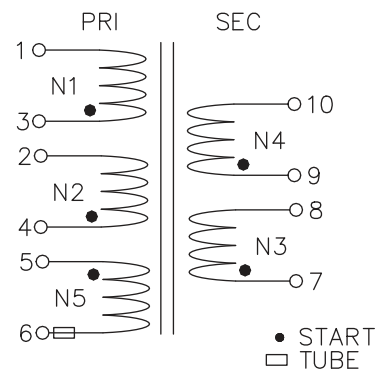

All specifications subject to change without notice.

**Electrical Specifications: @25°C Test**

1. INDUCTANCE: 10KHz/1V (MICROTEST-6377)

3 - 1 : 112  $\mu$ H  $\pm$ 10%

4 - 2 : 112  $\mu$ H  $\pm$ 10%

2. LEAKING INDUCTANCE: 100KHz/1V (MICROTEST-6377)

(3+4) - (1+2) : 1.5  $\mu$ H MAX. (SHORTED PIN 5+6+7+8+9+10 )

3. DCR: CH-502A @25°C

3 - 1 : 150 mOHM MAX.

4 - 2 : 150 mOHM MAX.

5 - 6 : 300 mOHM MAX.

7 - 8 : 50 mOHM MAX.

9 - 10 : 50 mOHM MAX.

4. HI-POT TEST :

PRI TO SEC : AC 1500V 3mA FOR 3 SECOND.

5. GAP : CORE CENTER GAP.

6. OPERATION TEMP RANGE : -40°C ~ +85°C including temp rise.