



# **ORIENT DISPLAY**

Your Total LCD Solution Provider

## Specification for LCD Module

### **AFY480272A0-4.3INTH**

Revision D



A	Orient Display
FY	TFT Type
480272	Resolution 480 x 272
A0	Serial A0
4.3	4.3", Module Dimension 105.40 x 67.10 x 2.95 mm
I	IPS Display
N	Top: -20~+70°C; Tstr: -30~+80°C
T	Transmissive
H	High Brightness, 1000 cd/m2
/	No Touch Panel
/	Controller <a href="#">SC7283-G4</a> Or Compatible
/	RGB 24bit Interface





## CONTENTS

1. GENERAL INFORMATION .....	3
2. ABSOLUTE MAXIMUM RATINGS.....	3
3. ELECTRICAL CHARACTERISTICS.....	4
4. BACKLIGHT CHARACTERISTICS .....	4
5. EXTERNAL DIMENSIONS .....	5
6. ELECTRO-OPTICAL CHARACTERISTICS.....	6
7. INTERFACE DESCRIPTION.....	8
8.AC CHARACTERISTICS .....	9
9. POWER SEQUENCE.....	11
10. RELIABILITY TEST CONDITIONS.....	12
11.INSPECTION CRITERION .....	13
12. HANDLING PRECAUTIONS .....	13
13. PRECAUTION FOR USE.....	14
14. PACKING SPECIFICATION.....	14
15. HSF COMPLIANCE .....	14

# 1. GENERAL INFORMATION

No.	Item	Contents	Unit
1	LCD size	4.3 inch (Diagonal)	/
2	Display mode	IPS/Normally black/Transmissive	/
3	Viewing direction(eye)	Free	/
4	Gray scale inversion direction	-	/
5	Resolution(H*V)	480 *272 Pixels	/
6	Module size (L*W*H)	105.40*67.10*2.95	mm
7	Active area (L*W)	95.04*53.86	mm
8	Pixel pitch (L*W)	0.198*0.198	mm
9	Interface type	RGB 24bit interface	/
10	Color Depth	16.7M	/
11	Module power consumption	0.852	W
12	Back light type	White LED	/
13	Driver IC	SC7283-G4 OR COMPATIBLE	/
14	Weight	41.2	G

# 2. ABSOLUTE MAXIMUM RATINGS

Item	Symbol	Min.	Max.	Unit	Note
Power supply input voltage for TFT	VDD	-0.3	5.0	V	
Backlight current (normal temp.)	ILED	-	50	mA	
Operation temperature	Top	-20	+70	°C	Note1
Storage temperature	Tst	-30	+80	°C	Note1
Humidity	RH	-	90%	RH	Note1

Note1 :

- 1).The relative humidity and temperature range are as below sketch,90%RH Max.
- 2).The maximum wet bulb temperature  $\leq 40^{\circ}\text{C}$  and without dewing.

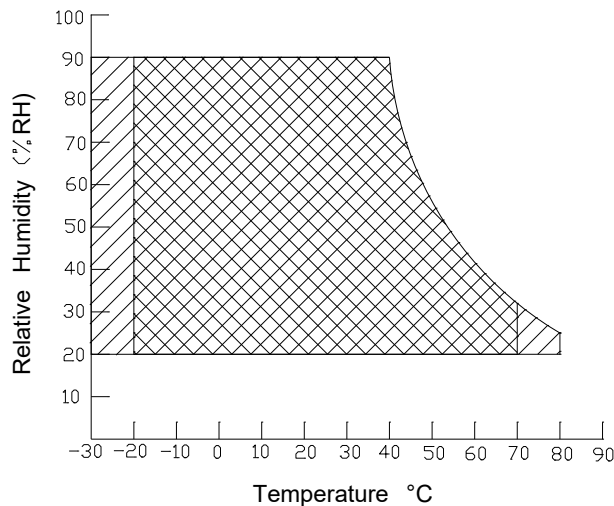

Operating Range  Storage Range  + 

### 3. ELECTRICAL CHARACTERISTICS

#### DC CHARACTERISTICS(at Ta=25°C)

Item	Symbol	Min.	Typ.	Max.	Unit	Note
Power supply input voltage	VDD	2.8	3.3	3.6	V	
I/O logic voltage	VDDIO	-	-	-	V	
Input voltage 'H' level	VIH	0.7VDDIO	-	VDDIO	V	
Input voltage 'L' level	VIL	VSS	-	0.3VDDIO	V	
Power supply current	IVDD	-	40	-	mA	
TFT gate on voltage	VGH	-	-	-	V	
TFT gate off voltage	VGL	-	-	-	V	
Analog power supply voltage	AVDD	-	-	-	V	
Differential input common mode voltage	Vcom	-	-	-	V	Note1

Note1 : The value is just the reference value. The customer can optimize the setting value by the different D-IC  
Vcom must be adjusted to optimize display quality, as Crosstalk and Contrast Ratio etc..

### 4. BACKLIGHT CHARACTERISTICS

#### (at Ta=25°C,RH=60%)

Item	Symbol	Min.	Typ.	Max.	Unit	Note
LED forward voltage	VF	16.8	18.0	19.2	V	IF=20*2mA
LED forward current	IF	-	40	-	mA	
LED power consumption	PLED	-	0.72	-	W	Note1
Number of LED	-		12		PCS	
Connection mode	-	6 in series 2 in parallel			/	
LED life-time	-	20000	-	-	Hrs	Note2

Note1 : Calculator value for reference : IF\*VF = PLED

Note2 : The LED life-time define as the estimated time to 50% degradation of initial brightness at Ta=25°C and IF =40mA. The LED lifetime could be decreased if operating IF is larger than 40mA.

# 5. EXTERNAL DIMENSIONS

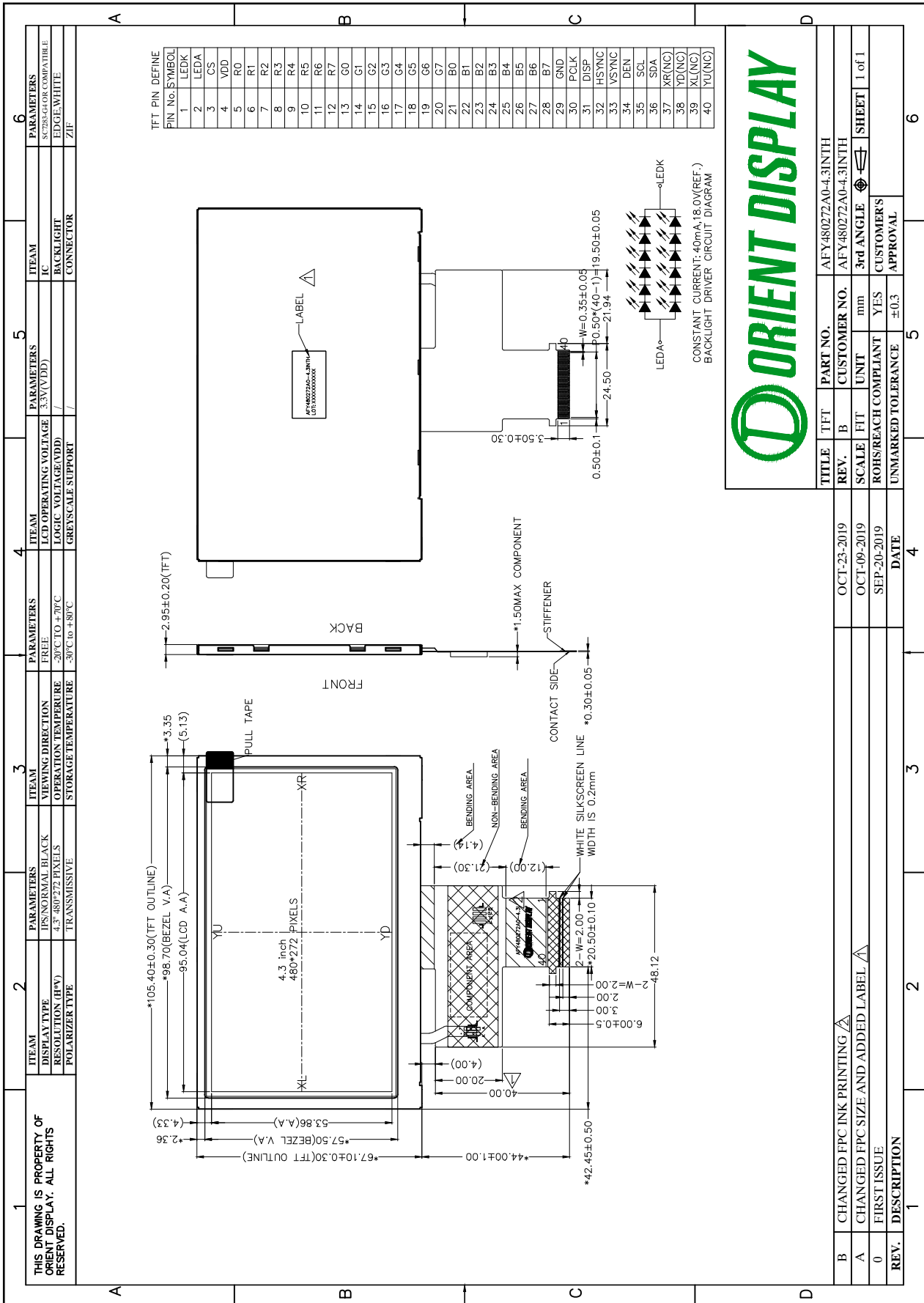

## 6. ELECTRO-OPTICAL CHARACTERISTICS

Item	Symbol	Condition	Min.	Typ.	Max.	Unit	Remark	Note
Response time	Tr+ Tf	-	-	30	40	ms	FIG.1	Note 1
Contrast ratio	Cr		640	800	-	-	FIG.2	Note 2
Surface luminance	Lv	$\theta=0^\circ$	800	1000	-	cd/m <sup>2</sup>	FIG.2	Note 3
Luminance uniformity	Yu	$\theta=0^\circ$	75	80	-	%	FIG.2	Note 4
NTSC	-	$\theta=0^\circ$	-	50	-	%	FIG.2	Note 5
Viewing angle	$\varnothing$	$\varnothing=90^\circ$	70	80	-	deg	FIG.3	Note 6
		$\varnothing=270^\circ$	70	80	-	deg	FIG.3	
		$\varnothing=0^\circ$	70	80	-	deg	FIG.3	
		$\varnothing=180^\circ$	70	80	-	deg	FIG.3	
CIE (x,y) chromaticity	Red x	$\theta=0^\circ$ $\varnothing=0^\circ$ Ta=25°C	Typ -0.04	0.61	Typ +0.04	-	FIG.2 CIE1931	Note 5
	Red y			0.36		-		
	Green x			0.37		-		
	Green y			0.57		-		
	Blue x			0.15		-		
	Blue y			0.11		-		
	White x			0.33		-		
	White y			0.35		-		

### Note1. Definition of response time

The response time is defined as the LCD optical switching time interval between “White” state and “Black” state. Rise time (T<sub>ON</sub>) is the time between photo detector output intensity changed from 90% to 10%. And fall time (T<sub>OFF</sub>) is the time between photo detector output intensity changed from 10% to 90%. For additional information see FIG1.

### Note2. Definition of contrast ratio

Contrast ratio(Cr) is defined mathematically by the following formula. For more information see FIG.2.

$$\text{Contrast ratio} = \frac{\text{Luminance measured when LCD on the "White" state}}{\text{Luminance measured when LCD on the "Black" state}}$$

Measured at the center area of the LCD

### Note3. Definition of surface luminance

Surface luminance is the luminance with all pixels displaying white. For more information see FIG.2.

$$L_v = \text{Average Surface Luminance with all white pixels}(P_1, P_2, P_3, \dots, P_n)$$

### Note4. Definition of luminance uniformity

The luminance uniformity in surface luminance is determined by measuring luminance at each test position 1 through n, and then dividing the maximum luminance of n points luminance by minimum luminance of n points luminance. For more information see FIG.2.

$$Y_u = \frac{\text{Minimum surface luminance with all white pixels } (P_1, P_2, P_3, \dots, P_n)}{\text{Maximum surface luminance with all white pixels } (P_1, P_2, P_3, \dots, P_n)}$$

### Note5. Definition of color chromaticity (CIE1931)

CIE (x,y) chromaticity, The x,y value is determined by screen active area center position P5. For more information see FIG.2.

### Note6. Definition of viewing angle

Viewing angle is the angle at which the contrast ratio is greater than 10. angles are determined for the horizontal or x axis and the vertical or y axis with respect to the z axis which is normal to the LCD surface. For more information see FIG.3.

For viewing angle and response time testing, the testing data is base on Autronic-Melchers's ConoScope or DMS series Instruments or compatible. For contrast ratio, Surface Luminance, Luminance uniformity and CIE, the testing data is base on TOPCON's BM-5or BM-7 photo detector or compatible.

**FIG.1. The definition of response Time**

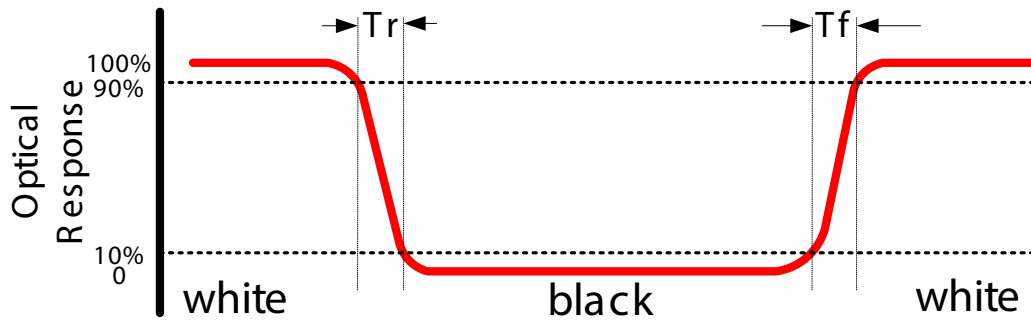

**FIG.2. Measuring method for contrast ratio, surface luminance, luminance uniformity, CIE (x,y) chromaticity**

H,V : Active area

Light spot size  $\square=5\text{mm}$ (BM-5) or  $\square=7.7\text{mm}$  (BM-7)50cm distance or compatible distance from the LCM surface to detector lens.

Test spot position : see Figure a.

measurement instrument : TOPCON's luminance meter BM-5 or BM-7 or compatible ,see Figure b.

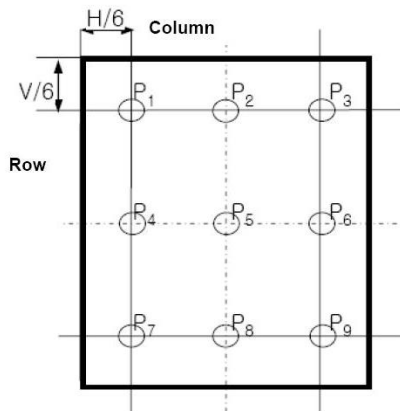

Figure a

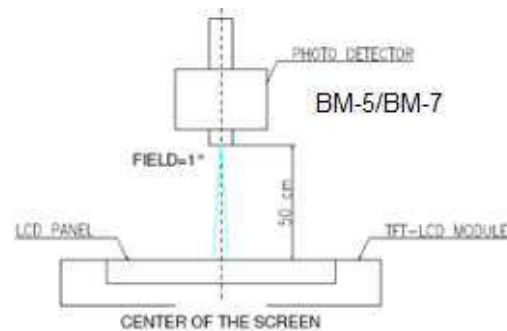
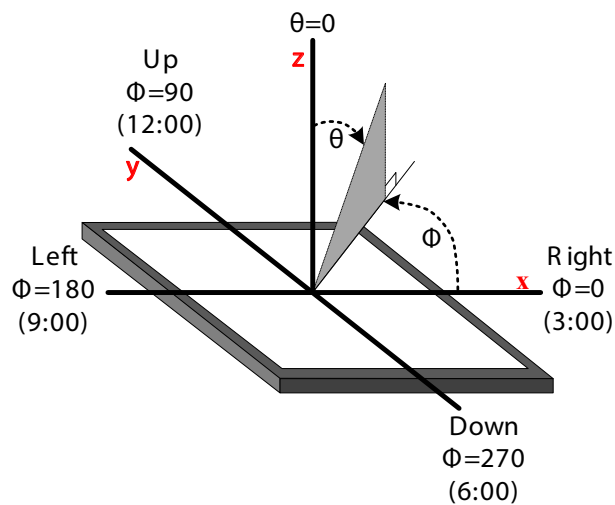

Figure b

**FIG.3. The definition of viewing angle**





## 7. INTERFACE DESCRIPTION

### Module Interface description

Interface No.	Name	I/O or connect to	Description
1	LEDK	P	Power for LED backlight(Cathode)
2	LEDA	P	Power for LED backlight(Anode)
3	CS	I	Chip Selected signal When CS=0,the chip is enable.
4	VDD	P	Power for LCD
5-12	R0-R7	I	Red data Bus
13-20	G0-G7	I	Green data Bus
21-28	B0-B7	I	Blue data Bus
29	GND	P	Ground
30	DCLK	I	Dot clock
31	DISP	I	Set display mode. DISP=0:Standby mode. DISP=1:Normal display mode.
32	HSYNC	I	Horizontal sync input.
33	VSYNC	I	Vertical sync input
34	DE	I	Data enable
35	SCL	I	Serial Clock input Signal
36	SDA	I/O	Serial Data input Signal
37	XR/NC	/	No Connection, the pin float
38	YD/NC	/	No Connection, the pin float
39	XL/NC	/	No Connection, the pin float
40	YU/NC	/	No Connection, the pin float

## 8. AC CHARACTERISTICS

AC Electrical Characteristics (PVDD=VDD=VDDI= 3.3V, AGND= 0V, TA=25°C, Bare Chip)

### 8.1 System Operation AC Characteristics

Item	Symbol	Min.	Typ.	Max.	Unit	Conditions
VDD Power Source Slew Time	TPOR	-	-	20	ms	From 0V to 99% VDD
GRB Pulse Width	tRSTW	10	50	-	us	R=10Kohm, C=1uF
SD Output Stable Time	Tst	-	-	12	us	Output settled within +20mV Loading = 6.8k+28.2pF.
GD Output Rise and Fall Time	Tgst	-	-	6	us	Output settled (5%~95%), Loading = 4.7k+29.8pF

### 8.2 System Bus Timing for SPI-3 Interface

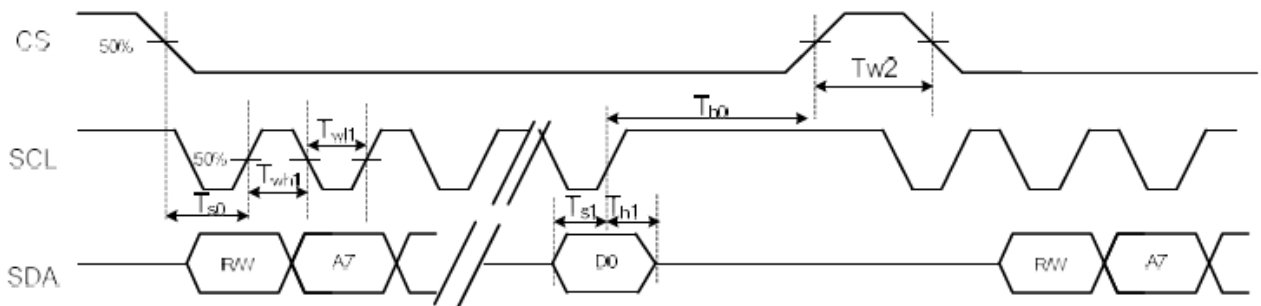

Item	Symbol	Min.	Typ.	Max.	Unit	Conditions
CS Input Setup Time	Ts0	50	-	-	ns	
Serial Data Input Setup Time	Ts1	50	-	-	ns	
CS Input Hold Time	Th0	50	-	-	ns	
Serial Data Input Hold Time	Th1	50	-	-	ns	
SCL Write Pulse High Width	Twh1	50	-	-	ns	
SCL Write Pulse Low Width	Twl1	50	-	-	ns	
SCL Read Pulse High Width	Trh1	300	-	-	ns	
SCL Read Pulse Low Width	Trl1	300	-	-	ns	
CS Pulse High Width	Tw2	400	-	-	ns	

### 8.3 System Bus Timing for RGB Interface

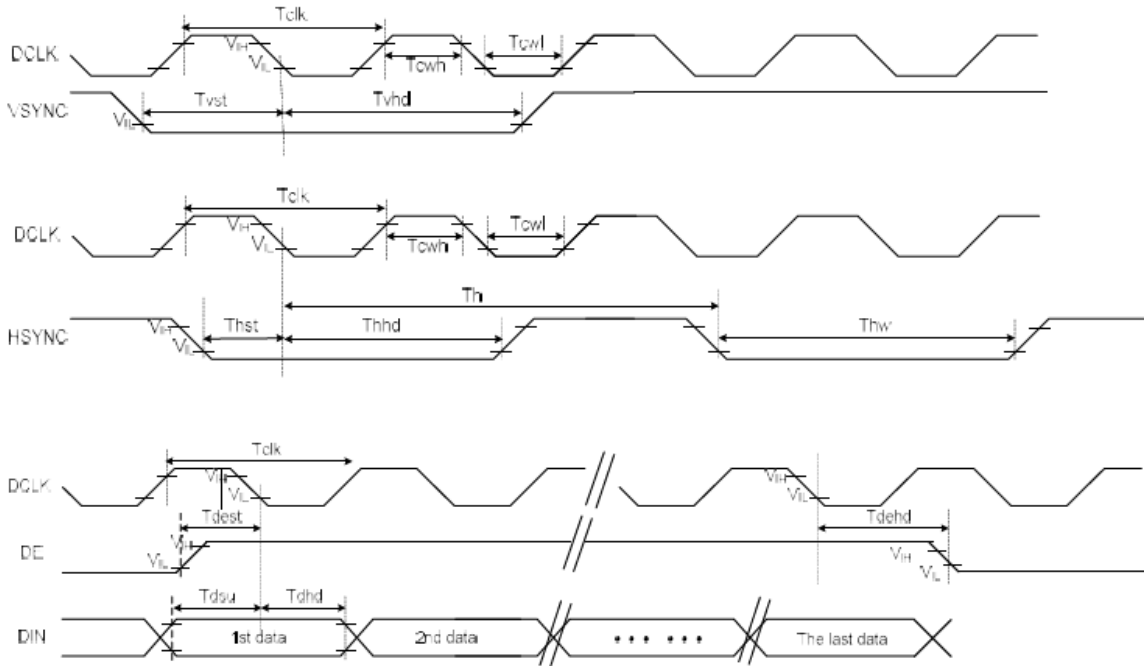

Item	Symbol	Min.	Typ.	Max.	Unit	Conditions
CLK Pulse Duty	$T_{cw}$	40	50	60	%	
HSYNC Width	$T_{hw}$	2	-	-	DCLK	
HSYNC Period	$T_h$	55	60	65	us	
VSYNC Setup Time	$T_{vst}$	12	-	-	ns	
VSYNC Hold Time	$T_{vhd}$	12	-	-	ns	
HSYNC Setup Time	$T_{hst}$	12	-	-	ns	
HSYNC Hold Time	$T_{hhd}$	12	-	-	ns	
Data Setup Time	$T_{dsu}$	12	-	-	ns	
Data Hold Time	$T_{dhd}$	12	-	-	ns	
DE Setup Time	$T_{dest}$	12	-	-	ns	
DE Hold Time	$T_{dehd}$	12	-	-	ns	

# 9. POWER SEQUENCE

## TFT Module POWER SEQUENCE

To prevent the device damage from latch up, the power ON/OFF sequence shown below must be followed.  
 Power ON: VDD, DGND→VDDA; Power OFF:AGND→VDD, DGND

In order to prevent SC7283-G4 from power ON reset fail, the rising time (tPOR) of the digital power supply VDD should be maintained within given specifications. The power ON/OFF timing sequence is illustrated as below:

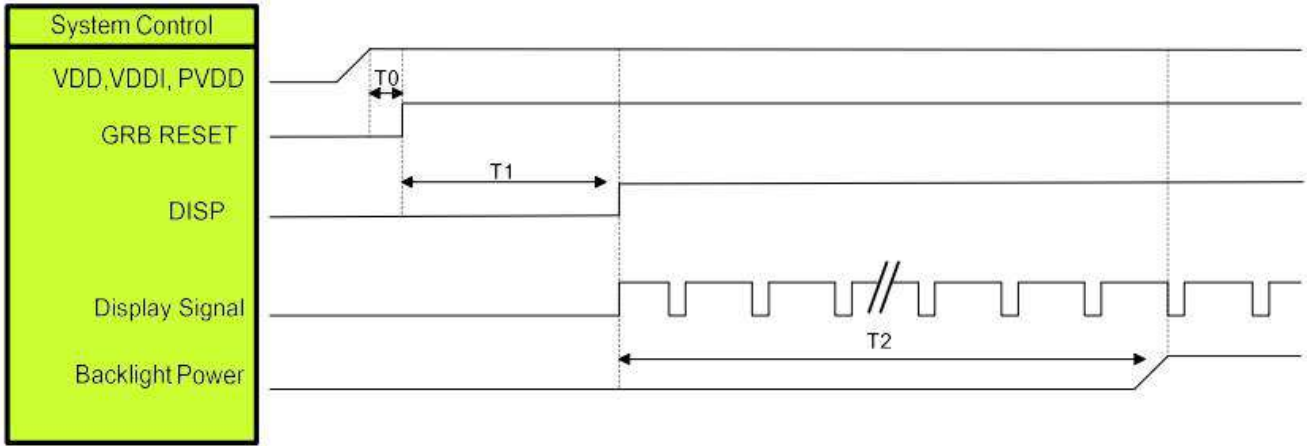

Symbol	Description	Min. Time	Unit
T0	System power stability to GRB RESET signal	0	ms
T1	GRB RESET= "High" to DISP="High"	10	ms
T2	Display Signal output to Backlight Power on	250	ms

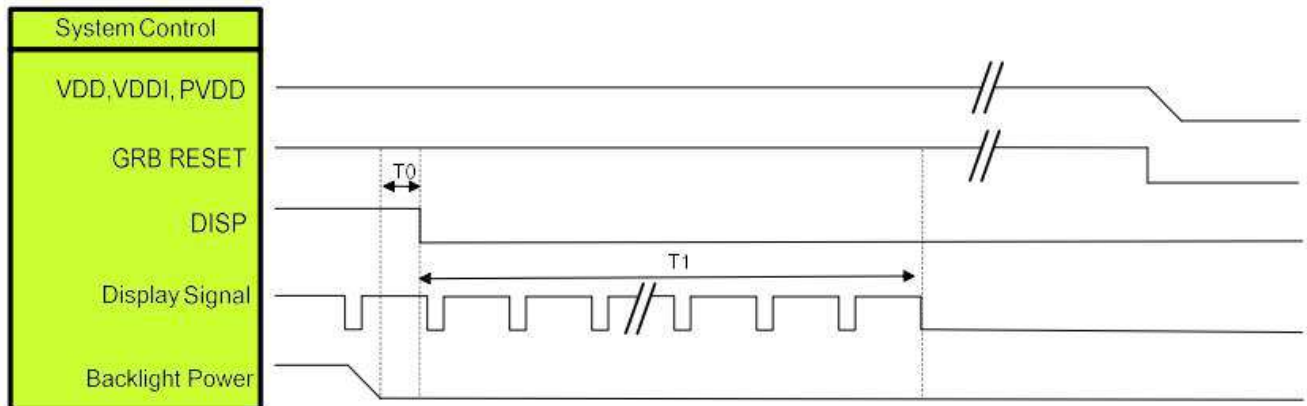

Symbol	Description	Min. Time	Unit
T0	Backlight Power off to DISP="Low"	5	ms
T1	DISP="Low" to IC internal voltage discharge complete	80	ms

## 10. RELIABILITY TEST CONDITIONS

No.	Test item	Test condition	Inspection after test	
10.1	High temperature storage test	+80°C/240 hours	Inspection after 2~4hours storage at room temperature, the sample shall be free from defects : 1.Current changing value before test and after test is 50% larger; 2. Function defect : Non-display,abnormal-d isplay,missing lines, Short lines,I TO corrosion; 3.Visual defect : Air bubble in the LCD,Seal leak,Glass crack.	
10.2	Low temperature storage test	-30°C/240 hours		
10.3	High temperature operating test	+70°C/120 hours		
10.4	Low temperature operating test	-20°C/120 hours		
10.5	Temperature cycle storage test	-30°C ~ 25°C ~ +80°C/10cycles (30min.) (10min.) (30min.)		
10.6	High temperature high humidity test	+50°C*90% RH/120 hours		
10.7	Vibration test	Frequency : 250 r/min Amplitude : 1 inch Time: 45min		
10.8	Drop test	Drop direction: 1 corner/3 edges/6 sides 10 time		
		Packing weight(kg)		Drop height(cm)
		<11		80±1.6
		11≤G<21	60±1.2	
		21≤G<31	50±1.0	
		31≤G<40	40±0.8	
10.9	ESD test	Air discharge: ±8KV, 10time Contact discharge: ±4KV, 10time		
Remark : 1.The test samples should be applied to only one test item. 2.Sample size for each test item is 3~5pcs. 3.For High temperature high humidity test, Pure water(Resistance>10MΩ) should be used. 4.In case of malfunction defect caused by ESD damage, if it would be recovered to normal state after resetting, it would be judged as a good part. 5.B/L evaluation should be excepted from reliability test with humidity and temperature: Some defects such as black spot/blemish can happen by natural chemical reaction with humidity and Fluorescence B/L has. 6.Failure judgment criterion: Basic specification, Electrical characteristic, Mechanical characteristic, Optical characteristic.				

## 11.INSPECTION CRITERION

Refer to the quality standard on the back of the specification

## 12. HANDLING PRECAUTIONS

### 12.1 Mounting method

The LCD module consists of two thin glass plates with polarizers which easily be damaged. And since the module is so constructed as to be fixed by utilizing fitting holes in the printed circuit board.

Extreme care should be needed when handling the LCD modules.

### 12.2 Caution of LCD handling and cleaning

When cleaning the display surface, Use soft cloth with solvent [recommended below] and wipe lightly :

- .Isopropyl alcohol
- .Ethyl alcohol

Do not wipe the display surface with dry or hard materials that will damage the polarizer surface.

Do not use the following solvent :

- .Water
- .Aromatics

Do not wipe ITO pad area with the dry or hard materials that will damage the ITO patterns

Do not use the following solvent on the pad or prevent it from being contaminated :

- .Soldering flux
- .Chlorine (Cl) , Sulfur (S)

If goods were sent without being silicon coated on the pad, ITO patterns could be damaged due to the corrosion as time goes on.

If ITO corrosion happens by miss-handling or using some materials such as Chlorine (Cl), Sulfur (S) from customer, Responsibility is on customer.

### 12.3 Caution against static charge

The LCD module uses C-MOS LSI drivers, so we recommend that you :

Connect any unused input terminal to Vdd or Vss, do not input any signals before power is turned on, and ground your body, work/assembly areas, assembly equipment to protect against static electricity.

### 12.4 Packing

Module employs LCD elements and must be treated as such.

- .Avoid intense shock and falls from a height.
- .To prevent modules from degradation, do not operate or store them exposed direct to sunshine or high temperature/humidity.

### 12.5 Caution for operation

- .It is an indispensable condition to drive LCD's within the specified voltage limit since the higher voltage than the limit causes the shorter LCD life.
- .An electrochemical reaction due to direct current causes LCD's undesirable deterioration, so that the use of direct current drive should be avoided.
- .Response time will be extremely delayed at lower temperature than the operating temperature range and on the other hand at higher temperature LCD's show dark color in them. However those phenomena do not mean malfunction or out of order with LCD's, which will come back in the specified operation temperature.
- .If the display area is pushed hard during operation, some font will be abnormally displayed but it resumes normal condition after turning off once.
- .A slight dew depositing on terminals is a cause for electro-chemical reaction resulting in terminal open circuit.
- .Usage under the maximum operating temperature, 50%Rh or less is required.
- .When fixed patterns are displayed for a long time, remnant image is likely to occur.

### 12.6 Storage

In the case of storing for a long period of time for instance, for years for the purpose or replacement use, the following ways are recommended.

- .Storing in an ambient temperature 10°C to 30°C, and in a relative humidity of 45% to 75%. Don't expose to sunlight or fluorescent light.
- .Storing in a polyethylene bag with the opening sealed so as not to enter fresh air outside in it . And with no desiccant.
- .Placing in a dark place where neither exposure to direct sunlight nor light's keeping the storage temperature range.
- .Storing with no touch on polarizer surface by anything else.

It is recommended to store them as they have been contained in the inner container at the time of delivery from us.

### **12.7 Safety**

- .It is recommendable to crash damaged or unnecessary LCD's into pieces and wash off liquid crystal by either of solvents such as acetone and ethanol, which should be burned up later.
- .When any liquid leaked out of a damaged glass cell comes in contact with your hands, please wash it off well with soap and water.

### **13. PRECAUTION FOR USE**

**13.1** A limit sample should be provided by the both parties on an occasion when the both parties agreed its necessity. Judgment by a limit sample shall take effect after the limit sample has been established and confirmed by the both parties.

**13.2** On the following occasions, the handing of problem should be decided through discussion and agreement between responsible of the both parties.

- .When a question is arisen in this specification.
- .When a new problem is arisen which is not specified in this specifications.
- .When an inspection specifications change or operating condition change in customer is reported to ODNA, and some problem is arisen in this specification due to the change.
- .When a new problem is arisen at the customer's operating set for sample evaluation in the customer site.

### **14. PACKING SPECIFICATION**

Please consult our technical department for detail information.

### **15. HSF COMPLIANCE**

- .This products complies with ROHS 2011/65/EU and 2015/863/EU、REACH 1907/2006/EC requirements, and the packaging complies with 94-62-EC.