

Applications

- Distributed power architectures
- Telecommunications equipment
- LAN/WAN
- Data processing

Description

The HLS Series of high density, single-output dc-dc converters, convert standard telecom and datacom voltages into isolated low-voltage outputs. High efficiencies and a unique copper-core printed circuit board design create superior thermal characteristics that enhance product reliability and eliminate the need for a heat sink.

Features

- RoHS lead solder exemption compliant
- Low profile, (-11mm) single-board design
- Input-to-output isolation: 1500 VDC, Basic insulation
- High efficiency - to 91% at full load
- Start-up into high capacitive load
- Low conducted and radiated EMI
- Output overcurrent protection
- Output overvoltage protection
- Overtemperature protection
- Remote sense
- Set point accuracy $\pm 1\%$
- Remote on/off (primary referenced), positive or negative logic
- Output voltage trim adjust, positive or negative
- UL1950 recognized, CSA 22.2 No. 950-95 certified, TUV IEC950

Model Selection						
Model	Input Voltage VDC	Input Current, Max ADC	Output Voltage VDC	Output rated current I_{rated} ADC	Output Ripple/Noise, mV p-p	Typical Efficiency @ I_{rated} %
HLS30ZG	36-75	4.8	5.0	30	100	91
HLS30ZE	36-75	3.3	3.3	30	100	89
HLS30ZD	36-75	2.5	2.5	30	100	88
HLS40ZB	36-75	3.0	1.8	40	100	88
HLS40ZA	36-75	2.5	1.5	40	100	87

This product is intended for integration into end-use equipment. All the required procedures for CE marking of end-use equipment should be followed.

 Model numbers highlighted in yellow or shaded are not recommended for new designs.

Absolute Maximum Ratings

Stresses in excess of the absolute maximum ratings may cause performance degradation, adversely effect long-term reliability, and cause permanent damage to the converter.

Parameter	Conditions/Description	Min	Max	Units
Input voltage	Continuous		75	VDC
	Transient, 100ms		100	VDC
Operating Temperature	Ambient	-40	100	°C
Storage Temperature		-40	125	°C
ON/OFF Control Voltage	Referenced to -Vin		50	VDC

Environmental, Mechanical & Reliability Specifications

All specifications apply over specified input voltage, output load, and temperature range, unless otherwise noted.

Parameter	Conditions/Description	Min	Nom	Max	Units
Maximum PCB Operating Temp.				100	°C
Operating Humidity	Relative humidity, non-condensing			95	%
Storage Humidity	Relative humidity, non-condensing			95	%
Shock	Halfsine wave, 6ms, 3 axes	50			g
Sinusoidal Vibration	GR-63-Core, Section 5.4.2	1			
Weight			1.4/40		Oz/g
Water Washing	Standard process		Yes		
MTBF (HLS30)	Per Bellcore TR-NWT-000332		1,780		kHrs
(HLS40)	Per Bellcore TR-NWT-000332		1,500		kHrs

Isolation Specifications

All specifications apply over specified input voltage, output load, and temperature range, unless otherwise noted.

Parameter	Conditions/Description	Min	Nom	Max	Units
Insulation Safety Rating		Basic			
Isolation Voltage	Input/Output	1500			VDC
Isolation Resistance	Input/Output	10			MΩ
Isolation Capacitance	Input/Output			1800	pF

Input Specifications

All specifications apply over specified input voltage, output load, and temperature range, unless otherwise noted.

Parameter	Conditions/Description	Min	Nom	Max	Units
Input Voltage	Continuous	36	48	75	VDC
Turn-On Input Voltage	Ramping Up	32	-	35	VDC
Turn-Off Input Voltage	Ramping Down	31	-	33	VDC
Turn-On Time	To Output Regulation Band 100% Resistive Load		5	10	ms
Input Reflected Ripple Current	Full Load, 12 μ H source inductance			80	mA p-p
Inrush Transient	Vin = Vin.max		0.1		A ² s

Output Specifications

All specifications apply over specified input voltage, output load, and temperature range, unless otherwise noted.

Parameter	Conditions/Description	Min	Nom	Max	Units
Output Voltage Setpoint Accuracy	Vin = Vin.nom, Full Load	-1		1	%Vout
Output Current *	HLS30	3		30	ADC
	HLS40	4		40	ADC
Line Regulation	Vin.min to Vin.max, Iout.max				
				0.25	%Vout
Load Regulation	Vin=Vnom, Iout.min to Iout.max			0.5	%Vout
				0.2	%Vout
Output Temperature Regulation	(Tboard temp) = -40°C to +100°C			0.5	%Vout
				0.03	%/°C
Remote Sense Headroom	Note: ***			10	%Vout
Dynamic Regulation Peak Deviation Settling Time	50-75% load step change to 1% error band			8	%Vout
				500	μ s
Admissible Load Capacitance	Iout.max, Nom Vin			30,000	μ F
Output Current Limit Threshold **	Vout \leq 0.97Vout.nom	110		140	%Iout
Switching Frequency	HLS30ZD		210		kHz
	HLS30ZG & HLS30ZE		300		kHz
	HLS40ZA & HLS40ZB		250		kHz
Overvoltage Protection, Non Latching (hiccup type)	Over all input voltage and load conditions	115		140	%Vout
Trim Range	Iout.max, Vin = Vnom	90		110	%Vout

* At Iout<Iout.min, the output may contain low frequency component that exceeds ripple specifications.

** Overcurrent protection is non-latching (hiccup type) with auto recovery.

*** Vout can be increased up to 10% via the sense leads or up to 10% via the trim function, however total output voltage trim from all sources should not exceed 10% of Vout



HLS Series DC-DC Converter Data Sheet 48 VDC Input, 30 & 40 Amp Half-Bricks

Feature Specifications

All specifications apply over specified input voltage, output load, and temperature range, unless otherwise noted.

Parameter	Conditions/Description	Min	Nom	Max	Units
On/Off					
Negative Logic (-N suffix) On/Off (pin #3) (Primary side ref. to -Vin)	(On/Off signal is low – converter is ON)				
	Converter ON Sink current	-1.0		1.8 1	VDC mADC
	Converter OFF Open circuit voltage	3.5	2	50	VDC VDC
Positive Logic (-P suffix) On/Off (pin #3) (Primary side ref. to -Vin)	(On/Off signal is low – converter is OFF)				
	Converter ON Open Circuit Voltage	3.5	3	50	VDC VDC
	Converter OFF Sink Current	-1.0		1.8 1	VDC mADC
Over Temperature Protection					
Type	Non-latching, auto-recovery				
Threshold	Average PCB temperature	100		120	°C
Auto recovery			90		°C

Characteristic Curves:

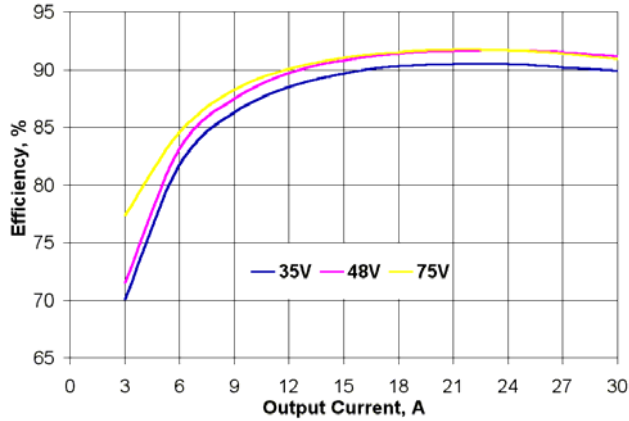

Figure 1. HLS30ZG (5V) Efficiency vs. Output Load

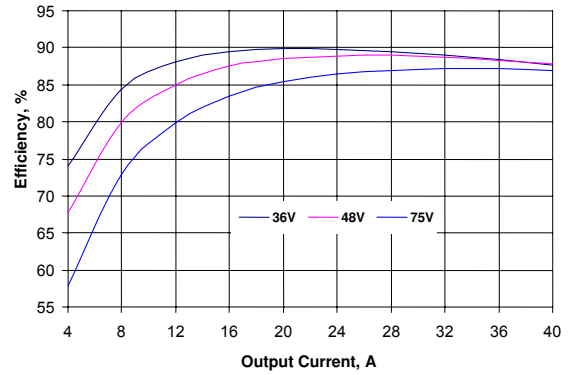

Figure 4. HLS40ZA (1.5V) Efficiency vs. Output Load

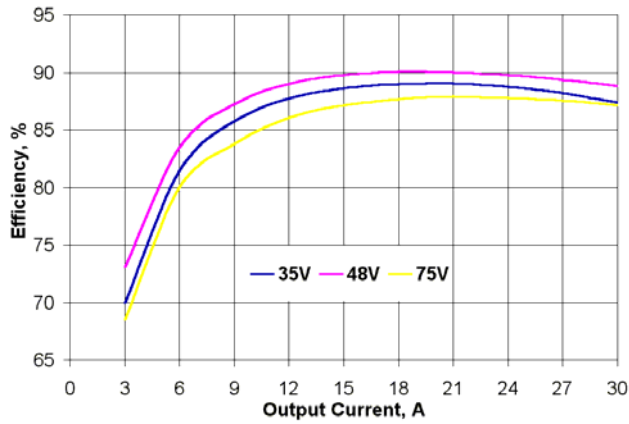

Figure 2. HLS30ZE (3.3V) Efficiency vs. Output Load

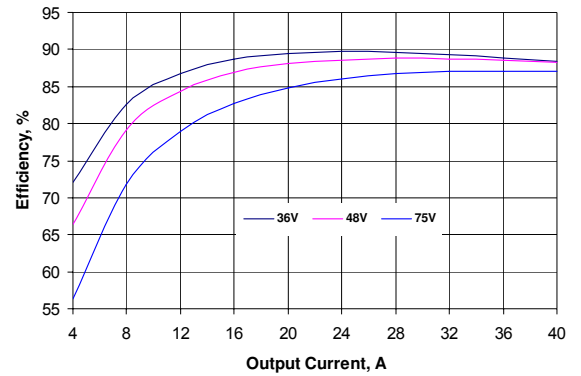

Figure 5. HLS40ZB (1.8V) Efficiency vs. Output Load

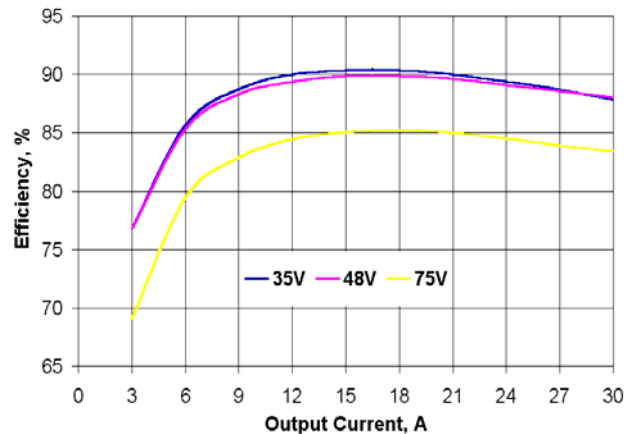

Figure 3. HLS30ZD (2.5V) Efficiency vs. Output Load

Typical Application

Figure 6 shows the recommended connections for the HLS Series converter.

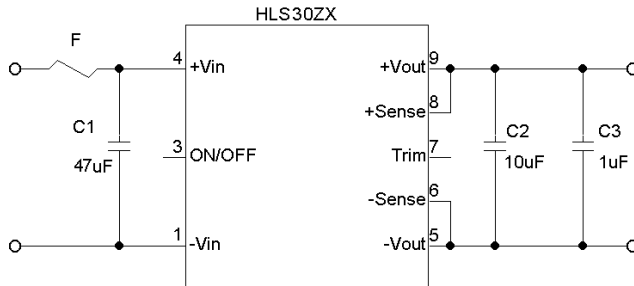

Figure 6. Typical Application of HLS Series

The HLS Series converters do not require any external components for proper operation. However, if the distribution of the input voltage to the converter contains significant inductance, the capacitor C1 may be required to enhance performance of the converter. A minimum of a 47 µF electrolytic capacitor with the ESR<0.7Ω is recommended for the HLS Series.

Refer to the “Inrush Current Control Application Note” on www.power-one.com for suggestions on how to limit the magnitude of the inrush current.

For output decoupling we recommend using one 10µF tantalum and one 1 µF ceramic capacitors connected directly across the output pins of the converter. Note, that the capacitors do not substitute the filtering required by the load.

Shutdown Feature Description

The ON/OFF pin in the HLS Series converters functions as a normal soft shutdown. It is referenced to the -Vin pin (see Figure 6). With **positive logic**, when the ON/OFF pin is pulled low, the output is turned off and the unit goes into a very low input power mode. With **negative logic**, when the ON/OFF pin is pulled low, the unit is turned on.

An open collector switch is recommended to control the voltage between the ON/OFF pin and the -Vin pin of the converter. The ON/OFF pin is pulled up internally, so no external voltage source is required. The user should avoid connecting a resistor between the ON/OFF pin and the +Vin pin.

When the ON/OFF pin is used to achieve remote control, the user must take care to insure that the pin reference for the control is really the -Vin pin. The control signal must not be referenced ahead of EMI filtering or remotely from the unit. Optically coupling the information and locating the optical coupler directly at the module will solve any of these problems.

Note:

If the ON/OFF pin is not used, it can be left floating (positive logic), or connected to the -Vin pin (negative logic).

Output Voltage Trim

The trim feature allows the user to adjust the output voltage from the nominal value. This can be used to compensate distribution drops, perform margining in production, or accommodate other requirements when output voltage needs to be adjusted from the nominal. There are two trim options available in the HLS Series.

Negative-Trim (No P/N suffix)

All HLS negative-trim models trim up with a resistor connected from the TRIM pin to the (-) Sense pin and trim down with a resistor from the TRIM pin to the (+) Sense pin as shown in Figure 7.

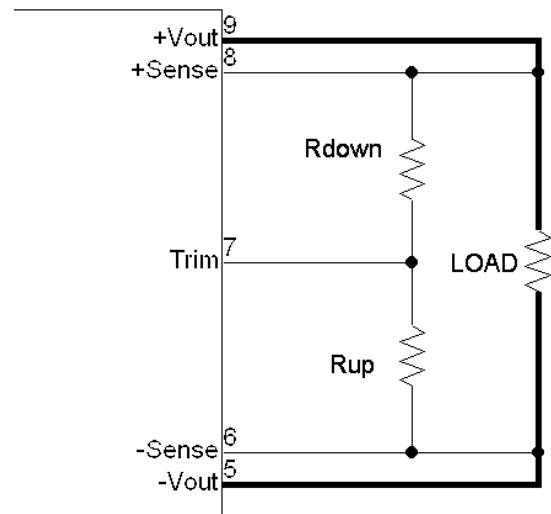

Figure 7. HLS Series Negative Trim Schematic

The general equation (1) for changing the output voltage on the standard trim modules is invariant, but the constants in the equation change due to different internal design.

$$R_{TRIM} = \frac{A - B \times \Delta V}{\Delta V}, \text{ k}\Omega \quad (1)$$

Where A and B are constants from the table below, and ΔV is the absolute value of the desired change in the output voltage in Volts.

Model	Trim Up		Trim Down	
	A	B	A	B
HLS30ZG	3.77	6.81	11.58	9.88
HLS30ZE	2.07	3.92	3.5	5.61
HLS30ZD	1.27	3.92	1.31	4.95
HLS40ZA	See below	n/a	See below	n/a
HLS40ZB	See below	n/a	See below	n/a

Negative-Trim, HLS40 models (No P/N suffix)

If an external resistor is placed between the Trim pin and (+) Sense pin, the output voltage decreases. The equation determines the required external resistor value to obtain an output voltage change of $\Delta\%*$.

$$R_{trim-dn} = R1 * \left(\frac{Vo * (100 - \Delta\%) - 122.5}{Vo * \Delta\%} \right) - R2 \text{ k}\Omega$$

If an external resistor is used between Trim pin and (-) Sense pin, the output voltage increases. The equation determines the required external resistor value to obtain an output voltage change of $\Delta\%*$.

$$R_{trim-up} = \left(\frac{122.5 * R1}{Vo * \Delta\%} - R2 \right) \text{ k}\Omega$$

Where R1 and R2 are constants from the table below

Model	R1 (k Ω)	R2 (k Ω)
HLS30ZG	3.077	6.81
HLS30ZE	1.690	3.92
HLS30ZD	1.039	3.92
HLS40ZA	0.223	0.15
HLS40ZB	0.475	1

* NOTE: $\Delta\%$ - Percentage output voltage trim down or up.

Optional Positive Trim all models (-T, P/N suffix)

The -T option units trim up with a resistor from the TRIM pin to the (+) Sense pin and trim down with a resistor from the TRIM pin to the (-) Sense pin as shown in the Figure 8.

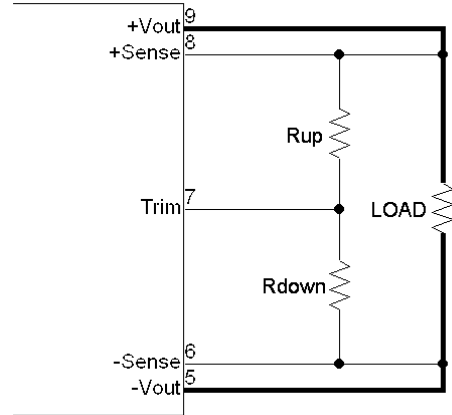

Figure 8. HLS Series Positive Trim Schematic

The equations below determine the trim resistor value required to achieve a ΔV change in the output voltage.

$$R_{UP} = \frac{Vout \times (100 + \Delta V\%) - 100 + 2 \times \Delta V\%}{1.225 \times \Delta V\%}, \text{ k}\Omega$$

$$R_{DOWN} = \frac{100}{\Delta V\%} - 2, \text{ k}\Omega$$

where $\Delta V\%$ is the output voltage change expressed in percents of the nominal output voltage, Vout.

NOTES:

1. When the output voltage is trimmed up, the output power from the converter must not exceed its maximum rating. This is determined by measuring the output voltage on the output pins, and multiplying it by the output current.
2. In order to avoid creating apparent load regulation degradation, it is important that the trim resistors are connected directly to the remote sense pins, and not to the load or to traces going to the load.
3. The HLS Series converters will trim down further than the 10% limit. In general, this is permissible. The user must confirm that the results are acceptable in his application.

Safety Considerations

The HLS Series converters feature 1500 Volt DC isolation from input to output. The input to output DC resistance is greater than 10MΩ. These converters are provided with Basic insulation between input and output circuits according to all IEC60950 based standards. Nevertheless, if the system using the converter needs to receive safety agency approval, certain rules must be followed in the design of the system. In particular, all of the creepage and clearance requirements of the end-use safety requirements must be observed. These documents include UL60950, CSA60950-00 and EN60950, although other additional requirements may be needed for user's specific applications.

The HLS Series converters have no internal fuse. An external fuse must be provided to protect the system from catastrophic failure, as illustrated in Figure 6. The fuse with a rating not greater than 10 A is recommended. The user can select a lower rating fuse based upon the highest inrush transient at the maximum input voltage and the maximum input current of the converter at the minimum input voltage. Both input traces and the chassis ground trace (if applicable) must be capable of conducting a current of 1.5 times the value of the fuse without opening. The fuse must not be placed in the grounded input line, if any.

In order for the output of the HLS Series converter to be considered as SELV (Safety Extra Low Voltage) or TNV-1, according to all IEC60950 based standards, one of the following requirements must be met in the system design:

- If the voltage source feeding the module is SELV or TNV-2, the output of the converter may be grounded or ungrounded.
- If the voltage source feeding the module is ELV, the output of the converter may be considered SELV only if the output is grounded per the requirements of the standard.
- If the voltage source feeding the module is a Hazardous Voltage Secondary Circuit, the voltage source feeding the module must be provided with at least Basic insulation between the source to the converter and any hazardous voltages. The entire system, including the HLS converter, must pass a dielectric withstand test

for Reinforced insulation. Design of this type of system requires expert engineering and understanding of the overall safety requirements and should be performed by qualified personnel.

Thermal Considerations

The HLS Series converters are designed for natural or forced convection cooling. The maximum allowable output power of the converters is determined by meeting the derating criteria of all electronic components used in the power supplies. An example of the derating criteria for the semiconductor junction temperature is not to exceed 120 °C to provide reliable, long-term operation of the converters.

The graphs in Figures 10-14 show the maximum output current of the HLS Series converters at different ambient temperatures under both natural and forced (longitudinal airflow direction, from pin 1 to pin 4) convection. This is further illustrated in Fig. 9 as arrow 'A'. As an example, from Figure 10, the HLS30ZG operating at 55 °C can deliver up to 22 A reliably with 100 LFM forced air, while up to 25 A reliably with 200 LFM forced air.

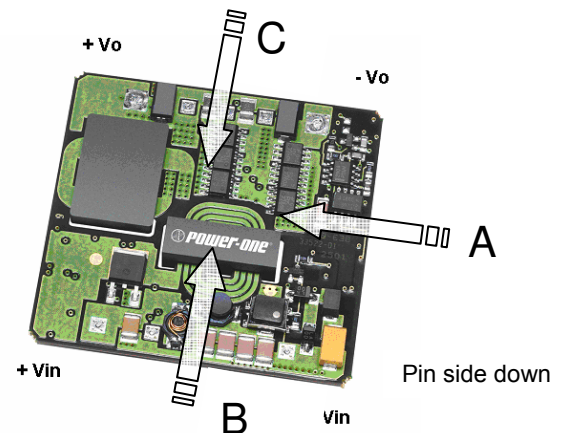

Figure 9. HLS Forced Airflow Directions (A, B, C)

Airflow directions 'A' and 'C' should be considered equivalent in terms of the cooling effectiveness each provides. Direction 'B' can offer a marginal ($\leq 3.5\%$) power capability improvement over that offered by 'A' or 'C'. This characteristic is demonstrated in Fig. 15.

Note:

Figure 15 was established with $V_{in} = 48$ VDC, and figures 10-14 at $V_{in} = 52$ VDC. The resulting small difference in converter efficiency introduces an error term that prevents accurate correlation directly between figures 10 and 15.)

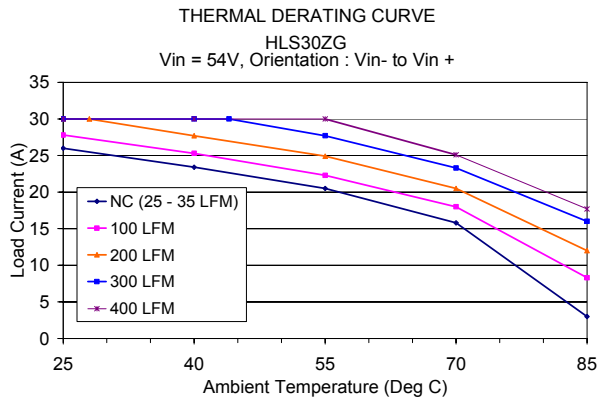

Figure 10. HLS30ZG (5V) Derating Curves

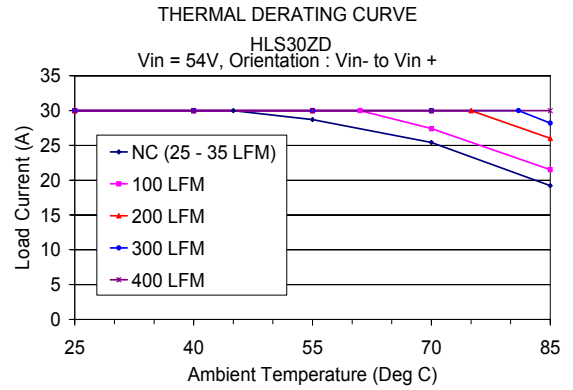

Figure 13. HLS40ZB (1.8V) Derating Curves

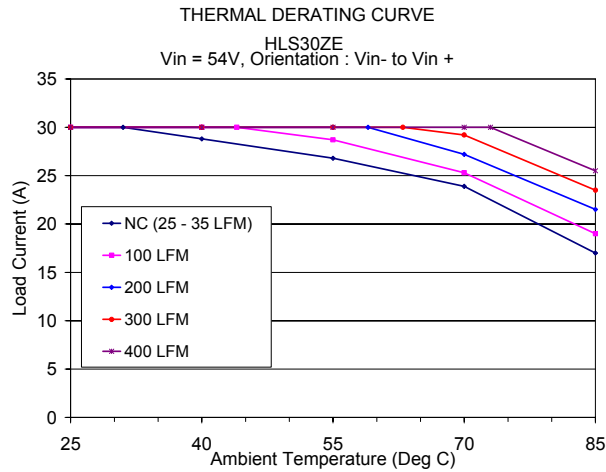

Figure 11. HLS30ZE (3.3V) Derating Curves

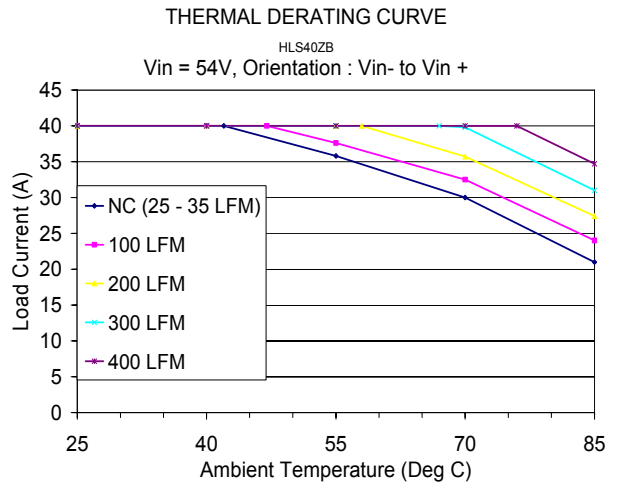

Figure 14. HLS30ZD (2.5V) Derating Curves

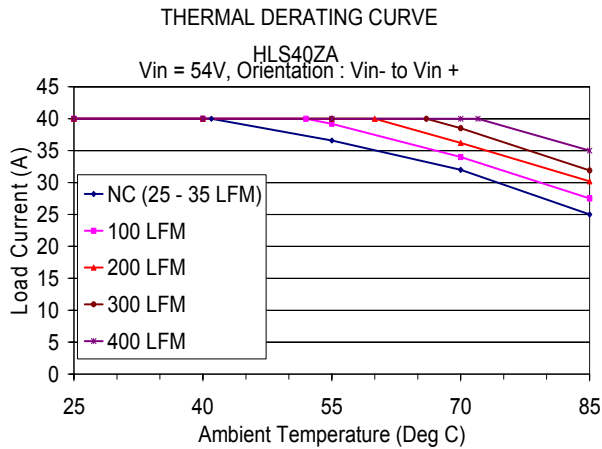

Figure 12. HLS40ZA (1.5V) Derating Curves

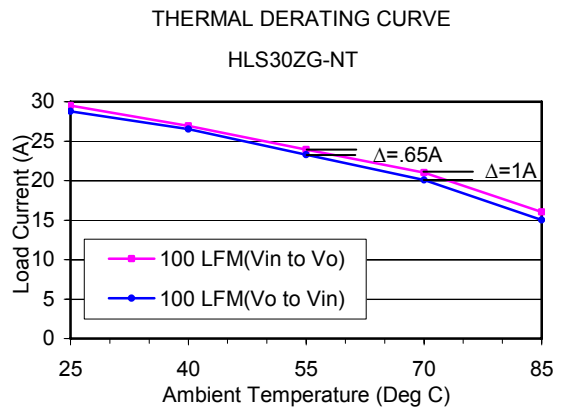
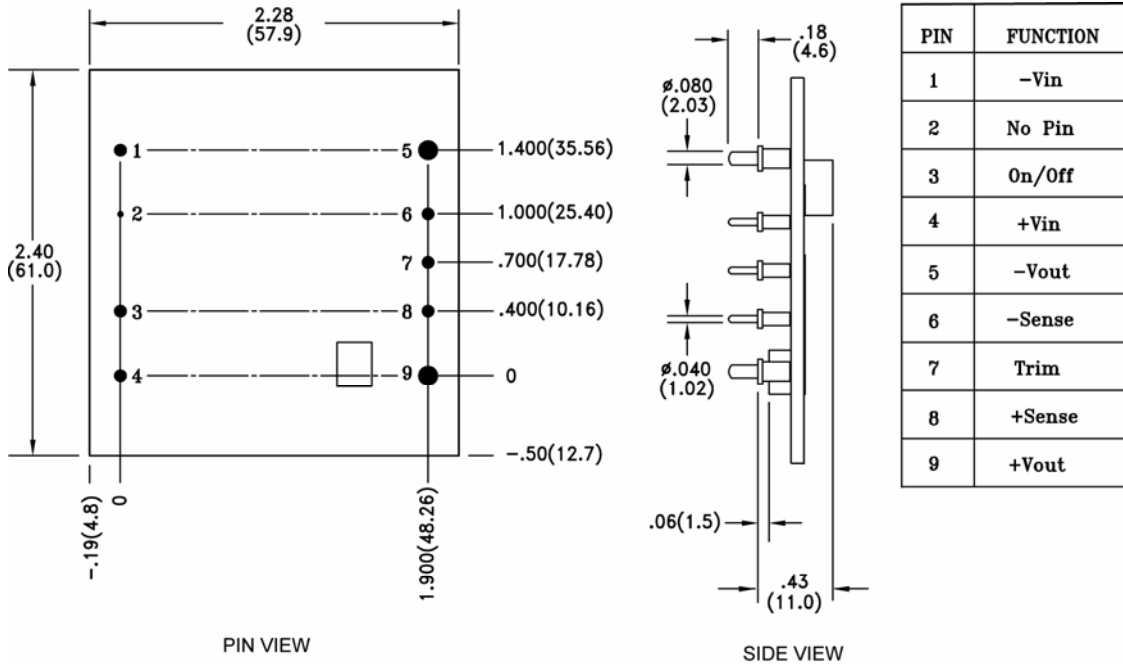

Figure 15. Effect of Airflow Direction on Power Rating [HLS30ZG (5V) shown]

Mechanical Drawing



TOLERANCES: .XX ± 0.020 (.5)
.XXX ± 0.010 (.25)
PIN DIAMETER: ± 0.002 (.05)

Ordering Information

Options	Suffixes to add to part number
Remote ON/OFF	Positive- no suffix required
	Negative- Add "N" suffix
Trim	Negative- no suffix required
	Positive - Add "T" suffix
Pin Length	0.18"- no suffix required
	0.11"- Add "8" suffix
	0.145"- Add "7" suffix

NOTES:

1. Consult factory for the complete list of available options.

NUCLEAR AND MEDICAL APPLICATIONS - Power-One products are not designed, intended for use in, or authorized for use as critical components in life support systems, equipment used in hazardous environments, or nuclear control systems without the express written consent of the respective divisional president of Power-One, Inc.

TECHNICAL REVISIONS - The appearance of products, including safety agency certifications pictured on labels, may change depending on the date manufactured. Specifications are subject to change without notice.