

ABU125-480

Description:

The ABU125-480 is a single output power supply. This power supply is designed for a wide variety applications where high reliability is desired, including applications for the industrial and telecommunications markets. Excellent performance specifications are provided, together with compliance to European EMC (EN55022, Class B and EN61000-3-2), and Low Voltage directive.

Specifications (@25C)

Input Characteristics:

Input Voltage:	90-264VAC, 127-373VDC
Input Frequency Range:	47-63Hz
Input Current:	1.6A @ 115VAC, 0.8A @ 230VAC typ.
Max Inrush Current:	30A@115VAC, 60A@230VAC at cold start
Power Factor:	>0.95/230VAC, >0.98/115VAC at full load
Leakage Current:	<2.4mA/240Vac

Output Characteristics:

Output Voltage:	48VDC±2.0%Vdc
Output Current (Convection):	0-2.09A
Output Power (Convection):	100W
Adjustable Output Range:	45.6 – 50.4V. Output voltage can be adjusted at VR51
Ripple & Noise¹:	240mVp-p
Load Regulation:	±1.0%
Line Regulation:	±0.5%
Efficiency:	88.0%
Start-up Time:	1500ms/230VAC, 3000ms/115VAC, full load
Rise-up Time:	30ms/230VAC, 30ms/115VAC, full load
Hold-up Time:	14ms/230VAC, 14ms/115VAC, full load
Over Current Protection:	2.86 – 3.9A. Hiccup mode. Resets automatically once the fault condition is removed.
Over Voltage Protection:	55.2 – 64.8VDC.

General Specifications:

Dimension (LxWxH):	127(5.0) x 76.2(3.0) x 27.0(1.05) mm (in)
Weight:	300g
Cooling:	Natural Convection or FAN at 15CFM
Isolation Resistance:	I/P—O/P, I/P—FG, O/P—FG: 500VDC/100M Ohms
Dielectric Strength:	I/P—O/P:3KVAC; I/P—FG:1.5KVAC; O/P—FG:0.5KVAC
Warranty:	3 years
MTBF:	200K hrs. min. MIL-HDBK-217F (25°C)

Environmental Specifications:

Operating Temperature:	-20° to 50°C at full load (Refer to output load derating curve)
Operating Humidity:	20 to 90% RH, non-condensing
Storage Temperature:	-40 to 85°C
Storage Humidity:	10 to 95% RH, non-condensing
Temperature Drift:	<0.04%/°C (0-50°C)
Vibration:	10-500Hz, 2G 10min/cycle, period of 60min, each X, Y & Z axis

EMC & Safety Specifications²:

EMI Emissions:	Compliance to EN55022, CISPR22 Class B (Conducted & Radiated)
Harmonic Current:	Compliance to EN61000-3-2, 3
EMS Immunity:	Compliance to EN61000-4-2, 3-6, 8 & 11; EN55024 heavy, light industry level, criteria A
Safety Approval:	UL 60950-1, (insulation class -1)



¹ Ripple and noise are measured at 20MHz of bandwidth by using a 12" twisted-pair wire termination with a 0.1uF & 47uF parallel capacitors.

² The power supply is considered a component which will be installed into a final equipment. The final equipment must be re-confirmed that it still meets EMC directives.

Outline Dimensions (mm):

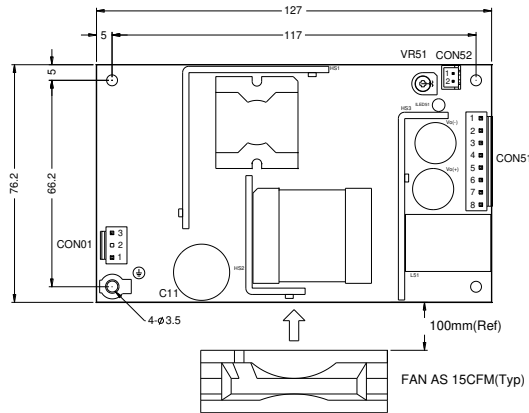

NOTE :

- All I/O connection shall Follow specified Model Label.
- Temp = +50°C (max) at full load.

Connections:

AC Input Connector (CON1)
JST B3P-VH or equivalent

Assignment	Assignment
P1	AC/N
P	(N.C.)
P3	AC/L

DC Output Connector (CON51)
JST B8P-VH or equivalent

Assignment	Assignment
P1~P4	COM
P5~P8	V+

DC Output Connector (ON52-Optional)
JST B2B-XH

Assignment	Assignment
P1	Vs+
P2	Vs-

Block Diagram:

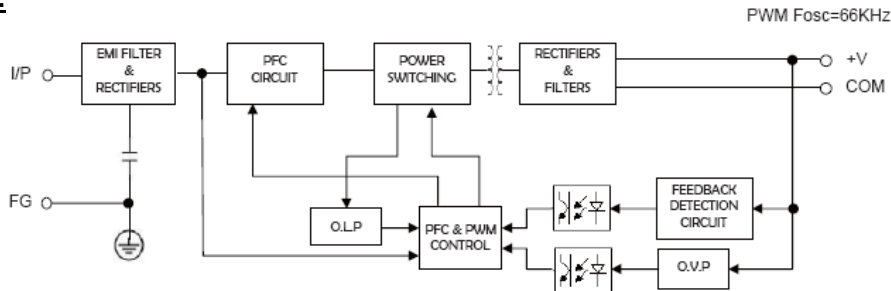

Derating Curve:

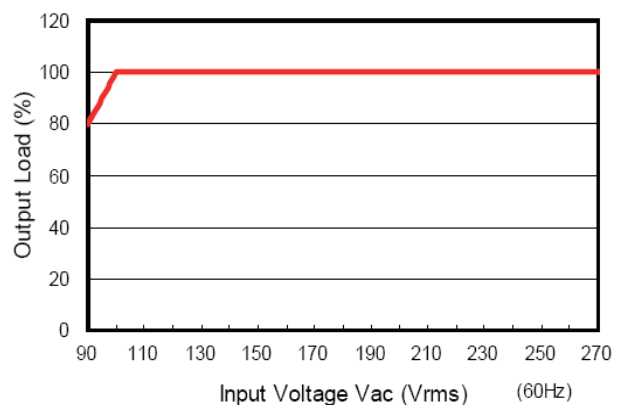
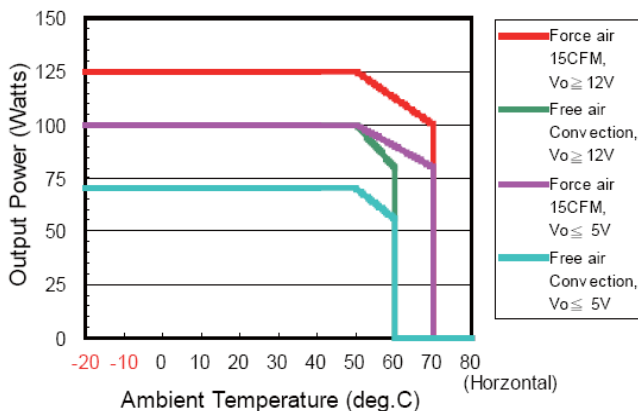

RoHS Compliance: As of manufacturing date February 2016, all standard products meet the requirements of 2015/863/EU, known as the RoHS 3 initiative.

* Upon printing, this document is considered "uncontrolled". Please contact Triad Magnetics' website for the most current version.