

ISL8115EVAL1Z

Synchronous Buck Converter

AN1881

Rev 1.00

September 25, 2013

Introduction

The ISL8115EVAL1Z is a Synchronous Buck Converter implementing Intersil's wide input range PWM controller ISL8115. Utilizing voltage mode control with input feed-forward, the ISL8115EVAL1Z maintains a constant loop gain for optimal transient response, especially for applications with a wide input voltage range. For a more detailed description of the ISL8115 functionality, refer to the [ISL8115](#) data sheet.

This application note includes the test setup, typical performance waveforms, schematic, layout and Bill of Materials (BOM).

Evaluation Board Specifications

TABLE 1. EVALUATION BOARD ELECTRICAL SPECIFICATIONS

SPEC	DESCRIPTION	MIN	TYP	MAX	UNIT
V _{IN}	Board Input Range	10	12	15	V
V _{OUT}	Output Voltage		1.5		V
I _{OUT}	Output Rated Current		30		A
I _{OC}	Overcurrent Threshold		32		A
F _{SW}	Switch Frequency		220		kHz
Input UVP	Rising threshold		9.7		V
	Falling threshold		9.2		V
η	Efficiency at 50% load		90.88		%



FIGURE 1. ISL8115EVAL1Z EVALUATION BOARD

ISL8115 Key Features

- Wide V_{IN} range operation: 2.97V to 36V; up to 5.5V output and 30A load current per phase.
- Fast transient response
 - Voltage-mode PWM leading-edge modulation with non-linear control
 - Input voltage feed-forward
- Integrated 5V high speed 4A MOSFET gate drivers
 - Internal bootstrap diode
- Oscillator programmable from 150kHz to 1.5MHz
 - Frequency synchronization to external clock signal
- Diode emulation mode for light load efficiency improvement
- Output OVP/UVP; OCP and OTP
- Power-good open drain output
- Adjustable soft-start
- Pre-bias start-up function
- Excellent output voltage regulation
 - 0.6V ±1.0% internal reference (-40°C~125°C)
 - 0.6V ±0.7% internal reference (-40°C~105°C)
 - Differential voltage sensing

Applications

- Power supply for datacom/telecom and POL
- Wide input voltage range buck regulators
- High current density power supplies RF power amplifier bias compensation

Recommended Equipment

- Input power source up to 15V supply voltage with 60W power supply ability
- Electronic load with 50W power sinking ability
- Voltmeters and ammeters
- 100MHz quad-trace oscilloscope

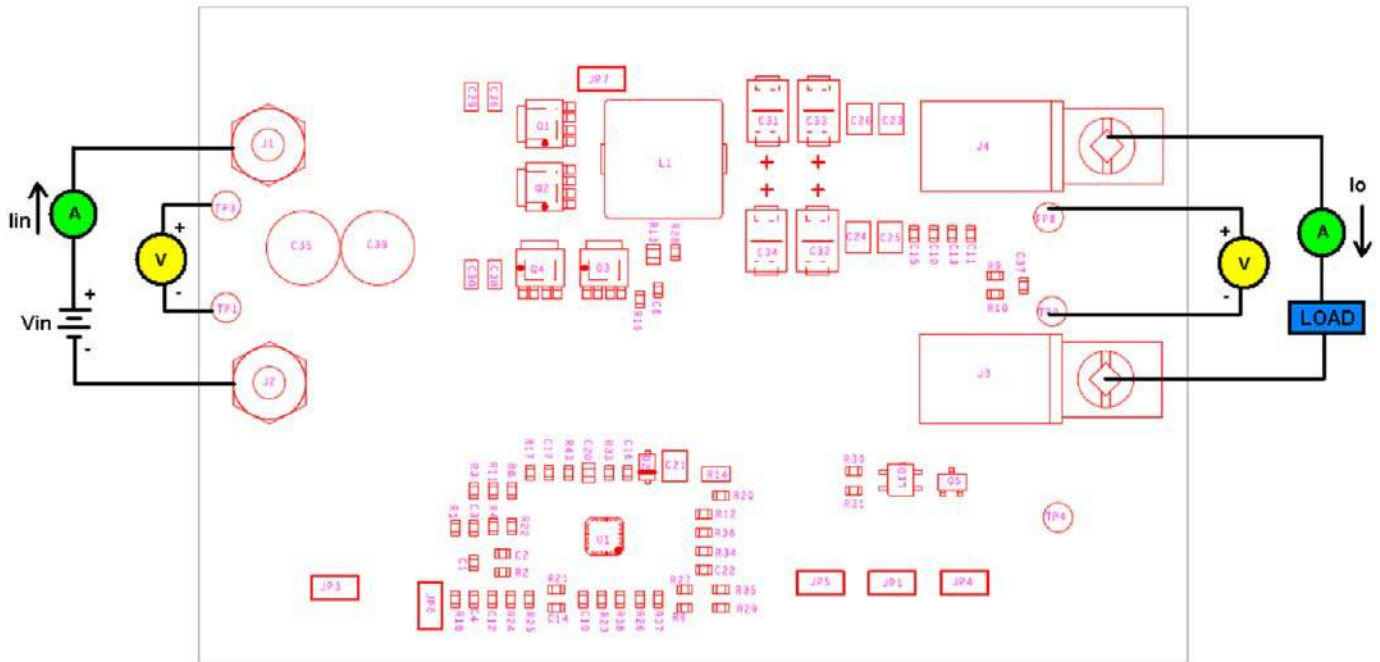

FIGURE 2. ISL8115EVAL1Z TEST SET-UP

Quick Test Setup

1. Ensure that the Evaluation board is correctly connected to the power supply and the electronic load prior to applying any power. Please refer to Figure 2 for proper set-up.
2. Set the input voltage to 12V, turn on the power supply and observe output voltage. The output voltage should variation should be within 5%.
3. Adjust load current within 30A. The output voltage variation should be within 5%.
4. Use oscilloscope to observe output ripple voltage and phase node ringing. For accurate measurement, please refer to Figure 3 for proper set-up.

Note: Test points TP1; TP3; TP8; TP9 are for voltage measurement only. Do not allow high current through these test points.

Probe Set-up

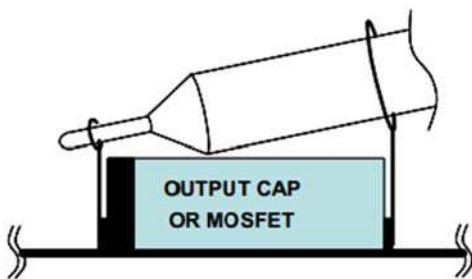

FIGURE 3. OSCILLOSCOPE PROBE SET-UP

Design Guide

The ISL8115EVAL1Z is optimized for 10V to 15V input voltage range. However, the evaluation board can be modified to support multiple applications due to the customer requirements. Please refer to the datasheet for the detailed information.

Output Voltage Adjustment

The output voltage can be set by the resistor R4, R1. In order to keep the existing compensation parameters unchanged, adjust R4 to set the output voltage by the following Equation 1:

$$R4 = \frac{0.6V \times R1}{Vout - 0.6V} \tag{EQ. 1}$$

VMON monitors the output for UVP and OVP, the resistor divider value of R11/R8 should be the same with the R1/R4.

Synchronization

ISL8115EVAL1Z board can be synchronized with an external clock. Apply a clock signal (10% to 90% duty cycle) in the range of 150kHz to 1.5MHz to the FSET pin makes the internal frequency synchronized with the external clock. Please remove R27 when the sync function is implemented.

Typical Performance Curves Unless otherwise specified, the input voltage is 12V.

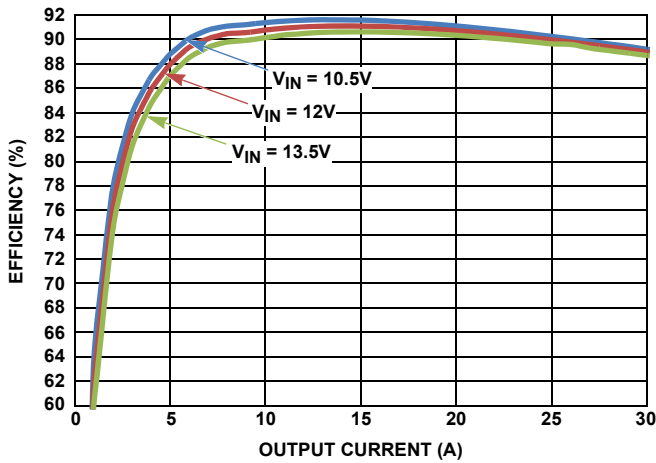

FIGURE 4. EFFICIENCY vs LOAD CURRENT AT CCM MODE

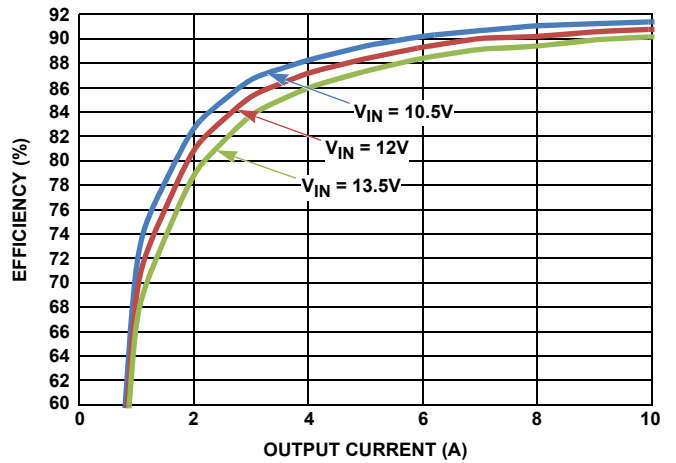

FIGURE 5. EFFICIENCY vs LOAD CURRENT AT DEM MODE

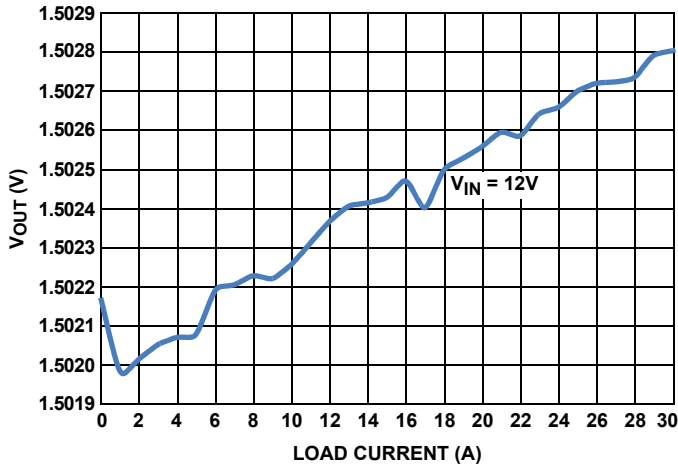

FIGURE 6. V_{OUT} LOAD REGULATION AT CCM MODE

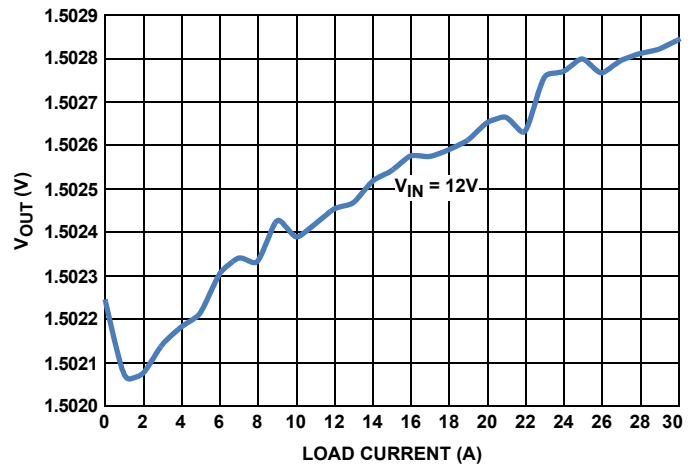

FIGURE 7. V_{OUT} LOAD REGULATION AT DEM MODE

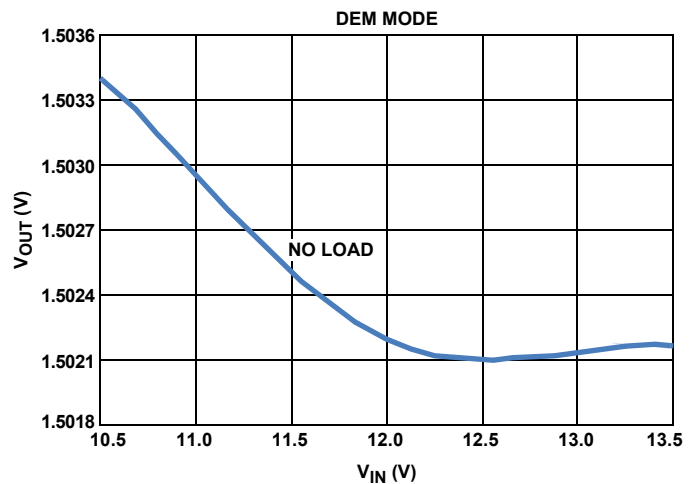
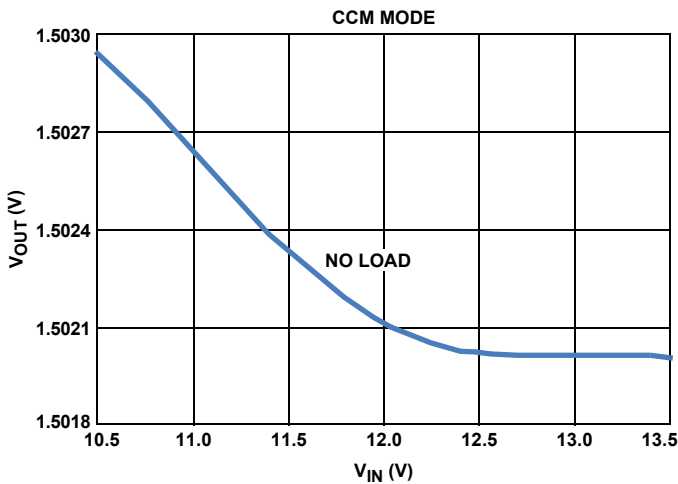

FIGURE 8. LINE REGULATION AT NO LOAD CONDITION

Typical Performance Curves Unless otherwise specified, the input voltage is 12V. (Continued)

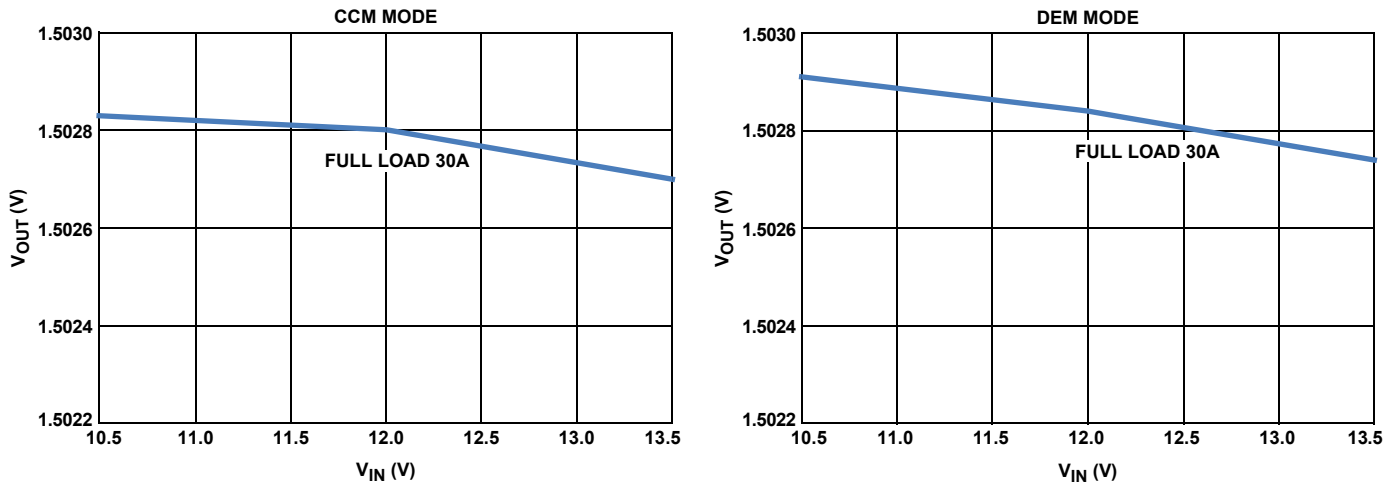

FIGURE 9. LINE REGULATION AT FULL LOAD CONDITION

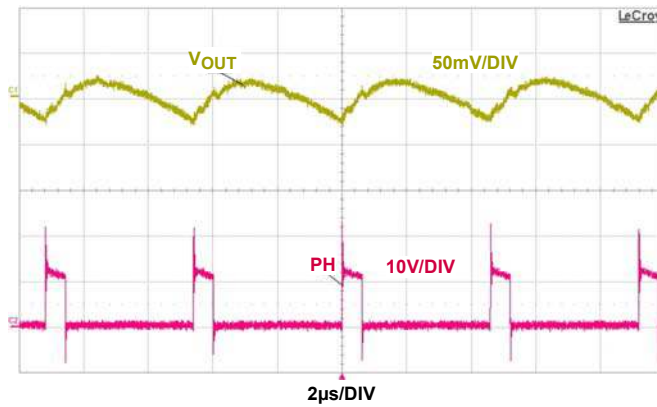

FIGURE 10. OUTPUT VOLTAGE RIPPLE AT 30A LOAD CONDITION

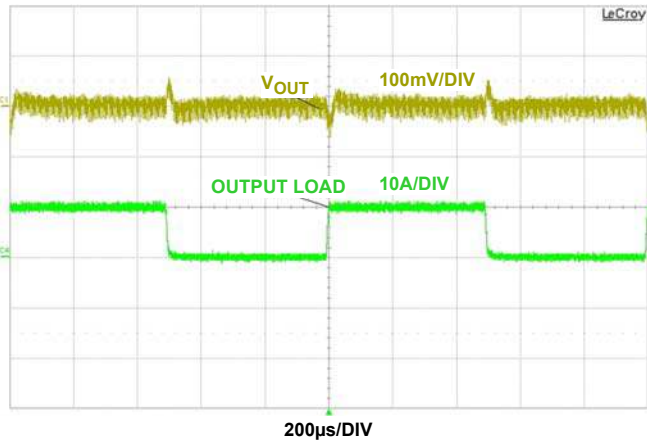

FIGURE 11. 0A-10A; 2A/µs AT CCM MODE

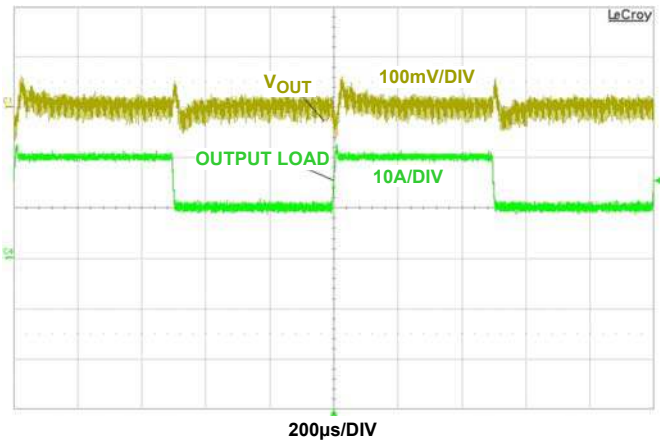

FIGURE 12. 10A -20A; 2A/µs AT CCM MODE

Typical Performance Curves Unless otherwise specified, the input voltage is 12V. (Continued)

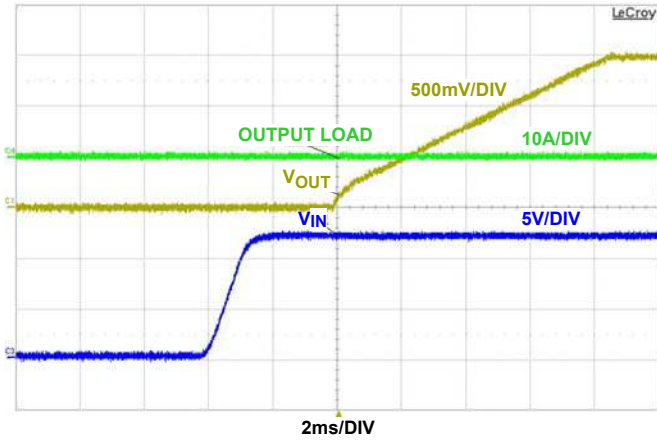

FIGURE 13. START-UP AT 0A LOAD CONDITION

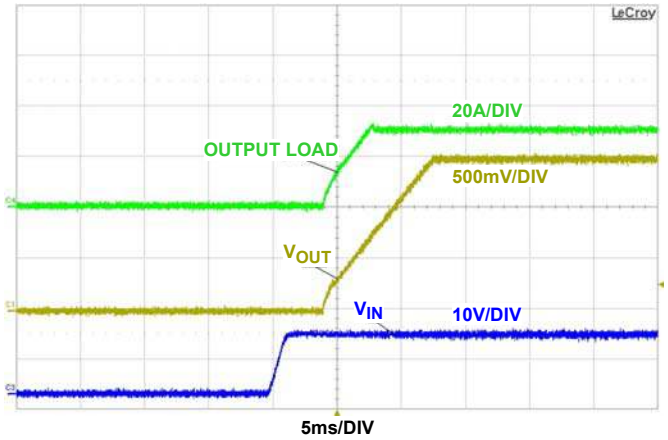

FIGURE 14. START-UP AT 30A LOAD CONDITION

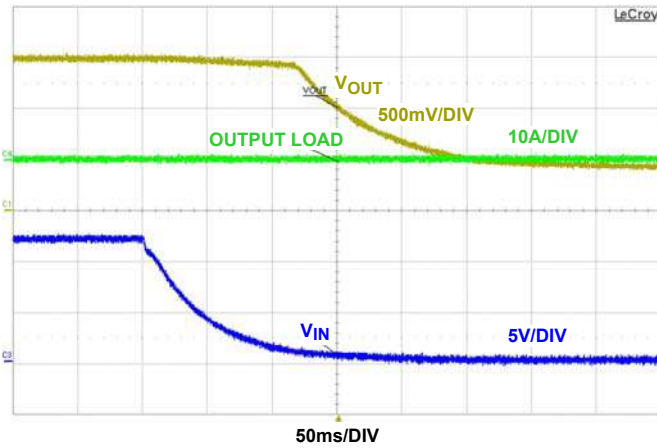

FIGURE 15. SHUTDOWN AT 0A LOAD CONDITION

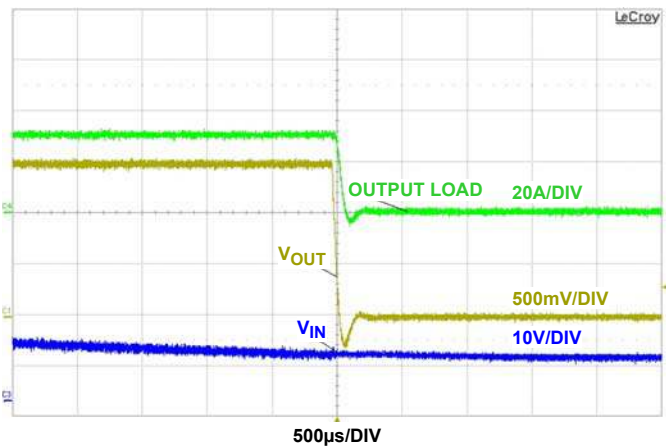

FIGURE 16. SHUTDOWN AT 30A LOAD CONDITION

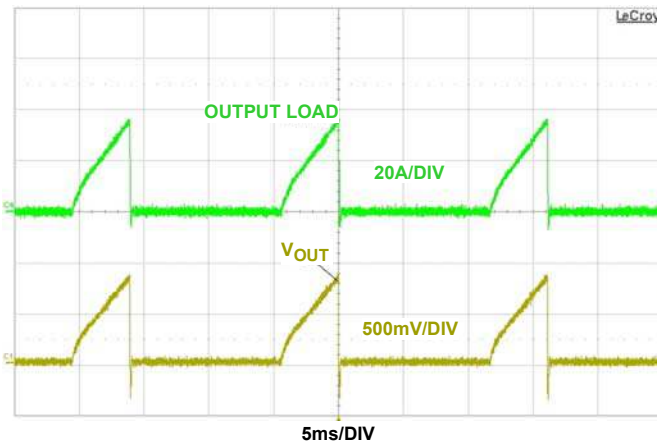

FIGURE 17. OCP AT 34A LOAD

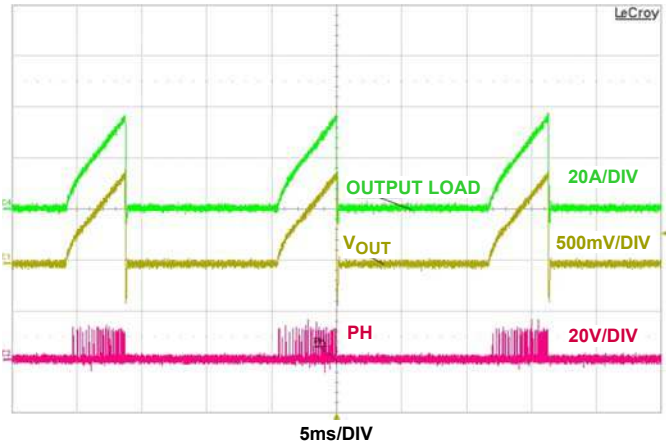
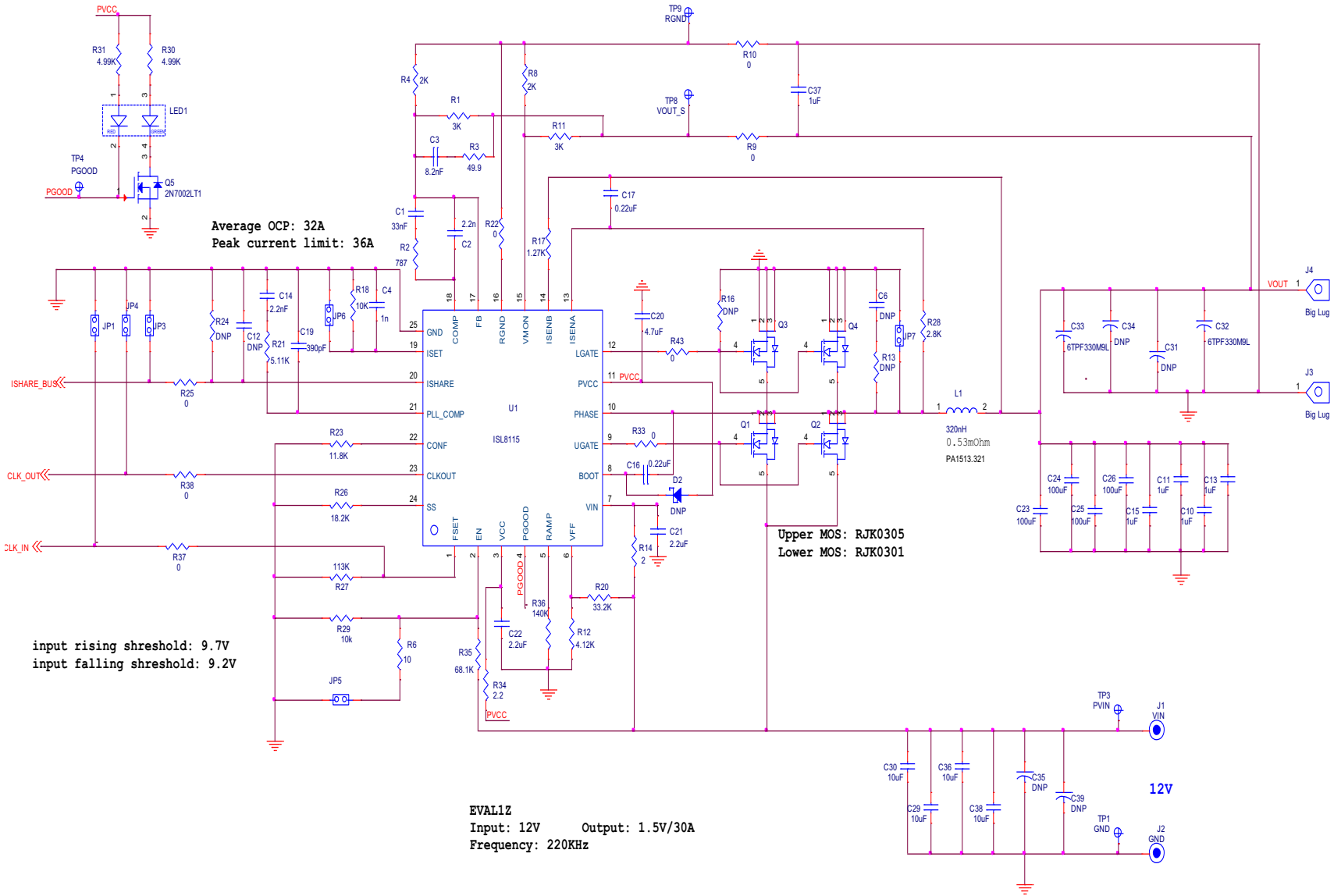

FIGURE 18. SHORT PROTECTION

Schematic



Bill of Materials

QTY	REFERENCE	VALUE	DESCRIPTION	PART #	VENDOR
1	C1	33nF	CAP CER 0.033µF 50V 10% X7R 0603	Generic	Generic
1	C2	2.2n	CAP CER 2200pF 50V 5% NPO 0603	Generic	Generic
1	C3	8.2n	CAP CER 8200pF 50V 5% NPO 0603	Generic	Generic
1	C4	1n	CAP CER 1000pF 50V 5% NPO 0603	Generic	Generic
5	C6, C12, R13, R16, R24	DNP		Generic	Generic
5	C10, C11, C13, C15, C37	1µF	CAP CER 1µF 10V 10% X5R 0603	Generic	Generic
1	C14	2.2nF	CAP CER 2200pF 50V 5% NPO 0603	Generic	Generic
2	C16, C17	0.22µF	CAP CER 0.22µF 16V 10% X7R 0603	Generic	Generic
1	C19	390pF	CAP CER 390pF 50V 5% NPO 0603	Generic	Generic
1	C20	4.7µF	CAP CER 4.7µF 6.3V 10% X5R 0805	Generic	Generic
1	C21	2.2µF	CAP CER 2.2µF 25V 10% X7R 1210	C3225X7R1E225K/1.60	TDK
1	C22	2.2µF	CAP CER 2.2µF 6.3V 20% X5R 0603	Generic	Generic
4	C23, C24, C25, C26	100µF	CAP CER 100µF 6.3V 20% X5R 1210	C3225X5R0J107M250AC	TDK
4	C29, C30, C36, C38	10µF	CAP CER 10µF 50V 10% X5R 1206	C3216X5R1H106K160AB	TDK
2	C31, C34	DNP	CAP TANT 330µF 6.3V 20% 2917	6TPF330M9L	Panasonic
2	C32, C33	6TPF330M9L	CAP TANT 330µF 6.3V 20% 2917	6TPF330M9L	Panasonic
2	C35, C39	DNP	CAP OS-CON 270µF 16V	16SEPC270MX	Panasonic
1	D2	DNP	DIODE SCHOTTKY 40V SOD123		
6	JP1, JP3, JP4, JP5, JP6, JP7	Jumper	JUMPER PLUG 2POS DOUBLE ROW	XG8T-0231	Omron
1	J1	VIN	POST BINDING BANANA INSULATED RE	111-0707-001	Johnson Components
1	J2	GND	POST BINDING BANANA INSULATED BL	111-0703-001	Johnson Components
2	J3, J4	Big Lug	CONN- Big Lug TERMINAL POST	KPA8CTP	Burndy
1	LED1	LXA3025IGC-TR	LED	LNJ162C3XRA	Panasonic
1	L1	320nH	INDUCT PWR 320NH SMD	PA1513.321	Pulse
2	Q1, Q2	RJK0305	MOSFET N-CH 30V 30A 5-LPAK	RJK0305DPB-00#J0	Renesas
2	Q3, Q4	RJK0328	MOSFET N-CH 30V 30A 5-LPAK	RJK0305DPB-00#J0	Renesas
1	Q5	2N7002LT1	MOSFET N-CH 60V 115mA SOT-23	2N7002LT1	ON Semiconductor
2	R1, R11	3k	RES 3.00kΩ 1/10W 1% 0603 SMD	Generic	Generic
1	R2	787	RES 787Ω 1/10W 1% 0603 SMD	Generic	Generic
1	R3	49.9	RES 49.9Ω 1/10W 1% 0603 SMD	Generic	Generic
2	R4, R8	2k	RES 2.00kΩ 1/10W 1% 0603 SMD	Generic	Generic
1	R6	10	RES 10Ω 1/10W 1% 0603 SMD	Generic	Generic
8	R9, R10, R22, R25, R33, R37, R38, R43	0	RES 0.0Ω 1/10W JUMP 0603 SMD	Generic	Generic
1	R12	4.12k	RES 4.12kΩ 1/10W 1% 0603 SMD	Generic	Generic
1	R14	2	RES 2.00Ω 1/4W 1% 1206 SMD	Generic	Generic
1	R17	1.27k	RES 1.27kΩ 1/10W 1% 0603 SMD	Generic	Generic
2	R18, R29	10k	RES 10kΩ 1/10W 1% 0603 SMD	Generic	Generic
1	R20	33.2k	RES 33.2kΩ 1/10W 1% 0603 SMD	Generic	Generic
1	R21	5.11k	RES 5.11kΩ 1/10W 1% 0603 SMD	Generic	Generic

Bill of Materials (Continued)

QTY	REFERENCE	VALUE	DESCRIPTION	PART #	VENDOR
1	R23	11.8k	RES 11.8kΩ 1/10W 1% 0603 SMD	Generic	Generic
1	R26	18.2k	RES 18.2kΩ 1/10W 1% 0603 SMD	Generic	Generic
1	R27	113k	RES 113kΩ 1/10W 1% 0603 SMD	Generic	Generic
1	R28	2.8k	RES 2.8kΩ 1/10W 1% 0603 SMD	Generic	Generic
2	R30, R31	4.99K	RES 4.99kΩ 1/10W 1% 0603 SMD	Generic	Generic
1	R34	2.2	RES 2.2Ω 1/10W 1% 0603 smD	Generic	Generic
1	R35	68.1k	RES 68.1kΩ 1/10W 1% 0603 SMD	Generic	Generic
1	R36	140k	RES 140kΩ 1/10W 1% 0603 SMD	Generic	Generic
1	TP1	GND	Test point	SPCJ-123-01	Jolo
1	TP3	PVIN	Test point	SPCJ-123-01	Jolo
1	TP4	PGOOD	Test point	SPCJ-123-01	Jolo
1	TP8	VOUT_S	Test point	SPCJ-123-01	Jolo
1	TP9	RGND	Test point	SPCJ-123-01	Jolo
1	U1	ISL8115	Sync Buck PWM Controller 24Ld QFN	ISL8115FRTZ	Intersil

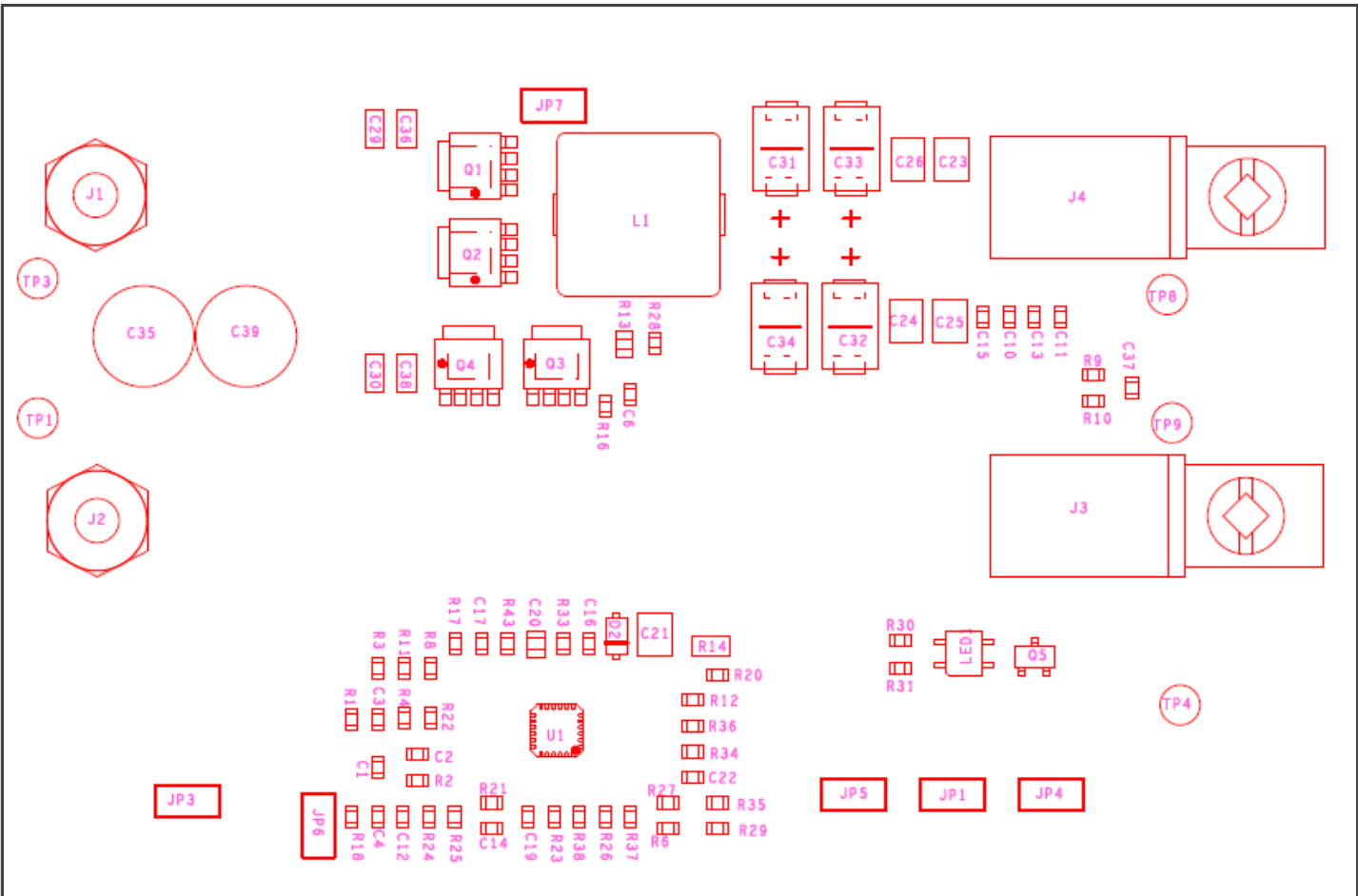

Assembly Drawing

PCB Layout

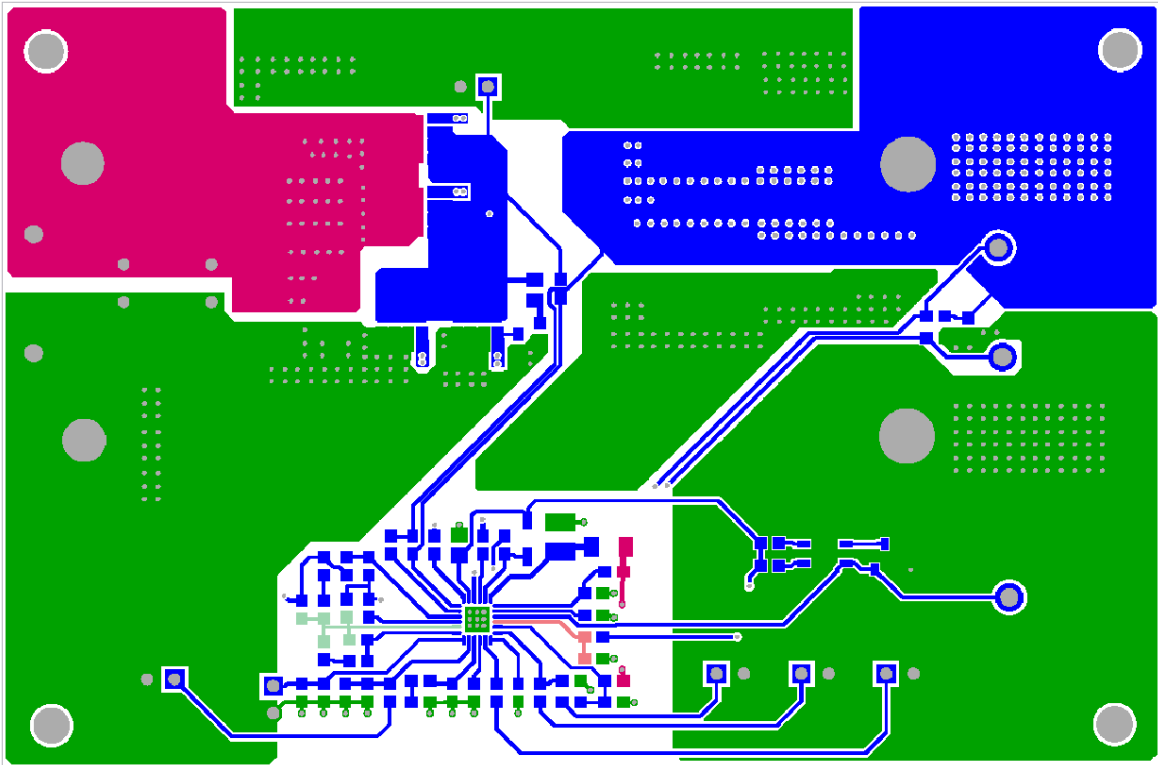

FIGURE 19. TOP LAYER

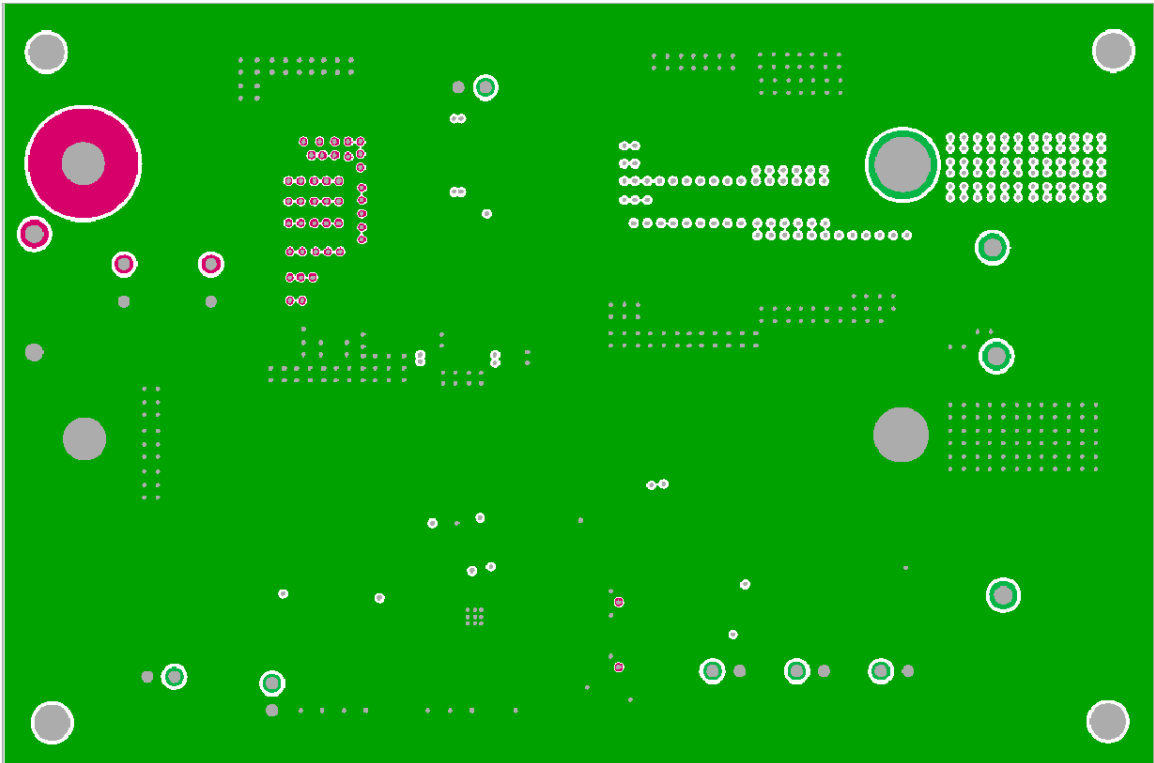

FIGURE 20. LAYER 2

PCB Layout (Continued)

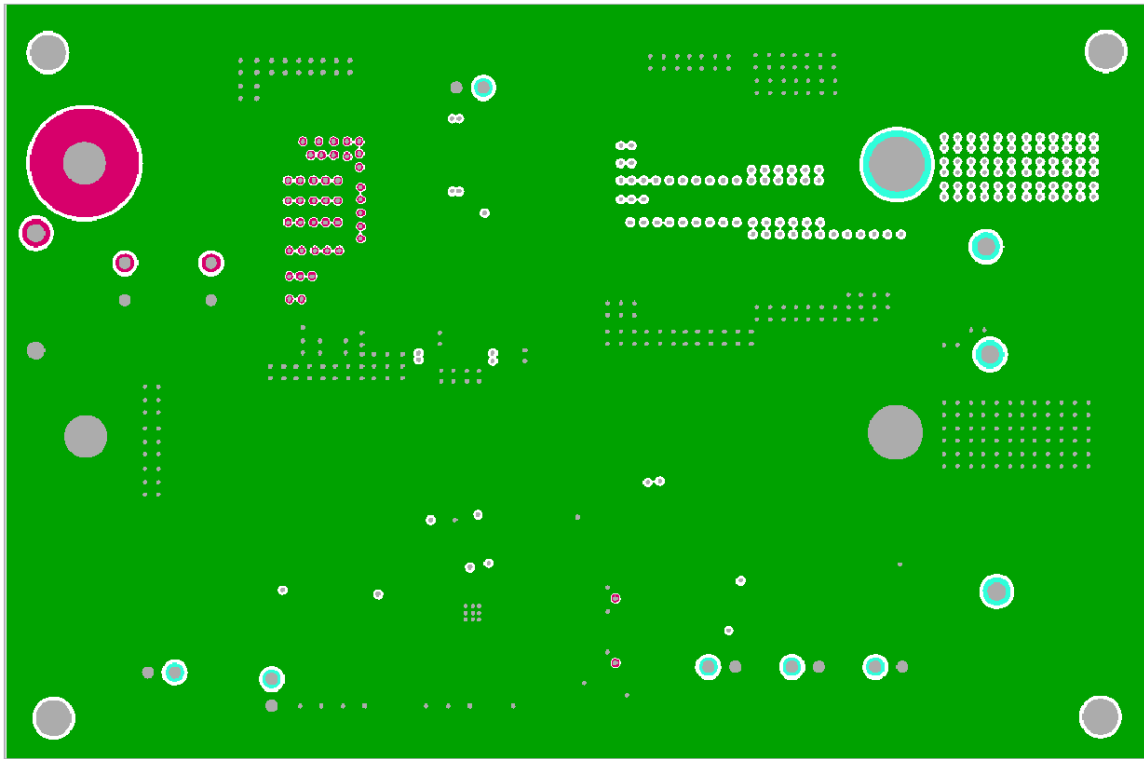

FIGURE 21. LAYER 3

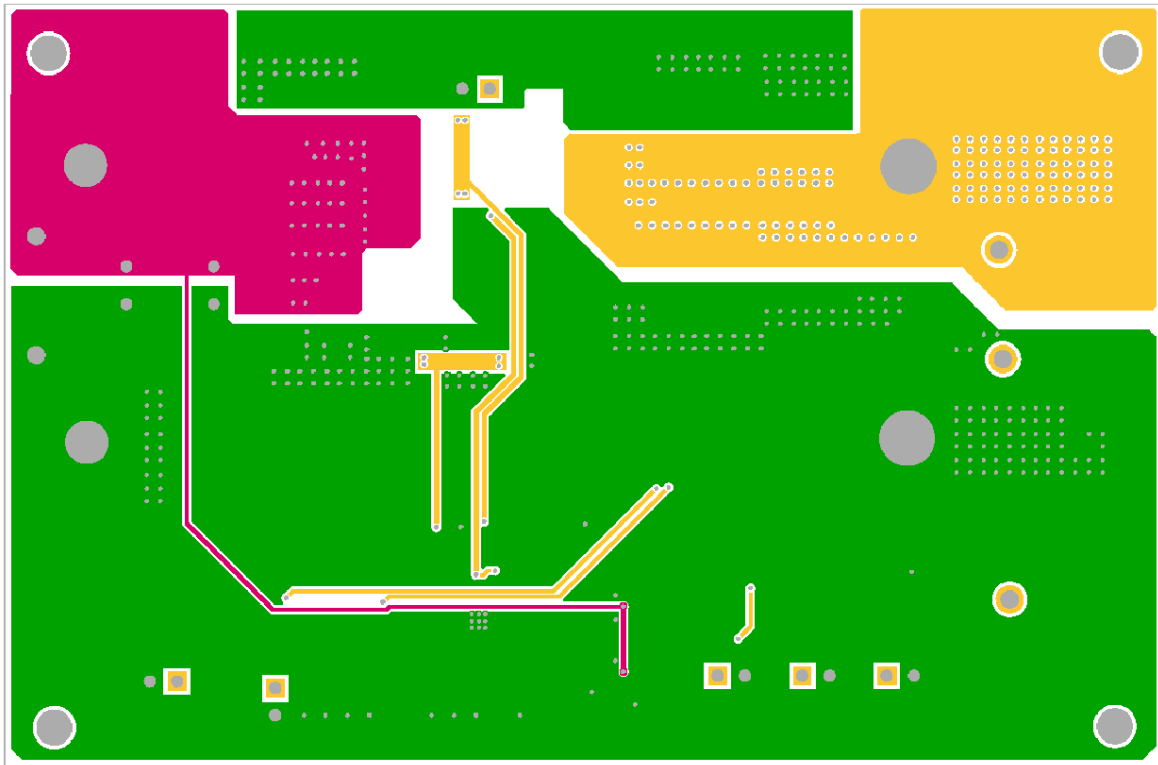

FIGURE 22. LAYER 4

Notice

1. Descriptions of circuits, software and other related information in this document are provided only to illustrate the operation of semiconductor products and application examples. You are fully responsible for the incorporation or any other use of the circuits, software, and information in the design of your product or system. Renesas Electronics disclaims any and all liability for any losses and damages incurred by you or third parties arising from the use of these circuits, software, or information.
2. Renesas Electronics hereby expressly disclaims any warranties against and liability for infringement or any other claims involving patents, copyrights, or other intellectual property rights of third parties, by or arising from the use of Renesas Electronics products or technical information described in this document, including but not limited to, the product data, drawings, charts, programs, algorithms, and application examples.
3. No license, express, implied or otherwise, is granted hereby under any patents, copyrights or other intellectual property rights of Renesas Electronics or others.
4. You shall not alter, modify, copy, or reverse engineer any Renesas Electronics product, whether in whole or in part. Renesas Electronics disclaims any and all liability for any losses or damages incurred by you or third parties arising from such alteration, modification, copying or reverse engineering.
5. Renesas Electronics products are classified according to the following two quality grades: "Standard" and "High Quality". The intended applications for each Renesas Electronics product depends on the product's quality grade, as indicated below.
"Standard": Computers; office equipment; communications equipment; test and measurement equipment; audio and visual equipment; home electronic appliances; machine tools; personal electronic equipment; industrial robots; etc.
"High Quality": Transportation equipment (automobiles, trains, ships, etc.); traffic control (traffic lights); large-scale communication equipment; key financial terminal systems; safety control equipment; etc.
Unless expressly designated as a high reliability product or a product for harsh environments in a Renesas Electronics data sheet or other Renesas Electronics document, Renesas Electronics products are not intended or authorized for use in products or systems that may pose a direct threat to human life or bodily injury (artificial life support devices or systems; surgical implantations; etc.), or may cause serious property damage (space system; undersea repeaters; nuclear power control systems; aircraft control systems; key plant systems; military equipment; etc.). Renesas Electronics disclaims any and all liability for any damages or losses incurred by you or any third parties arising from the use of any Renesas Electronics product that is inconsistent with any Renesas Electronics data sheet, user's manual or other Renesas Electronics document.
6. When using Renesas Electronics products, refer to the latest product information (data sheets, user's manuals, application notes, "General Notes for Handling and Using Semiconductor Devices" in the reliability handbook, etc.), and ensure that usage conditions are within the ranges specified by Renesas Electronics with respect to maximum ratings, operating power supply voltage range, heat dissipation characteristics, installation, etc. Renesas Electronics disclaims any and all liability for any malfunctions, failure or accident arising out of the use of Renesas Electronics products outside of such specified ranges.
7. Although Renesas Electronics endeavors to improve the quality and reliability of Renesas Electronics products, semiconductor products have specific characteristics, such as the occurrence of failure at a certain rate and malfunctions under certain use conditions. Unless designated as a high reliability product or a product for harsh environments in a Renesas Electronics data sheet or other Renesas Electronics document, Renesas Electronics products are not subject to radiation resistance design. You are responsible for implementing safety measures to guard against the possibility of bodily injury, injury or damage caused by fire, and/or danger to the public in the event of a failure or malfunction of Renesas Electronics products, such as safety design for hardware and software, including but not limited to redundancy, fire control and malfunction prevention, appropriate treatment for aging degradation or any other appropriate measures. Because the evaluation of microcomputer software alone is very difficult and impractical, you are responsible for evaluating the safety of the final products or systems manufactured by you.
8. Please contact a Renesas Electronics sales office for details as to environmental matters such as the environmental compatibility of each Renesas Electronics product. You are responsible for carefully and sufficiently investigating applicable laws and regulations that regulate the inclusion or use of controlled substances, including without limitation, the EU RoHS Directive, and using Renesas Electronics products in compliance with all these applicable laws and regulations. Renesas Electronics disclaims any and all liability for damages or losses occurring as a result of your noncompliance with applicable laws and regulations.
9. Renesas Electronics products and technologies shall not be used for or incorporated into any products or systems whose manufacture, use, or sale is prohibited under any applicable domestic or foreign laws or regulations. You shall comply with any applicable export control laws and regulations promulgated and administered by the governments of any countries asserting jurisdiction over the parties or transactions.
10. It is the responsibility of the buyer or distributor of Renesas Electronics products, or any other party who distributes, disposes of, or otherwise sells or transfers the product to a third party, to notify such third party in advance of the contents and conditions set forth in this document.
11. This document shall not be reprinted, reproduced or duplicated in any form, in whole or in part, without prior written consent of Renesas Electronics.
12. Please contact a Renesas Electronics sales office if you have any questions regarding the information contained in this document or Renesas Electronics products.
(Note 1) "Renesas Electronics" as used in this document means Renesas Electronics Corporation and also includes its directly or indirectly controlled subsidiaries.
(Note 2) "Renesas Electronics product(s)" means any product developed or manufactured by or for Renesas Electronics.

(Rev.4.0-1 November 2017)



SALES OFFICES

Renesas Electronics Corporation

<http://www.renesas.com>

Refer to "<http://www.renesas.com/>" for the latest and detailed information.

Renesas Electronics America Inc.
1001 Murphy Ranch Road, Milpitas, CA 95035, U.S.A.
Tel: +1-408-432-8888, Fax: +1-408-434-5351

Renesas Electronics Canada Limited
9251 Yonge Street, Suite 8309 Richmond Hill, Ontario Canada L4C 9T3
Tel: +1-905-237-2004

Renesas Electronics Europe Limited
Dukes Meadow, Millboard Road, Bourne End, Buckinghamshire, SL8 5FH, U.K
Tel: +44-1628-651-700, Fax: +44-1628-651-804

Renesas Electronics Europe GmbH
Arcadiastrasse 10, 40472 Düsseldorf, Germany
Tel: +49-211-6503-0, Fax: +49-211-6503-1327

Renesas Electronics (China) Co., Ltd.
Room 1709 Quantum Plaza, No.27 ZhichunLu, Haidian District, Beijing, 100191 P. R. China
Tel: +86-10-8235-1155, Fax: +86-10-8235-7679

Renesas Electronics (Shanghai) Co., Ltd.
Unit 301, Tower A, Central Towers, 555 Langao Road, Putuo District, Shanghai, 200333 P. R. China
Tel: +86-21-2226-0888, Fax: +86-21-2226-0999

Renesas Electronics Hong Kong Limited
Unit 1601-1611, 16/F., Tower 2, Grand Century Place, 193 Prince Edward Road West, Mongkok, Kowloon, Hong Kong
Tel: +852-2265-6688, Fax: +852-2886-9022

Renesas Electronics Taiwan Co., Ltd.
13F, No. 363, Fu Shing North Road, Taipei 10543, Taiwan
Tel: +886-2-8175-9600, Fax: +886-2-8175-9670

Renesas Electronics Singapore Pte. Ltd.
80 Bendemeer Road, Unit #06-02 Hyflux Innovation Centre, Singapore 339949
Tel: +65-6213-0200, Fax: +65-6213-0300

Renesas Electronics Malaysia Sdn.Bhd.
Unit 1207, Block B, Menara Amcorp, Amcorp Trade Centre, No. 18, Jln Persiaran Barat, 46050 Petaling Jaya, Selangor Darul Ehsan, Malaysia
Tel: +60-3-7955-9390, Fax: +60-3-7955-9510

Renesas Electronics India Pvt. Ltd.
No.777C, 100 Feet Road, HAL 2nd Stage, Indiranagar, Bangalore 560 038, India
Tel: +91-80-67208700, Fax: +91-80-67208777

Renesas Electronics Korea Co., Ltd.
17F, KAMCO Yangjae Tower, 262, Gangnam-daero, Gangnam-gu, Seoul, 06265 Korea
Tel: +82-2-558-3737, Fax: +82-2-558-5338