

## Sensor/actuator box - SACB-4/ 4-C SCO - 1516849

Please be informed that the data shown in this PDF Document is generated from our Online Catalog. Please find the complete data in the user's documentation. Our General Terms of Use for Downloads are valid (<http://download.phoenixcontact.com>)



Sensor/actuator box, Connection method: M12-SPEEDCON-socket Metal, Number of slots: 4, Number of positions: 4, Slot assignment: Single, Status indication: No, Universal; Master cable connection: Pluggable screw connection 180°, Shielding: No

### Product Features

- ✓ Safety in the field, thanks to molded housing and high degree of protection
- ✓ Flexible, distributed bundling of signals in one master cable
- ✓ Save time, thanks to installation with SPEEDCON fast locking system
- ✓ Flexible: distributor box with connector hood for on-site assembly



### Key commercial data

Packing unit	1 PCE
Weight per Piece (excluding packing)	248.2 GRM
Custom tariff number	85366990
Country of origin	Poland

### Technical data

#### General

Rated voltage	120 V
Max. operating voltage $U_{max}$	135 V
Current carrying capacity per I/O signal	2 A
Current carrying capacity per slot	4 A
Total rated current	10 A
	2x 8 A (For electrical isolation)
Number of positions	4
Number of slots	4
Inflammability class according to UL 94	V0
Sensor/actuator connection system	M12-SPEEDCON-socket

## Sensor/actuator box - SACB-4/ 4-C SCO - 1516849

### Technical data

#### Ambient conditions

Degree of protection	IP65
	IP67
	IP69K
Ambient temperature (operation)	-30 °C ... 80 °C

#### Master cable data/connection data

Connection method	Pluggable screw connection
Conductor cross section min. (signal)	0.14 mm <sup>2</sup>
Conductor cross section max. (signal)	1.5 mm <sup>2</sup>
Conductor cross section AWG min. (signal)	26
Conductor cross section AWG max. (signal)	16
Stripping length (signal)	7 mm
Conductor cross section min. (energy)	0.14 mm <sup>2</sup>
Conductor cross section max. (energy)	1.5 mm <sup>2</sup>
Conductor cross section AWG min. (energy)	26
Conductor cross section AWG max. (energy)	16
External cable diameter min.	7 mm
External cable diameter max.	12 mm
Stripping length	50 mm (Master cable)
Tightening torque, cover screw	0.35 Nm
Tightening torque, union nut	2.5 Nm
Tightening torque slot sensor/actuator cable	0.4 Nm

#### Insulation material

Housing material	PBT
Material of the moulding mass	PUR
Contact material	Cu alloy
Contact surface material	Gold-plated
Contact carrier material	PA
Material of contact, master cable side	CU alloy
Material of contact surface, master cable side	Gold-plated
Material of the contact carrier on the master cable side	PA 66 V0
Material of threaded sleeve	Zinc die-cast
Material of threaded sleeve surface	Nickel-plated
Material, O-ring	NBR

#### Pin assignment

Slot/position = Wire color or connection	1 / 4 (A) = 1 / 4
	2 / 4 (A) = 2 / 4

## Sensor/actuator box - SACB-4/ 4-C SCO - 1516849

### Technical data

#### Pin assignment

	3 / 4 (A) = 3 / 4
	4 / 4 (A) = 4 / 4
	1-4 / 1 (+ 120 V) = U <sub>N</sub>
	1-4 / 3 (0 V) = 0 V
	1-4 / 5 (PE) = PE

### Classifications

#### eCl@ss

eCl@ss 4.0	27140815
eCl@ss 4.1	27140815
eCl@ss 5.0	27143423
eCl@ss 5.1	27143423
eCl@ss 6.0	27143423
eCl@ss 7.0	27449001
eCl@ss 8.0	27449001

#### ETIM

ETIM 2.0	EC000200
ETIM 3.0	EC001856
ETIM 4.0	EC002585
ETIM 5.0	EC002585

#### UNSPSC

UNSPSC 6.01	31261501
UNSPSC 7.0901	31261501
UNSPSC 11	31261501
UNSPSC 12.01	31261501
UNSPSC 13.2	31261501

### Approvals

#### Approvals

---

Approvals

UL Recognized / cUL Recognized / GOST / cULus Recognized

---

## Sensor/actuator box - SACB-4/ 4-C SCO - 1516849

### Approvals

Ex Approvals

---

Approvals submitted

---

#### Approval details

UL Recognized 	
Nominal current IN	3 A
Nominal voltage UN	120 V

cUL Recognized 	
Nominal current IN	3 A
Nominal voltage UN	120 V

GOST 	
--	--

cULus Recognized 	
--	--

### Accessories

Accessories

Cable by the meter

## Sensor/actuator box - SACB-4/ 4-C SCO - 1516849

### Accessories

Master cable ring - SACB- 4X0,34/ 3X0,75-50,0 PUR - 1503328



Master cable for sensor/actuator boxes, with PE conductor, unshielded, material PUR/PVC, 7-pos., 4 x 0.34 mm<sup>2</sup> and 3 x 0.75 mm<sup>2</sup>

---

### Connector hood without master cable

Connector hood - SACB-C-H180 8/16 SCO - 1516713



Connector hood with an integrated connector, for M12 sensor/actuator boxes with metal thread and pluggable screw connection, for 4, 6 or 8 slots

---

### Device marking

Contact marker – zack marker strip - SS-ZB 17,5 WH - 0804963



Contact marker – zack marker strip, Strip, white, Unlabeled, Can be labeled with: Plotter, Mounting type: Snap into flat marker groove, Lettering field: 17.5 x 8 mm

---

### Protective cap

Screw plug - PROT-MS SCO - 1553129



M12 screw plug with SPEEDCON quick locking for unoccupied M12 sockets of the sensor/actuator cables, boxes and flush-type connectors

---

### Screwdriver tools

## Sensor/actuator box - SACB-4/ 4-C SCO - 1516849

### Accessories

Tool - SAC BIT M12-D15 - 1208432



Nut for assembling sensor/actuator cables with M12 connector and for M12 connectors with QUICKON fast connection technology, for 4 mm hexagonal drive

---

Tool - SACC BIT M12-D20 - 1208445



Nut for assembling SACC M12 connectors for free assembly, excluding M12 connectors with QUICKON fast connection technology, for 4 mm hexagonal drive

---

Philips screwdriver - SZK PZ1 VDE - 1206450



Screwdriver, PZ crosshead, VDE insulated, size: PZ 1 x 80 mm, 2-component grip, with non-slip grip

---

Torque tool

Torque screwdriver - TSD 04 SAC - 1208429



Torque screwdriver, with preset torque of 0.4 Nm and 4 mm hexagonal drive for M12 connectors

---

Drawings

# Sensor/actuator box - SACB-4/ 4-C SCO - 1516849

Schematic diagram

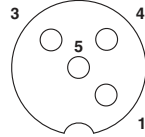

M12 slot, socket, 4-pos.

Schematic diagram

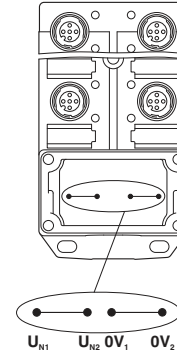

Potential  $U_{N1}$  and  $U_{N2}$  bridged. Potential assignment:  $U_{N1} = U_{N2} =$  slots 1,2,3,4.

Schematic diagram

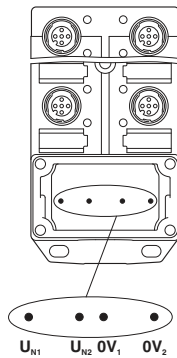

Electrically isolated. Potential assignment:  $U_{N1} =$  slots 1,3 and  $U_{N2} =$  slots 2,4.

Dimensioned drawing

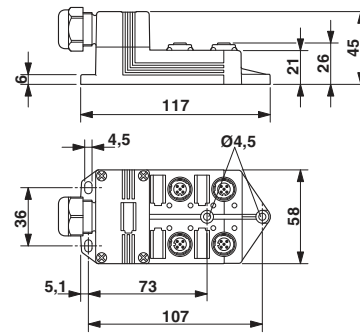

Circuit diagram

