

# Vanadium Pentoxide Lithium Coin Batteries (VL Series): Individual Specifications

## VL621

### ■ Dimensions(mm)

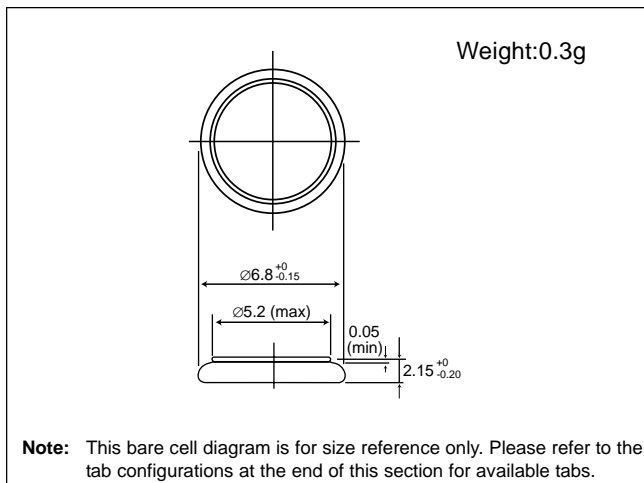

### ■ Specification

Nominal voltage (V)	3
Nominal capacity (mAh)	1.5
Continuous standard load (mA)	0.01
Operating temperature (C)	-20 ~ +60

### ■ Discharge Temperature Characteristics

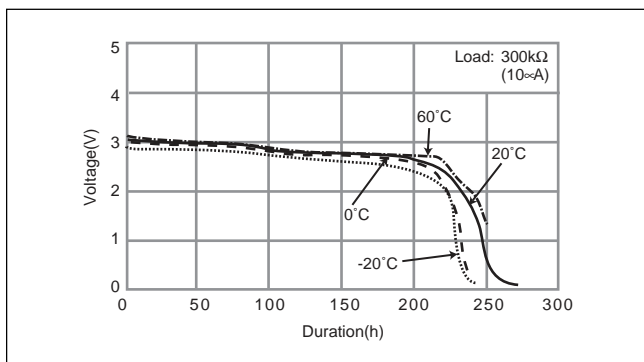

### ■ Consumption current vs. Duration time

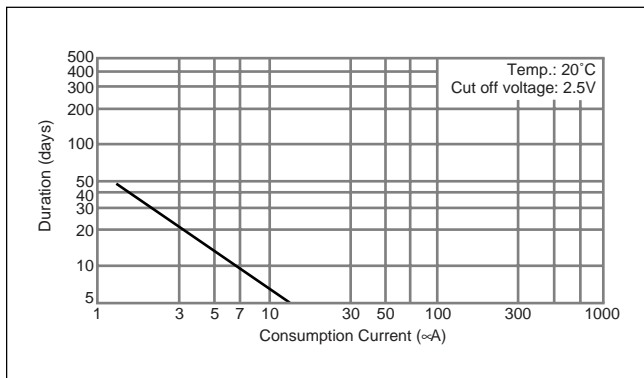

## VL1216

### ■ Dimensions(mm)

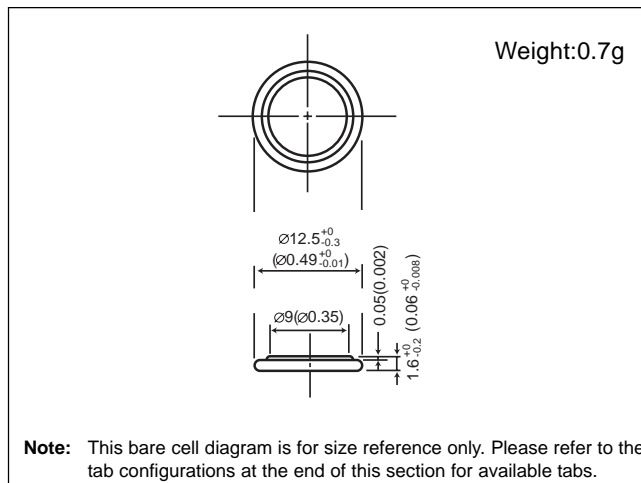

### ■ Specification

Nominal voltage (V)	3
Nominal capacity (mAh)	5.0
Continuous standard load (mA)	0.03
Operating temperature (C)	-20 ~ +60

### ■ Discharge Temperature Characteristics

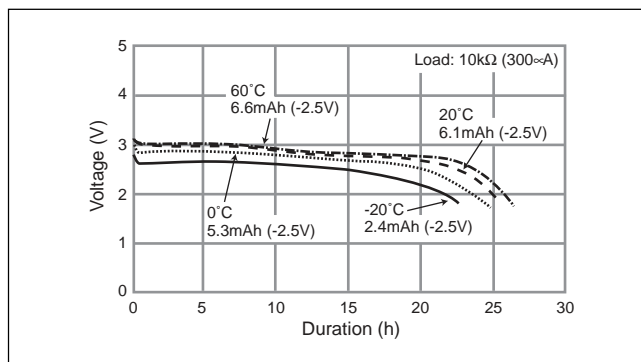

### ■ Consumption current vs. Duration time

